



**2016
MASTER
CATALOG**



BROWNING[®]

AMMUNITION

New for 2016

BROWNINGAMMO.COM



To some people the name Browning means accuracy, to others dependability, and to others it means heritage. To us, it represents a legacy of innovation that we can trace straight back to John Moses Browning and his humble beginnings in Ogden, Utah, just down the road from our current headquarters.

Browning’s legacy of innovation can be found in the Model 1911-380, descended from one of The Master’s most enduring designs. A “Sweet Sixteen” version of the A5 brings new life to the versatile 16 gauge. Our advances in autoloading rifle technology continue with the new BAR MK 3, the latest evolution of this classic sporting rifle.

While Browning is best known for guns, for more than a half century we have provided hunters and shooters with the finest in outerwear, security safes, knives and flashlights, all designed to make outdoor pursuits more enjoyable and productive. In 2016, our tradition of offering high quality products continues with new introductions in every category. Welcome to Browning 2016.

- SHOTGUNS** 2
- HIGH GRADE PROGRAM** 6
- CITORI 725 PRO** 10
- CITORI 725** 14
- CITORI** 18
- CYNERGY** 22
- BT-99** 28
- A5** 30
- MAXUS** 36
- SILVER** 40
- BPS** 44
- 10 GAUGE** 48
- EXTRA BARRELS** 49
- RIFLES** 50
- X-BOLT** 52
- AB3** 64
- BLR** 68
- BAR** 72
- T-BOLT** 76
- BL-22** 78
- SA-22** 80
- BUCK MARK RIFLE** 82
- HANDGUNS** 84
- BUCK MARK** 86
- 1911-22** 90
- 1911-380** 94
- HI POWER** 98
- CUSTOM SHOP** 100
- SAFES** 104
- OUTDOOR GEAR** 138
- GUN CASES AND SHOOTING BAGS** 140
- SLINGS** 160
- SHOOTING ACCESSORIES** 165
- MAGAZINES** 168
- RINGS AND BASES** 170
- SIGHTS** 172
- BOSS-CR** 173
- CHOKE TUBES** 174
- HEARING AND EYE PROTECTION** 180
- GUN MAINTENANCE** 184
- DECALS** 186
- KNIVES** 188
- LIGHTS** 214
- APPAREL** 230
- HELL’S CANYON SPEED BIG GAME** 234
- HELL’S CANYON BIG GAME** 246
- WASATCH BIG GAME** 254
- BRANDED LIFESTYLE** 258
- WICKED WING WATERFOWL** 264
- PHEASANTS FOREVER UPLAND** 274
- BIRD’N LITE UPLAND** 276
- HUNTING VESTS** 278
- SHOOTING VESTS/GEAR** 280
- SHOOTING SHIRTS** 288
- RANGE WEAR/COMPETITION GEAR** 289
- CAPS** 292
- PROSTAFF** 306
- LICENSED PRODUCTS** 314



THE BROWNING SHOTGUN LEGEND.

Nearly every shooter has a great Browning shotgun story. The tales range from blustery mornings in layout boats to late summer dove hunts around a waterhole. Simply mentioning the name Browning sends some folks back in time to that first goose hunt with their grandpa's Auto-5 or to that first clay shattered with a BT-99 rented from the range. We hear these stories every day from customers and enthusiasts that share the Browning bond.

Maybe you are researching your first Browning shotgun — or maybe your fifth. Regardless, you understand and appreciate the quality and performance proven by generations of past and present shooters.

SHOTGUNS

TOTAL BARREL DYNAMICS — FROM EXPERIMENTATION TO SCIENCE

- Our engineers have fired literally millions of shells in order to improve the relationship between the shotgun barrel and shotshell. What began as experiments have become the science of shot pattern performance.
- Extensive testing has shown that shot is deformed as it passes through the restrictions of the forcing cone, a tight bore and the choke tube. When shot is deformed it is less stable in flight, leading to flyers and holes in patterns. Our Vector Pro lengthened forcing cone is designed to reduce stress on the shot column, and Back-Bored Technology allows the shot column to exit the barrel at maximum velocity. Our proven choke tube technologies further minimize the stress placed on the shot as it exits the barrel while constricting it to the pattern you need. Other manufacturers use shorter forcing cones that deform the shot, a bore that is too tight or loose, or shorter choke tubes that result in inferior pattern performance.
- Total Barrel Dynamics — standard on A5, Maxus, BT-99 and on 12 and 20 gauge Citori and Cynergy models — is a system of technologies that function together to reduce shot deformation and significantly improve pattern consistency and performance. Each component of Total Barrel Dynamics plays a part in keeping shot patterns whole and pellets on target, and to ignore any single part weakens performance.

CHAMBER

FEATHER TECHNOLOGY

HEAVY DUTY, LIGHT WEIGHT

- Feather technology significantly reduces the weight of an over and under shotgun (approximately one pound) by using a high quality alloy for the receiver rather than steel.
- To maintain maximum durability, the breech face is a dovetailed steel insert.
- Citori models also use a full-width steel hinge pin and Cynergy shotguns feature steel MonoLock Hinge surfaces to resist wear.

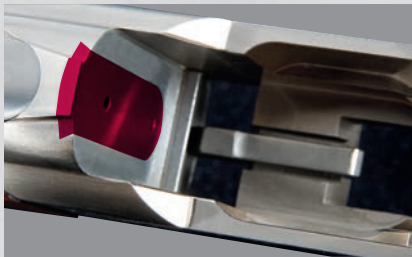

STEEL BREECH FACE

All Feather models feature a steel breech face that resists wear, allowing the receiver to be built from weight-saving alloy.

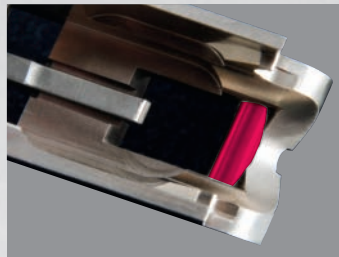

CITORI STEEL HINGE PIN

The full-width, steel hinge pin in the Citori provides maximum strength and lasting endurance.



CYNERGY STEEL INSERTS

To ensure longevity, steel inserts are added to the MonoLock Hinge.

RECOIL REDUCTION TECHNOLOGIES



INFLEX TECHNOLOGY RECOIL PAD

- Inflex recoil pads incorporate directional deflection construction that guides the comb down and away from your face, reducing felt recoil for greater shooting comfort and faster, more accurate follow-up shots.
- The Inflex recoil pads are made from a soft material for the best recoil absorbing performance available.

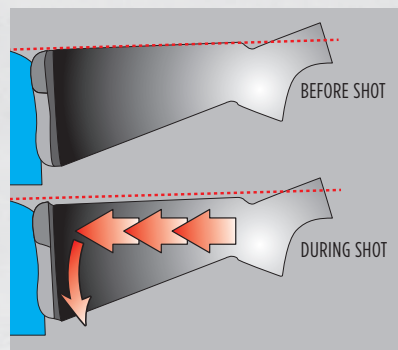

FOR SMALLER SHOOTERS

MICRO MIDAS FIREARMS

- Micro Midas firearms are specifically designed to give younger or smaller shooters a high quality, great fitting firearm.
- Micro Midas firearms are constructed with the same quality components and attention to detail as all Browning firearms.

BROWNING GROWTH INSURANCE PROGRAM

- Micro and Micro Midas models are eligible for the Growth Insurance Program that allows new owners to purchase a full-size stock at 50% off the retail price.
- Growth Insurance allows Micro and Micro Midas firearms to grow with the shooter.
- Offers you a higher rate of return on your firearm investment.
- Visit browning.com for complete details.



STOCK FINISHES

MAXIMUM GRIP

- Dura-Touch Armor Coating is extremely durable.
- Improves grip in wet and cold conditions.

DURA-TOUCH
Armor Coating



FLOATING RIB

MORE CONSISTENCY

- The floating rib allows the rib and barrel to expand independently to eliminate stress.
- Prevents changes to point of impact due to barrel heating and the rib staying cool.



FORCING CONE

BORE



CHOKE TUBE

VECTORPRO™

BACK-BORED TECHNOLOGY

INVECTOR-DS

INVECTOR-Plus™

VECTOR PRO

LONGER IS BETTER. THE ADVANTAGES OF A LENGTHENED FORCING CONE

- The forcing cone is the tapered transition between the chamber and the bore that constricts the shot column. The longer the forcing cone is, the more gradual the constriction.
- A gradual constriction reduces stress on the shot column as it passes into the bore, resulting in fewer deformed pellets. Less pellet deformation produces more uniform patterns and keeps more pellets in the central part of the pattern. Vector Pro is better than the competitors' forcing cone designs because of the more gradual constriction.
- Lengthening forcing cones is a popular and expensive aftermarket practice done to increase shot pattern performance. But it comes standard on A5, Maxus, BT-99 and on 12 and 20 gauge Citori 725, Citori and Cynergy models.

BACK-BORED TECHNOLOGY

WHAT IS BACK-BORING?

- Back-boring enlarges the bore to the maximum diameter to increase shot velocity, minimize pellet deformity for more uniform patterns and reduce felt recoil.
- Extensive testing has shown that Back-Bored Technology reduces the friction between the shot cup and the bore, but does not allow gases to slip past the shot cup that would result in reduced pellet velocity and blown patterns.
- Back-Bore Technology specifications minimize shot deformation and maximize pattern uniformity, consistency and density. Back-Bored Technology is standard on A5, Maxus, BT-99 and on 12 and 20 gauge Citori 725, Citori, Cynergy, BPS and Silver models.

INVECTOR-DS

TAKING CHOKE TUBES TO THE MAX

- Invector-DS choke tubes combine muzzle-end threads and thin-wall construction for a longer, more gradually tapered choke tube that produces extremely consistent, dense shot patterns.
- From Cylinder to Extra Full, Invector-DS shot patterns tighten consistently in reliable, evenly scaled steps.
- Muzzle threads minimize the flare at the end of the barrel for improved shotgun appearance. A slightly lighter overall barrel weight is achieved for faster swinging and improved balance.
- The more gradual taper of Invector-DS choke tubes reduces shot deformation for fewer flyers and gaps in the pattern and allows higher shot velocities for hard hitting performance.
- The "DS" stands for double-seal. Our proprietary differential-banded brass seal compresses against the barrel wall to keep the choke tube threads clean and make installation and removal easier than any other muzzle thread system.
- Invector-DS is standard on A5 and Citori 725 models.
- View the full line of Invector-DS choke tubes on pages 175 and 177.

STANDARD INVECTOR™

STANDARD INVECTOR

PATTERN VERSATILITY FOR 10 GA., 16 GA., 28 GA. AND .410 BORE SHOTGUNS

- The Standard Invector interchangeable choke tube system offers consistent, dense shot patterns with the constriction needed for the shooting situation.
- Threads on the breech end help prevent gases from slipping between the choke tube and barrel that could damage the choke tube and the barrel.
- Standard Invector is standard on 10, 16 and 28 gauge, and .410 bore Citori, Cynergy, Gold and BPS models.
- See pages 175 through 178 for a complete listing of choke tubes.

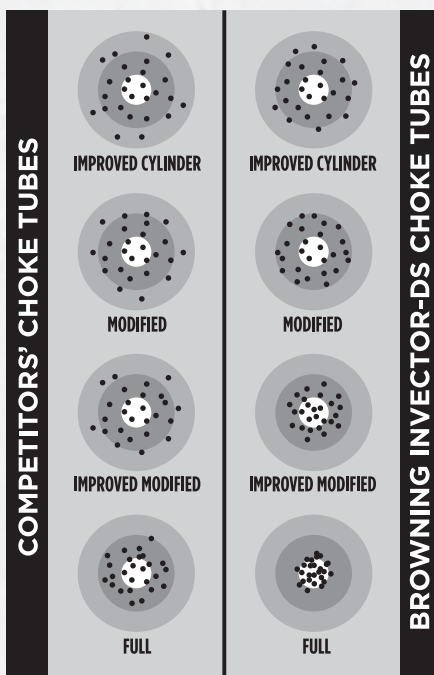

INVECTOR-DS CHOKE TUBES VS. COMPETITORS' CHOKE TUBES

Invector-DS tubes have even pattern percentage increments, offering just the right pattern for any shooting situation.

Competitors' choke tubes show little pattern difference between choke constrictions.

INVECTOR-PLUS

CHAMPIONSHIP PROVEN PERFORMANCE

- Invector-Plus started the long choke tube revolution. An ever-growing collection of championship medals is proof of its patterning performance.
- The Invector-Plus choke tube system works with Vector Pro and Back-Bored Technology to offer consistent, dense shot patterns with the constriction needed for the shooting situation.
- The long choke taper inside an Invector-Plus choke tube produces consistent patterns with more uniform densities and fewer flyers.
- Threads on the breech end help prevent gases from slipping between the choke tube and barrel that could damage the choke tube and the barrel.
- Invector-Plus is standard on 12 and 20 gauge Maxus, Citori, Cynergy, Silver, BPS and BT-99 models.
- View the full line of Invector-Plus choke tubes on pages 175 through 178.

ALL BROWNING FIREARMS ARE SHIPPED WITH A FREE LOCKING DEVICE TO ASSIST IN THE SAFE STORAGE OF FIREARMS.

THE BROWNING HIGH GRADE PROGRAM — YEAR FOUR.

The intricately engraved, beautifully finished, small gauge over and under is considered by many to be the epitome of shotguns; and these handsome guns make a statement to the world that a shooter has arrived. High Grade Browning Citori 725 small gauge shotguns combine many of our most modern features with the style and grace for which over and unders are coveted. Each one of these fine guns receives 30 hours of hand engraving. They are limited in production, so order yours today.



A fitted John M. Browning Signature distressed leather case is included with the Citori 725 Grade VII Small Gauge.





A CITORI 725
GRADE VII, 20 GAUGE



B CITORI 725
GRADE VII, 28 GAUGE



C CITORI 725
GRADE VII, .410 BORE



Grade VII Engraving, Right



Grade VII Engraving, Left



Grade VII Engraving, Bottom

RECEIVER Steel • Low profile • Blued finish • Gold accented Grade VII deep-relief engraving **BARREL** Ventilated top and side rib • Floating rib **ACTION** Fire Lite mechanical trigger system • Hammer ejectors • Top-tang barrel selector/safety **STOCK** Oil finish Grade VI/VII walnut with close radius pistol grip and palm swell **FEATURES** Vector Pro lengthened forcing cones (20 gauge only) • Five black extended choke tubes included (Invector-DS with 20, Standard Invector with 28 and .410) • Ivory front and mid-bead sights • 1/2" recoil pad installed, 1" recoil pad included • John M. Browning Signature fitted case included **IDEAL USAGE** Hunting/Sporting Clays

NEW 2016	GAUGE/BORE	CODE NUMBER	SUGGESTED RETAIL	BARREL LENGTH Inches	CHOKES Included	CHAMBER Inches	AVERAGE WEIGHT lbs. / oz.	OVERALL LENGTH Inches	DROP AT COMB Inches	DROP AT HEEL Inches	LENGTH OF PULL Inches	RIB WIDTH Inches
CITORI 725 GRADE VII SMALL GAUGE												
A	• 20	0180016002	6,269.99	32	F,IM,M,IC,SK	3	7 / 4	49-3/4	1-5/8	2-1/2	14-1/4	5/16-7/16
	• 20	0180016003	6,269.99	30	F,IM,M,IC,SK	3	7 / 2	47-3/4	1-5/8	2-1/2	14-1/4	5/16-7/16
	• 20	0180016004	6,269.99	28	F,IM,M,IC,SK	3	7 / 0	45-3/4	1-5/8	2-1/2	14-1/4	5/16-7/16
B	• 28	018001811	6,269.99	32	F,IM,M,IC,SK	2-3/4	7 / 7	49-3/4	1-5/8	2-1/2	14-1/4	5/16-7/16
	• 28	018001812	6,269.99	30	F,IM,M,IC,SK	2-3/4	7 / 5	47-3/4	1-5/8	2-1/2	14-1/4	5/16-7/16
	• 28	018001813	6,269.99	28	F,IM,M,IC,SK	2-3/4	7 / 3	45-3/4	1-5/8	2-1/2	14-1/4	5/16-7/16
C	• .410	018001911	6,269.99	32	F,IM,M,IC,SK	3	7 / 8	49-3/4	1-5/8	2-1/2	14-1/4	5/16-7/16
	• .410	018001912	6,269.99	30	F,IM,M,IC,SK	3	7 / 6	47-3/4	1-5/8	2-1/2	14-1/4	5/16-7/16
	• .410	018001913	6,269.99	28	F,IM,M,IC,SK	3	7 / 4	45-3/4	1-5/8	2-1/2	14-1/4	5/16-7/16





ROBBIE PURSER

Robbie Purser is a longtime Browning Pro Staffer and has won skeet and sporting clays titles across the country — most with Browning Citori shotguns. Read more about Robbie on page 309.



PRO LEVEL PERFORMANCE.

Get pro level performance with a Citori 725 Pro. Pro models include features that allow you to perfectly dial-in the fit of the shotgun which, in turn, lets you crank up your performance on the range.

725
CITORI
PRO

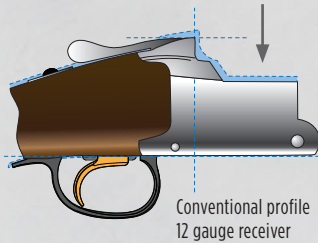
CITORI 725 PRO FEATURES AND BENEFITS

Conventional profile
12 gauge receiver

LOW PROFILE RECEIVER

- Improved recoil control and less muzzle jump are two of the big benefits of a low profile receiver. There is also the “one with the gun” feeling that makes the Citori 725 feel like an extension of your body.
- Places the front hand closer to the bore line for superior hand-eye coordination and pointability.

**ABS CASE INCLUDED**

- The sturdy, lockable ABS case is perfect for storing and transporting the Citori 725 Pro.

**TRIPLE TRIGGER SYSTEM**

- The Triple Trigger System fine tunes finger-to-trigger reach on target models.
- Includes three trigger shoes: Wide checked, narrow smooth and wide smooth canted.

**PALM SWELL**

- Aids in control.
- Optimizes finger-to-trigger placement.
- Provides a comfortable, secure grip.

**FLOATING RIB**

- The floating rib allows the rib and barrel to expand independently.
- Prevents changes to point of impact due to barrel heating.

**PRO FIT ADJUSTABLE COMB**

- The Browning Pro Fit Adjustable Comb makes it easy to find the perfect comb position.



- Pro Fit offers single bolt adjustment for both cast and drop. The revised design allows the stock to be professionally fit for shorter length of pull.
- Easy to read markings allow the shotgun to be dialed in and easily replicated should the comb be removed.

**PRO BALANCE SYSTEM**

- The Pro Balance System allows you to fine-tune the balance point for a perfect mount and swing.
- Adding weights to the stock helps balance the shotgun, aids follow-up shots and the additional mass reduces felt recoil.

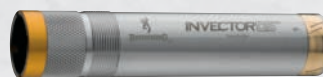

- Stock weights reduce muzzle jump for more accurate follow-up shots and allow a smoother follow through.
- Pro Balance weights are easy to install.

**INVICTOR-DS CHOKE TUBE SYSTEM**

- Citori 725 Pro models include five extended Invictor-DS tubes.
- Invictor-DS choke tubes combine muzzle-end threads and thin-wall construction for a longer, more gradually tapered choke tube that produces extremely consistent, dense shot patterns.
- From Cylinder to Extra Full, Invictor-DS shot patterns tighten consistently in reliable, evenly scaled steps.
- The more gradual taper of Invictor-DS choke tubes reduces shot deformation for fewer flyers and gaps in the pattern and allows higher shot velocities for hard hitting performance.
- The “DS” stands for double-seal. Our proprietary differential-banded brass seal compresses against the barrel wall to keep the choke tube threads clean and make installation and removal easier than any other muzzle thread system.

ALL BROWNING FIREARMS ARE SHIPPED WITH A FREE LOCKING DEVICE TO ASSIST IN THE SAFE STORAGE OF FIREARMS.

READY FOR COMPETITION.

Whether you travel across the country to enter shoots or find the challenge of mastering the sport to be your greatest competition, having a top-notch shotgun is essential. Now you need look no further than a Citori 725 Pro to put you on top.



A CITORI 725 PRO SPORTING WITH PRO FIT ADJUSTABLE COMB



Pro Sporting Engraving, Right



B CITORI 725 PRO TRAP WITH PRO FIT ADJUSTABLE COMB



Pro Trap Engraving, Right

A CITORI 725 PRO SPORTING WITH PRO FIT ADJUSTABLE COMB

RECEIVER Steel • Low-profile (12 gauge) • Silver nitride finish • Gold accented engraving **BARREL** Ventilated top and side ribs • Ported • Floating rib **ACTION** Fire Lite Mechanical trigger system • Hammer ejectors • Top-tang barrel selector/safety **STOCK** Gloss oil finish Grade III/IV walnut with close radius pistol grip and palm swell • Pro Fit Adjustable Comb • Inflex recoil pad **FEATURES** Vector Pro lengthened forcing cones • Five Invector-DS extended choke tubes • Pro Balance System • Triple Trigger System • HiViz® Pro-Comp sight and ivory mid-bead • Includes Elite ABS case **IDEAL USAGE** Sporting Clays/Skeet

B CITORI 725 PRO TRAP WITH PRO FIT ADJUSTABLE COMB

RECEIVER Steel • Low-profile • Silver nitride finish • Gold accented engraving **BARREL** Ventilated top and side ribs • Ported • Floating rib **ACTION** Fire Lite Mechanical trigger system • Hammer ejectors • Top-tang barrel selector/safety **STOCK** Gloss finish Grade III/IV walnut with close radius pistol grip and palm swell • Pro Fit Adjustable Comb • Semi-beavertail forearm with finger grooves **FEATURES** Vector Pro lengthened forcing cones • Five Invector-DS extended choke tubes • Pro Balance System • Triple Trigger System • HiViz® Pro-Comp sight and ivory mid-bead • Includes Elite ABS case **IDEAL USAGE** Trap

NEW 2016	GAUGE	CODE NUMBER	SUGGESTED RETAIL	BARREL LENGTH Inches	CHOKES Included	CHAMBER Inches	AVERAGE WEIGHT lbs. / Oz.	OVERALL LENGTH Inches	DROP AT COMB Inches	DROP AT HEEL Inches	LENGTH OF PULL Inches	RIB WIDTH Inches
CITORI 725 PRO SPORTING WITH PRO FIT ADJUSTABLE COMB												
A	12	0180024009	3,999.99	32	F,IM,M,IC,SK	2-3/4	7 / 13	50	1-3/4 adj.	2-1/2 adj.	14-3/4	5/16-7/16
	12	0180024010	3,999.99	30	F,IM,M,IC,SK	2-3/4	7 / 11	48	1-3/4 adj.	2-1/2 adj.	14-3/4	5/16-7/16
	20	0180027009	3,999.99	32	F,IM,M,IC,SK	2-3/4	7 / 7	50	1-3/4 adj.	2-1/2 adj.	14-3/4	5/16-7/16
	20	0180027010	3,999.99	30	F,IM,M,IC,SK	2-3/4	7 / 5	48	1-3/4 adj.	2-1/2 adj.	14-3/4	5/16-7/16
CITORI 725 PRO TRAP WITH PRO FIT ADJUSTABLE COMB												
B	12	0180033009	3,999.99	32	F,LF,IM,IM,M	2-3/4	8 / 11	50	1-11/16 adj.	1-15/16 adj.	14-3/8	1/4-3/8
	12	0180033010	3,999.99	30	F,LF,IM,IM,M	2-3/4	8 / 8	48	1-11/16 adj.	1-15/16 adj.	14-3/8	1/4-3/8





FOSTER
AND **MATT**
BARTHLOW

Browning Pro Staff shooters, brothers Foster and Matt Bartholow, put their Browning Citori shotguns to good use on the ATA trapshooting circuit. Read more about Foster and Matt on page 311.

CITORI 725 — IT'S TOUGH TO KEEP A LOW PROFILE.

It's hard to avoid getting noticed with a gun that looks and shoots as good as the Citori 725. Citori 725 models utilize a low-profile receiver design that retains the features that make the Citori so tough, and adds the benefits of improved recoil control, balance and swing.

725
CITORI**CITORI 725 FEATURES AND BENEFITS****TRIPLE TRIGGER SYSTEM**

- The Triple Trigger System fine tunes finger-to-trigger reach on target models.
- Includes three trigger shoes: Wide checkered, narrow smooth and wide smooth canted.

**HIGH RIB**

- Offers increased visibility — the barrels don't cover up the target.
- Improved cooling helps prevent heat waves from distorting visibility.

**FLOATING RIB**

- The floating rib allows the rib and barrel to expand independently to eliminate stress.
- Prevents changes to point of impact due to barrel heating and the rib staying cool.

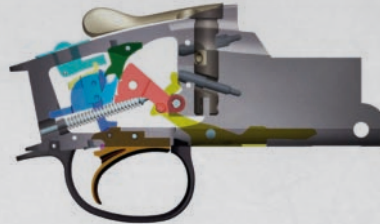
**FIRE
LITE**
MECHANICAL
TRIGGER**FIRE LITE
MECHANICAL TRIGGER**

- Exclusive mechanical trigger design.
- Unlike an inertia trigger, Fire Lite does not rely on recoil to set the next shot; instead, it offers immediate second shot capability.
- Features less take-up, a crisp break and shorter overtravel.
- The Fire Lite Mechanical Trigger is light, crisp and has minimal overtravel.

**TAPERED LOCKING BOLT**

- Unlike other low-profile over and unders, the Citori 725 features a transverse-mounted, full-width tapered locking bolt and full-width hinge pin just like other Citori models for maximum strength and longevity.
- The locking bolt engages a full-width tapered recess in the monoblock. Tapering the bolt and recess allows the bolt to seat deeper over time, accommodating for wear.

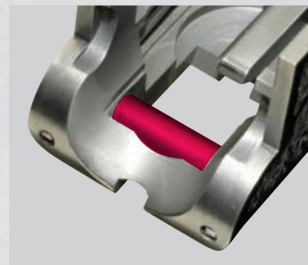
**FULL-WIDTH HINGE PIN**

The Citori 725's full-width hinge pin provides maximum strength and long-lasting endurance.

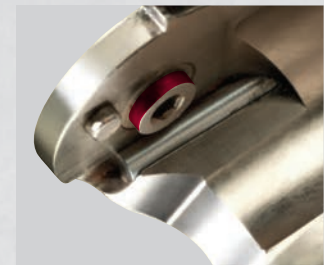
**COMPETING TRUNNION
DESIGN**

The competitors' trunnions provide only a fraction of the bearing surface that the Citori 725's full-width hinge pin provides.

**ERGO
BALANCED****ERGO BALANCED**

- Incredibly balanced in the hands from pad to muzzle.
- Facilitates a light feel and fast swing.
- Promotes follow through.

**BECOME
ONE
WITH THE
GUN**

ALL BROWNING FIREARMS ARE SHIPPED WITH A FREE LOCKING DEVICE TO ASSIST IN THE SAFE STORAGE OF FIREARMS.

PLAY THE GAME.

Shooting sporting clays is exciting and challenging. Achieving top scores requires practice and a Browning Citori 725 Sporting. 725 Sporting guns are loaded with features that help you shoot your best.



A CITORI 725 SPORTING



725 Sporting Engraving, Right



725 Sporting Engraving, Bottom



B CITORI 725 STANDARD RIB SPORTING WITH ADJUSTABLE COMB



C CITORI 725 HIGH RIB SPORTING WITH ADJUSTABLE COMB

RECEIVER Steel • Low-profile (12 gauge) • Silver nitride finish • Gold accented engraving **BARREL** Ventilated top and side ribs • Ported • Floating rib **ACTION** Fire Lite Mechanical trigger system • Hammer ejectors • Top-tang barrel selector/safety **STOCK** Gloss oil finish Grade III/IV walnut with close radius pistol grip and palm swell • Available with adjustable comb • Inflex recoil pad **FEATURES** Vector Pro lengthened forcing cones • Five extended choke tubes included (Invector-DS with 12 and 20, Standard Invector with 28 and .410) • Triple Trigger System • HiViz® Pro-Comb sight and ivory mid-bead **IDEAL USAGE** Sporting Clays/Skeet

	NEW 2016 GAUGE/BORE	CODE NUMBER	SUGGESTED RETAIL	BARREL LENGTH Inches	CHOKES Included	CHAMBER Inches	AVERAGE WEIGHT Lbs. / Oz.	OVERALL LENGTH Inches	DROP AT COMB Inches	DROP AT HEEL Inches	LENGTH OF PULL Inches	RIB WIDTH Inches
CITORI 725 SPORTING												
A	12	0135313009	3,139.99	32	F,IM,M,IC,SK	3	7 / 10	50	1-9/16	2-3/8	14-3/4	5/16-7/16
	12	0135313010	3,139.99	30	F,IM,M,IC,SK	3	7 / 8	48	1-9/16	2-3/8	14-3/4	5/16-7/16
	20	0135316009	3,139.99	32	F,IM,M,IC,SK	3	7 / 3	50	1-9/16	2-3/16	14-3/4	5/16-7/16
	20	0135316010	3,139.99	30	F,IM,M,IC,SK	3	7 / 1	48	1-9/16	2-3/16	14-3/4	5/16-7/16
	• 28	013531811	3,199.99	32	F,IM,M,IC,SK	2-3/4	7 / 6	50	1-9/16	2-3/8	14-3/4	5/16-7/16
	• 28	013531812	3,199.99	30	F,IM,M,IC,SK	2-3/4	7 / 4	48	1-9/16	2-3/8	14-3/4	5/16-7/16
	• .410	013531911	3,199.99	32	F,IM,M,IC,SK	3	7 / 7	50	1-9/16	2-3/8	14-3/4	5/16-7/16
	• .410	013531912	3,199.99	30	F,IM,M,IC,SK	3	7 / 5	48	1-9/16	2-3/8	14-3/4	5/16-7/16
CITORI 725 STANDARD RIB SPORTING WITH ADJUSTABLE COMB												
B	12	0135533009	3,529.99	32	F,IM,M,IC,SK	3	7 / 13	50	1-3/4 adj.	2-1/2 adj.	14-3/4	5/16-7/16
	12	0135533010	3,529.99	30	F,IM,M,IC,SK	3	7 / 11	48	1-3/4 adj.	2-1/2 adj.	14-3/4	5/16-7/16
CITORI 725 HIGH RIB SPORTING WITH ADJUSTABLE COMB												
C	12	0136243009	3,599.99	32	F,IM,M,IC,SK	3	7 / 10	50	1-9/16 adj.	2-3/8 adj.	14-3/4	5/16-7/16
	12	0136243010	3,599.99	30	F,IM,M,IC,SK	3	7 / 8	48	1-9/16 adj.	2-3/8 adj.	14-3/4	5/16-7/16



A CITORI 725 TRAP



B CITORI 725 TRAP WITH ADJUSTABLE COMB



C CITORI 725 SKEET



725 Skeet Engraving, Right



725 Skeet Engraving, Bottom



D CITORI 725 SKEET WITH ADJUSTABLE COMB

A CITORI 725 TRAP B CITORI 725 TRAP WITH ADJUSTABLE COMB

RECEIVER Steel • Low-profile • Silver nitride finish • Gold accented engraving **BARREL** Ventilated top and side ribs • Ported • Floating top rib **ACTION** Fire Lite Mechanical trigger system • Hammer ejectors • Top-tang barrel selector/safety **STOCK** Gloss finish Grade III/IV walnut with close radius pistol grip and palm swell • Monte Carlo cheekpiece or adjustable comb • Ventilated trap recoil pad • Semi-beavertail forearm with finger grooves **FEATURES** Vector Pro lengthened forcing cones • Three Invector-DS choke tubes • Triple Trigger System • HiViz® Pro-Comp sight and ivory mid-bead **IDEAL USAGE** Trap

C CITORI 725 SKEET D CITORI 725 SKEET WITH ADJUSTABLE COMB

RECEIVER Steel • Low-profile • Silver nitride finish • Gold accented engraving **BARREL** Ventilated top and side ribs • Ported • Floating top rib **ACTION** Fire Lite Mechanical trigger system • Hammer ejectors • Top-tang barrel selector/safety **STOCK** Gloss finish Grade III/IV walnut with close radius pistol grip and palm swell • Available with adjustable comb • Semi-beavertail forearm with finger grooves • Inflex recoil pad **FEATURES** Vector Pro lengthened forcing cones • Three Invector-DS choke tubes • Triple Trigger System • HiViz® Pro-Comp sight and ivory mid-bead **IDEAL USAGE** Skeet/Sporting Clays

NEW 2016 GAUGE	CODE NUMBER	SUGGESTED RETAIL	BARREL LENGTH Inches	CHOKES Included	CHAMBER Inches	AVERAGE WEIGHT Lbs. / Oz.	OVERALL LENGTH Inches	DROP AT COMB Inches	DROP AT HEEL Inches	LENGTH OF PULL Inches	RIB WIDTH Inches
CITORI 725 TRAP											
A	12 0135793009	3,339.99	32	F,IM,M	2-3/4	8 / 10	50	1-9/16	1-15/16	14-3/8	1/4-3/8
	12 0135793010	3,339.99	30	F,IM,M	2-3/4	8 / 7	48	1-9/16	1-15/16	14-3/8	1/4-3/8
CITORI 725 TRAP WITH ADJUSTABLE COMB											
B	12 0135803009	3,739.99	32	F,IM,M	2-3/4	8 / 11	50	1-11/16 adj.	1-15/16 adj.	14-3/8	1/4-3/8
	12 0135803010	3,739.99	30	F,IM,M	2-3/4	8 / 8	48	1-11/16 adj.	1-15/16 adj.	14-3/8	1/4-3/8
CITORI 725 SKEET											
C	12 0136163010	3,139.99	30	SK,SK,IC	3	7 / 11	48	1-3/4	1-3/4	14-3/8	3/8
	12 0136163011	3,139.99	28	SK,SK,IC	3	7 / 9	46	1-3/4	1-3/4	14-3/8	3/8
CITORI 725 SKEET WITH ADJUSTABLE COMB											
D	12 0136173010	3,529.99	30	SK,SK,IC	3	8 / 0	48	1-7/8 adj.	1-7/8 adj.	14-3/8	3/8
	12 0136173011	3,529.99	28	SK,SK,IC	3	7 / 14	46	1-7/8 adj.	1-7/8 adj.	14-3/8	3/8



GO AFIELD WITH A CITORI 725.

Fast-moving pheasants exploding from the corn and doves passing across the sky require a gun that points and swings with natural grace and speed. A Browning Citori 725 Field gun is equal to the task and ready to shoulder in an instant.



E CITORI 725 FIELD



Field 20 Gauge Engraving, Right



Field 20 Gauge Engraving, Left



F CITORI 725 FEATHER



Feather 12 Gauge Engraving, Right



Feather 12 Gauge Engraving, Left

E CITORI 725 FIELD

RECEIVER Steel • Low-profile (12 gauge) • Silver nitride finish • Accented, high-relief engraving **BARREL** Ventilated top rib **ACTION** Fire Lite Mechanical trigger system • Hammer ejectors • Top-tang barrel selector/safety **STOCK** Gloss oil finish Grade II/III walnut with close radius pistol grip • Inflex recoil pad **FEATURES** Vector Pro lengthened forcing cones • Three choke tubes included (Invector-DS with 12 and 20, Standard Invector with 28 and .410) • Ivory front and mid-bead sights **IDEAL USAGE** Hunting/Sporting Clays

F CITORI 725 FEATHER

RECEIVER Lightweight alloy with steel breech face and hinge pin • Low-profile (12 gauge) • Silver nitride finish • Accented, high-relief engraving **BARREL** Ventilated top rib **ACTION** Fire Lite Mechanical trigger system • Hammer ejectors • Top-tang barrel selector/safety **STOCK** Gloss oil finish Grade II/III walnut with close radius pistol grip • Inflex recoil pad **FEATURES** Vector Pro lengthened forcing cones • Three Invector-DS choke tubes • Ivory front and mid-bead sights **IDEAL USAGE** Hunting/Sporting Clays

	NEW 2016 GAUGE/BORE	CODE NUMBER	SUGGESTED RETAIL	BARREL LENGTH Inches	CHOICES Included	CHAMBER Inches	AVERAGE WEIGHT Lbs./Oz.	OVERALL LENGTH Inches	DROP AT COMB Inches	DROP AT HEEL Inches	LENGTH OF PULL Inches	RIB WIDTH Inches
CITORI 725 FIELD												
	12	0135303004	2,469.99	28	F,M,IC	3	7 / 6	45-3/4	1-5/8	2-1/2	14-1/4	1/4
	12	0135303005	2,469.99	26	F,M,IC	3	7 / 4	43-3/4	1-5/8	2-1/2	14-1/4	1/4
E	20	0135306004	2,469.99	28	F,M,IC	3	6 / 9	45-3/4	1-1/2	2-3/8	14-1/4	1/4
	20	0135306005	2,469.99	26	F,M,IC	3	6 / 7	43-3/4	1-1/2	2-3/8	14-1/4	1/4
	• 28	013530813	2,539.99	28	F,M,IC	2-3/4	7 / 2	45-3/4	1-1/2	2-3/8	14-1/4	1/4
	• 28	013530814	2,539.99	26	F,M,IC	2-3/4	7 / 0	43-3/4	1-1/2	2-3/8	14-1/4	1/4
	• .410	013530913	2,539.99	28	F,M,IC	3	7 / 3	45-3/4	1-1/2	2-3/8	14-1/4	1/4
	• .410	013530914	2,539.99	26	F,M,IC	3	7 / 1	43-3/4	1-1/2	2-3/8	14-1/4	1/4
CITORI 725 FEATHER												
F	12	0135663004	2,549.99	28	F,M,IC	3	6 / 9	45-3/4	1-5/8	2-1/2	14-1/4	1/4
	12	0135663005	2,549.99	26	F,M,IC	3	6 / 7	43-3/4	1-5/8	2-1/2	14-1/4	1/4
	20	0135666004	2,549.99	28	F,M,IC	3	5 / 14	45-3/4	1-1/2	2-3/8	14-1/4	1/4
	20	0135666005	2,549.99	26	F,M,IC	3	5 / 12	43-3/4	1-1/2	2-3/8	14-1/4	1/4



LEGENDARY CRAFTSMANSHIP.

Each and every Browning Citori is fit and assembled by hand to achieve a level of perfection and durability that rivals guns costing hundreds or even thousands of dollars more. The extra attention to detail assures smooth operation and flawless looks, adding longevity and integrity so that your Citori will be good to go for the next generation.

Citori

CITORI FEATURES AND BENEFITS



TRIPLE TRIGGER SYSTEM

Citori target shotguns come equipped with the Triple Trigger System, which fine tunes finger-to-trigger length of pull. Choose a wide checkered, narrow smooth or wide smooth canted trigger shoe.



LOCKING BOLT AND HINGE PIN

The Citori features a heavy-duty, transverse-mounted, full-width tapered locking bolt that engages a full-width tapered recess in the rear barrel lugs. Tapering the bolt and recess allows the bolt to seat deeper, accommodating for wear. The hinge pin extends across the width of the receiver for maximum strength. Engineering like this ensures the Citori wears in, not out.

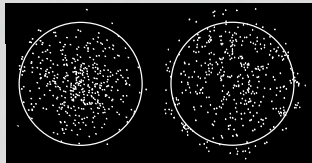

Browning pattern with Back-Bored Technology

The competitors' pattern without Back-Bored Technology

CHROME CHAMBERS

For increased durability and corrosion resistance, all Citori shotguns have hard chrome-plated chambers to resist the toll that thousands of shells can take on lesser quality guns.



STEEL SHOT PERFORMANCE

The strength of Browning barrels is legendary, and built to handle the punishment of steel shot. Unlike some manufacturers' barrels that show pitting after shooting steel, Browning pioneered construction that maximizes steel shot performance and barrel durability. Browning barrels meet the strictest material and construction quality standards. The barrel blanks are made from rolled and tempered steel bars and are stress relieved to offer exceptional mechanical properties. The barrel blanks are then precision drilled, reamed and honed to exacting specifications. With proper care, Browning Citori barrels will last a lifetime.

HAMMERS AND HAMMER EJECTORS

For positive primer ignition, Citori hammers are driven by powerful coil mainsprings. The convenient barrel selector allows you to choose which barrel fires on the first pull of the single trigger, and the second pull fires the remaining barrel. Ejectors are fired by a sharp hammer blow for more positive ejection than the push imparted by competitors' ejectors. The automatic ejectors eject fired hulls when the breech is opened and elevate unfired shells for easy removal.

VECTORPRO™

VECTOR PRO LENGTHENED FORCING CONES ON 12 AND 20 GAUGE CITORI SHOTGUNS

Browning was the first manufacturer to recognize the performance advantages of a back-bored barrel and to make it a standard feature on shotguns. Longer, tapered Vector Pro forcing cone dimensions minimize shot deformation and maximize pattern uniformity, consistency and density. Back-boring increases bore diameter specifications and decreases friction between the shot cup and the bore to maximize shot pellet velocity and to reduce felt recoil. Reducing constriction from the forcing cone on the shot column results in fewer deformed pellets for more uniform patterns, and keeps more pellets in the central part of the pattern where they're needed to bag more upland birds, waterfowl and clay targets. Browning back-bore specifications represent the ideal bore dimensions. A larger bore diameter can let gases slip by the shot cup, resulting in both reduced pellet velocity and blown patterns. A smaller bore diameter means the forcing cone can deform pellets, leading to flyers and poor ballistic performance.

INVECTOR CHOKE TUBE SYSTEMS

The proven Standard Invector (28 gauge, .410 bore) or Invector-Plus (12, 20 gauge) interchangeable choke tube systems are featured on every Citori shotgun and provide consistent, dense shot patterns in the constriction needed for the specific shooting situation. The longer choke taper inside an Invector-Plus choke tube works with back-bored barrels and Vector Pro lengthened forcing cones to produce dense patterns with uniform densities and fewer flyers. The superior designs of the Invector systems are far more durable than the choke systems found in competitors' guns, especially when shooting steel shot loads. The Invector systems eliminate gases slipping between the choke tube and barrel that could damage both the choke tube and the barrel. See pages 175 to 179 for a complete listing of choke tubes and wrenches.

ALL BROWNING FIREARMS ARE SHIPPED WITH A FREE LOCKING DEVICE TO ASSIST IN THE SAFE STORAGE OF FIREARMS.



A CITORI LIGHTNING



Lightning Engraving, Right



B CITORI WHITE LIGHTNING



White Lightning Engraving, Right



C CITORI MICRO MIDAS

A CITORI LIGHTNING B CITORI WHITE LIGHTNING

RECEIVER Steel • High-relief engraving • Blued finish on Lightning • Silver Nitride finish on White Lightning **BARREL** Ventilated rib **ACTION** Single selective trigger • Hammer ejectors • Top-tang barrel selector/safety **STOCK** Lightning-style stock and forearm • Lightning: Gloss finish, White Lightning: Gloss oil • Grade I/II walnut on Lightning • Grade II/III on White Lightning **FEATURES** Vector Pro lengthened forcing cones on 12 and 20 • Three Invector-Plus choke tubes with 12 and 20 • Three Standard Invector choke tubes with 28 and .410 • Recoil pad on 12 gauge model • Silver front bead sight **IDEAL USAGE** Hunting/Sporting Clays

C CITORI MICRO MIDAS

RECEIVER Steel • Blued finish **BARREL** Ventilated rib **ACTION** Single selective trigger • Hammer ejectors • Top-tang barrel selector/safety **STOCK** Satin finish walnut • Compact stock with 13" length of pull **FEATURES** Vector Pro lengthened forcing cones • Three Invector-Plus choke tubes • Ventilated recoil pad • Silver front bead sight **IDEAL USAGE** Hunting/Sporting Clays **ELIGIBLE FOR THE GROWTH INSURANCE PROGRAM** See page 4 for details

	NEW 2016	GAUGE/BORE	CODE NUMBER	SUGGESTED RETAIL	BARREL LENGTH Inches	CHOKES Included	CHAMBER Inches	AVERAGE WEIGHT Lbs./Oz.	OVERALL LENGTH Inches	DROP AT COMB Inches	DROP AT HEEL Inches	LENGTH OF PULL Inches	RIB WIDTH Inches
CITORI LIGHTNING													
		12	013461304	1,989.99	28	F,M,IC	3	8 / 2	45	1-5/8	2-1/2	14-1/4	5/16
		12	013461305	1,989.99	26	F,M,IC	3	8 / 0	43	1-5/8	2-1/2	14-1/4	5/16
A		20	013461604	1,989.99	28	F,M,IC	3	6 / 9	45	1-1/2	2-3/8	14-1/4	1/4
		20	013461605	1,989.99	26	F,M,IC	3	6 / 7	43	1-1/2	2-3/8	14-1/4	1/4
		28	013461813	2,069.99	28	F,M,IC	2-3/4	6 / 12	45	1-1/2	2-3/8	14-1/4	1/4
		28	013461814	2,069.99	26	F,M,IC	2-3/4	6 / 10	43	1-1/2	2-3/8	14-1/4	1/4
		.410	013461913	2,069.99	28	F,M,IC	3	6 / 10	45	1-1/2	2-3/8	14-1/4	1/4
		.410	013461914	2,069.99	26	F,M,IC	3	6 / 8	43	1-1/2	2-3/8	14-1/4	1/4
CITORI WHITE LIGHTNING													
		12	013462304	2,069.99	28	F,M,IC	3	8 / 2	45	1-5/8	2-1/2	14-1/4	5/16
B		12	013462305	2,069.99	26	F,M,IC	3	8 / 0	43	1-5/8	2-1/2	14-1/4	5/16
		20	013462604	2,069.99	28	F,M,IC	3	6 / 9	45	1-1/2	2-3/8	14-1/4	1/4
		20	013462605	2,069.99	26	F,M,IC	3	6 / 7	43	1-1/2	2-3/8	14-1/4	1/4
		28	013462813	2,139.99	28	F,M,IC	2-3/4	6 / 12	45	1-1/2	2-3/8	14-1/4	1/4
		28	013462814	2,139.99	26	F,M,IC	2-3/4	6 / 10	43	1-1/2	2-3/8	14-1/4	1/4
		.410	013462913	2,139.99	28	F,M,IC	3	6 / 10	45	1-1/2	2-3/8	14-1/4	1/4
		.410	013462914	2,139.99	26	F,M,IC	3	6 / 8	43	1-1/2	2-3/8	14-1/4	1/4
CITORI MICRO MIDAS													
		12	013497305	1,649.99	26	F,M,IC	3	7 / 12	41-3/4	1-5/8	2-1/2	13	5/16
C		12	013497306	1,649.99	24	F,M,IC	3	7 / 10	39-3/4	1-5/8	2-1/2	13	5/16
		20	013497605	1,649.99	26	F,M,IC	3	6 / 1	41-3/4	1-1/2	2-3/8	13	1/4
		20	013497606	1,649.99	24	F,M,IC	3	5 / 15	39-3/4	1-1/2	2-3/8	13	1/4





A CITORI FEATHER LIGHTNING

Feather Lightning Engraving, Right



B CITORI SUPERLIGHT FEATHER

Superlight Feather Engraving, Bottom



C CITORI LIGHTNING FEATHER COMBO

Traditional fitted case included with Lightning Feather Combo.

A CITORI FEATHER LIGHTNING

RECEIVER Lightweight alloy with steel breech face and hinge pin • High-relief engraving **BARREL** Ventilated rib **ACTION** Single selective trigger • Hammer ejectors • Top-tang barrel selector/safety **STOCK** Gloss oil finish Grade II/III walnut • Lightning-style stock and forearm **FEATURES** Vector Pro lengthened forcing cones • Three Invector-Plus choke tubes • Recoil pad on 12 gauge model • Silver front bead sight **IDEAL USAGE** Hunting/Sporting Clays

B CITORI SUPERLIGHT FEATHER

RECEIVER Lightweight alloy with steel breech face and hinge pin • High-relief engraving **BARREL** Ventilated rib **ACTION** Single selective trigger • Hammer ejectors • Top-tang barrel selector/safety **STOCK** Gloss finish walnut • English-style straight grip stock • Schnabel forearm **FEATURES** Vector Pro lengthened forcing cones • Three Invector-Plus choke tubes • Silver front bead sight **IDEAL USAGE** Hunting/Sporting Clays

C CITORI LIGHTNING FEATHER COMBO

RECEIVER Lightweight alloy with steel breech face and hinge pin • High-relief engraving **BARREL** Combo includes 3" chambered 20 gauge and 2-3/4" chambered 28 gauge barrels in 27" length • Ventilated rib **ACTION** Single selective trigger • Hammer ejectors • Top-tang barrel selector/safety **STOCK** Gloss finish walnut • Lightning-style stock and forearm **FEATURES** Vector Pro lengthened forcing cones on 20 gauge barrels • Three Invector-Plus 20 gauge choke tubes • Three Standard Invector 28 gauge choke tubes • Silver front bead sight • Traditional fitted case included **IDEAL USAGE** Hunting/Sporting Clays

	NEW 2016	GAUGE	CODE NUMBER	SUGGESTED RETAIL	BARREL LENGTH Inches	CHOKES Included	CHAMBER Inches	AVERAGE WEIGHT Lbs. / Oz.	OVERALL LENGTH Inches	DROP AT COMB Inches	DROP AT HEEL Inches	LENGTH OF PULL Inches	RIB WIDTH Inches
CITORI FEATHER LIGHTNING													
		12	013554304	2,179.99	28	F,M,IC	3	7 / 2	45	1-5/8	2-1/2	14-1/4	1/4
		12	013554305	2,179.99	26	F,M,IC	3	7 / 0	43	1-5/8	2-1/2	14-1/4	1/4
A		20	013554604	2,179.99	28	F,M,IC	3	6 / 0	45	1-1/2	2-3/8	14-1/4	1/4
		20	013554605	2,179.99	26	F,M,IC	3	5 / 14	43	1-1/2	2-3/8	14-1/4	1/4
CITORI SUPERLIGHT FEATHER													
		12	013055405	2,389.99	26	F,M,IC	2-3/4	6 / 4	43	1-5/8	2-1/2	14-1/4	1/4
B		20	013055705	2,389.99	26	F,M,IC	2-3/4	5 / 11	43	1-1/2	2-3/8	14-1/4	7/32
CITORI LIGHTNING FEATHER COMBO													
C		20/28	013064735	3,579.99	27	F,M,IC	3 & 2-3/4	6 / 3	44	1-1/2	2-3/8	14-1/4	1/4



LASTING PERFORMANCE AND VALUE.

Browning Citori XT Trap guns have a well-earned reputation for lasting reliability; which is why people say that a Citori wears in, not out. The XT Trap is built with a full-width steel hinge pin (rather than a pair of trunnions) and a tapered locking lug that is designed to seat deeper with wear and keep the action locking up tight.



D CITORI XT TRAP, GRADE I



E CITORI XT TRAP, GRADE I WITH ADJUSTABLE COMB



XT Trap Engraving, Right



XT Trap Engraving, Bottom

D CITORI XT TRAP, GRADE I

RECEIVER Steel • Blued finish • Gold accented, high-relief engraving **BARREL** Ventilated top and side ribs • Tapered, floating high-post top rib • Ported **ACTION** Single selective trigger • Hammer ejectors • Top-tang barrel selector/safety **STOCK** Gloss finish Grade II/III walnut with right-hand palm swell • Ventilated trap recoil pad • Semi-beavertail forearm with finger grooves **FEATURES** Vector Pro lengthened forcing cones • Three Invector-Plus choke tubes • Triple Trigger System • HiViz® Pro-Comp sight • Mid-bead sight **IDEAL USAGE** Trap

E CITORI XT TRAP, GRADE I WITH ADJUSTABLE COMB

RECEIVER Steel • Blued finish • Gold accented, high-relief engraving **BARREL** Ventilated top and side ribs • Tapered, floating high-post top rib • Ported **ACTION** Single selective trigger • Hammer ejectors • Top-tang barrel selector/safety **STOCK** Gloss finish Grade II/III walnut with right-hand palm swell • Adjustable comb • Ventilated trap recoil pad • Semi-beavertail forearm with finger grooves **FEATURES** Vector Pro lengthened forcing cones • Three Invector-Plus choke tubes • Triple Trigger System • HiViz® Pro-Comp sight • Mid-bead sight **IDEAL USAGE** Trap

	NEW 2016 GAUGE	CODE NUMBER	SUGGESTED RETAIL	BARREL LENGTH Inches	CHOKES Included	CHAMBER Inches	AVERAGE WEIGHT Lbs. / Oz.	OVERALL LENGTH Inches	DROP AT COMB Inches	DROP AT HEEL Inches	LENGTH OF PULL Inches	RIB WIDTH Inches
CITORI XT TRAP, GRADE I												
	12	013620427	2,649.99	32	F,F,IM	2-3/4	8 / 8	49	1-9/16	2	14-3/8	1/4-3/8
D	12	013620426	2,649.99	30	F,F,IM	2-3/4	8 / 6	47	1-9/16	2	14-3/8	1/4-3/8
CITORI XT TRAP, GRADE I WITH ADJUSTABLE COMB												
	12	013621427	2,999.99	32	F,F,IM	2-3/4	8 / 13	49	1-11/16 adj.	1-15/16 adj.	14-3/8	1/4-3/8
E	12	013621426	2,999.99	30	F,F,IM	2-3/4	8 / 11	47	1-11/16 adj.	1-15/16 adj.	14-3/8	1/4-3/8



CYNERGY®

CYNERGY FEATURES AND BENEFITS

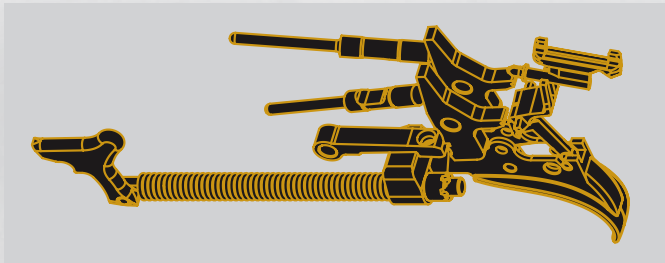
**REVERSE STRIKER MECHANICAL TRIGGER**

- The Reverse Striker is a striker-based, mechanical trigger system that does not use the inertia from recoil to set the hammers.
- Reverse Striker offers the benefits of a crisp feel, reduced locktime and less overtravel than other over and under shotguns.
- Because inertia is not needed for the hammers to set, the design eliminates the possibility of the second barrel not firing.
- Cynergy target models are equipped with the Triple Trigger System, allowing finger to trigger length adjustment and the ability to switch between styles of trigger shoes: Wide checkered, narrow smooth or wide smooth canted.

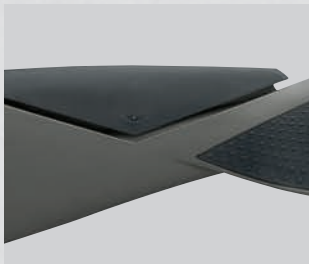
**ADJUSTABLE COMB**

- Composite models include an adjustable comb system that allows the fit of the gun to be customized.
- Drop at comb adjustments are made in 1/8" increments.
- For cast on/cast off customizing, we offer accessory combs that are shown below.

**SUPERIOR GRIPPING SURFACES**

- Composite Cynergy models feature molded-in rubberized gripping surfaces for a secure hold in every situation.

**MONOLOCK HINGE**

- The strong MonoLock Hinge design is the engineering behind the Cynergy's low profile receiver.
- Integrates the monobloc and the hinge for up to 300% more surface area to pivot on than traditional trunnion-style hinges.
- Rectangular locking pins provide extra strength and feature a "Wear-In Relief" that keeps the action tight.

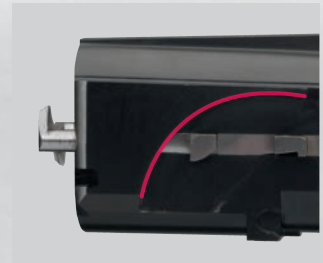
**CHROME CHAMBERS**

- Cynergy shotguns feature hard chrome-plated chambers.
- Increased durability and corrosion resistance.

IMPACT EJECTORS

- Impact Ejectors are aided by the punch of a secondary striker spring for positive, reliable ejection of fired hulls from the chambers.
- Unfired shells are elevated for easy removal.

CYNERGY ACCESSORIES

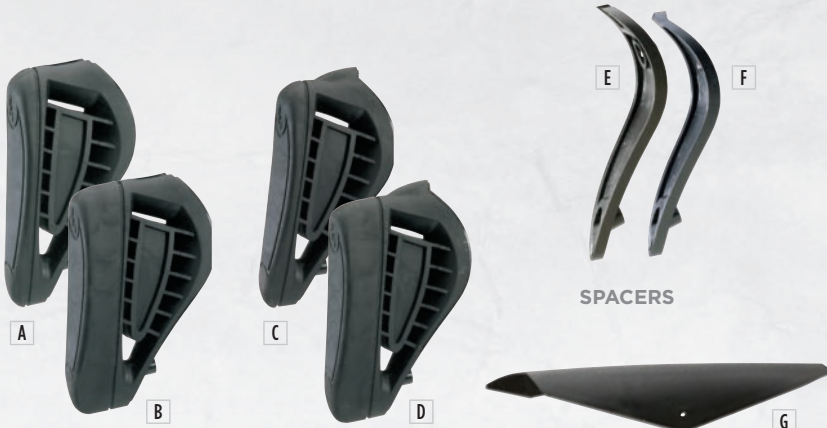
RECOIL PADS FOR
COMPOSITE GUNSRECOIL PADS FOR
WOOD GUNSCOMPOSITE MODEL
ADJUSTABLE COMB

ALL BROWNING FIREARMS ARE SHIPPED WITH A FREE LOCKING DEVICE TO ASSIST IN THE SAFE STORAGE OF FIREARMS.

NEW 2016	DESCRIPTION	CODE NUMBER	SUGGESTED RETAIL
CYNERGY ACCESSORIES			
A	Short Composite Recoil Pad	11400	58.00
	Medium Composite Recoil Pad	11401	58.00
B	Long Composite Recoil Pad	11402	58.00
C	Short Wood Recoil Pad	11410	58.00
	Medium Wood Recoil Pad	11411	58.00
D	Long Wood Recoil Pad	11412	58.00
E	1/4" Composite Stock Spacer	11430	12.00
F	1/4" Wood Stock Spacer	11431	12.00
G	Cast-on Adj. Comb, Composite	11420	38.00
	Cast-off Adj. Comb, Composite	11421	38.00

Length of pull is adjustable from 13-1/4" - 15" with the recoil pads and stock spacers above. See page 4 for details on Inflex pads. All new guns ship with medium pads.

DIFFERENT IS GOOD.

Though the Browning Cynergy is the lowest profile over and under on the market, it is also one of the strongest. The MonoLock Hinge design shrinks the receiver to reduce weight without sacrificing strength, and helps control recoil to make the Cynergy easier on the shoulder.



H CYNERGY FIELD



Field 12 Gauge Engraving, Right



Field 12 Gauge Engraving, Left



Field 20, 28 Gauge and .410 Bore Engraving, Right



Field 20, 28 Gauge and .410 Bore Engraving, Left



I CYNERGY MICRO MIDAS



Micro Midas Engraving, Right



Micro Midas Engraving, Left

H CYNERGY FIELD

RECEIVER Steel • Silver nitride finish • Ultra-low profile • Engraved receiver **BARREL** Lightweight profile • Ventilated top and side ribs • Matte blued finish **ACTION** Reverse Striker ignition system • Impact Ejectors • Top-tang barrel selector/safety **STOCK** Satin varnish finish • Grade 1/II walnut • Inflex recoil pad **FEATURES** Vector Pro lengthened forcing cones on 12 and 20 • Three Invector-Plus choke tubes with 12 and 20 • Three Standard Invector choke tubes with 28 and .410 • 1/4" stock spacer • Ivory front bead sight **IDEAL USAGE** Hunting/Sporting Clays

I CYNERGY MICRO MIDAS

RECEIVER Steel • Silver nitride finish • Ultra-low profile • MonoLock Hinge • Engraved receiver **BARREL** Lightweight profile • Ventilated top and side ribs • Matte blued finish **ACTION** Reverse Striker ignition system • Impact Ejectors • Top-tang barrel selector/safety **STOCK** Satin varnish finish • Grade 1/II walnut • Inflex recoil pad • Compact 13" length of pull **FEATURES** Vector Pro lengthened forcing cones • Three Invector-Plus choke tubes • Three 1/4" stock spacers • Ivory front bead sight **IDEAL USAGE** Hunting/Sporting Clays **ELIGIBLE FOR THE GROWTH INSURANCE PROGRAM** See page 4 for details

	NEW 2016	GAUGE/BORE	CODE NUMBER	SUGGESTED RETAIL	BARREL LENGTH Inches	CHOKES Included	CHAMBER Inches	AVERAGE WEIGHT lbs./oz.	OVERALL LENGTH Inches	DROP AT COMB Inches	DROP AT HEEL Inches	LENGTH OF PULL Inches	RIB WIDTH Inches
CYNERGY FIELD													
H	12		018706304	1,869.99	28	F,M,IC	3	7 / 11	45	1-5/8	2	14-1/4	5/16
	12		018706305	1,869.99	26	F,M,IC	3	7 / 9	43	1-5/8	2	14-1/4	5/16
	20		018706604	1,939.99	28	F,M,IC	3	6 / 4	45	1-5/8	2	14-1/4	7/32
	20		018706605	1,939.99	26	F,M,IC	3	6 / 2	43	1-5/8	2	14-1/4	7/32
	28		018706813	1,939.99	28	F,M,IC	2-3/4	6 / 4	45	1-5/8	2	14-1/4	7/32
	28		018706814	1,939.99	26	F,M,IC	2-3/4	6 / 2	43	1-5/8	2	14-1/4	7/32
	.410		018706913	1,939.99	28	F,M,IC	3	6 / 1	45	1-5/8	2	14-1/4	7/32
	.410		018706914	1,939.99	26	F,M,IC	3	5 / 15	43	1-5/8	2	14-1/4	7/32
CYNERGY MICRO MIDAS													
I	20		018701605	1,869.99	26	F,M,IC	3	6 / 2	43-3/4	1-5/8	2	13	7/32
	20		018701606	1,869.99	24	F,M,IC	3	6 / 0	41-3/4	1-5/8	2	13	7/32



FEATHERWEIGHTS.

With a lightweight alloy receiver, carrying a Cynergy Feather all day is a pleasure. The lack of weight, however, is most noticeable when the Cynergy is pulled to the shoulder and swung onto a flushing pheasant or grouse. Concerned about strength? Don't be. Feather models feature steel components where it matters to ensure many seasons in the field.



A CYNERGY FEATHER



Feather 12 Gauge Engraving, Right



B CYNERGY FEATHER COMPOSITE CHARCOAL GRAY



Feather Composite Engraving, Right

A CYNERGY FEATHER

RECEIVER Lightweight alloy with steel breech face • Ultra-low profile • MonoLock Hinge • Engraved receiver **BARREL** Lightweight profile • Ventilated top and side ribs • Matte blued finish **ACTION** Reverse Striker ignition system • Impact Ejectors • Top-tang barrel selector/safety **STOCK** Satin varnish finish • Grade I/II walnut • Inflex recoil pad **FEATURES** Vector Pro lengthened forcing cones • Three Invector-Plus choke tubes • 1/4" stock spacer • Ivory front bead sight **IDEAL USAGE** Hunting/Sporting Clays

B CYNERGY FEATHER COMPOSITE CHARCOAL GRAY

RECEIVER Lightweight alloy with steel breech face • Gold enhanced grayed finish • Ultra-low profile • MonoLock Hinge • Engraved receiver **BARREL** Lightweight profile • Ventilated top and side ribs • Matte blued finish **ACTION** Reverse Striker ignition system • Impact Ejectors • Top-tang barrel selector/safety **STOCK** Charcoal gray composite with black rubber overmolding in grip areas • Adjustable comb **FEATURES** Vector Pro lengthened forcing cones • Three Invector-Plus choke tubes • Inflex recoil pad • 1/4" stock spacer • Ivory front bead sight **IDEAL USAGE** Hunting/Sporting Clays

	NEW 2016 GAUGE	CODE NUMBER	SUGGESTED RETAIL	BARREL LENGTH Inches	CHOKES Included	CHAMBER Inches	AVERAGE WEIGHT lbs. / Oz.	OVERALL LENGTH Inches	DROP AT COMB Inches	DROP AT HEEL Inches	LENGTH OF PULL Inches	RIB WIDTH Inches
CYNERGY FEATHER												
A	12	018703304	2,139.99	28	F,M,I,C	3	6 / 12	45	1-5/8	2	14-1/4	5/16
	12	018703305	2,139.99	26	F,M,I,C	3	6 / 10	43	1-5/8	2	14-1/4	5/16
	20	018703604	2,199.99	28	F,M,I,C	3	5 / 12	45	1-5/8	2	14-1/4	5/16
	20	018703605	2,199.99	26	F,M,I,C	3	5 / 10	43	1-5/8	2	14-1/4	5/16
CYNERGY FEATHER COMPOSITE CHARCOAL GRAY												
	12	018702304	2,069.99	28	F,M,I,C	3	6 / 10	45	1-5/8	2	14-1/4	5/16
B	12	018702305	2,069.99	26	F,M,I,C	3	6 / 8	43	1-5/8	2	14-1/4	5/16





C CYNERGY SPORTING



D CYNERGY SPORTING WITH ADJUSTABLE COMB

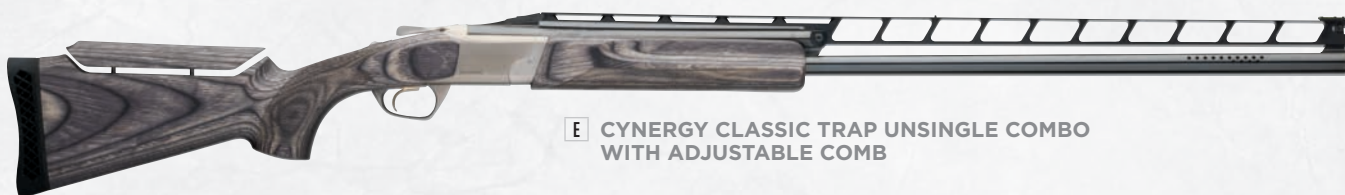

E CYNERGY CLASSIC TRAP UNSINGLE COMBO WITH ADJUSTABLE COMB



A Canvas/Leather fitted case is included with the Cynergy Trap Unsingle Combo.

C CYNERGY SPORTING D CYNERGY SPORTING WITH ADJUSTABLE COMB

RECEIVER Steel • Silver nitride finish • Ultra-low profile • MonoLock Hinge • Engraved receiver **BARREL** Lightweight profile • Ventilated top and side ribs • Ported • Floating top rib • Matte blued finish **ACTION** Reverse Striker ignition system • Impact Ejectors • Top-tang barrel selector/safety **STOCK** Satin varnish finish • Grade I/II walnut • Inflex recoil pad • Available with adjustable comb **FEATURES** Vector Pro lengthened forcing cones • Three Invector-Plus Midas Grade choke tubes • Adjustable length of pull trigger • 1/4" stock spacer • HiViz® Pro-Comp fiber-optic sight • Ivory mid-bead sight **IDEAL USAGE** Skeet/Sporting Clays

E CYNERGY CLASSIC TRAP UNSINGLE COMBO WITH ADJUSTABLE COMB

RECEIVER Steel • Silver nitride finish • Ultra-low profile • MonoLock Hinge • Engraved receiver **BARREL** Double and Unsingle barrel sets included • Lightweight profile over and under barrel set • Single barrel set features an adjustable rib for fine-tuning of rib angle for sight picture and point of impact • Ported • Matte blued finish **ACTION** Reverse Striker ignition system • Impact Ejectors • Top-tang barrel selector/safety **STOCK** Gray laminated Monte Carlo stock with right-hand palm swell • Adjustable comb • Modified semi-beavertail forearm with finger grooves **FEATURES** Vector Pro lengthened forcing cones • Four Invector-Plus Midas Grade choke tubes • Adjustable length of pull trigger • HiViz® Pro-Comp fiber-optic sight • Ivory mid-bead sight • Green canvas/leather fitted case with Cynergy logo **IDEAL USAGE** Trap

NEW 2016	GAUGE	CODE NUMBER	SUGGESTED RETAIL	BARREL LENGTH Inches	CHOKES Included	CHAMBER Inches	AVERAGE WEIGHT Lbs. / Oz.	OVERALL LENGTH Inches	DROP AT COMB Inches	DROP AT HEEL Inches	LENGTH OF PULL Inches	RIB WIDTH Inches
CYNERGY SPORTING												
C	12	018704326	2,399.99	32	M,IC,SK	3	8 / 0	50	1-5/8	2	14-1/4	5/16-7/16
	12	018704327	2,399.99	30	M,IC,SK	3	7 / 14	48	1-5/8	2	14-1/4	5/16-7/16
D CYNERGY SPORTING WITH ADJUSTABLE COMB												
D	12	018705326	2,669.99	32	M,IC,SK	3	8 / 6	50	1-5/8 adj.	2 adj.	14-1/4	5/16-7/16
	12	018705327	2,669.99	30	M,IC,SK	3	8 / 4	48	1-5/8 adj.	2 adj.	14-1/4	5/16-7/16
E CYNERGY CLASSIC TRAP UNSINGLE COMBO WITH ADJUSTABLE COMB												
	12	018707479	4,269.99	32/34	F,F,F,IM	2-3/4	8 / 15	48-1/4 • 50-1/4	1-1/16 adj.	2 adj.	14-3/8	1/4-3/8
	12	018707469	4,269.99	32/32	F,F,F,IM	2-3/4	8 / 15	48-1/4	1-1/16 adj.	2 adj.	14-3/8	1/4-3/8
	12	018707468	4,269.99	30/34	F,F,F,IM	2-3/4	8 / 13	46-1/4 • 50-1/4	1-1/16 adj.	2 adj.	14-3/8	1/4-3/8







Andrew Vavra is part of the crew of *Rooster Road Trip*, an online and Facebook promotion for Pheasants Forever. Learn more about Rooster Road Trip and the rest of the team on page 308.

A TRAP SHOOTING MACHINE.

The BT-99 does one thing and does it well — it crushes clays. For decades, shooters of all abilities have put their trust in the performance of a BT-99 because it has features tailored to the trap range and the toughness to withstand years of both practice and competition.

BT99

BT-99 FEATURES AND BENEFITS



FOREARM

- A beavertail forearm helps control recoil and assists hand-eye coordination.

RIB

- High-post, 11/32" floating rib offers natural sighting and target acquisition.



CHROME CHAMBER

- The chrome-plated chamber resists wear and corrosion.

ALL BROWNING FIREARMS ARE SHIPPED WITH A FREE LOCKING DEVICE TO ASSIST IN THE SAFE STORAGE OF FIREARMS.

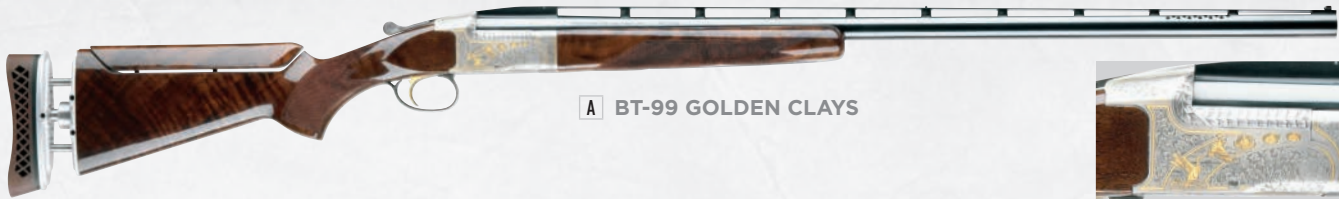

A BT-99 GOLDEN CLAYS



Golden Clays Engraving, Right



B BT-99 PLUS



Plus Engraving, Right

A BT-99 GOLDEN CLAYS

RECEIVER Steel • Silver nitride finish • Gold accented, high-relief engraving **BARREL** High-post ventilated, floating rib • Ported **ACTION** Extractor only **STOCK** Gloss finish Grade V/VI walnut • Ventilated trap recoil pad • Beavertail forearm **FEATURES** Vector Pro lengthened forcing cone • Three Invector-Plus choke tubes • Adjustable straight comb • Adjustable GraCoil® recoil reduction system • Ivory front and mid-bead sights **IDEAL USAGE** Trap

B BT-99 PLUS

RECEIVER Steel • Polished blued finish • High-relief engraving **BARREL** High-post ventilated, floating rib • Ported **ACTION** Ejector only **STOCK** Gloss oil finish Grade III/IV walnut • Pachmayr® Decelerator XLT recoil pad • Modified beavertail forearm **FEATURES** Vector Pro lengthened forcing cone • One Midas Grade Invector-Plus choke tube • Adjustable Monte Carlo comb • Ivory front and mid-bead sights **IDEAL USAGE** Trap

	NEW 2016 GAUGE	CODE NUMBER	SUGGESTED RETAIL	BARREL LENGTH inches	CHOKES Included	CHAMBER inches	AVERAGE WEIGHT lbs. / oz.	OVERALL LENGTH inches	DROP AT COMB inches	DROP AT HEEL inches	LENGTH OF PULL inches	RIB WIDTH inches
BT-99 GOLDEN CLAYS												
	12	017057401	4,339.99	34	F,IM,M	2-3/4	9 / 0	51	1-9/16 adj.	1-3/4 adj.	13-3/8 - 14-3/8	11/32
A	12	017057402	4,339.99	32	F,IM,M	2-3/4	8 / 15	49	1-9/16 adj.	1-3/4 adj.	13-3/8 - 14-3/8	11/32
BT-99 PLUS												
B	12	017080401	2,939.99	34	IM	2-3/4	8 / 7	51	1-1/4 adj.	2 adj.	14-3/8	11/32
	12	017080402	2,939.99	32	IM	2-3/4	8 / 6	49	1-1/4 adj.	2 adj.	14-3/8	11/32



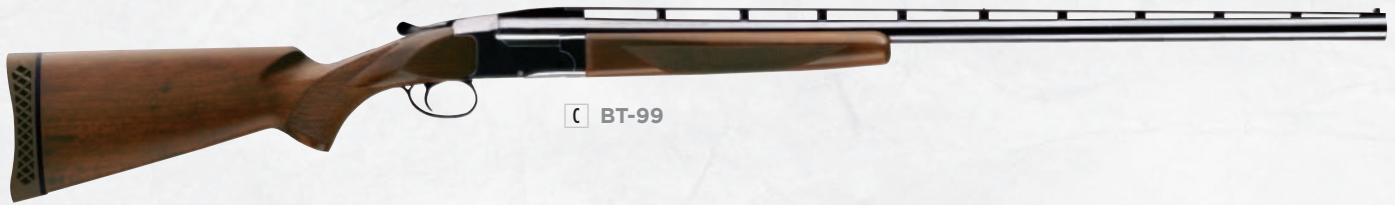

C BT-99

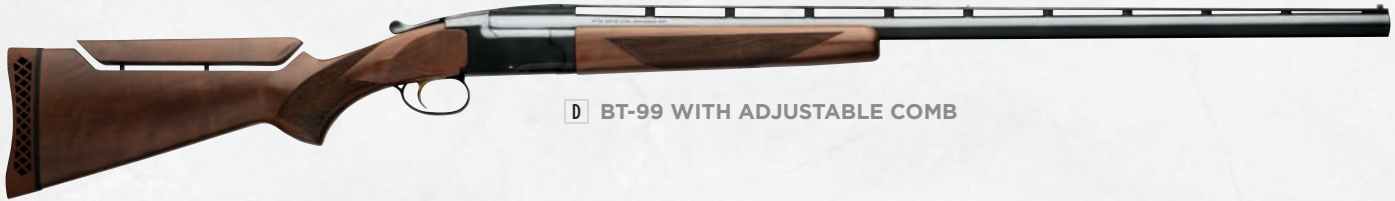

D BT-99 WITH ADJUSTABLE COMB



E BT-99 MICRO



F BT-99 MICRO MIDAS

C BT-99 D BT-99 WITH ADJUSTABLE COMB

RECEIVER Steel • Blued finish **BARREL** High-post ventilated, floating rib **ACTION** Extractor only **STOCK** Satin finish walnut • Ventilated trap recoil pad • Available with adjustable comb • Beavertail forearm **FEATURES** Vector Pro lengthened forcing cone • One Invector-Plus choke tube • Ivory front and mid-bead sights **IDEAL USAGE** Trap

E BT-99 MICRO F BT-99 MICRO MIDAS

RECEIVER Steel • Blued finish **BARREL** High-post ventilated, floating rib **ACTION** Extractor only **STOCK** Satin finish walnut • Ventilated trap recoil pad • Beavertail forearm • Scaled down to comfortably fit smaller shooters **FEATURES** Vector Pro lengthened forcing cone • One Invector-Plus choke tube • Ivory front and mid-bead sights **IDEAL USAGE** Trap **ELIGIBLE FOR THE GROWTH INSURANCE PROGRAM** See page 4 for details

	NEW 2016 GAUGE	CODE NUMBER	SUGGESTED RETAIL	BARREL LENGTH Inches	CHOKES Included	CHAMBER Inches	AVERAGE WEIGHT Lbs. / Oz.	OVERALL LENGTH Inches	DROP AT COMB Inches	DROP AT HEEL Inches	LENGTH OF PULL Inches	RIB WIDTH Inches
BT-99												
	12	017054401	1,429.99	34	Full	2-3/4	8 / 5	51	1-7/16	1-5/8	14-3/8	11/32
C	12	017054402	1,429.99	32	Full	2-3/4	8 / 4	49	1-7/16	1-5/8	14-3/8	11/32
BT-99 WITH ADJUSTABLE COMB												
	12	017055401	1,679.99	34	Full	2-3/4	8 / 5	51	1-9/16 adj.	1-3/4 adj.	14-3/8	11/32
D	12	017055402	1,679.99	32	Full	2-3/4	8 / 4	49	1-9/16 adj.	1-3/4 adj.	14-3/8	11/32
BT-99 MICRO												
E	12	017061402	1,429.99	32	Full	2-3/4	7 / 13	48-1/2	1-7/16	1-5/8	13-3/4	11/32
	12	017061403	1,429.99	30	Full	2-3/4	7 / 12	46-1/2	1-7/16	1-5/8	13-3/4	11/32
BT-99 MICRO MIDAS												
	12	017075403	1,429.99	30	IM	2-3/4	7 / 12	45-3/4	1-7/16	1-5/8	13	11/32
F	12	017075404	1,429.99	28	IM	2-3/4	7 / 11	45-3/4	1-7/16	1-5/8	13	11/32



SSSSWWEEEEEEEEEEEEEEET. . .

In the past, if your hunting buddy said he wanted a “Sweet Sixteen,” you knew he wanted a Browning Auto-5 in 16 gauge. Maybe it was the sweet way the gun handled or it might have just had something to do with the way the phrase “Sweet Sixteen” rolled off the tongue. Regardless, it has been synonymous with Browning humpback autoloaders for decades. With this year being 2016, it just feels like the right time to bring back this Browning favorite, albeit with a modern twist. Often referred to as the “Gentleman’s Gauge,” the in-between 16 is, to many hunters, the ideal ammunition for the perfect gun. A well designed 16 gauge is closer in weight to a 20 gauge, with a shot payload nearer the 12 gauge, with patterning that bests them both. Like its most revered predecessor, the new Browning A5 16 gauge is built on a smaller, lighter receiver for reduced weight and a sleek feel that simply takes your breath away. It also benefits from the advantages of modern technology and testing to extract the most performance from this most revered gauge. Pick up a new A5 Sweet Sixteen and see how sweet it is.



A5 FEATURES AND BENEFITS.



ERGO BALANCED

- Incredibly balanced in the hands from pad to muzzle.
- Facilitates a light feel and fast swing.
- Promotes smoother follow through.
- Places front hand closer to the bore line for superior hand eye coordination and pointability.



TURNKEY MAGAZINE PLUG

- The patented TurnKey Magazine Plug is easily removed in seconds using a car key.

100,000
ROUND GUARANTEE
OR FIVE YEARS



GET THE HUMPBACK ACQUISITION ADVANTAGE

- Extends the sight plane for faster, more natural sight alignment.
- Speeds target acquisition.

ALL BROWNING FIREARMS ARE SHIPPED WITH A FREE LOCKING DEVICE TO ASSIST IN THE SAFE STORAGE OF FIREARMS.



SPEED LOAD PLUS

- Patented feeding system sends the first shell loaded into the magazine directly into the chamber.
- Speed Unload feature makes emptying the magazine fast and easy, without chambering and ejecting every shell with the bolt handle.



A5[®] sweet sixteen



A A5 SWEET SIXTEEN



Sweet Sixteen Detailing



Sharp 18 Lines-Per-Inch Checkering

RECEIVER Strong, lightweight aluminum alloy • Black anodized bi-tone finish **BARREL** Lightweight profile • Flat, ventilated rib **ACTION** 2-3/4" chamber • Recoil-operated Kinematic Drive **STOCK** Gloss finish walnut with close radius pistol grip • Sharp 18 lines-per-inch checkering • Shim adjustable for length of pull, cast and drop • 1/4" and 1/2" stock spacers for length of pull adjustment **FEATURES** Vector Pro lengthened forcing cone • Three Invector-DS choke tubes • Inflex recoil pad • Fiber-optic front sight • Ivory mid-bead sight • Includes ABS case **IDEAL USAGE** Hunting/Sporting Clays

NEW 2016	GAUGE	CODE NUMBER	SUGGESTED RETAIL	BARREL LENGTH Inches	CHOKES Included	CHAMBER Inches	AVERAGE WEIGHT lbs. / Oz.	OVERALL LENGTH Inches	DROP AT COMB Inches	DROP AT HEEL Inches	LENGTH OF PULL Inches	RIB WIDTH Inches
A5 SWEET SIXTEEN												
A	• 16	0118005004	1,699.99	28	F,M,IC	2-3/4	5 / 13	49-1/4	1-3/4	2	14-1/4	1/4
	• 16	0118005005	1,699.99	26	F,M,IC	2-3/4	5 / 12	47-1/4	1-3/4	2	14-1/4	1/4



KINEMATIC DRIVE

KINEMATIC DRIVE SYSTEM

- Kinetic energy is defined as the energy of motion.
- The A5 uses kinetic energy to power the recoil-operated Kinematic Drive System.
- Simplicity of design for consistent, reliable function with any load and under the full extremes of weather, temperature, moisture and grime.
- Kinematic Drive is so reliable that the A5 is the first ever autoloading shotgun to carry a 100,000-round or five-year guarantee – come hell or high water.
- Clean operation because gases are sent out the barrel and away from the action.
- Extreme load versatility for reliable performance with virtually all loads down to one ounce field with no adjustments.



ERGONOMIC BOLT LATCH

- Conveniently located just ahead of the trigger guard.
- Locks the bolt to the rear when the magazine is unloaded and releases a shell from the magazine when the bolt is closed for faster loading.
- Oversized shape makes the bolt latch easy to locate and operate with or without gloves.



ABS CASE INCLUDED

- This sturdy, lockable ABS case is perfect for storing and transporting the A5.





TOMMY THACKER

Counted among the best 3-Gun competitors in the nation, Tommy Thacker has his choice among autoloading shotguns. He chooses the Browning A5. Read more about Tommy on page 312.

TRADITIONAL IN NAME ONLY.

While the new A5 may resemble the humpbacked Browning shotguns so many of you grew up admiring, these new guns are anything but traditional. Featuring cutting edge design and technology, these A5's are poised to be the shotguns the next generation will remember.



A A5 ULTIMATE

RECEIVER Strong, lightweight aluminum alloy • Satin finish with brushed accents • Engraving pattern depicts pheasants on the left side and mallards on the right side, all surrounded by intricate scrollwork **BARREL** Lightweight profile • Flat, ventilated rib • Gloss blued finish **ACTION** 3" chamber • Recoil-operated Kinematic Drive **STOCK** Grade III gloss oil finish walnut with close radius pistol grip • Sharp 22 lines-per-inch checkering • Shim adjustable for length of pull, cast and drop • 1/4" and 1/2" stock spacers for length of pull adjustment **FEATURES** Vector Pro lengthened forcing cone • Three Invector-DS choke tubes • Inflex recoil pad • Fiber-optic front sight • Ivory mid-bead sight • Includes ABS case **IDEAL USAGE** Hunting/Sporting Clays

NEW 2016	GAUGE	CODE NUMBER	SUGGESTED RETAIL	BARREL LENGTH Inches	CHOKES Included	CHAMBER Inches	AVERAGE WEIGHT Lbs. / Oz.	OVERALL LENGTH Inches	DROP AT COMB Inches	DROP AT HEEL Inches	LENGTH OF PULL Inches	RIB WIDTH Inches
A5 ULTIMATE												
A	12	0118203004	1,989.99	28	F,M,IC	3	6 / 11	49-5/8	1-3/4	2	14-1/4	1/4
	12	0118203005	1,989.99	26	F,M,IC	3	6 / 11	47-5/8	1-3/4	2	14-1/4	1/4





B A5, MOSSY OAK® SHADOW GRASS BLADES

C A5, MOSSY OAK® BREAK-UP COUNTRY®

D A5 HUNTER

E A5 STALKER

B A5, MOSSY OAK SHADOW GRASS BLADES C A5, MOSSY OAK BREAK-UP COUNTRY E A5 STALKER

RECEIVER Strong, lightweight aluminum alloy **BARREL** Lightweight profile • Flat, ventilated rib **ACTION** 3" and 3-1/2" chamber models • Recoil-operated Kinematic Drive **STOCK** Composite with close radius pistol grip • Textured gripping surfaces • Shim adjustable for length of pull, cast and drop • Matte black or Mossy Oak® camo finishes • Dura-Touch Armor Coating • 1/4" and 1/2" stock spacers for length of pull adjustment **FEATURES** Vector Pro lengthened forcing cone • Three Invector-DS choke tubes • Inflex recoil pad • Fiber-optic front sight • Ivory mid-bead sight • Includes ABS case **IDEAL USAGE** Hunting/Sporting Clays/Turkey

D A5 HUNTER

RECEIVER Strong, lightweight aluminum alloy • Black anodized bi-tone finish **BARREL** Lightweight profile • Flat, ventilated rib **ACTION** 3" and 3-1/2" chamber models • Recoil-operated Kinematic Drive **STOCK** Gloss finish walnut with close radius pistol grip • Sharp 18 lines-per-inch checkering • Shim adjustable for length of pull, cast and drop • 1/4" and 1/2" stock spacers for length of pull adjustment **FEATURES** Vector Pro lengthened forcing cone • Three Invector-DS choke tubes • Inflex recoil pad • Fiber-optic front sight • Ivory mid-bead sight • Includes ABS case **IDEAL USAGE** Hunting/Sporting Clays

NEW 2016	GAUGE	CODE NUMBER	SUGGESTED RETAIL	BARREL LENGTH Inches	CHOKES Included	CHAMBER Inches	AVERAGE WEIGHT Lbs./ Oz.	OVERALL LENGTH Inches	DROP AT COMB Inches	DROP AT HEEL Inches	LENGTH OF PULL Inches	RIB WIDTH Inches
A5, MOSSY OAK SHADOW GRASS BLADES												
	12	0118182003	1,759.99	30	F,M,IC	3-1/2	7 / 7	51-5/8	1-3/4	2	14-1/4	1/4
	12	0118182004	1,759.99	28	F,M,IC	3-1/2	7 / 5	49-5/8	1-3/4	2	14-1/4	1/4
B	12	0118182005	1,759.99	26	F,M,IC	3-1/2	7 / 3	47-5/8	1-3/4	2	14-1/4	1/4
	12	0118183003	1,629.99	30	F,M,IC	3	7 / 7	51-5/8	1-3/4	2	14-1/4	1/4
	12	0118183004	1,629.99	28	F,M,IC	3	7 / 5	49-5/8	1-3/4	2	14-1/4	1/4
	12	0118183005	1,629.99	26	F,M,IC	3	7 / 3	47-5/8	1-3/4	2	14-1/4	1/4
A5, MOSSY OAK BREAK-UP COUNTRY												
C	12	0118332003	1,759.99	30	F,M,IC	3-1/2	7 / 7	51-5/8	1-3/4	2	14-1/4	1/4
	12	0118332004	1,759.99	28	F,M,IC	3-1/2	7 / 5	49-5/8	1-3/4	2	14-1/4	1/4
	12	0118332005	1,759.99	26	F,M,IC	3-1/2	7 / 3	47-5/8	1-3/4	2	14-1/4	1/4
	12	0118333003	1,629.99	30	F,M,IC	3	7 / 7	51-5/8	1-3/4	2	14-1/4	1/4
	12	0118333004	1,629.99	28	F,M,IC	3	7 / 5	49-5/8	1-3/4	2	14-1/4	1/4
	12	0118333005	1,629.99	26	F,M,IC	3	7 / 3	47-5/8	1-3/4	2	14-1/4	1/4
A5 HUNTER												
	12	0118002003	1,759.99	30	F,M,IC	3-1/2	6 / 15	51-5/8	1-3/4	2	14-1/4	1/4
	12	0118002004	1,759.99	28	F,M,IC	3-1/2	6 / 13	49-5/8	1-3/4	2	14-1/4	1/4
D	12	0118002005	1,759.99	26	F,M,IC	3-1/2	6 / 11	47-5/8	1-3/4	2	14-1/4	1/4
	12	0118003003	1,629.99	30	F,M,IC	3	6 / 15	51-5/8	1-3/4	2	14-1/4	1/4
	12	0118003004	1,629.99	28	F,M,IC	3	6 / 13	49-5/8	1-3/4	2	14-1/4	1/4
	12	0118003005	1,629.99	26	F,M,IC	3	6 / 11	47-5/8	1-3/4	2	14-1/4	1/4
A5 STALKER												
	12	0118012003	1,629.99	30	F,M,IC	3-1/2	7 / 7	51-5/8	1-3/4	2	14-1/4	1/4
	12	0118012004	1,629.99	28	F,M,IC	3-1/2	7 / 5	49-5/8	1-3/4	2	14-1/4	1/4
E	12	0118012005	1,629.99	26	F,M,IC	3-1/2	7 / 3	47-5/8	1-3/4	2	14-1/4	1/4
	12	0118013003	1,499.99	30	F,M,IC	3	7 / 7	51-5/8	1-3/4	2	14-1/4	1/4
	12	0118013004	1,499.99	28	F,M,IC	3	7 / 5	49-5/8	1-3/4	2	14-1/4	1/4
	12	0118013005	1,499.99	26	F,M,IC	3	7 / 3	47-5/8	1-3/4	2	14-1/4	1/4

MAXUS FEATURES AND BENEFITS

POWER DRIVE GAS SYSTEM



POWER DRIVE GAS SYSTEM

- Extensive research has produced the most reliable gas piston design ever.
- The gas piston features oversized exhaust ports that dump gases faster with heavy loads to reduce recoil.
- 20% longer piston stroke travel increases reliability with light loads.
- An enclosed seal keeps residue out of the action for cleaner operation.

TURNKEY MAGAZINE PLUG

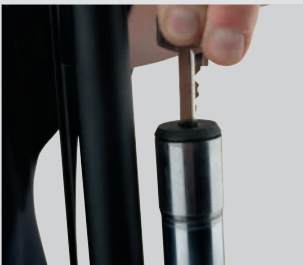

TURNKEY MAGAZINE PLUG

- The patented TurnKey Magazine Plug is easily removed in seconds using a standard car key.



MAGAZINE CUT-OFF

- The magazine cut-off (not available on Sporting models) allows the chamber to be unloaded to change loads without cycling a shell from the magazine.
- Useful when hunting different bird species and different loads are instantly required.

SPEED LOCK FOREARM



SPEED LOCK FOREARM

- The patented Speed Lock Forearm replaces the traditional screw-on magazine cap.
- Speeds take down for cleaning and storage.
- Makes attaching or removing the sling a snap.

SPEED LOAD PLUS

SPEED LOAD PLUS

- Patented feeding system sends the first shell loaded into the magazine directly into the chamber.
- Speed Unload feature makes emptying the magazine fast and easy, without chambering and ejecting every shell with the bolt handle.

OPTIMAL DIMENSIONS

- The Maxus features a trim forearm and close radius pistol grip to maximize control.
- An externally relieved steel magazine tube reduces weight for a faster swing while retaining durability.
- Drop and cast can be tuned using the included stock shim kit.
- A low rib is in line with the top of the receiver and translates into dead-flat point of impact.

LIGHTNING TRIGGER

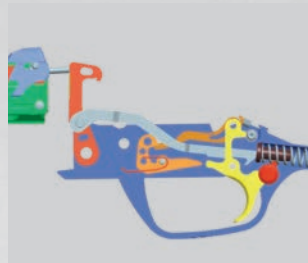

LIGHTNING TRIGGER

- The Lightning Trigger is the finest fire control system ever offered in an autoloading shotgun.
- Offers a smooth, crisp feel with minimal travel.
- Lock times average .0052 seconds, 24% faster than the nearest competing autoloader.
- Easy to remove for cleaning.

THE SOFTEST SHOOTING AUTOLOADER EVER

- Felt recoil is more than an instantaneous peak force; it is the total energy absorbing experience felt when a shell is fired.
- The Power Drive Gas System, Inflex Technology recoil pad, back-boring and natural Browning balance combine to transfer up to 18% less total felt recoil force to the shoulder than other autoloaders on the market.

MAXUS®

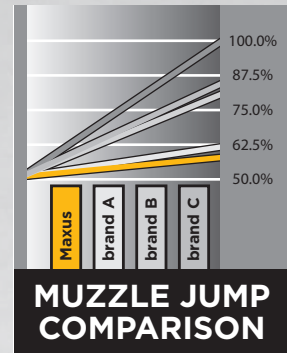

LESS MUZZLE JUMP

- The Power Drive Gas System works with the Inflex Technology recoil pad.
- Reduces muzzle jump up to 44% compared to the competition.

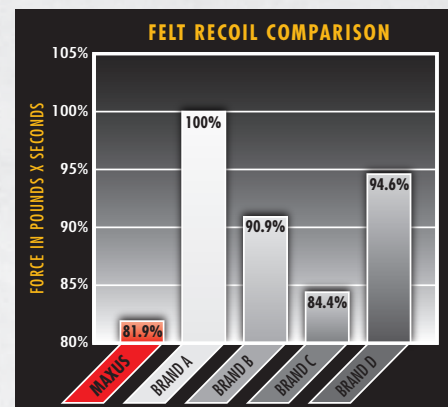
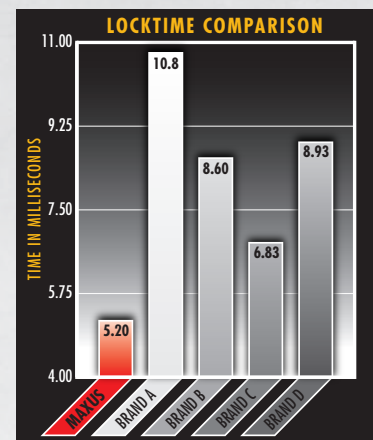

ALL BROWNING FIREARMS ARE SHIPPED WITH A FREE LOCKING DEVICE TO ASSIST IN THE SAFE STORAGE OF FIREARMS.

SPEED AND RELIABILITY TO THE MAX.

The Browning Maxus lives up to its reputation of maximum performance, maximum reliability and maximum cycling speed. This premium gas-operated autoloader is loaded with features and designed to exceed expectations every time you bring it to your shoulder.



A MAXUS ULTIMATE

Ultimate Engraving, Left



B MAXUS HUNTER

Hunter Engraving, Right

Hunter Engraving, Left

A MAXUS ULTIMATE

RECEIVER Strong, lightweight aluminum alloy • Durable satin nickel finish • Laser engraving (pheasants on the right, mallards on the left) **BARREL** Lightweight profile • Flat, ventilated rib **ACTION** Gas-operated autoloader • 3" chamber • Power Drive Gas System reduces recoil and cycles a wide range of loads • Polished, engine-turned bolt finish **STOCK** Gloss oil finish Grade III walnut with close radius pistol grip • Sharp 22 lines-per-inch checkering • Speed Lock Forearm • Shim adjustable for length of pull, cast and drop • Two 1/4" stock spacers for length of pull adjustment **FEATURES** Vector Pro lengthened forcing cone • Three Invector-Plus choke tubes • Inflex recoil pad • Magazine Cut-Off • Brass front bead sight • Includes ABS case **IDEAL USAGE** Hunting/Sporting Clays

B MAXUS HUNTER

RECEIVER Strong, lightweight aluminum alloy • Durable satin nickel finish • Laser engraving (pheasant on the right, mallard on the left) **BARREL** Lightweight profile • Flat, ventilated rib **ACTION** Gas-operated autoloader • 3" and 3-1/2" chambered models • Power Drive Gas System reduces recoil and cycles a wide range of loads **STOCK** Gloss finish Grade I walnut with close radius pistol grip • Sharp 22 lines-per-inch checkering • Speed Lock Forearm • Shim adjustable for length of pull, cast and drop • One 1/4" stock spacer for length of pull adjustment **FEATURES** Vector Pro lengthened forcing cone • Three Invector-Plus choke tubes • Inflex recoil pad • Magazine Cut-Off • Brass front bead sight • Ivory mid-bead sight **IDEAL USAGE** Hunting/Sporting Clays

	NEW 2016	GAUGE	CODE NUMBER	SUGGESTED RETAIL	BARREL LENGTH Inches	CHOICES Included	CHAMBER Inches	AVERAGE WEIGHT Lbs./ Oz.	OVERALL LENGTH Inches	DROP AT COMB Inches	DROP AT HEEL Inches	LENGTH OF PULL Inches	RIB WIDTH Inches
MAXUS ULTIMATE													
		12	011640303	1,939.99	30	F,M,IC	3	7 / 4	51	1-3/4	2	14-1/4	1/4
A		12	011640304	1,939.99	28	F,M,IC	3	7 / 3	49	1-3/4	2	14-1/4	1/4
		12	011640305	1,939.99	26	F,M,IC	3	7 / 1	47	1-3/4	2	14-1/4	1/4
MAXUS HUNTER													
B		12	011608203	1,699.99	30	F,M,IC	3-1/2	7 / 4	51	1-3/4	2	14-1/4	1/4
		12	011608204	1,699.99	28	F,M,IC	3-1/2	7 / 3	49	1-3/4	2	14-1/4	1/4
		12	011608205	1,699.99	26	F,M,IC	3-1/2	7 / 1	47	1-3/4	2	14-1/4	1/4
		12	011608303	1,549.99	30	F,M,IC	3	7 / 4	51	1-3/4	2	14-1/4	1/4
		12	011608304	1,549.99	28	F,M,IC	3	7 / 3	49	1-3/4	2	14-1/4	1/4
		12	011608305	1,549.99	26	F,M,IC	3	7 / 1	47	1-3/4	2	14-1/4	1/4



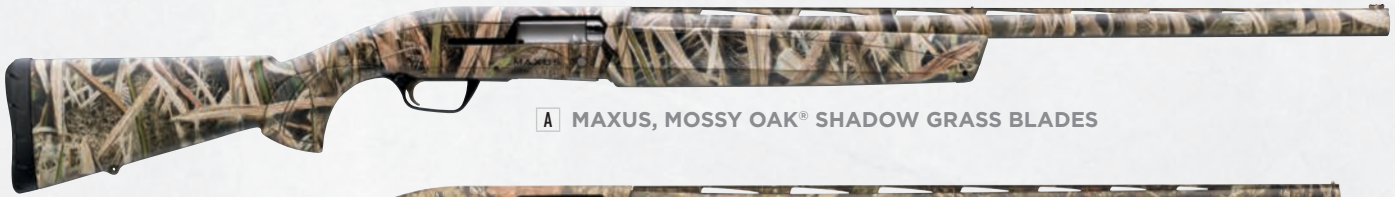

A MAXUS, MOSSY OAK® SHADOW GRASS BLADES

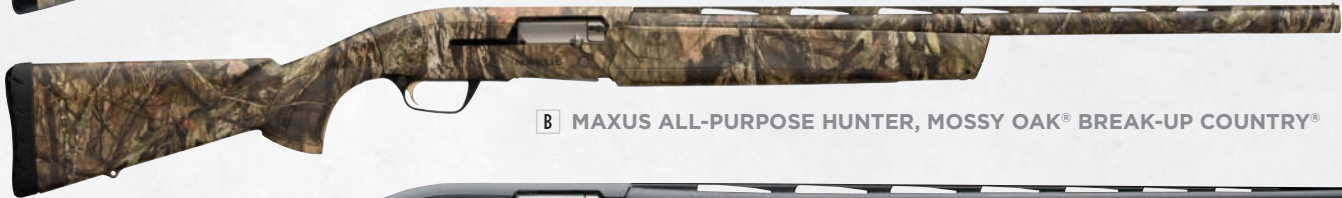

B MAXUS ALL-PURPOSE HUNTER, MOSSY OAK® BREAK-UP COUNTRY®



C MAXUS STALKER



D MAXUS RIFLED DEER, MOSSY OAK® BREAK-UP COUNTRY®



E MAXUS RIFLED DEER STALKER

A MAXUS, MOSSY OAK SHADOW GRASS BLADES

B MAXUS ALL-PURPOSE HUNTER, MOSSY OAK BREAK-UP COUNTRY C MAXUS STALKER

RECEIVER Strong, lightweight aluminum alloy **BARREL** Lightweight profile • Flat, ventilated rib **ACTION** Gas-operated autoloader • 3" and 3-1/2" chambered models • Power Drive Gas System reduces recoil and cycles a wide range of loads **STOCK** Composite with close radius pistol grip • Speed Lock Forearm • Textured gripping surfaces • Shim adjustable for length of pull, cast and drop • One 1/4" stock spacer for length of pull adjustment • Matte black or Mossy Oak® camo finishes • Dura-Touch Armor Coating **FEATURES** Vector Pro lengthened forcing cone • Three Invector-Plus choke tubes (All-Purpose Hunter also includes X-Tra Full Turkey tube) • Inflex recoil pad • Magazine Cut-Off • Fiber-optic front sight • Ivory mid-bead sight • All-Purpose Hunter includes a HiViz® magnetic combo sight set for turkey hunting and a brass bead front sight **IDEAL USAGE** Hunting/Sporting Clays/Turkey

D MAXUS RIFLED DEER, MOSSY OAK BREAK-UP COUNTRY E MAXUS RIFLED DEER STALKER

RECEIVER Strong, lightweight aluminum alloy **BARREL** Thick-walled, fully rifled for slug ammunition **ACTION** Gas-operated autoloader • 3" chamber • Power Drive Gas System reduces recoil and cycles a wide range of loads **STOCK** Composite with close radius pistol grip • Speed Lock Forearm • Textured gripping surfaces • Shim adjustable for length of pull, cast and drop • One 1/4" stock spacer for length of pull adjustment • Matte black or Mossy Oak® camo finish • Dura-Touch Armor Coating **FEATURES** Cantilever scope mount • Inflex recoil pad **IDEAL USAGE** Deer Hunting

NEW 2016	GAUGE	CODE NUMBER	SUGGESTED RETAIL	BARREL LENGTH Inches	CHOKES Included	CHAMBER Inches	AVERAGE WEIGHT Lbs./Oz.	OVERALL LENGTH Inches	DROP AT COMB Inches	DROP AT HEEL Inches	LENGTH OF PULL Inches	RIB WIDTH Inches
MAXUS, MOSSY OAK SHADOW GRASS BLADES												
A	12	011645204	1,659.99	28	F,M,IC	3-1/2	7 / 2	49-1/4	1-3/4	2	14-1/4	1/4
	12	011645205	1,659.99	26	F,M,IC	3-1/2	7 / 0	47-1/4	1-3/4	2	14-1/4	1/4
	12	011645304	1,519.99	28	F,M,IC	3	7 / 3	49-1/4	1-3/4	2	14-1/4	1/4
	12	011645305	1,519.99	26	F,M,IC	3	7 / 0	47-1/4	1-3/4	2	14-1/4	1/4
MAXUS ALL PURPOSE HUNTER, MOSSY OAK BREAK-UP COUNTRY												
B	12	011659205	1,739.99	26	XF,F,M,IC	3-1/2	7 / 1	47-1/4	1-3/4	2	14-1/4	1/4
MAXUS STALKER												
C	12	011600204	1,549.99	28	F,M,IC	3-1/2	7 / 2	49-1/4	1-3/4	2	14-1/4	1/4
	12	011600205	1,549.99	26	F,M,IC	3-1/2	7 / 0	47-1/4	1-3/4	2	14-1/4	1/4
	12	011600304	1,379.99	28	F,M,IC	3	7 / 2	49-1/4	1-3/4	2	14-1/4	1/4
	12	011600305	1,379.99	26	F,M,IC	3	7 / 0	47-1/4	1-3/4	2	14-1/4	1/4
MAXUS RIFLED DEER, MOSSY OAK BREAK-UP COUNTRY												
D	12	011660321	1,639.99	22	Rif. Bbl./Cant.	3	7 / 3	43-1/4	1-3/4	2	14-1/4	28
MAXUS RIFLED DEER STALKER												
E	12	011620321	1,519.99	22	Rif. Bbl./Cant.	3	7 / 3	43-1/4	1-3/4	2	14-1/4	28



F MAXUS SPORTING GOLDEN CLAYS



Golden Clays Engraving, Top



Golden Clays Engraving, Right



Golden Clays Engraving, Left



G MAXUS SPORTING



H MAXUS SPORTING CARBON FIBER

F MAXUS SPORTING GOLDEN CLAYS

RECEIVER Strong, lightweight aluminum alloy • Durable satin nickel finish • Gold enhanced engravings of game birds transforming into a clay target (quail on the right, mallard on the left)
BARREL Lightweight profile • Flat, ventilated rib **ACTION** Gas-operated autoloader • 3" chamber • Power Drive Gas System reduces recoil and cycles a wide range of loads • Polished, engine-turned bolt finish **STOCK** Gloss varnish finish High Grade walnut with close radius pistol grip • Sharp 22 lines-per-inch checkering • Speed Lock Forearm • Shim adjustable for length of pull, cast and drop • Two 1/4" stock spacers for length of pull adjustment **FEATURES** Vector Pro lengthened forcing cone • Five Invector-Plus choke tubes • Inflex recoil pad • HiViz® TriComp fiber-optic front sight • Ivory mid-bead sight • Includes ABS case **IDEAL USAGE** Hunting/Sporting Clays

G MAXUS SPORTING

RECEIVER Strong, lightweight aluminum alloy • Durable satin nickel finish • Full coverage, high-relief engraving features game birds transforming into a clay target (quail on the right, mallard on the left) **BARREL** Lightweight profile • Flat, ventilated rib **ACTION** Gas-operated autoloader • 3" chamber • Power Drive Gas System reduces recoil and cycles a wide range of loads **STOCK** Gloss varnish finish High Grade walnut with close radius pistol grip • Sharp 22 lines-per-inch checkering • Speed Lock Forearm • Shim adjustable for length of pull, cast and drop • Two 1/4" stock spacers for length of pull adjustment **FEATURES** Vector Pro lengthened forcing cone • Five Invector-Plus choke tubes • Inflex recoil pad • HiViz® TriComp fiber-optic front sight • Ivory mid-bead sight • Includes ABS case **IDEAL USAGE** Hunting/Sporting Clays

H MAXUS SPORTING CARBON FIBER

RECEIVER Strong, lightweight aluminum alloy • Carbon fiber finish on top and bottom **BARREL** Lightweight profile • Flat, ventilated rib • Carbon fiber finish **ACTION** Gas-operated autoloader • 3" chamber • Power Drive Gas System reduces recoil and cycles a wide range of loads **STOCK** Composite with close radius pistol grip • Speed Lock Forearm • Textured gripping surfaces • Shim adjustable for length of pull, cast and drop • Carbon fiber finish • Dura-Touch Armor Coating • Two 1/4" stock spacers for length of pull adjustment **FEATURES** Vector Pro lengthened forcing cone • Five Invector-Plus choke tubes • Inflex recoil pad • HiViz® TriComp fiber-optic front sight • Ivory mid-bead sight • Includes ABS case **IDEAL USAGE** Hunting/Sporting Clays

NEW 2016	GAUGE	CODE NUMBER	SUGGESTED RETAIL	BARREL LENGTH Inches	CHOKES Included	CHAMBER Inches	AVERAGE WEIGHT Lbs./Oz.	OVERALL LENGTH Inches	DROP AT COMB Inches	DROP AT HEEL Inches	LENGTH OF PULL Inches	RIB WIDTH Inches
MAXUS SPORTING GOLDEN CLAYS												
F	12	011635303	2,069.99	30	F,IM,M,IC,SK	3	7 / 4	51	1-3/4	2	14-1/4	1/4-5/16
	12	011635304	2,069.99	28	F,IM,M,IC,SK	3	7 / 3	49	1-3/4	2	14-1/4	1/4-5/16
MAXUS SPORTING												
	12	011616303	1,759.99	30	F,IM,M,IC,SK	3	7 / 4	51	1-3/4	2	14-1/4	1/4-5/16
G	12	011616304	1,759.99	28	F,IM,M,IC,SK	3	7 / 3	49	1-3/4	2	14-1/4	1/4-5/16
MAXUS SPORTING CARBON FIBER												
	12	011609303	1,549.99	30	F,IM,M,IC,SK	3	7 / 3	51	1-3/4	2	14-1/4	1/4-5/16
H	12	011609304	1,549.99	28	F,IM,M,IC,SK	3	7 / 2	49	1-3/4	2	14-1/4	1/4-5/16



PERFORMANCE AND MORE.

Adding features to a new car quickly drives up the price. The same goes for shotguns. Some of you just want a high-quality, long-lasting autoloader that simply gets the job done every time you pull the trigger. The Silver fills that role with genuine Browning style.



SILVER FEATURES AND BENEFITS



LESS RECOIL WITH THE ACTIVE VALVE

- The self-adjusting Active Valve gas system in Silver autoloaders diverts gases from fired shells to operate the action instead of adding to recoil.
- When shooting light loads, most of the gases operate the action.
- With magnum loads, only a small amount of gas is necessary to operate the action, while the remaining gases are vented out the top of the forearm and away from the receiver for cleaner, more reliable operation.
- Superior recoil reduction from the Active Valve means faster, more accurate follow-up shots and all-day shooting comfort regardless of the loads being fired.



MAXIMUM GRIP

- Composite Silver models combine checkered gripping surfaces and proven Dura-Touch Armor Coating for a sure hold and a sleek feel in all climate conditions.



TRIGGER

- The trigger assembly can be removed in just seconds for a thorough cleaning.
- The trigger guard is large and has carefully rounded edges to accommodate gloved fingers.

LOAD VERSATILITY

- The Active Valve-equipped gas piston efficiently adjusts to reliably fire a wide range of loads.
- 12 gauge 3" models fire everything from light, 1 oz., 2-3/4" field loads to the heaviest 3" magnums. The 3-1/2" version is built to handle a similar range, from 1-1/8 oz., 2-3/4" field loads up to hard-hitting 3-1/2" magnum loads.

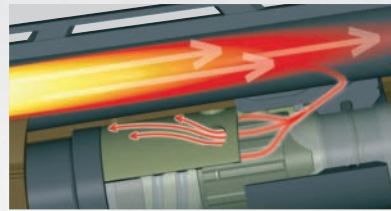

Light Load (1 oz.)

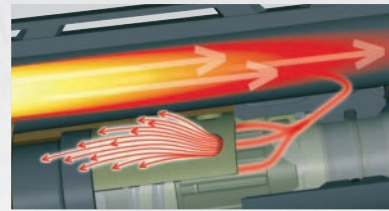

Heavy Load (2 oz.)

ALL BROWNING FIREARMS ARE SHIPPED WITH A FREE LOCKING DEVICE TO ASSIST IN THE SAFE STORAGE OF FIREARMS.



A SILVER LIGHTNING, FULL LINE DEALER



RECEIVER Strong, lightweight aluminum alloy • Semi-humpback design • Silver finish **BARREL** Lightweight profile • Ventilated rib **ACTION** Gas-operated autoloader • 3" chamber • Active Valve System reliably cycles a wide range of loads **STOCK** Lightning-style, gloss finish walnut **FEATURES** Three Invector-Plus choke tubes • Brass front bead sight • Available only from Browning Full Line and Medallion Dealers **IDEAL USAGE** Hunting/Sporting Clays

NEW 2016 GAUGE	CODE NUMBER	SUGGESTED RETAIL	BARREL LENGTH Inches	CHOKES Included	CHAMBER Inches	AVERAGE WEIGHT Lbs. / Oz.	OVERALL LENGTH Inches	DROP AT COMB Inches	DROP AT HEEL Inches	LENGTH OF PULL Inches	RIB WIDTH Inches
SILVER LIGHTNING, FULL LINE DEALER											
A 12	011368304	1,199.99	28	F,M,IC	3	7 / 6	49	1-3/4	2	14-1/4	1/4
12	011368305	1,199.99	26	F,M,IC	3	7 / 4	47	1-3/4	2	14-1/4	1/4





B SILVER HUNTER MICRO MIDAS



C SILVER HUNTER



D SILVER SPORTING MICRO

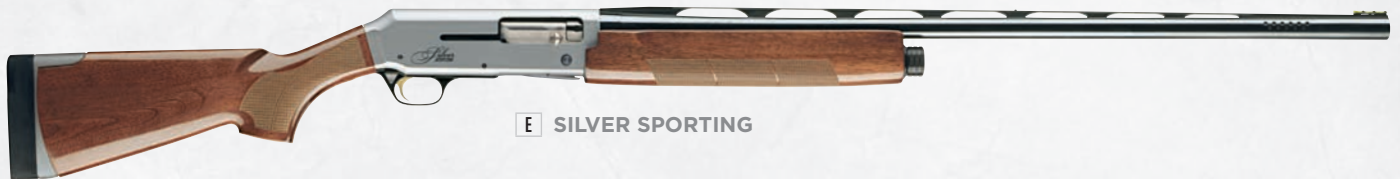

E SILVER SPORTING

B SILVER HUNTER MICRO MIDAS C SILVER HUNTER

RECEIVER Strong, lightweight aluminum alloy • Semi-humpback design • Silver finish **BARREL** Lightweight profile • Ventilated rib **ACTION** Gas-operated autoloader • 3" and 3-1/2" chamber models • Active Valve System reliably cycles a wide range of loads **STOCK** Satin finish walnut • Inflex recoil pad • Micro Midas comes with one 1/4" stock spacer **FEATURES** Three Invector-Plus choke tubes • Brass front bead sight **IDEAL USAGE** Hunting/Sporting Clays **MICRO MIDAS IS ELIGIBLE FOR THE GROWTH INSURANCE PROGRAM** See page 4 for details

D SILVER SPORTING MICRO E SILVER SPORTING

RECEIVER Strong, lightweight aluminum alloy • Semi-humpback design • Silver finish **BARREL** Lightweight profile • Ventilated rib • Ported **ACTION** Gas-operated autoloader • 2-3/4" chamber • Active Valve System reliably cycles a wide range of loads **STOCK** Gloss finish walnut stock and forearm • 3/4" length of pull adjustment in 1/4" increments using the three included adjustment spacers • Premium Pachmayr® Decelerator® recoil pad **FEATURES** Three Invector-Plus choke tubes • Sporting has a HiViz® TriComp fiber-optic sight and mid-bead • Sporting Micro has a brass bead sight and mid-bead • Two Active Valve pistons included to optimize performance with light or heavy loads **IDEAL USAGE** Skeet/Sporting Clays **MICRO IS ELIGIBLE FOR THE GROWTH INSURANCE PROGRAM** See page 4 for details

NEW 2016	GAUGE	CODE NUMBER	SUGGESTED RETAIL	BARREL LENGTH Inches	CHOKES Included	CHAMBER Inches	AVERAGE WEIGHT Lbs./Oz.	OVERALL LENGTH Inches	DROP AT COMB Inches	DROP AT HEEL Inches	LENGTH OF PULL Inches	RIB WIDTH Inches
SILVER HUNTER MICRO MIDAS												
B	12	011389305	1,199.99	26	F,M,IC	3	7 / 5	45-3/4	1-1/2	1-3/4	13	1/4
	12	011389306	1,199.99	24	F,M,IC	3	7 / 3	43-3/4	1-1/2	1-3/4	13	1/4
	20	011389605	1,199.99	26	F,M,IC	3	6 / 2	45-3/4	1-1/2	1-3/4	13	1/4
	20	011389606	1,199.99	24	F,M,IC	3	6 / 0	43-3/4	1-1/2	1-3/4	13	1/4
SILVER HUNTER												
C	12	011350204	1,359.99	28	F,M,IC	3-1/2	7 / 9	49	1-3/4	2	14-1/4	1/4
	12	011350205	1,359.99	26	F,M,IC	3-1/2	7 / 8	47	1-3/4	2	14-1/4	1/4
	12	011350303	1,199.99	30	F,M,IC	3	7 / 6	51	1-3/4	2	14-1/4	1/4
	12	011350304	1,199.99	28	F,M,IC	3	7 / 5	49	1-3/4	2	14-1/4	1/4
	12	011350305	1,199.99	26	F,M,IC	3	7 / 4	47	1-3/4	2	14-1/4	1/4
	20	011350604	1,199.99	28	F,M,IC	3	6 / 7	48-3/4	1-3/4	2-1/4	14-1/4	1/4
	20	011350605	1,199.99	26	F,M,IC	3	6 / 5	46-3/4	1-3/4	2-1/4	14-1/4	1/4
SILVER SPORTING MICRO												
D	12	011373428	1,319.99	28	F,M,IC	2-3/4	7 / 5	48	1-1/2	1-3/4	13-3/8	1/4
SILVER SPORTING												
E	12	011377427	1,319.99	30	F,M,IC	2-3/4	7 / 9	50-3/4	1-1/2	1-3/4	14-1/4 adj.	1/4
	12	011377428	1,319.99	28	F,M,IC	2-3/4	7 / 8	48-3/4	1-1/2	1-3/4	14-1/4 adj.	1/4



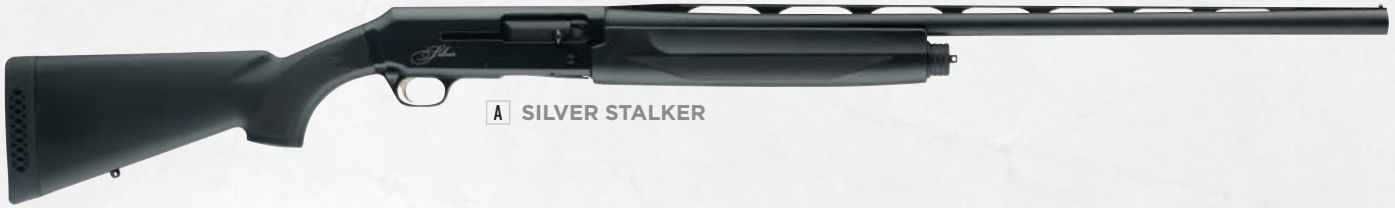

A SILVER STALKER



B SILVER, MOSSY OAK® SHADOW GRASS BLADES



C SILVER, MOSSY OAK® BREAK-UP COUNTRY®



D SILVER NWTF®, MOSSY OAK® BREAK-UP COUNTRY®

A SILVER STALKER

RECEIVER Aluminum alloy • Semi-humpback design **BARREL** Lightweight profile • Ventilated rib **ACTION** Gas-operated autoloader • 3-1/2" chamber • Active Valve System reliably cycles a wide range of loads **STOCK** Composite • Matte black finish • Dura-Touch Armor Coating **FEATURES** Three Invector-Plus choke tubes • Brass front bead sight **IDEAL USAGE** Hunting/Sporting Clays

B SILVER, MOSSY OAK SHADOW GRASS BLADES **C SILVER, MOSSY OAK BREAK-UP COUNTRY**

RECEIVER Aluminum alloy • Semi-humpback design **BARREL** Lightweight profile • Ventilated rib **ACTION** Gas-operated autoloader • 3-1/2" chamber • Active Valve System reliably cycles a wide range of loads **STOCK** Composite • Dura-Touch Armor Coating • Mossy Oak® camo finishes **FEATURES** Three Invector-Plus choke tubes • Brass front bead sight **IDEAL USAGE** Hunting

D SILVER NWTF, MOSSY OAK BREAK-UP COUNTRY

RECEIVER Aluminum alloy • Semi-humpback design • Drilled and tapped for scope mounts **BARREL** Lightweight profile • Ventilated rib **ACTION** Gas-operated autoloader • 3-1/2" chamber • Active Valve System reliably cycles a wide range of loads **STOCK** Composite • Dura-Touch Armor Coating • Mossy Oak® Break-Up Country® camo finish **FEATURES** Three Invector-Plus choke tubes including a Full Strut Turkey tube • HiViz® 4-in-1 fiber-optic sight **IDEAL USAGE** Turkey Hunting

	NEW 2016 GAUGE	CODE NUMBER	SUGGESTED RETAIL	BARREL LENGTH Inches	CHOKES Included	CHAMBER Inches	AVERAGE WEIGHT Lbs. / Oz.	OVERALL LENGTH Inches	DROP AT COMB Inches	DROP AT HEEL Inches	LENGTH OF PULL Inches	RIB WIDTH Inches
SILVER STALKER												
A	12	011351204	1,229.99	28	F,M,IC	3-1/2	7 / 9	49	1-3/4	2	14-1/4	1/4
	12	011351205	1,229.99	26	F,M,IC	3-1/2	7 / 8	47	1-3/4	2	14-1/4	1/4
SILVER, MOSSY OAK SHADOW GRASS BLADES												
B	12	011403204	1,359.99	28	F,M,IC	3-1/2	7 / 9	49	1-3/4	2	14-1/4	1/4
	12	011403205	1,359.99	26	F,M,IC	3-1/2	7 / 8	47	1-3/4	2	14-1/4	1/4
SILVER, MOSSY OAK BREAK-UP COUNTRY												
C	12	011409205	1,359.99	26	F,M,IC	3-1/2	7 / 8	47	1-3/4	2	14-1/4	1/4
SILVER NWTF, MOSSY OAK BREAK-UP COUNTRY												
D	12	011410206	1,579.99	24	Full Str Trky, M,IC	3-1/2	7 / 4	45	1-3/4	2	14-1/4	1/4



BETTER VALUE AND ADDED VERSATILITY.

Using a shotgun to hunt deer, bear or wild boar is increasing in popularity because improvements in ammunition make modern slug guns more effective at bringing down heavy game. There is also a side benefit to hunting with a Browning shotgun — accessory barrels are available to easily convert that same shotgun into a wingshooter. The cantilever scope mount ensures the scope is still on target when it's time to swap back.



E SILVER RIFLED DEER STALKER



F SILVER RIFLED DEER, MOSSY OAK® BREAK-UP COUNTRY®



G SILVER RIFLED DEER SATIN

E SILVER RIFLED DEER STALKER F SILVER RIFLED DEER, MOSSY OAK BREAK-UP COUNTRY

RECEIVER Aluminum alloy • Semi-humpback design **BARREL** Thick-walled, fully rifled for slug ammunition **ACTION** Gas-operated autoloader • 3" chamber • Active Valve System reliably cycles a wide range of loads **STOCK** Composite • Dura-Touch Armor Coating • Matte black or Mossy Oak® Break-Up Country® camo finish **FEATURES** Cantilever scope mount **IDEAL USAGE** Deer Hunting

G SILVER RIFLED DEER SATIN

RECEIVER Aluminum alloy • Semi-humpback design **BARREL** Thick-walled fully rifled for slug ammunition **ACTION** Gas-operated autoloader • 3" chamber • Active Valve System reliably cycles a wide range of loads **STOCK** Satin finish walnut **FEATURES** Cantilever scope mount (Scope and rings not included) **IDEAL USAGE** Deer Hunting

NEW 2016	GAUGE	CODE NUMBER	SUGGESTED RETAIL	BARREL LENGTH Inches	CHOKES Included	CHAMBER Inches	AVERAGE WEIGHT Lbs./Oz.	OVERALL LENGTH Inches	DROP AT COMB Inches	DROP AT HEEL Inches	LENGTH OF PULL Inches	RATE OF TWIST Inches
SILVER RIFLED DEER STALKER												
E	12	011351321	1,309.99	22	Rif. Bbl./Cant.	3	7 / 12	43	1-3/4	2	14-1/4	28
SILVER RIFLED DEER, MOSSY OAK BREAK-UP COUNTRY												
F	12	011411321	1,459.99	22	Rif. Bbl./Cant.	3	7 / 12	43	1-3/4	2	14-1/4	28
	20	011411621	1,459.99	22	Rif. Bbl./Cant.	3	6 / 12	42-3/4	1-3/4	2-1/4	14-1/4	24
SILVER RIFLED DEER SATIN												
G	20	011371621	1,359.99	22	Rif. Bbl./Cant.	3	6 / 12	42-3/4	1-3/4	2-1/4	14-1/4	24



PUMP-ACTION PERFECTION.

Generally, pump shotguns are entry-level guns built for beginners. We don't see the BPS that way, knowing that many of you demand the highest quality and reliability from a shotgun, whether you are new to the shooting sports or a seasoned gunner. The BPS uses a rugged steel frame and twin action bars for long-lasting, bind-free slide-action performance.

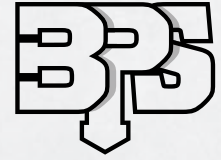

BPS FEATURES AND BENEFITS



BOTTOM EJECTION AND LOADING

- Unique bottom ejection throws empty hulls straight down, out of the line of sight.
- The BPS is the best pump shotgun choice for both right- and left-handed shooters.

MAGAZINE CAPACITY

- 2-3/4": Four in the magazine, one in the chamber.
- 3": Three in the magazine, one in the chamber.
- 3-1/2": Three in the magazine, one in the chamber.
- A three-shot magazine adaptor plug is included.



RELIABLE PUMP-ACTION

- The proven pump-action features rugged steel components.
- The receiver is machined from a solid block of forged steel.
- Rigid double slide bars are made from heat-treated steel to eliminate twisting and binding for faster, more efficient slide-action operation.
- Reliable in all conditions.
- A convenient serrated slide release is located at the rear of the trigger guard.



MAXIMUM GRIP

- Camo composite BPS models combine in-molded checkered gripping surfaces and our proven Dura-Touch Armor Coating for a sure hold and a sleek feel in all climate conditions.



TANG SAFETY

- The thumb-operated, top-tang safety on the BPS can easily be operated with the right or left hand, even with gloves on.

ALL BROWNING FIREARMS ARE SHIPPED WITH A FREE LOCKING DEVICE TO ASSIST IN THE SAFE STORAGE OF FIREARMS.



A BPS HUNTER

INVECTOR-PlusSM STANDARD INVECTORSM BACKBORED TECHNOLOGY

RECEIVER Forged and machined steel • High polish blued finish **BARREL** Ventilated rib **ACTION** Bottom ejection • Dual steel action bars • Top-tang safety **STOCK** Satin finish walnut **FEATURES** Three Invector-Plus choke tubes with 12 and 20 • Three Standard Invector choke tubes with 16, 28 and .410 • Recoil pad on 12 gauge model • Silver colored front bead sight **IDEAL USAGE** Hunting/Sporting Clays

	NEW 2016	GAUGE/BORE	CODE NUMBER	SUGGESTED RETAIL	BARREL LENGTH Inches	CHOKES Included	CHAMBER Inches	AVERAGE WEIGHT lbs./oz.	OVERALL LENGTH Inches	DROP AT COMB Inches	DROP AT HEEL Inches	LENGTH OF PULL Inches	RIB WIDTH Inches
BPS HUNTER													
A	12	012211304	699.99	28	F,M,I,C	3	7 / 11	48-3/4	1-5/8	1-7/8	14-1/4	5/16	
	12	012211305	699.99	26	F,M,I,C	3	7 / 10	46-3/4	1-5/8	1-7/8	14-1/4	5/16	
	16	012211513	729.99	28	F,M,I,C	2-3/4	7 / 2	48-3/4	1-5/8	1-7/8	14-1/4	5/16	
	16	012211514	729.99	26	F,M,I,C	2-3/4	7 / 1	46-3/4	1-5/8	1-7/8	14-1/4	5/16	
	20	012211604	699.99	28	F,M,I,C	3	7 / 1	48-3/4	1-5/8	1-7/8	14-1/4	5/16	
	20	012211605	699.99	26	F,M,I,C	3	7 / 0	46-3/4	1-5/8	1-7/8	14-1/4	5/16	
	28	012211813	729.99	28	F,M,I,C	2-3/4	7 / 0	48-3/4	1-5/8	1-7/8	14-1/4	5/16	
	28	012211814	729.99	26	F,M,I,C	2-3/4	6 / 15	46-3/4	1-5/8	1-7/8	14-1/4	5/16	
	.410	012211914	729.99	26	F,M,I,C	3	7 / 0	46-3/4	1-5/8	1-7/8	14-1/4	5/16	



B BPS MICRO MIDAS

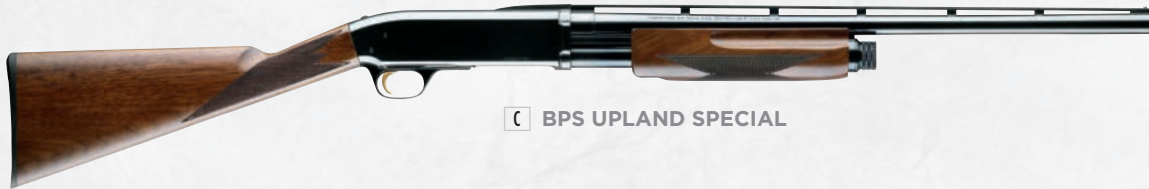

C BPS UPLAND SPECIAL



D BPS TRAP



E BPS MICRO TRAP

B BPS MICRO MIDAS

RECEIVER Forged and machined steel • High polish blued finish **BARREL** Ventilated rib **ACTION** Bottom ejection • Dual steel action bars • Top-tang safety **STOCK** Satin finish walnut • Compact 13" length of pull • Scaled down to comfortably fit smaller shooters **FEATURES** Three Invector-Plus choke tubes with 12 and 20 • Three Standard Invector choke tubes with .410 • Inflex recoil pad • Two 1/4" stock spacers • Silver colored front bead sight **IDEAL USAGE** Hunting/Sporting Clays **ELIGIBLE FOR THE GROWTH INSURANCE PROGRAM** See page 4 for details

C BPS UPLAND SPECIAL

RECEIVER Forged and machined steel • High polish blued finish **BARREL** Ventilated rib **ACTION** Bottom ejection • Dual steel action bars • Top-tang safety **STOCK** Satin finish walnut • English-style straight grip **FEATURES** Three Invector-Plus choke tubes with 12 and 20 • Three Standard Invector with 16 • Silver colored front bead sight **IDEAL USAGE** Hunting/Sporting Clays

D BPS TRAP **E BPS MICRO TRAP**

RECEIVER Engraved • Forged and machined steel • High polish blued finish **BARREL** Ventilated rib **ACTION** Bottom ejection • Dual steel action bars • Top-tang safety **STOCK** Satin finish walnut • Raised comb **FEATURES** Magazine cut-off • Three Invector-Plus choke tubes • HiViz® Pro-Comp fiber-optic sight • Mid-bead sight **IDEAL USAGE** Trap **MICRO TRAP IS ELIGIBLE FOR THE GROWTH INSURANCE PROGRAM** See page 4 for details

	NEW 2016	GAUGE/BORE	CODE NUMBER	SUGGESTED RETAIL	BARREL LENGTH Inches	CHOICES Included	CHAMBER Inches	AVERAGE WEIGHT Lbs. / Oz.	OVERALL LENGTH Inches	DROP AT COMB Inches	DROP AT HEEL Inches	LENGTH OF PULL Inches	RIB WIDTH Inches
BPS MICRO MIDAS													
		12	012270305	699.99	26	F,M,IC	3	7 / 10	45-3/4	1-5/8	1-5/8	13	5/16
B		12	012270306	699.99	24	F,M,IC	3	7 / 9	43-3/4	1-5/8	1-5/8	13	5/16
		12	012270307	699.99	22	F,M,IC	3	7 / 8	41-3/4	1-5/8	1-5/8	13	5/16
		20	012270605	699.99	26	F,M,IC	3	7 / 1	45-3/4	1-5/8	1-5/8	13	5/16
		20	012270606	699.99	24	F,M,IC	3	7 / 0	43-3/4	1-5/8	1-5/8	13	5/16
		20	012270607	699.99	22	F,M,IC	3	6 / 15	41-3/4	1-5/8	1-5/8	13	5/16
		.410	012270914	729.99	26	F,M,IC	3	7 / 0	45-3/4	1-5/8	1-5/8	13	5/16
		.410	012270915	729.99	24	F,M,IC	3	6 / 15	43-3/4	1-5/8	1-5/8	13	5/16
BPS UPLAND SPECIAL													
		12	012216307	699.99	22	F,M,IC	3	7 / 8	42-1/2	1-5/8	1-7/8	14	5/16
		16	012216514	729.99	26	F,M,IC	2-3/4	6 / 13	46-1/2	1-5/8	1-7/8	14	5/16
		16	012216515	729.99	24	F,M,IC	2-3/4	6 / 12	44-1/2	1-5/8	1-7/8	14	5/16
C		20	012216607	699.99	22	F,M,IC	3	6 / 11	42-1/2	1-5/8	1-7/8	14	5/16
BPS TRAP													
D		12	012242403	839.99	30	F,IM,M	2-3/4	8 / 6	51	1-3/8	2	14-3/8	5/16
BPS MICRO TRAP													
E		12	012241404	839.99	28	F,IM,M	2-3/4	8 / 1	48-1/4	1-3/8	2	13-3/4	5/16



A BPS STALKER



B BPS, MOSSY OAK® SHADOW GRASS BLADES

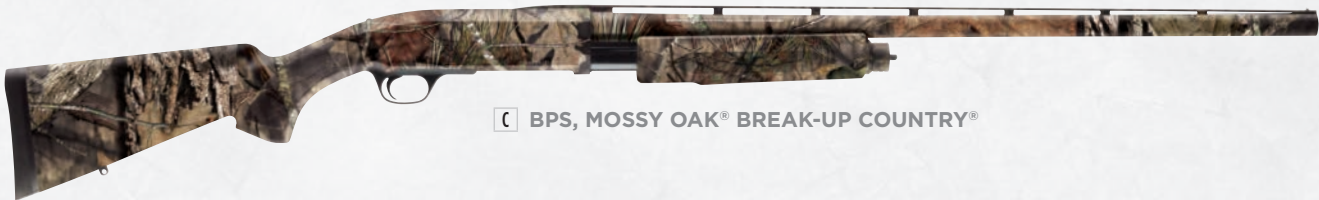

C BPS, MOSSY OAK® BREAK-UP COUNTRY®



D BPS NWTF®, MOSSY OAK® BREAK-UP COUNTRY®

A BPS STALKER B BPS, MOSSY OAK SHADOW GRASS BLADES C BPS, MOSSY OAK BREAK-UP COUNTRY

RECEIVER Forged and machined steel **BARREL** Ventilated rib **ACTION** Bottom ejection • Dual steel action bars • Top-tang safety **STOCK** Composite • Matte black or Mossy Oak® camo finishes
FEATURES Three Invector-Plus choke tubes • Silver colored front bead sight **IDEAL USAGE** Hunting/Sporting Clays

D BPS NWTF, MOSSY OAK BREAK-UP COUNTRY

RECEIVER Forged and machined steel • Drilled and tapped for scope mounts **BARREL** Ventilated rib **ACTION** Bottom ejection • Dual steel action bars • Top-tang safety **STOCK** Composite • Dura-Touch Armor Coating • Mossy Oak® Break-Up Country® camo finish **FEATURES** Three Invector-Plus choke tubes • HiViz® 4-in-1 fiber-optic sight • NWTF® buttstock decal **IDEAL USAGE** Hunting/Turkey Hunting

	NEW 2016 GAUGE	CODE NUMBER	SUGGESTED RETAIL	BARREL LENGTH Inches	CHOKES Included	CHAMBER Inches	AVERAGE WEIGHT Lbs. / Oz.	OVERALL LENGTH Inches	DROP AT COMB Inches	DROP AT HEEL Inches	LENGTH OF PULL Inches	RIB WIDTH Inches
BPS STALKER												
	12	012212204	799.99	28	F,M,IC	3-1/2	8 / 5	49-1/4	1-1/2	2-1/2	14-1/4	5/16
	12	012212205	799.99	26	F,M,IC	3-1/2	8 / 4	47-1/4	1-1/2	2-1/2	14-1/4	5/16
A	12	012212303	699.99	30	F,M,IC	3	8 / 2	50-3/4	1-1/2	2-1/2	14-1/4	5/16
	12	012212304	699.99	28	F,M,IC	3	8 / 1	48-3/4	1-1/2	2-1/2	14-1/4	5/16
	12	012212305	699.99	26	F,M,IC	3	8 / 0	46-3/4	1-1/2	2-1/2	14-1/4	5/16
BPS, MOSSY OAK SHADOW GRASS BLADES												
	12	012271204	949.99	28	F,M,IC	3-1/2	8 / 5	49-1/4	1-1/2	2-1/2	14-1/4	5/16
	12	012271205	949.99	26	F,M,IC	3-1/2	8 / 4	47-1/4	1-1/2	2-1/2	14-1/4	5/16
B	12	012271304	819.99	28	F,M,IC	3	8 / 1	48-3/4	1-1/2	2-1/2	14-1/4	5/16
	12	012271305	819.99	26	F,M,IC	3	8 / 0	46-3/4	1-1/2	2-1/2	14-1/4	5/16
BPS, MOSSY OAK BREAK-UP COUNTRY												
C	12	012279204	949.99	28	F,M,IC	3-1/2	8 / 5	49-1/4	1-1/2	2-1/2	14-1/4	5/16
	12	012279205	949.99	26	F,M,IC	3-1/2	8 / 4	47-1/4	1-1/2	2-1/2	14-1/4	5/16
	12	012279304	819.99	28	F,M,IC	3	8 / 1	48-3/4	1-1/2	2-1/2	14-1/4	5/16
	12	012279305	819.99	26	F,M,IC	3	8 / 0	46-3/4	1-1/2	2-1/2	14-1/4	5/16
BPS NWTF, MOSSY OAK BREAK-UP COUNTRY												
	12	012280206	1,029.99	24	XF Trky,M,IC	3-1/2	8 / 3	45-1/4	1-1/2	2-1/2	14-1/4	5/16
D	12	012280306	949.99	24	XF Trky,M,IC	3	7 / 15	44-3/4	1-1/2	2-1/2	14-1/4	5/16



WHAT'S YOUR GAME?

Don't confine a shotgun like the BPS to just wingshooting. With the addition of an extra barrel, the versatile and incredibly durable pump-action BPS is ideally suited to every type of hunting and shooting sport, from dropping deer to dusting clays.

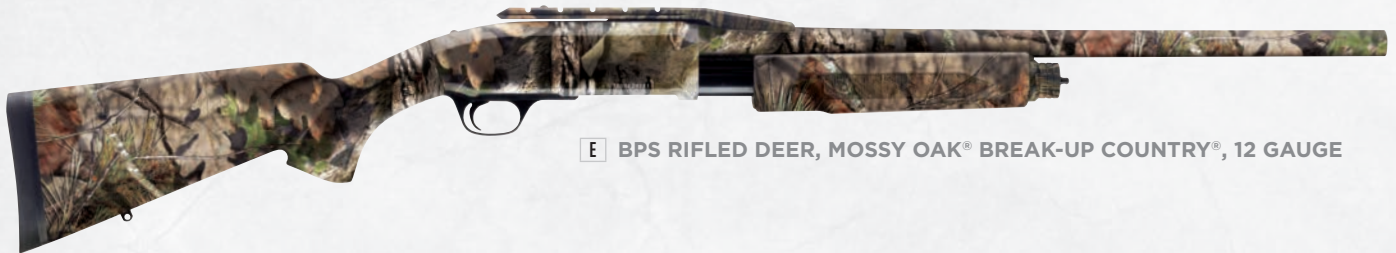

E BPS RIFLED DEER, MOSSY OAK® BREAK-UP COUNTRY®, 12 GAUGE



F BPS RIFLED DEER, MOSSY OAK® BREAK-UP COUNTRY®, 20 GAUGE



G BPS RIFLED DEER HUNTER

E BPS RIFLED DEER, MOSSY OAK BREAK-UP COUNTRY, 12 GA.

F BPS RIFLED DEER, MOSSY OAK BREAK-UP COUNTRY, 20 GA.

RECEIVER Forged and machined steel **BARREL** Thick-walled for slug and sabot ammunition • Rifled 12 gauge: 1 in 28", 20 gauge: 1 in 35 twist **ACTION** Bottom ejection • Dual steel action bars • Top-tang safety **STOCK** 12 gauge: Composite • 20 gauge: Walnut • Dura-Touch Armor Coating • Mossy Oak® Break-Up Country® camo finish **FEATURES** Cantilever scope mount

IDEAL USAGE Deer Hunting

G BPS RIFLED DEER HUNTER

RECEIVER Forged and machined steel **BARREL** Thick-walled for slug and sabot ammunition • Rifled, 12 gauge: 1 in 28" twist, 20 gauge: 1 in 35" twist **ACTION** Bottom ejection • Dual steel action bars • Top-tang safety **STOCK** Satin finish walnut **FEATURES** Cantilever scope mount **IDEAL USAGE** Deer Hunting

NEW 2016	GAUGE	CODE NUMBER	SUGGESTED RETAIL	BARREL LENGTH Inches	CHOKES Included	CHAMBER Inches	AVERAGE WEIGHT LBS. / OZ.	OVERALL LENGTH Inches	DROP AT COMB Inches	DROP AT HEEL Inches	LENGTH OF PULL Inches	RATE OF TWIST Inches
BPS RIFLED DEER, MOSSY OAK BREAK-UP COUNTRY, 12 GAUGE												
E	12	012281324	869.99	22	Rif. Bbl./Cant.	3	7 / 10	42-1/2	1-1/2	2-1/2	14-1/4	28
BPS RIFLED DEER, MOSSY OAK BREAK-UP COUNTRY, 20 GAUGE												
F	20	012281624	979.99	22	Rif. Bbl./Cant.	3	7 / 5	42-1/4	1-5/8	1-7/8	14	35
BPS RIFLED DEER HUNTER												
G	12	012214324	829.99	22	Rif. Bbl./Cant.	3	7 / 10	42-1/4	1-1/2	1-5/8	14	28
	20	012214624	839.99	22	Rif. Bbl./Cant.	3	7 / 4	42-1/4	1-5/8	1-5/8	14	35



A BIG BORE FOR BIG BIRDS.

Hard-hitting and potent, the 10 gauge is always a force to be reckoned with. When your quarry consists of geese and turkey, there is no substitute for a hefty shot payload.



A GOLD LIGHT 10 GAUGE



B BPS 10 GAUGE



C NWTf® BPS 10 GAUGE, MOSSY OAK® BREAK-UP COUNTRY®

A GOLD LIGHT 10 GAUGE

RECEIVER Aluminum alloy **BARREL** Ventilated rib **ACTION** Gas-operated autoloader • 3-1/2" chamber • Magazine capacity - Four in the magazine plus one in the chamber **STOCK** Composite • Dura-Touch Armor Coating • Mossy Oak® camo finishes **FEATURES** Three Standard Invector choke tubes • National Wild Turkey Federation model includes HiViz® 4-in-1 fiber-optic sight and NWTf® logo on the buttstock • Receiver is drilled and tapped for scope mount **IDEAL USAGE** Waterfowl/Turkey

B BPS 10 GAUGE

RECEIVER Forged and machined steel **BARREL** Ventilated rib **ACTION** Bottom ejection • Dual steel action bars • 3-1/2" chamber • Top-tang safety • Magazine capacity - Four in the magazine plus one in the chamber **STOCK** Composite • Dura-Touch Armor Coating • Mossy Oak® camo finishes • Matte black on Stalker **FEATURES** Three Standard Invector choke tubes • Brass front bead sight **IDEAL USAGE** Waterfowl

C NWTf BPS 10 GAUGE, MOSSY OAK BREAK-UP COUNTRY

RECEIVER Forged and machined steel • Drilled and tapped for scope mounts **BARREL** Ventilated rib • 24" length **ACTION** Bottom ejection • Dual steel action bars • 3-1/2" chamber • Top-tang safety • Magazine capacity - Four in the magazine plus one in the chamber **STOCK** Composite • Dura-Touch Armor Coating • Mossy Oak® Break-Up Country® camo finish • NWTf® logo on the buttstock **FEATURES** Standard Invector X-Full Turkey choke tube • HiViz® 4-in-1 fiber-optic sight • Endorsed by the National Wild Turkey Federation **IDEAL USAGE** Turkey

NEW 2016	MODEL	GAUGE	CODE NUMBER	SUGGESTED RETAIL	BARREL LENGTH Inches	CHOKES Included	CHAMBER Inches	AVERAGE WEIGHT lbs./oz.	OVERALL LENGTH Inches	DROP AT COMB Inches	DROP AT HEEL Inches	LENGTH OF PULL Inches	RIB WIDTH Inches
GOLD LIGHT 10 GAUGE (SHOWN IN MOSSY OAK BREAK-UP COUNTRY)													
A	MOBUC	10	011289113	1,739.99	28	F,M,IC	3-1/2	9 / 10	50	1-1/2	2-1/2	14-1/2	5/16
	MOBUC	10	011289114	1,739.99	26	F,M,IC	3-1/2	9 / 9	48	1-1/2	2-1/2	14-1/2	5/16
	NWTf/MOBUC	10	011288115	1,869.99	24	XF Turkey	3-1/2	9 / 4	46	1-1/2	2-1/2	14-1/2	5/16
	MOSGB	10	011287113	1,739.99	28	F,M,IC	3-1/2	9 / 10	50	1-1/2	2-1/2	14-1/2	5/16
	MOSGB	10	011287114	1,739.99	26	F,M,IC	3-1/2	9 / 9	48	1-1/2	2-1/2	14-1/2	5/16
BPS 10 GAUGE (SHOWN IN MOSSY OAK SHADOW GRASS BLADES)													
	Stalker	10	012212113	799.99	28	F,M,IC	3-1/2	10 / 9	50	1-1/2	2-1/2	14-1/4	5/16
	Stalker	10	012212114	799.99	26	F,M,IC	3-1/2	10 / 8	48	1-1/2	2-1/2	14-1/4	5/16
	MOBUC	10	012279113	949.99	28	F,M,IC	3-1/2	10 / 9	50	1-1/2	2-1/2	14-1/4	5/16
	MOBUC	10	012279114	949.99	26	F,M,IC	3-1/2	10 / 8	48	1-1/2	2-1/2	14-1/4	5/16
B	MOSGB	10	012271113	949.99	28	F,M,IC	3-1/2	10 / 9	50	1-1/2	2-1/2	14-1/4	5/16
	MOSGB	10	012271114	949.99	26	F,M,IC	3-1/2	10 / 8	48	1-1/2	2-1/2	14-1/4	5/16
NWTf BPS 10 GAUGE, MOSSY OAK BREAK-UP COUNTRY													
C	MOBUC	10	012280115	1,029.99	24	XF Turkey	3-1/2	10 / 3	46	1-1/2	2-1/2	14-1/4	5/16







**A BROWNING RIFLE
IS A SURE SHOT.**

Bolt-action, autoloader, lever-action — there are many types of sporting rifles on the market and each has a loyal following. While the style of rifle may vary, the one thing every rifle must be is accurate. That's when it helps to have the name Browning on the barrel. From the rifle that started it all, the Model 1885, to our current crop of X-Bolts, Browning is synonymous with accurate, innovative rifles of the highest quality.

RIFLES



A RIFLE FOR TOUGH COUNTRY.

Even if you have never been to a place called Hell's Canyon, you can imagine what it might look like. It will most likely have steep walls, sharp rocks and thick, thorny brush — just the sort of place the big bucks like to hide. If you're lucky enough to catch a glimpse of the deer of your dreams, you may only have one shot, make it count with a Browning X-Bolt. This new Hell's Canyon Speed edition rifle is tougher than hell itself with a composite stock finished in A-TACS AU Camo™ and a Cerakote™ Burnt Bronze finish on the barrel and action to provide versatile concealment and protection.

X-BOLT



**NEW
2016**



X-BOLT FEATURES AND BENEFITS

FEATHERTRIGGER™

FEATHER TRIGGER

- For precise shooting there is absolutely no substitute for a crisp, predictable trigger.
- The X-Bolt's three-lever Feather Trigger provides a clean, crisp pull with no take-up or creep and minimal overtravel.
- The trigger is screw adjustable from 3 to 5 lbs. and factory pre-set at approximately 3-1/2 - 4 lbs.
- An alloy trigger housing contains hard chromed steel components that are highly polished on all critical contact surfaces.

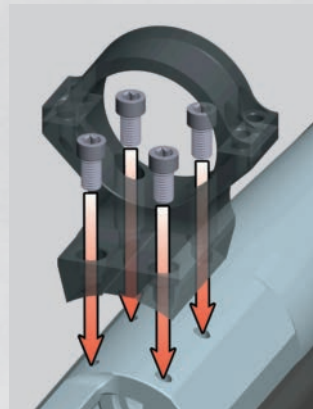

X-LOCK SCOPE MOUNTING SYSTEM

- Securely mounted optics are essential for accuracy and precision on any rifle.
- X-Lock mounts feature a four screws per base design that replaces the traditional two screw system.
- Offers more accurate placement and more secure attachment to the receiver.



FREE-FLOATING BARREL

- Every X-Bolt is individually bedded into the stock for a true free-floating barrel, not bedded using a master receiver like the competition.
- The X-Bolt barrel is free-floated by bedding the front and rear of the action for stability.
- Maintains barrel to stock spacing for consistent accuracy.
- The recessed muzzle crown helps protect the rifling from damage.
- Barrels are triple checked for interior finish, straightness and air-gauged for uniformity.
- Hand-reamed chamber for precision accuracy.



BOLT UNLOCK BUTTON

- The bolt unlock button works in conjunction with the top-tang safety to provide an extra margin of safety when checking and unloading the chamber.
- Located on top of the bolt handle, the bolt unlock button allows the bolt to be unlocked and opened with the tang safety in the on safe position.
- The convenient tang safety blocks the trigger sear and features a firing pin block for added security.

ALL BROWNING FIREARMS ARE SHIPPED WITH A FREE LOCKING DEVICE TO ASSIST IN THE SAFE STORAGE OF FIREARMS.



A-TACS AU CAMO.

The new X-Bolt Hell's Canyon Speed features A-TACS AU (Arid/Urban) Camo pattern to help hide you from an animal's keen eyes. A-TACS (Advanced Tactical Concealment System) engineers camouflage patterns that blend into the widest possible range of environments. Unlike popular "leaf and twig" camo patterns that use realistic parts of nature to blend in with specific backgrounds, A-TACS relies on a patented process to build a composite from natural colors that have been digitally sampled from real-world elements. These "micro" patterns form larger, more distinct "macro" patterns, with no horizontal or vertical orientation, and conceal more effectively at a distance. This "pattern within a pattern" concept allows A-TACS to eliminate unnatural outlines when viewed from afar. A-TACS camo also benefits from a greater range of intermingled natural colors that are blended and overlaid into one another to create a more naturalistic appearance.



A-TACS AU Camo



Barrel Fluting



Cerakote Burnt Bronze Finish

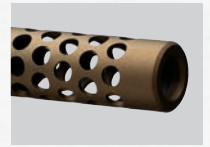

Muzzle Brake and Thread Protector

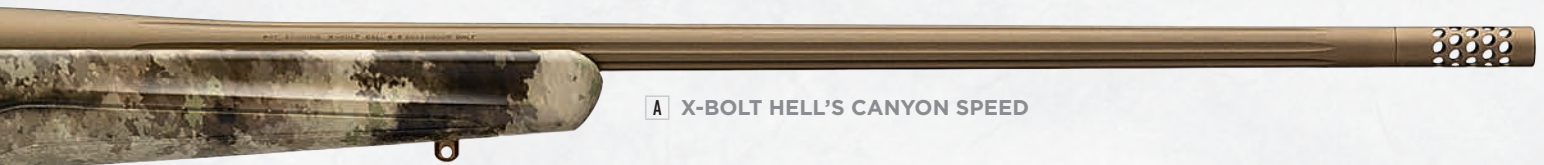

A X-BOLT HELL'S CANYON SPEED

RECEIVER Steel • Cerakote Burnt Bronze finish • Glass bedded • Drilled and tapped for scope mounts **BARREL** Threaded muzzle brake (thread protector included) • Cerakote Burnt Bronze finish • Fluted • Free-floating • Hand chambered • Target crown **ACTION** Bolt-action • 60° bolt lift • Adjustable Feather Trigger • Detachable rotary magazine • Top-tang safety • Bolt unlock button **STOCK** Composite • Textured gripping surfaces • Palm swell • A-TACS AU camo • Dura-Touch Armor Coating **FEATURES** Sling swivel studs • Inflex recoil pad (Scope and mounts not included)

NEW 2016	CALIBER	CODE NUMBER	SUGGESTED RETAIL	ACTION S / Super Short S / Short L / Long	BARREL LENGTH Inches	TOTAL CAPACITY Includes one in the chamber	AVERAGE WEIGHT lbs./Oz.	OVERALL LENGTH Inches - muzzle brake removed	DROP AT COMB Inches	DROP AT HEEL Inches	LENGTH OF PULL Inches	RATE OF TWIST Inches
X-BOLT HELL'S CANYON SPEED												
	• 243 Win.	035379211	1,199.99	S	22	5	6 / 5	42	11/16	1/2	13-5/8	10
A	• 6.5 Creedmoor	035379282	1,199.99	S	22	5	6 / 5	42	11/16	1/2	13-5/8	8
	• 308 Win.	035379218	1,199.99	S	22	5	6 / 5	42	11/16	1/2	13-5/8	12
	• 7mm-08 Rem.	035379216	1,199.99	S	22	5	6 / 5	42	11/16	1/2	13-5/8	9-1/2
	• 270 WSM	035379248	1,239.99	S	23	4	6 / 8	43	11/16	1/2	13-5/8	10
	• 300 WSM	035379246	1,239.99	S	23	4	6 / 8	43	11/16	1/2	13-5/8	10
	• 26 Nosler	035379287	1,239.99	L	26	3	6 / 13	46-3/4	11/16	1/2	13-5/8	8
	• 270 Win.	035379224	1,199.99	L	22	5	6 / 9	42-3/4	11/16	1/2	13-5/8	10
	• 30-06 Sprg.	035379226	1,199.99	L	22	5	6 / 9	42-3/4	11/16	1/2	13-5/8	10
	• 7mm Rem. Mag.	035379227	1,239.99	L	26	4	6 / 13	46-3/4	11/16	1/2	13-5/8	9-1/2
	• 300 Win. Mag.	035379229	1,239.99	L	26	4	6 / 13	46-3/4	11/16	1/2	13-5/8	10

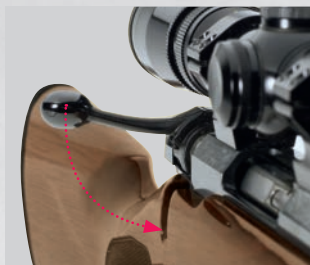

60° BOLT LIFT

- Short 60° bolt lift is fast cycling and the hand easily clears the scope.
- The bolt is machined from solid steel bar stock for strength and custom rifle precision.
- Three locking lugs provide exceptional bolt strength.



ROTARY MAGAZINE

- The unique rotary magazine is removable, durable, easy to load and feeds rounds from the center line, not off to the side like other rifles, for straight to the chamber feeds.
- Unique design holds U.S. patent numbers: 8,156,675; 8,484,875 and 8,745,912



TANG SAFETY

- Tang safety is easy to reach with the thumb.

PERSONALIZED ENGRAVING

- The bolt can be personalized with your name. Call (800) 333-3288.



Block



Script





BEYOND
—THE HUNT—

JULIE KREUTER

Join avid huntress Julie Kreuter and her husband Rick as they team up to bring you the big picture of hunting in their exciting series *Beyond the Hunt* on the Outdoor Channel. You can get to know more about this dynamic duo on page 310.

THE WARMTH OF WALNUT.

Browning guns are prized for finely crafted and finished wood. Though a composite stock has its advantages, there will always be those among you who prefer the warmth and feel of walnut. We offer several X-Bolt models with wood stocks, each bedded at the recoil lug and rear action screw to help ensure accuracy.



A X-BOLT HUNTER



B X-BOLT MICRO MIDAS

A X-BOLT HUNTER

RECEIVER Steel • Matte blued finish • Glass bedded • Drilled and tapped for scope mounts **BARREL** Matte blued finish • Free-floating • Hand chambered • Target crown **ACTION** Bolt-action • 60° bolt lift • Adjustable Feather Trigger • Detachable rotary magazine • Top-tang safety • Bolt unlock button **STOCK** Satin finish checkered walnut **FEATURES** Sling swivel studs • Inflex recoil pad • 375 H&H Mag. includes open sights with 18" sight radius (Scope and mounts not included)

B X-BOLT MICRO MIDAS

RECEIVER Steel • Matte blued finish • Glass bedded • Drilled and tapped for scope mounts **BARREL** Matte blued finish • Free-floating • Hand chambered • Target crown **ACTION** Bolt-action • 60° bolt lift • Adjustable Feather Trigger • Detachable rotary magazine • Top-tang safety • Bolt unlock button **STOCK** Satin finish checkered walnut **FEATURES** Sling swivel studs • Inflex recoil pad • Three 1/4" stock spacers **ELIGIBLE FOR THE GROWTH INSURANCE PROGRAM** See page 4 for details

NEW 2016	CALIBER	RIGHT-HAND MODELS		LEFT-HAND MODELS		ACTION SS / Super Short S / Short, L / Long	BARREL LENGTH Inches	TOTAL CAPACITY Includes one in the chamber	AVERAGE WEIGHT Lbs. / Oz.	OVERALL LENGTH Inches	DROP AT COMB Inches	DROP AT HEEL Inches	LENGTH OF PULL Inches	RATE OF TWIST Inches
		CODE NUMBER	SUGGESTED RETAIL	NEW 2016 CODE NUMBER	SUGGESTED RETAIL									
X-BOLT HUNTER														
	223 Rem.	035342208	899.99	035343208	939.99	SS	22	6	6 / 6	41-1/2	11/16	1/2	13-5/8	8
	22-250 Rem.	035342209	899.99	035343209	939.99	SS	22	5	6 / 6	41-1/2	11/16	1/2	13-5/8	9
	243 Win.	035208211	899.99	035255211	939.99	S	22	5	6 / 8	42	11/16	1/2	13-5/8	10
	7mm-08 Rem.	035208216	899.99	035255216	939.99	S	22	5	6 / 8	42	11/16	1/2	13-5/8	9-1/2
	308 Win.	035208218	899.99	035255218	939.99	S	22	5	6 / 8	42	11/16	1/2	13-5/8	12
	270 WSM	035208248	949.99	035255248	979.99	S	23	4	6 / 11	43	11/16	1/2	13-5/8	10
A	300 WSM	035208246	949.99	035255246	979.99	S	23	4	6 / 11	43	11/16	1/2	13-5/8	10
	325 WSM	035208277	949.99	—	—	S	23	4	6 / 11	43	11/16	1/2	13-5/8	10
	25-06 Rem.	035208223	899.99	035255223	939.99	L	24	5	6 / 14	44-3/4	11/16	1/2	13-5/8	10
	270 Win.	035208224	899.99	035255224	939.99	L	22	5	6 / 12	42-3/4	11/16	1/2	13-5/8	10
	280 Rem.	035208225	899.99	—	—	L	22	5	6 / 12	42-3/4	11/16	1/2	13-5/8	10
	30-06 Sprg.	035208226	899.99	035255226	939.99	L	22	5	6 / 12	42-3/4	11/16	1/2	13-5/8	10
	7mm Rem. Mag.	035208227	949.99	035255227	979.99	L	26	4	7 / 0	46-3/4	11/16	1/2	13-5/8	9-1/2
	300 Win. Mag.	035208229	949.99	035255229	979.99	L	26	4	7 / 0	46-3/4	11/16	1/2	13-5/8	10
	338 Win. Mag.	035208231	949.99	—	—	L	26	4	7 / 0	46-3/4	11/16	1/2	13-5/8	10
	375 H&H Mag.	035208132	949.99	—	—	L	24	4	7 / 0	44-3/4	11/16	1/2	13-5/8	12
X-BOLT MICRO MIDAS														
	22-250 Rem.	035346209	859.99	—	—	SS	20	5	6 / 1	38-3/8	11/16	1/2	12-1/2	9
B	243 Win.	035248211	859.99	035279211	899.99	S	20	5	6 / 1	38-7/8	11/16	1/2	12-1/2	10
	7mm-08 Rem.	035248216	859.99	035279216	899.99	S	20	5	6 / 1	38-7/8	11/16	1/2	12-1/2	9-1/2
	308 Win.	035248218	859.99	035279218	899.99	S	20	5	6 / 1	38-7/8	11/16	1/2	12-1/2	12
	270 WSM	035248248	899.99	—	—	S	22	4	6 / 6	40-7/8	11/16	1/2	12-1/2	10
	300 WSM	035248246	899.99	—	—	S	22	4	6 / 6	40-7/8	11/16	1/2	12-1/2	10





C X-BOLT COMPOSITE STALKER



D X-BOLT STAINLESS STALKER

C X-BOLT COMPOSITE STALKER D X-BOLT STAINLESS STALKER

RECEIVER Steel or stainless steel • Matte blued or stainless finish • Glass bedded • Drilled and tapped for scope mounts **BARREL** Matte blued or stainless finish • Free-floating • Hand chambered • Target crown **ACTION** Bolt-action • 60° bolt lift • Adjustable Feather Trigger • Detachable rotary magazine • Top-tang safety • Bolt unlock button **STOCK** Composite • Textured gripping surfaces • Palm swell • Matte black • Dura-Touch Armor Coating **FEATURES** Sling swivel studs • Inflex recoil pad • 375 H&H Mag. includes open sights with 18" sight radius (Scope and mounts not included)

NEW 2016	CALIBER	CODE NUMBER	SUGGESTED RETAIL	ACTION SS / Super Short S / Short L / Long	BARREL LENGTH Inches	TOTAL CAPACITY Includes one in the chamber	AVERAGE WEIGHT Lbs. / Oz.	OVERALL LENGTH Inches	DROP AT COMB Inches	DROP AT HEEL Inches	LENGTH OF PULL Inches	RATE OF TWIST Inches
X-BOLT COMPOSITE STALKER												
	223 Rem.	035335208	859.99	SS	22	6	6 / 5	41-1/2	11/16	1/2	13-5/8	8
	22/250 Rem.	035335209	859.99	SS	22	5	6 / 5	41-1/2	11/16	1/2	13-5/8	9
C	243 Win.	035201211	859.99	S	22	5	6 / 5	42	11/16	1/2	13-5/8	10
	6.5 Creedmoor	035201282	859.99	S	22	5	6 / 5	42	11/16	1/2	13-5/8	8
	7mm-08 Rem.	035201216	859.99	S	22	5	6 / 5	42	11/16	1/2	13-5/8	9-1/2
	308 Win.	035201218	859.99	S	22	5	6 / 5	42	11/16	1/2	13-5/8	12
	270 WSM	035201248	899.99	S	23	4	6 / 8	43	11/16	1/2	13-5/8	10
	300 WSM	035201246	899.99	S	23	4	6 / 8	43	11/16	1/2	13-5/8	10
	25-06 Rem.	035201223	859.99	L	24	5	6 / 11	44-3/4	11/16	1/2	13-5/8	10
	270 Win.	035201224	859.99	L	22	5	6 / 9	42-3/4	11/16	1/2	13-5/8	10
	280 Rem.	035201225	859.99	L	22	5	6 / 9	42-3/4	11/16	1/2	13-5/8	10
	30-06 Sprg.	035201226	859.99	L	22	5	6 / 9	42-3/4	11/16	1/2	13-5/8	10
	7mm Rem. Mag.	035201227	899.99	L	26	4	6 / 13	46-3/4	11/16	1/2	13-5/8	9-1/2
	300 Win. Mag.	035201229	899.99	L	26	4	6 / 13	46-3/4	11/16	1/2	13-5/8	10
	338 Win. Mag.	035201231	899.99	L	26	4	6 / 13	46-3/4	11/16	1/2	13-5/8	10
X-BOLT STAINLESS STALKER												
	223 Rem.	035336208	1,139.99	SS	22	6	6 / 5	41-1/2	11/16	1/2	13-5/8	8
	22/250 Rem.	035336209	1,139.99	SS	22	5	6 / 5	41-1/2	11/16	1/2	13-5/8	9
D	243 Win.	035202211	1,139.99	S	22	5	6 / 5	42	11/16	1/2	13-5/8	10
	6.5 Creedmoor	035202282	1,139.99	S	22	5	6 / 5	42	11/16	1/2	13-5/8	8
	7mm-08 Rem.	035202216	1,139.99	S	22	5	6 / 5	42	11/16	1/2	13-5/8	9-1/2
	308 Win.	035202218	1,139.99	S	22	5	6 / 5	42	11/16	1/2	13-5/8	12
	270 WSM	035202248	1,179.99	S	23	4	6 / 8	43	11/16	1/2	13-5/8	10
	7mm WSM	035202249	1,179.99	S	23	4	6 / 8	43	11/16	1/2	13-5/8	9-1/2
	300 WSM	035202246	1,179.99	S	23	4	6 / 8	43	11/16	1/2	13-5/8	10
	325 WSM	035202277	1,179.99	S	23	4	6 / 8	43	11/16	1/2	13-5/8	10
	25-06 Rem.	035202223	1,139.99	L	24	5	6 / 11	44-3/4	11/16	1/2	13-5/8	10
	270 Win.	035202224	1,139.99	L	22	5	6 / 9	42-3/4	11/16	1/2	13-5/8	10
	280 Rem.	035202225	1,139.99	L	22	5	6 / 9	42-3/4	11/16	1/2	13-5/8	10
	30-06 Sprg.	035202226	1,139.99	L	22	5	6 / 9	42-3/4	11/16	1/2	13-5/8	10
	7mm Rem. Mag.	035202227	1,179.99	L	26	4	6 / 13	46-3/4	11/16	1/2	13-5/8	9-1/2
	300 Win. Mag.	035202229	1,179.99	L	26	4	6 / 13	46-3/4	11/16	1/2	13-5/8	10
	338 Win. Mag.	035202231	1,179.99	L	26	4	6 / 13	46-3/4	11/16	1/2	13-5/8	10
	375 H&H	035202132	1,179.99	L	24	4	6 / 13	44-3/4	11/16	1/2	13-5/8	12





THE
**WESTERN
HUNTER**

CHRIS DENHAM

Trek along with Chris Denham and his compatriots on *The Western Hunter* airing on the Sportsman Channel. Learn more about the show in the bio on page 308.





A X-BOLT MEDALLION



B X-BOLT HIGH GRADE HUNTER, FULL LINE DEALER



C X-BOLT HUNTER, FULL LINE DEALER



A X-BOLT MEDALLION

RECEIVER Steel • Engraved with polished blued finish • Glass bedded • Drilled and tapped for scope mounts **BARREL** Blued finish • Free-floating • Hand chambered • Target crown **ACTION** Bolt-action • 60° bolt lift • Adjustable Feather Trigger • Detachable rotary magazine • Top-tang safety • Bolt unlock button **STOCK** Gloss finish checkered walnut • Rosewood fore-end grip and pistol grip cap **FEATURES** Sling swivel studs • Inflex recoil pad (Scope and mounts not included) • 375 H&H Mag. includes open sights with 18" sight radius

B X-BOLT HIGH GRADE HUNTER, FULL LINE DEALER **C X-BOLT HUNTER, FULL LINE DEALER**

RECEIVER Steel • Matte blued finish • Glass bedded • Drilled and tapped for scope mounts **BARREL** Matte blued finish • Free-floating • Hand chambered • Target crown • Hunter has round barrel • High Grade Hunter has full octagon barrel **ACTION** Bolt-action • 60° bolt lift • Adjustable Feather Trigger • Detachable rotary magazine • Top-tang safety • Bolt unlock button **STOCK** Raised hunter cheekpiece • Hunter has satin finish checkered walnut • High Grade Hunter has oil finish Grade III/IV checkered walnut with rosewood fore-end grip and pistol grip caps **FEATURES** Sling swivel studs • Inflex recoil pad • Available only from Browning Full Line and Medallion Dealers

NEW 2016	CALIBER	RIGHT-HAND MODELS		LEFT-HAND MODELS		ACTION SS / Super Short S / Short, L / Long	BARREL LENGTH Inches	TOTAL CAPACITY Includes one in the chamber	AVERAGE WEIGHT Lbs. / Oz.	OVERALL LENGTH Inches	DROP AT COMB Inches	DROP AT HEEL Inches	LENGTH OF PULL Inches	RATE OF TWIST Inches
		CODE NUMBER	SUGGESTED RETAIL	NEW 2016	CODE NUMBER									
X-BOLT MEDALLION														
	223 Rem.	035344208	1,039.99	—	—	SS	22	6	6 / 6	41-1/2	11/16	1/2	13-5/8	8
	22-250 Rem.	035344209	1,039.99	—	—	SS	22	5	6 / 6	41-1/2	11/16	1/2	13-5/8	9
	243 Win.	035200211	1,039.99	035253211	1,069.99	S	22	5	6 / 8	42	11/16	1/2	13-5/8	10
	308 Win.	035200218	1,039.99	035253218	1,069.99	S	22	5	6 / 8	42	11/16	1/2	13-5/8	12
A	270 WSM	035200248	1,079.99	035253248	1,099.99	S	23	4	6 / 11	43	11/16	1/2	13-5/8	10
	7mm WSM	035200249	1,079.99	—	—	S	23	4	6 / 11	43	11/16	1/2	13-5/8	9-1/2
	300 WSM	035200246	1,079.99	035253246	1,099.99	S	23	4	6 / 11	43	11/16	1/2	13-5/8	10
	325 WSM	035200277	1,079.99	—	—	S	23	4	6 / 11	43	11/16	1/2	13-5/8	10
	25-06 Rem.	035200223	1,039.99	—	—	L	24	5	6 / 14	44-3/4	11/16	1/2	13-5/8	10
	270 Win.	035200224	1,039.99	035253224	1,069.99	L	22	5	6 / 12	42-3/4	11/16	1/2	13-5/8	10
	280 Rem.	035200225	1,039.99	—	—	L	22	5	6 / 12	42-3/4	11/16	1/2	13-5/8	10
	30-06 Sprg.	035200226	1,039.99	035253226	1,069.99	L	22	5	6 / 12	42-3/4	11/16	1/2	13-5/8	10
	7mm Rem. Mag.	035200227	1,079.99	035253227	1,099.99	L	26	4	7 / 0	46-3/4	11/16	1/2	13-5/8	9-1/2
	300 Win. Mag.	035200229	1,079.99	035253229	1,099.99	L	26	4	7 / 0	46-3/4	11/16	1/2	13-5/8	10
	338 Win. Mag.	035200231	1,079.99	—	—	L	26	4	7 / 0	46-3/4	11/16	1/2	13-5/8	10
	375 H&H Mag.	035200132	1,079.99	—	—	L	24	4	7 / 0	44-3/4	11/16	1/2	13-5/8	12
X-BOLT HIGH GRADE HUNTER, FULL LINE DEALER X-BOLT HUNTER, FULL LINE DEALER														
	243 Win.	035341211	1,469.99	035281211	1,039.99	S	22	5	6 / 8	42	3/4	1-7/16	13-5/8	10
	7mm-08 Rem.	—	—	035281216	1,039.99	S	22	5	6 / 8	42	3/4	1-7/16	13-5/8	9-1/2
	308 Win.	035341218	1,469.99	035281218	1,039.99	S	22	5	6 / 8	42	3/4	1-7/16	13-5/8	12
	270 WSM	035341248	1,509.99	035281248	1,079.99	S	23	4	6 / 11	43	3/4	1-7/16	13-5/8	10
	300 WSM	035341246	1,509.99	035281246	1,079.99	S	23	4	6 / 11	43	3/4	1-7/16	13-5/8	10
	270 Win.	035341224	1,469.99	035281224	1,039.99	L	22	5	6 / 12	42-3/4	3/4	1-7/16	13-5/8	10
	30-06 Sprg.	035341226	1,469.99	035281226	1,039.99	L	22	5	6 / 12	42-3/4	3/4	1-7/16	13-5/8	10
	7mm Rem. Mag.	035341227	1,509.99	035281227	1,079.99	L	26	4	7 / 0	46-3/4	3/4	1-7/16	13-5/8	9-1/2
B	300 Win. Mag.	035341229	1,509.99	035281229	1,079.99	L	26	4	7 / 0	46-3/4	3/4	1-7/16	13-5/8	10





D X-BOLT WHITE GOLD MEDALLION



E X-BOLT RMEF® WHITE GOLD MEDALLION



RMEF Logo Grip Cap



F X-BOLT RMEF® SPECIAL HUNTER



RMEF Logo Grip Cap

D X-BOLT WHITE GOLD MEDALLION E X-BOLT RMEF WHITE GOLD MEDALLION

RECEIVER Stainless steel • Polished finish • Glass bedded • Drilled and tapped for scope mounts • Scroll engraving on front and rear receiver **BARREL** Stainless steel • Polished stainless finish • Free-floating • Hand chambered • Target crown **ACTION** Bolt-action • 60° bolt lift • Adjustable Feather Trigger • Detachable rotary magazine • Top-tang safety • Bolt unlock button **STOCK** Gloss finish Grade IV/V checkered walnut • Raised cheekpiece • Rosewood fore-end grip and pistol grip caps • RMEF® model features logo inset grip cap **FEATURES** Sling swivel studs • Inflex recoil pad

F X-BOLT RMEF SPECIAL HUNTER

RECEIVER Steel • Low-luster blued finish • Glass bedded • Drilled and tapped for scope mounts **BARREL** Matte blued finish • Free-floating • Hand chambered • Target crown **ACTION** Bolt-action • 60° bolt lift • Adjustable Feather Trigger • Detachable rotary magazine • Top-tang safety • Bolt unlock button **STOCK** Satin finish walnut • Raised cheekpiece • Checkered • Rosewood grip cap • RMEF® logo inset grip cap **FEATURES** Sling swivel studs • Inflex recoil pad

NEW 2016	CALIBER	CODE NUMBER	SUGGESTED RETAIL	ACTION SS / Super Short S / Short L / Long	BARREL LENGTH Inches	TOTAL CAPACITY Includes one in the chamber	AVERAGE WEIGHT Lbs. / Oz.	OVERALL LENGTH Inches	DROP AT COMB Inches	DROP AT HEEL Inches	LENGTH OF PULL Inches	RATE OF TWIST Inches
X-BOLT WHITE GOLD MEDALLION												
	223 Rem.	035345208	1,419.99	SS	22	6	6 / 6	41-1/2	3/4	1-7/16	13-5/8	8
	22-250 Rem.	035345209	1,419.99	SS	22	5	6 / 6	41-1/2	3/4	1-7/16	13-5/8	9
	243 Win.	035235211	1,419.99	S	22	5	6 / 8	42	3/4	1-7/16	13-5/8	10
	7mm-08 Rem.	035235216	1,419.99	S	22	5	6 / 8	42	3/4	1-7/16	13-5/8	9-1/2
	308 Win.	035235218	1,419.99	S	22	5	6 / 8	42	3/4	1-7/16	13-5/8	12
	270 WSM	035235248	1,459.99	S	23	4	6 / 8	43	3/4	1-7/16	13-5/8	10
	7mm WSM	035235249	1,459.99	S	23	4	6 / 11	43	3/4	1-7/16	13-5/8	9-1/2
	300 WSM	035235246	1,459.99	S	23	4	6 / 11	43	3/4	1-7/16	13-5/8	10
	25-06 Rem.	035235223	1,419.99	L	24	5	6 / 14	44-3/4	3/4	1-7/16	13-5/8	10
	270 Win.	035235224	1,419.99	L	22	5	6 / 12	42-3/4	3/4	1-7/16	13-5/8	10
	280 Rem.	035235225	1,419.99	L	22	5	6 / 12	42-3/4	3/4	1-7/16	13-5/8	10
D	30-06 Sprg.	035235226	1,419.99	L	22	5	6 / 12	42-3/4	3/4	1-7/16	13-5/8	10
	7mm Rem. Mag.	035235227	1,459.99	L	26	4	7 / 0	46-3/4	3/4	1-7/16	13-5/8	9-1/2
	300 Win. Mag.	035235229	1,459.99	L	26	4	7 / 0	46-3/4	3/4	1-7/16	13-5/8	10
	338 Win. Mag.	035235231	1,459.99	L	26	4	7 / 0	46-3/4	3/4	1-7/16	13-5/8	10
X-BOLT RMEF WHITE GOLD MEDALLION												
E	300 Win. Mag.	035217229	1,539.99	L	26	4	7 / 0	46-3/4	3/4	1-7/16	13-5/8	10
X-BOLT RMEF SPECIAL HUNTER												
F	300 WSM	035218246	1,109.99	S	23	4	6 / 11	43	3/4	1-7/16	13-5/8	10



GO LONG.

Long range shooting puts demands on both abilities and equipment. The new X-Bolt Long Range Hunter is designed to maximize accuracy at extended ranges, yet still be light and maneuverable enough to carry beyond the sight of your truck.



A X-BOLT LONG RANGE HUNTER



Barrel fluting reduces weight and improves cooling



Muzzle Brake



B X-BOLT VARMINT STALKER, MOSSY OAK® BRUSH®

A X-BOLT LONG RANGE HUNTER

RECEIVER Stainless steel • Matte stainless finish • Glass bedded • Drilled and tapped for scope mounts **BARREL** Threaded muzzle brake is easily removed for use with a suppressor (5/8" x 24 threads) • Stainless steel • Fluted • Free-floating • Hand chambered • Target crown **ACTION** Bolt-action • 60° bolt lift • Adjustable Feather Trigger • Detachable rotary magazine • Top-tang safety • Bolt unlock button **STOCK** Composite • Textured gripping surfaces • Palm swell • Carbon fiber finish • Dura-Touch Armor Coating **FEATURES** Sling swivel studs • Inflex recoil pad (Scope and mounts not included)

B X-BOLT VARMINT STALKER, MOSSY OAK BRUSH

RECEIVER Steel • Matte blued finish • Glass bedded • Drilled and tapped for scope mounts **BARREL** Heavy sporter contour • Matte blued finish • Free-floating • Hand chambered • Target crown **ACTION** Bolt-action • 60° bolt lift • Adjustable Feather Trigger • Detachable rotary magazine • Top-tang safety • Bolt unlock button **STOCK** Composite • Textured gripping surfaces • Palm swell • Mossy Oak® Brush® camo finish • Dura-Touch Armor Coating **FEATURES** Sling swivel studs • Inflex recoil pad

NEW 2016	CALIBER	CODE NUMBER	SUGGESTED RETAIL	ACTION SS / Super Short S / Short L / Long	BARREL LENGTH Inches	TOTAL CAPACITY Includes one in the chamber	AVERAGE WEIGHT Lbs. / Oz.	OVERALL LENGTH Inches	DROP AT COMB Inches	DROP AT HEEL Inches	LENGTH OF PULL Inches	RATE OF TWIST Inches
X-BOLT LONG RANGE HUNTER												
	• 6.5 Creedmoor	035375282	1,429.99	S	26	5	7 / 3	46	11/16	1/2	13-5/8	8
	• 270 WSM	035375248	1,469.99	S	26	5	7 / 3	46	11/16	1/2	13-5/8	10
	• 300 WSM	035375246	1,469.99	S	26	5	7 / 3	46	11/16	1/2	13-5/8	10
	• 26 Nosler	035375287	1,469.99	L	26	4	7 / 8	46-3/4	11/16	1/2	13-5/8	8
	• 7mm Rem. Mag.	035375227	1,469.99	L	26	4	7 / 8	46-3/4	11/16	1/2	13-5/8	9-1/2
A	• 300 Win. Mag.	035375229	1,469.99	L	26	4	7 / 8	46-3/4	11/16	1/2	13-5/8	10
X-BOLT VARMINT STALKER, MOSSY OAK BRUSH												
	204 Rgr.	035334274	939.99	SS	24	6	6 / 15	43-1/2	11/16	1/2	13-5/8	12
	223 Rem.	035334208	939.99	SS	24	6	6 / 15	43-1/2	11/16	1/2	13-5/8	12
	22-250 Rem.	035334209	939.99	SS	26	5	7 / 2	45-1/2	11/16	1/2	13-5/8	14
	243 Win.	035334211	939.99	S	24	5	6 / 14	44	11/16	1/2	13-5/8	10
B	308 Win.	035334218	939.99	S	24	5	6 / 13	44	11/16	1/2	13-5/8	12





C X-BOLT ECLIPSE HUNTER



D X-BOLT ECLIPSE TARGET



E X-BOLT ECLIPSE VARMINT

C X-BOLT ECLIPSE HUNTER

RECEIVER Steel • Matte blued finish • Glass bedded • Drilled and tapped for scope mounts **BARREL** Matte blued finish • Free-floating • Hand chambered • Target crown **ACTION** Bolt-action • 60° bolt lift • Adjustable Feather Trigger • Detachable rotary magazine • Top-tang safety • Bolt unlock button **STOCK** Laminated gray satin varnish finish • Thumbhole grip • Monte Carlo cheekpiece • Checkered **FEATURES** Sling swivel studs installed • Inflex recoil pad (Scope and mounts not included)

D X-BOLT ECLIPSE TARGET **E X-BOLT ECLIPSE VARMINT**

RECEIVER Steel • Matte blued finish • Glass bedded • Drilled and tapped for scope mounts **BARREL** Heavy bull • Matte blued finish • Free-floating • Hand chambered • Target crown **ACTION** Bolt-action • 60° bolt lift • Adjustable Feather Trigger is factory set at 3 to 3-1/2 lbs. on Target model • Detachable rotary magazine • Top-tang safety • Bolt unlock button **STOCK** Laminated gray satin varnish finish • Thumbhole grip • Raised cheekpiece **FEATURES** Swivel stud for bipod • Two QD swivel cups • Inflex recoil pad

NEW 2016	CALIBER	CODE NUMBER	SUGGESTED RETAIL	ACTION SS / Super Short S / Short L / Long	BARREL LENGTH Inches	TOTAL CAPACITY Includes one in the chamber	AVERAGE WEIGHT Lbs. / Oz.	OVERALL LENGTH Inches	DROP AT COMB Inches	DROP AT HEEL Inches	LENGTH OF PULL Inches	RATE OF TWIST Inches
X-BOLT ECLIPSE HUNTER												
	243 Win.	035299211	1,019.99	S	22	5	6 / 7	42-1/8	5/8	1/2	13-3/4	10
	308 Win.	035299218	1,019.99	S	22	5	6 / 7	42-1/8	5/8	1/2	13-3/4	12
	7mm-08 Rem.	035299216	1,019.99	S	22	5	6 / 7	42-1/8	5/8	1/2	13-3/4	10
	270 WSM	035299248	1,059.99	S	23	4	7 / 2	43-1/8	5/8	1/2	13-3/4	10
	300 WSM	035299246	1,059.99	S	23	4	7 / 2	43-1/8	5/8	1/2	13-3/4	10
	25-06 Rem.	035299223	1,019.99	L	24	5	7 / 6	44-7/8	5/8	1/2	13-3/4	10
	270 Win.	035299224	1,019.99	L	22	5	7 / 4	42-7/8	5/8	1/2	13-3/4	10
C	30-06 Sprg.	035299226	1,019.99	L	22	5	7 / 5	42-7/8	5/8	1/2	13-3/4	10
	7mm Rem. Mag.	035299227	1,059.99	L	26	4	7 / 8	46-7/8	5/8	1/2	13-3/4	9-1/2
	300 Win. Mag.	035299229	1,059.99	L	26	4	7 / 8	46-7/8	5/8	1/2	13-3/4	10
X-BOLT ECLIPSE TARGET												
	6.5 Creedmoor	035337282	1,069.99	S	28	5	10 / 3	48-1/8	5/8	1/2	13-3/4	8
D	308 Win.	035337218	1,069.99	S	28	5	10 / 0	48-1/8	5/8	1/2	13-3/4	10
X-BOLT ECLIPSE VARMINT												
	204 Rgr.	035338274	1,069.99	SS	26	6	9 / 6	45-5/8	5/8	1/2	13-3/4	12
E	223 Rem.	035338208	1,069.99	SS	26	6	9 / 5	45-5/8	5/8	1/2	13-3/4	12
	22-250 Rem.	035338209	1,069.99	SS	26	5	9 / 5	45-5/8	5/8	1/2	13-3/4	14

THE AB3 — VALUE IN THE 10 RING.

Affordability and performance combine in the Browning AB3 rifle. The straight-shooting AB3 packs feature on top of feature into an affordable package, without sacrificing Browning accuracy and longevity.

AB3™

AB3 FEATURES AND BENEFITS



LARGE BOLT SURFACE

- The robust bolt offers additional rigidity.
- The bolt is machined from solid steel bar stock and machined internally to keep weight low.
- Three locking lugs provide exceptional bolt strength.
- Super smooth chrome bolt finish is great looking, quieter and offers smooth cycling.



INFLEX RECOIL PAD

- Inflex recoil pad softens recoil and allows faster, more accurate second shots.
- Internal structure is designed to pull the rifle down and away from the face to reduce felt recoil.



BOLT LOCK OVERRIDE BUTTON

- The bolt lock override button provides an additional margin of safety when checking and unloading the chamber.
- Located behind the bolt handle, the bolt lock override allows the bolt to be unlocked and opened with the tang safety in the on safe position.
- The convenient tang safety blocks the trigger sear and sear.



DETACHABLE MAGAZINE

- Polymer and steel construction is lightweight and extra tough.
- Unique spring and follower design minimizes follower tilt for more reliable feeding.



FREE-FLOATING BARREL

- Free-floating maintains barrel to stock spacing for consistent accuracy.
- Recessed muzzle crown helps protect the rifling from damage.
- Precision button-rifled barrel is triple checked for interior finish, straightness and air-gauged for uniformity.
- Hand-reamed chamber for precision accuracy.



60° BOLT LIFT

- Short 60° bolt lift is fast cycling and the hand easily clears the scope.

ALL BROWNING FIREARMS ARE SHIPPED WITH A FREE LOCKING DEVICE TO ASSIST IN THE SAFE STORAGE OF FIREARMS.



TOUGH DECISIONS.

There are many choices to pick from within the value bolt-action rifle category, but how many guns can boast of models with a stock built from either rugged composite or handsomely-finished walnut? The Browning AB3 confidently can. Choosing one may be a tough decision, but either way you won't go wrong.



A AB3 HUNTER



B AB3 COMPOSITE STALKER

A AB3 HUNTER B AB3 COMPOSITE STALKER

RECEIVER Steel • Matte blued finish • Drilled and tapped for scope mounts **BARREL** Matte blued finish • Free-floating • Hand chambered • Target crown **ACTION** Bolt-action • 60° bolt lift • Detachable box magazine • Top-tang safety • Bolt lock override button **STOCK** Satin finish checkered walnut or composite with textured gripping surfaces **FEATURES** Sling swivel studs installed • Inflex recoil pad (Scope and mounts not included)

NEW 2016	CALIBER	CODE NUMBER	SUGGESTED RETAIL	ACTION S/Short L/Long	BARREL LENGTH Inches	TOTAL CAPACITY Includes one in the chamber	AVERAGE WEIGHT Lbs. / Oz.	OVERALL LENGTH Inches	DROP AT COMB Inches	DROP AT HEEL Inches	LENGTH OF PULL Inches	RATE OF TWIST Inches
AB3 HUNTER												
•	243 Win.	035801211	669.99	S	22	6	6 / 13	42	11/16	1/2	13-5/8	10
•	7mm-08 Rem.	035801216	669.99	S	22	6	6 / 12	42	11/16	1/2	13-5/8	9-1/2
•	308 Win.	035801218	669.99	S	22	6	6 / 11	42	11/16	1/2	13-5/8	12
•	270 WSM	035801248	669.99	S	23	4	6 / 13	43	11/16	1/2	13-5/8	10
•	300 WSM	035801246	669.99	S	23	4	6 / 14	43	11/16	1/2	13-5/8	10
•	270 Win.	035801224	669.99	L	22	5	6 / 15	42-3/4	11/16	1/2	13-5/8	10
•	30-06 Sprg.	035801226	669.99	L	22	5	6 / 15	42-3/4	11/16	1/2	13-5/8	10
A	• 7mm Rem. Mag.	035801227	669.99	L	26	4	7 / 6	46-3/4	11/16	1/2	13-5/8	9-1/2
	• 300 Win. Mag.	035801229	669.99	L	26	4	7 / 6	46-3/4	11/16	1/2	13-5/8	10
AB3 COMPOSITE STALKER												
	243 Win.	035800211	599.99	S	22	6	6 / 11	42	11/16	1/2	13-5/8	10
	7mm-08 Rem.	035800216	599.99	S	22	6	6 / 10	42	11/16	1/2	13-5/8	9-1/2
	308 Win.	035800218	599.99	S	22	6	6 / 9	42	11/16	1/2	13-5/8	12
	270 WSM	035800248	599.99	S	23	4	6 / 11	43	11/16	1/2	13-5/8	10
	300 WSM	035800246	599.99	S	23	4	6 / 12	43	11/16	1/2	13-5/8	10
B	270 Win.	035800224	599.99	L	22	5	6 / 13	42-3/4	11/16	1/2	13-5/8	10
	30-06 Sprg.	035800226	599.99	L	22	5	6 / 13	42-3/4	11/16	1/2	13-5/8	10
	7mm Rem. Mag.	035800227	599.99	L	26	4	7 / 3	46-3/4	11/16	1/2	13-5/8	9-1/2
	300 Win. Mag.	035800229	599.99	L	26	4	7 / 3	46-3/4	11/16	1/2	13-5/8	10







MOST WANTED LIST

Join singer, songwriter and hunter Kristy Lee Cook and her friends Jess Hull and Jessi Jo Stanfill on their new TV adventure, *Most Wanted List* on the Sportsman Channel. Learn more about the ladies and their all new Browning show in the bio on page 309.

WORK IT.

Lever-action rifles will always have a place among those who appreciate a quick handling, fast cycling and sure shooting rifle. Unlike most lever guns, the Browning BLR features a detachable box magazine that feeds superior pointed bullets, in modern calibers, for accuracy that rivals many bolt-action rifles.

BLR FEATURES AND BENEFITS



RECEIVER

- Lightweight, sturdy machined aircraft-grade aluminum. Drilled and tapped to accept scope mounts.



ACTION

- Lightning fast, glass-smooth rack and pinion lever-action.
- Strong rotating head, multiple-lug breech bolt with a recessed bolt face and side ejection.



HAMMER

- The folding hammer provides an added measure of safety when the hammer is at half-cock.
- The fold-down hammer has two positions at half-cock so the status of the rifle is readily seen; and four basic positions: Full-cock, half-cock, folded hammer position and the dropped, or fired position.



TAKEDOWN FEATURES

- BLR Takedown models are just as accurate and reliable as their unified counterparts but much easier to transport and store.
- The rifle is easily and quickly assembled by simply sliding the barrel half into the receiver half and locking them together with the flip of a lever. The lever mechanically engages a stout locking lug into a recess in the bottom of the receiver. The system is rugged, precise and blends seamlessly into the styling of the rifle.

ALL BROWNING FIREARMS ARE SHIPPED WITH A FREE LOCKING DEVICE TO ASSIST IN THE SAFE STORAGE OF FIREARMS.



A BLR LIGHTWEIGHT '81 STAINLESS TAKEDOWN



RECEIVER Aircraft-grade alloy • Satin nickel finish • Drilled and tapped for scope mounts **BARREL** Matte stainless steel finish • Crowned muzzle • Adjustable sights • Drilled and tapped for scout scope mount (not included, see page 171) **ACTION** Lever-action • Rotating bolt • Detachable box magazine **STOCK** Satin finish gray laminate wood • Checkered straight grip **FEATURES** Recoil pad • Separates for storage or transportation • Optional scout-style scope mount available • TRUGLO®/Marble Arms® fiber-optic front sight

NEW 2016	CALIBER	CODE NUMBER	SUGGESTED RETAIL	ACTION S/Short L/Long	BARREL LENGTH Inches	TOTAL CAPACITY Includes one in the chamber	AVERAGE WEIGHT LBS./OZ.	OVERALL LENGTH Inches	SIGHT RADIUS Inches	DROP AT COMB Inches	DROP AT HEEL Inches	LENGTH OF PULL Inches	RATE OF TWIST Inches
BLR LIGHTWEIGHT '81 STAINLESS TAKEDOWN													
	223 Rem.	034015108	1,229.99	S	20	5	6 / 8	40	17-3/4	7/8	15/16	13-3/4	12
	22-250 Rem.	034015109	1,229.99	S	20	5	6 / 8	40	17-3/4	7/8	15/16	13-3/4	14
	243 Win.	034015111	1,229.99	S	20	5	6 / 8	40	17-3/4	7/8	15/16	13-3/4	10
	7mm-08 Rem.	034015116	1,229.99	S	20	5	6 / 8	40	17-3/4	7/8	15/16	13-3/4	9-1/2
A	308 Win.	034015118	1,229.99	S	20	5	6 / 8	40	17-3/4	7/8	15/16	13-3/4	12
	358 Win.	034015120	1,229.99	S	20	5	6 / 8	40	17-3/4	7/8	15/16	13-3/4	12
	450 Marlin	034015150	1,229.99	S	20	4	7 / 0	40	17-3/4	7/8	15/16	13-3/4	20
	270 WSM	034015148	1,299.99	S	22	4	6 / 12	42	19-3/4	7/8	15/16	13-3/4	10
	300 WSM	034015146	1,299.99	S	22	4	6 / 12	42	19-3/4	7/8	15/16	13-3/4	10
	270 Win.	034015124	1,279.99	L	22	5	7 / 4	43	19-3/4	1	1-3/8	14-1/4	10
	30-06 Sprg.	034015126	1,279.99	L	22	5	7 / 4	43	19-3/4	1	1-3/8	14-1/4	10
	7mm Rem. Mag.	034015127	1,279.99	L	24	4	7 / 12	45	20	1	1-3/8	14-1/4	9-1/2
	300 Win. Mag.	034015129	1,279.99	L	24	4	7 / 12	45	20	1	1-3/8	14-1/4	10



B BLR LIGHTWEIGHT '81

RECEIVER Aircraft-grade alloy • Blued finish • Drilled and tapped for scope mounts **BARREL** Blued finish • Crowned muzzle • Adjustable sights **ACTION** Lever-action • Rotating bolt • Detachable box magazine **STOCK** Gloss finish walnut • Checkered • Straight grip **FEATURES** Recoil pad

C BLR LIGHTWEIGHT STAINLESS WITH PISTOL GRIP **D BLR LIGHTWEIGHT WITH PISTOL GRIP**

RECEIVER Aircraft-grade alloy • Satin nickel finish or polished blued finish • Drilled and tapped for scope mounts **BARREL** Matte stainless steel or polished blued finish • Crowned muzzle • Adjustable sights **ACTION** Lever-action • Rotating bolt • Detachable box magazine **STOCK** Gloss finish walnut • Checkered pistol grip with Schnabel forearm **FEATURES** Sling swivel studs • Recoil pad

NEW 2016	CALIBER	CODE NUMBER	SUGGESTED RETAIL	ACTION S / Short L / Long	BARREL LENGTH Inches	TOTAL CAPACITY Includes one in the chamber	AVERAGE WEIGHT Lbs. / Oz.	OVERALL LENGTH Inches	SIGHT RADIUS Inches	DROP AT COMB Inches	DROP AT HEEL Inches	LENGTH OF PULL Inches	RATE OF TWIST Inches
BLR LIGHTWEIGHT '81													
	223 Rem.	034006108	959.99	S	20	5	6 / 8	40	17-3/4	7/8	15/16	13-3/4	12
	22-250 Rem.	034006109	959.99	S	20	5	6 / 8	40	17-3/4	7/8	15/16	13-3/4	14
	243 Win.	034006111	959.99	S	20	5	6 / 8	40	17-3/4	7/8	15/16	13-3/4	10
	7mm-08 Rem.	034006116	959.99	S	20	5	6 / 8	40	17-3/4	7/8	15/16	13-3/4	9-1/2
	308 Win.	034006118	959.99	S	20	5	6 / 8	40	17-3/4	7/8	15/16	13-3/4	12
	358 Win.	034006120	959.99	S	20	5	6 / 8	40	17-3/4	7/8	15/16	13-3/4	12
B	270 WSM	034006148	1,039.99	S	22	4	6 / 12	42	19-3/4	7/8	15/16	13-3/4	10
	300 WSM	034006146	1,039.99	S	22	4	6 / 12	42	19-3/4	7/8	15/16	13-3/4	10
	270 Win.	034006124	1,019.99	L	22	5	7 / 4	43	19-3/4	1	1-3/8	14-1/4	10
	30-06 Sprg.	034006126	1,019.99	L	22	5	7 / 4	43	19-3/4	1	1-3/8	14-1/4	10
	7mm Rem. Mag.	034006127	1,019.99	L	24	4	7 / 12	45	20	1	1-3/8	14-1/4	9-1/2
	300 Win. Mag.	034006129	1,019.99	L	24	4	7 / 12	45	20	1	1-3/8	14-1/4	10
BLR LIGHTWEIGHT STAINLESS WITH PISTOL GRIP													
	223 Rem.	034018108	1,099.99	S	20	5	6 / 8	40	17-3/4	1	15/16	13-3/4	12
	22-250 Rem.	034018109	1,099.99	S	20	5	6 / 8	40	17-3/4	1	15/16	13-3/4	14
	243 Win.	034018111	1,099.99	S	20	5	6 / 8	40	17-3/4	1	15/16	13-3/4	10
	7mm-08 Rem.	034018116	1,099.99	S	20	5	6 / 8	40	17-3/4	1	15/16	13-3/4	9-1/2
	308 Win.	034018118	1,099.99	S	20	5	6 / 8	40	17-3/4	1	15/16	13-3/4	12
	358 Win.	034018120	1,099.99	S	20	5	6 / 8	40	17-3/4	1	15/16	13-3/4	12
	450 Marlin	034018150	1,099.99	S	20	4	7 / 0	40	17-3/4	1	15/16	13-3/4	20
C	270 WSM	034018148	1,179.99	S	22	4	6 / 12	42	19-3/4	1	15/16	13-3/4	10
	300 WSM	034018146	1,179.99	S	22	4	6 / 12	42	19-3/4	1	15/16	13-3/4	10
	270 Win.	034018124	1,149.99	L	22	5	7 / 4	43	19-3/4	7/8	15/16	14-1/4	10
	30-06 Sprg.	034018126	1,149.99	L	22	5	7 / 4	43	19-3/4	7/8	15/16	14-1/4	10
	7mm Rem. Mag.	034018127	1,149.99	L	24	4	7 / 12	45	20	7/8	15/16	14-1/4	9-1/2
	300 Win. Mag.	034018129	1,149.99	L	24	4	7 / 12	45	20	7/8	15/16	14-1/4	10
BLR LIGHTWEIGHT WITH PISTOL GRIP													
	223 Rem.	034009108	1,019.99	S	20	5	6 / 8	40	17-3/4	7/8	15/16	13-3/4	12
	22-250 Rem.	034009109	1,019.99	S	20	5	6 / 8	40	17-3/4	7/8	15/16	13-3/4	14
	243 Win.	034009111	1,019.99	S	20	5	6 / 8	40	17-3/4	7/8	15/16	13-3/4	10
	7mm-08 Rem.	034009116	1,019.99	S	20	5	6 / 8	40	17-3/4	7/8	15/16	13-3/4	9-1/2
D	308 Win.	034009118	1,019.99	S	20	5	6 / 8	40	17-3/4	7/8	15/16	13-3/4	12
	358 Win.	034009120	1,019.99	S	20	5	6 / 8	40	17-3/4	7/8	15/16	13-3/4	12
	450 Marlin	034009150	1,019.99	S	20	4	7 / 0	40	17-3/4	7/8	15/16	13-3/4	20
	270 WSM	034009148	1,099.99	S	22	4	6 / 12	42	17-3/4	7/8	15/16	13-3/4	10
	300 WSM	034009146	1,099.99	S	22	4	6 / 12	42	19-3/4	7/8	15/16	13-3/4	10
	270 Win.	034009124	1,069.99	L	22	5	7 / 4	43	19-3/4	1	1	14-1/4	10
	30-06 Sprg.	034009126	1,069.99	L	22	5	7 / 4	43	19-3/4	1	1	14-1/4	10
	7mm Rem. Mag.	034009127	1,069.99	L	24	4	7 / 12	45	20	1	1	14-1/4	9-1/2
	300 Win. Mag.	034009129	1,069.99	L	24	4	7 / 12	45	20	1	1	14-1/4	10



BOUNDLESS HUNTING™

William and McLean Russell make up the duo that hosts *Boundless Hunting* on the Pursuit Channel. Learn more about the brothers and their show in the bio on page 306.



THE NEW BAR MK 3.

Very few companies can boast of a single firearm that helped to shape history. Browning, well, let's just say that we can. One of the most famous is the Browning Automatic Rifle, the BAR. Its story began back in 1917 as a tool designed for American troops during the First World War. The BAR then saw combat in every major U.S. conflict, extending even into the early days of Vietnam. While it shares a name common with Browning's original, the new sporting BAR MK 3 is ready to provide the rugged performance and accuracy that hunters demand and will serve to further engrave the name BAR into the history books.



A BAR MK 3

BAR FEATURES AND BENEFITS



ACTION

- The BAR is a gas-operated autoloader with a high-strength, multiple-lug rotating bolt that locks directly into the barrel.
- The seven-lug bolt and precise breech-to-chamber relationship give the BAR exceptional accuracy and the strength to handle magnum loads.
- The strong and rigid action bar/inertia block link-up improves accuracy by reducing barrel vibration.
- The buffering system reduces wear and stress on the rifle's mechanism.

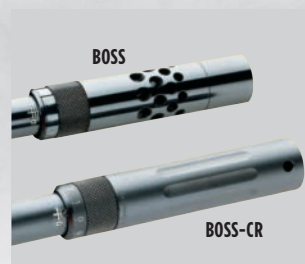

THE BOSS DEVICE

- The Ballistic Optimizing Shooting System (BOSS) is designed to maximize accuracy.
- The BOSS device quickly and easily tunes barrel harmonics to precisely match the specific ammunition fired, resulting in amazingly tight groups. The BOSS device is available as an option on the BAR Mark II Safari.



MK 3 Engraving, Right

RECEIVER Aircraft-grade alloy • Satin nickel finish • High-relief engraving • Drilled and tapped for scope mounts **BARREL** Blued finish • Hammer-forged **ACTION** Gas-operated autoloader • Multi-lug rotary bolt • Detachable box magazine • Composite trigger guard and floorplate • Crossbolt safety **STOCK** Oil finish Grade II walnut • Stylized forearm • Checkered • Shim adjustable for cast on/off and drop at comb **FEATURES** Sling swivel studs installed

NEW 2016	CALIBER	CODE NUMBER	SUGGESTED RETAIL	BARREL LENGTH Inches	TOTAL CAPACITY Includes one in the chamber	AVERAGE WEIGHT Lbs. / Oz.	OVERALL LENGTH Inches	DROP AT COMB Inches	DROP AT HEEL Inches	LENGTH OF PULL Inches	RATE OF TWIST Inches
BAR MARK MK 3											
•	243 Win.	031047211	1,239.99	22	5	7 / 2	43-3/8	7/8	1-1/8	13-3/4	10
•	7mm-08 Rem.	031047216	1,239.99	22	5	7 / 2	43-3/8	7/8	1-1/8	13-3/4	9-1/2
•	308 Win.	031047218	1,239.99	22	5	7 / 2	43-3/8	7/8	1-1/8	13-3/4	12
•	270 WSM	031047248	1,339.99	23	4	7 / 6	44-3/8	7/8	1-1/8	13-3/4	10
•	300 WSM	031047246	1,339.99	23	4	7 / 6	44-3/8	7/8	1-1/8	13-3/4	10
•	270 Win.	031047224	1,239.99	22	5	7 / 2	43-3/8	7/8	1-1/8	13-3/4	10
A	30-06 Sprg.	031047226	1,239.99	22	5	7 / 2	43-3/8	7/8	1-1/8	13-3/4	10
•	7mm Rem. Mag.	031047227	1,339.99	24	4	7 / 11	45-3/8	7/8	1-1/8	13-3/4	9-1/2
•	300 Win. Mag.	031047229	1,339.99	24	4	7 / 11	45-3/8	7/8	1-1/8	13-3/4	10



MAGAZINE

- Detachable box magazine with a unique hinged floorplate allows the shooter to lower the floorplate, detach the empty magazine and snap in a full magazine in mere seconds.



RECEIVER

- The BAR Mark II Safari uses a blued one-piece ordnance steel receiver with scroll engraving.
- The BAR MK 3 is built on an aircraft-grade aluminum alloy receiver.
- All BAR rifles are drilled and tapped for scope mounts. The bolt release lever is incorporated into the receiver.

ALL BROWNING FIREARMS ARE SHIPPED WITH A FREE LOCKING DEVICE TO ASSIST IN THE SAFE STORAGE OF FIREARMS.



A BAR MARK II SAFARI

RECEIVER Steel • Blued finish • Scroll engraving • Drilled and tapped for scope mounts **BARREL** Blued finish • Hammer-forged **ACTION** Gas-operated autoloader • Multi-lug rotary bolt • Detachable box magazine • Crossbolt safety **STOCK** Select gloss finish walnut • Rounded forearm • Checkered **FEATURES** Sling swivel studs installed • Recoil pad • Available with BOSS device, BOSS-CR device optional (Scope and mounts not included)

NEW 2016	CALIBER	CODE NUMBER	SUGGESTED RETAIL	BARREL LENGTH Inches	TOTAL CAPACITY Includes one in the chamber	AVERAGE WEIGHT Lbs. / Oz.	OVERALL LENGTH Inches	DROP AT COMB Inches	DROP AT HEEL Inches	LENGTH OF PULL Inches	RATE OF TWIST Inches
BAR MARK II SAFARI (NOT SHOWN)											
	308 Win.	031001218	1,229.99	22	5	7 / 14	43	3/4	1-1/8	13-3/4	12
	25-06 Rem.	031001223	1,229.99	24	5	8 / 0	45	3/4	1-1/8	13-3/4	10
	270 Win.	031001224	1,229.99	22	5	7 / 14	43	3/4	1-1/8	13-3/4	10
	30-06 Sprg.	031001226	1,229.99	22	5	7 / 14	43	3/4	1-1/8	13-3/4	10
	300 Win. Mag.	031001229	1,349.99	24	4	8 / 0	45	3/4	1-1/8	13-3/4	10
BAR MARK II SAFARI WITH BOSS											
	270 Win.	031001324	1,389.99	22	5	8 / 1	43	3/4	1-1/8	13-3/4	10
A	30-06 Sprg.	031001326	1,389.99	22	5	8 / 1	43	3/4	1-1/8	13-3/4	10
	300 Win. Mag.	031001329	1,499.99	24	4	8 / 3	45	3/4	1-1/8	13-3/4	10
	338 Win. Mag.	031001331	1,499.99	24	4	8 / 3	45	3/4	1-1/8	13-3/4	10



BOSS-CR ACCESSORY

The BOSS-CR accessory offers all the accuracy and tunable advantages of the original BOSS device without the muzzle brake feature. By simply replacing the original BOSS forward weight and recoil reduction components with the one-piece, non-ported BOSS-CR accessory, only the reduced recoil of the original BOSS is sacrificed. The BOSS-CR accessory is designed to fit only BAR Mark II and A-Bolt centerfire rifles previously factory-fitted with the BOSS. **GLOSS BLUED** for BAR Safari; A-Bolt models: Medallion and Gold Medallion **MATTE BLUED** for A-Bolt models: Composite Stalker, Hunter, Euro-Bolt, Varmint, Eclipse Hunter and M-1000 Eclipse **STAINLESS** for A-Bolt models: Stainless Stalker, White Gold, Medallion and M-1000 Eclipse **IT IS IMPORTANT THAT THE CORRECT BOSS-CR BE SELECTED FOR A SPECIFIC CALIBER AND MODEL OF RIFLE.**

DESCRIPTION	SUGGESTED RETAIL
Gloss Blued	39.99
Matte Blued	
Stainless	



CALIBER	GLOSS BLUED	MATTE BLUED	STAINLESS
	CODE NUMBER	CODE NUMBER	CODE NUMBER
223 Rem.	1140011	1140012	1140013
223 Varmint	1140061	1140062	—
223 WSSM	1140011	1140012	1140013
243 WSSM	1140011	1140012	1140013
25 WSSM	1140011	1140012	1140013
22-250 Rem.	1140011	1140012	1140013
22-250 Varmint	1140061	1140062	—
22-250 Varmint (M-1000)	—	1140062	1140063
243 Win.	1140011	1140012	1140013
7mm-08 Rem.	1140011	1140012	1140013
308 Win.	1140021	1140022	1140023
308 Varmint	1140061	1140062	—
308 Varmint (M-1000)	—	1140062	1140063
25-06 Rem.	1140011	1140012	1140013
260 Rem.	1140011	1140012	1140013
270 WSM	1140021	1140022	1140023
270 Win.	1140011	1140012	1140013
280 Rem.	1140011	1140012	1140013
30-06 Sprg.	1140031	1140032	1140033
7mm WSM	1140021	1140022	1140023
7mm Rem. Mag.	1140021	1140022	1140023
300 WSM	1140041	1140042	1140043
300 WSM (M-1000)	—	1140092	1140093
300 Win. Mag.	1140041	1140042	1140043
300 Win. Mag. (M-1000)	—	1140092	—
325 WSM	1140051	1140052	1140053
338 Win. Mag.	1140051	1140052	1140053
375 H&H Mag.	1140071	—	1140073

STRAIGHT-UP UNIQUE.

Easy to operate for most every shooter, the straight-pull bolt-action design of the Browning T-Bolt cycles fast and locks up tight for excellent accuracy. Tremendously fun to shoot, T-Bolt rifles are made to the highest standards of quality.

T-BOLT FEATURES AND BENEFITS**STOCK**

- Stocks are full-size to more comfortably fit adults.
- Durable Composite models feature a Monte Carlo comb and include magazine storage in the buttstock.
- Walnut stocked Sporter models feature trim dimensions with a satin finish and cut checkering. Walnut Target/Varmint models feature a Monte Carlo comb and wide forearm for stability on the bench.
- All models include a bedded action and dual action screws for solid attachment.
- Sling swivel studs included.

**TRIGGER**

- The three-lever trigger design combined with a short-travel firing pin give a crisp break, quick lock time, no take-up and minimal overtravel.
- Adjustable for pull weight.

**BUTTSTOCK MAGAZINE STORAGE**

- Composite stock models offer a convenient location to securely store an extra magazine.

**ACTION**

- Receiver is machined from steel barstock.
- Features crossbolt lockup for strength and smooth operation.
- The mainspring runs directly through the massive pivot pin. Cocking effort is split between opening and closing for ease of operation. The bolt features dual extractors and a red cocking indicator band.
- Right-side ejection on both right- and left-hand models.

**SAFETY**

- Top-tang, thumb operated two-position safety can be operated without changing from a shooting grip.

BARREL

- Target/Varmint models feature a 22" medium target profile.
- T-Bolt Sporter models feature a 22" medium sporter profile.
- Barrel is free-floating with a semi-match chamber and target muzzle crown.

OPTICS READY

- Receiver is drilled and tapped for scope mounts (not included). See pages 170-171 for scope rings and bases for T-Bolt rifles.

ALL BROWNING FIREARMS ARE SHIPPED WITH A FREE LOCKING DEVICE TO ASSIST IN THE SAFE STORAGE OF FIREARMS.



22 Long Rifle

17 HMR / 22 WMR

DOUBLE HELIX MAGAZINES

- 10-round capacity.
- The patented Double Helix rotary box magazine uses torsion spring driven interlocking gears for added reliability and easy loading and unloading.





A T-BOLT COMPOSITE SPORTER B T-BOLT COMPOSITE TARGET/VARMINT

RECEIVER Steel • Blued finish • Drilled and tapped for scope mounts **BARREL** Sporter or medium varmint • Blued finish • Free-floating • Semi-match chamber • Recessed crown **ACTION** Straight pull bolt-action • Top-tang safety • Adjustable trigger **STOCK** Composite • Textured gripping surfaces • Matte black • Spare magazine storage compartment **FEATURES** Spare magazine included • Sling swivel studs installed

C T-BOLT SPORTER • T-BOLT SPORTER, LEFT-HAND

D T-BOLT TARGET/VARMINT • T-BOLT TARGET/VARMINT, LEFT-HAND

RECEIVER Steel • Blued finish • Drilled and tapped for scope mounts **BARREL** Sporter or medium varmint • Blued finish • Free-floating • Semi-match chamber • Recessed crown **ACTION** Straight pull bolt-action • Top-tang safety • Adjustable trigger • Right- and left-hand models have right side ejection **STOCK** Satin finish walnut • Checkered **FEATURES** Sling swivel studs installed

NEW 2016	CALIBER	CODE NUMBER	SUGGESTED RETAIL	BARREL LENGTH Inches	TOTAL CAPACITY Includes one in the chamber	AVERAGE WEIGHT Lbs. / Oz.	OVERALL LENGTH Inches	DROP AT COMB Inches	DROP AT HEEL Inches	LENGTH OF PULL Inches	RATE OF TWIST Inches
T-BOLT COMPOSITE SPORTER											
A	22 LR	025179202	749.99	22	11	4 / 9	40-1/4	5/8	5/8	13-1/2	16
	22 WMR	025179204	779.99	22	11	4 / 9	40-1/4	5/8	5/8	13-1/2	16
	17 HMR	025179270	779.99	22	11	4 / 9	40-1/4	5/8	5/8	13-1/2	9
T-BOLT COMPOSITE TARGET/VARMINT											
B	22 LR	025180202	779.99	22	11	5 / 2	40-1/4	5/8	5/8	13-1/2	16
	22 WMR	025180204	799.99	22	11	5 / 2	40-1/4	5/8	5/8	13-1/2	16
	17 HMR	025180270	799.99	22	11	5 / 2	40-1/4	5/8	5/8	13-1/2	9
T-BOLT SPORTER											
C	22 LR	025175202	749.99	22	11	4 / 14	40-1/4	5/8	5/8	13-1/2	16
	22 WMR	025175204	779.99	22	11	4 / 14	40-1/4	5/8	5/8	13-1/2	16
	17 HMR	025175270	779.99	22	11	4 / 14	40-1/4	5/8	5/8	13-1/2	9
T-BOLT SPORTER, LEFT-HAND (NOT SHOWN)											
	22 LR	025184202	749.99	22	11	4 / 14	40-1/4	5/8	5/8	13-1/2	16
	22 WMR	025184204	799.99	22	11	4 / 14	40-1/4	5/8	5/8	13-1/2	16
	17 HMR	025184270	799.99	22	11	4 / 14	40-1/4	5/8	5/8	13-1/2	9
T-BOLT TARGET/VARMINT											
D	22 LR	025176202	779.99	22	11	5 / 8	40-1/4	5/8	5/8	13-1/2	16
	22 WMR	025176204	799.99	22	11	5 / 8	40-1/4	5/8	5/8	13-1/2	16
	17 HMR	025176270	799.99	22	11	5 / 8	40-1/4	5/8	5/8	13-1/2	9
T-BOLT TARGET/VARMINT, LEFT-HAND (NOT SHOWN)											
	22 LR	025185202	799.99	22	11	5 / 8	40-1/4	5/8	5/8	13-1/2	16
	22 WMR	025185204	829.99	22	11	5 / 8	40-1/4	5/8	5/8	13-1/2	16
	17 HMR	025185270	829.99	22	11	5 / 8	40-1/4	5/8	5/8	13-1/2	9

LITTLE LEVERS.

They don't build them like this anymore, but we still do. The Browning BL-22 is a handsome little rimfire rifle that puts rock-solid build quality as first priority. The quick-throw lever action makes shooting quick and accurate. The BL-22 is the perfect, reliable rimfire with long lasting Browning class.

BL-22 FEATURES AND BENEFITS.



RIMFIRE THOROUGHBREDS.

- The slick, lever-action BL-22 is perfect for new and seasoned shooters alike.
- Quick-cycling 33° lever throw.
- The trigger travels with the lever to prevent finger pinch.
- High-quality construction.
- Fires .22 Short, Long and Long Rifle ammunition.
- Short lever throw is ideal for smaller hands.

ALL BROWNING FIREARMS ARE SHIPPED WITH A FREE LOCKING DEVICE TO ASSIST IN THE SAFE STORAGE OF FIREARMS.

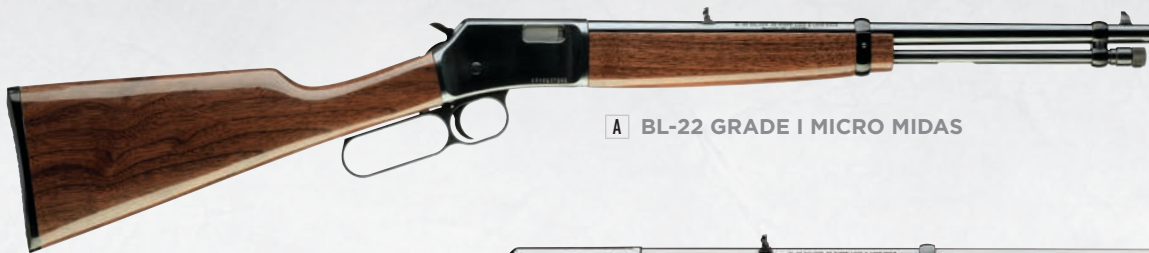

A BL-22 GRADE I MICRO MIDAS

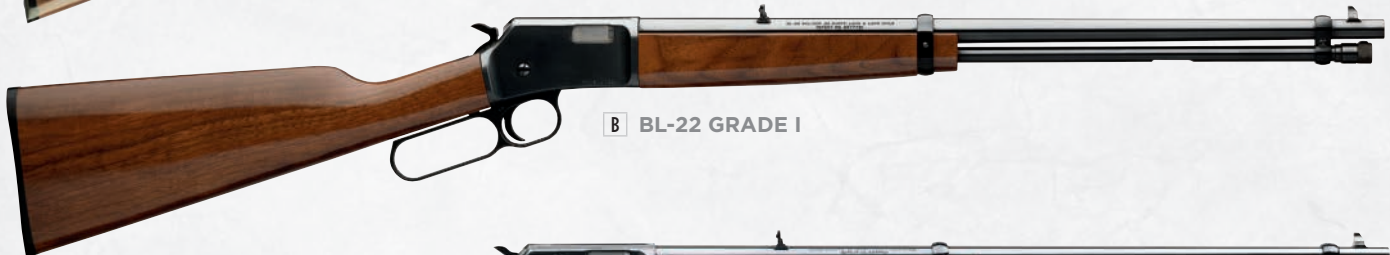

B BL-22 GRADE I



C BL-22 GRADE II

A BL-22 GRADE I MICRO MIDAS

RECEIVER Steel • Blued finish • Grooved for scope mounts **BARREL** Blued finish • Recessed crown **ACTION** Lever-action • Short 33° lever throw • Tubular magazine **STOCK** Gloss finish walnut • Straight grip • Compact 12" length of pull for smaller shooters **FEATURES** Adjustable sights with front bead **ELIGIBLE FOR GROWTH INSURANCE PROGRAM** See page 4 for details

B BL-22 GRADE I C BL-22 GRADE II

RECEIVER Steel • Blued finish • Grooved for scope mounts • Grade II is scroll engraved **BARREL** Blued finish • Recessed crown **ACTION** Lever-action • Short 33° lever throw • Tubular magazine • Grade II has gold-colored trigger **STOCK** Gloss finish American walnut • Straight grip • Grade II has cut checkering **FEATURES** Adjustable sights with front bead

NEW 2016	CALIBER	CODE NUMBER	SUGGESTED RETAIL	BARREL LENGTH Inches	TOTAL CAPACITY Includes one in the chamber	AVERAGE WEIGHT Lbs. / Oz.	OVERALL LENGTH Inches	SIGHT RADIUS Inches	DROP AT COMB Inches	DROP AT HEEL Inches	LENGTH OF PULL Inches	RATE OF TWIST Inches
BL-22 GRADE I MICRO MIDAS												
A	22 LR	024115103	579.99	16-1/4	12	4 / 12	31-1/2	11-5/8	7/8	1-1/2	12	16
BL-22 GRADE I												
B	22 S, L & LR	024100103	619.99	20	16 LR	5 / 0	36-3/4	15-3/8	7/8	1-1/2	13-1/2	16
BL-22 GRADE II												
C	22 S, L & LR	024101103	699.99	20	16 LR	5 / 0	36-3/4	15-3/8	7/8	1-1/2	13-1/2	16

TIMELESS CLASSICS.

Far above entry level, the Browning BL-22 is a rifle folks will be honored to shoot for generations. The fine walnut, satin nickel and richly blued finishes perfectly complement each other — while highlighting the smooth function of the action.



D BL-22 GRADE I, FULL LINE DEALER



E BL-22 GRADE II, FULL LINE DEALER



F BL-22 GRADE II OCTAGON, FULL LINE DEALER



D BL-22 GRADE I, FULL LINE DEALER E BL-22 GRADE II, FULL LINE DEALER

RECEIVER Steel • Satin nickel finish • Grooved for scope mounts • Grade II is scroll engraved **BARREL** Blued finish • Recessed crown **ACTION** Lever-action • Short 33° lever throw • Tubular magazine • Grade II has gold-colored trigger **STOCK** Satin finish American walnut • Straight grip • Grade II has cut checkering **FEATURES** Adjustable sights with front bead • Available only from Browning Full Line and Medallion Dealers

F BL-22 GRADE II OCTAGON, FULL LINE DEALER

RECEIVER Steel • Satin nickel finish • Grooved for scope mounts • Scroll engraved **BARREL** Octagonal • Blued finish • Recessed crown **ACTION** Lever-action • Short 33° lever throw • 3/4 length tubular magazine • Gold-colored trigger **STOCK** Satin finish American walnut • Straight grip • Cut checkering **FEATURES** Adjustable sights with front gold bead • Available only from Browning Full Line and Medallion Dealers

NEW 2016	CALIBER	CODE NUMBER	SUGGESTED RETAIL	BARREL LENGTH Inches	TOTAL CAPACITY Includes one in the chamber	AVERAGE WEIGHT Lbs. / Oz.	OVERALL LENGTH Inches	DROP AT COMB Inches	DROP AT HEEL Inches	LENGTH OF PULL Inches	RATE OF TWIST Inches
BL-22 GRADE I, FULL LINE DEALER											
D	22 S, L & LR	024107102	659.99	20	16 LR	5 / 0	36-3/4	7/8	1-1/2	13-1/2	16
BL-22 GRADE II, FULL LINE DEALER											
E	22 S, L & LR	024108102	749.99	20	16 LR	5 / 0	36-3/4	7/8	1-1/2	13-1/2	16
BL-22 GRADE II OCTAGON, FULL LINE DEALER											
F	22 S, L & LR	024105155	979.99	24	16 LR	5 / 4	40-3/4	7/8	1-1/2	13-1/2	16

PURE GENIUS FROM THE MAN HIMSELF.

Straight from the workbench of John M. Browning comes the SA-22. One of the famous inventor's most time-honored and cherished designs, these compact takedown rifles are a perfect reminder of the talents of the greatest gun designer in history.

SA-22 FEATURES AND BENEFITS



TAKEDOWN FEATURE

- The Semi-Auto 22 can be quickly taken down to a compact length of only 19-3/8" for storage or packing.



BARREL ADJUSTMENT

- The knurled knob allows play to be adjusted out of the barrel to ensure accuracy.



IN-STOCK MAGAZINE

- The magazine is located in the stock to maintain the trim dimensions of the rifle.



BOTTOM EJECTION

- Bottom ejection makes the Semi-Auto 22 ideal for right- or left-handed shooters alike.

ALL BROWNING FIREARMS ARE SHIPPED WITH A FREE LOCKING DEVICE TO ASSIST IN THE SAFE STORAGE OF FIREARMS.





A SEMI-AUTO 22 GRADE I



B SEMI-AUTO 22 GRADE VI BLUED



C SEMI-AUTO 22 GRADE VI GRAYED



Grade VI Engraving, Right

A SEMI-AUTO 22 GRADE I

RECEIVER Steel • Takedown design • Polished blued finish • Scroll engraving **BARREL** Polished blued finish • Drilled and tapped for scope mounts **ACTION** Autoloading • Bottom ejection • Tubular magazine • Crossbolt safety **STOCK** Gloss finish select American walnut • Checkered **FEATURES** Adjustable sights with gold bead front sight blade and folding leaf rear sight • Blued trigger

B SEMI-AUTO 22 GRADE VI BLUED**C SEMI-AUTO 22 GRADE VI GRAYED**

RECEIVER Steel • Takedown design • Polished blued or satin grayed finish • Game scene engraving with 24 karat gold accents **BARREL** Polished blued finish • Drilled and tapped for scope mounts **ACTION** Autoloading • Bottom ejection • Tubular magazine • Crossbolt safety **STOCK** Gloss finish select American walnut • Checkered **FEATURES** Adjustable sights with gold bead front sight blade and folding leaf rear sight • Gold trigger

NEW 2016	CALIBER	CODE NUMBER	SUGGESTED RETAIL	BARREL LENGTH Inches	TOTAL CAPACITY Includes one in the chamber	AVERAGE WEIGHT Lbs. / Oz.	OVERALL LENGTH Inches	SIGHT RADIUS Inches	DROP AT COMB Inches	DROP AT HEEL Inches	LENGTH OF PULL Inches	RATE OF TWIST Inches
SEMI-AUTO 22 GRADE I												
A	22 LR	021001102	699.99	19-3/8	11	5 / 3	37	16-1/4	1-3/16	2-5/8	13-3/4	16
SEMI-AUTO 22 GRADE VI BLUED												
B	22 LR	021002102	1,579.99	19-3/8	11	5 / 3	37	16-1/4	1-3/16	2-5/8	13-3/4	16
SEMI-AUTO 22 GRADE VI GRAYED												
C	22 LR	021003102	1,579.99	19-3/8	11	5 / 3	37	16-1/4	1-3/16	2-5/8	13-3/4	16

ON TARGET FOR FUN.

A Buck Mark Rifle is an ideal rimfire for plinking. Lightweight, compact and nimble, the Buck Mark Rifle is simple to operate, easy to load, accurate and fun to shoot.

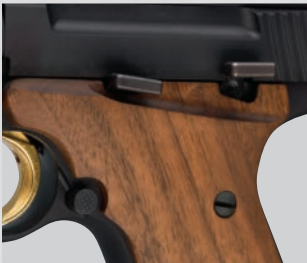
**BUCK MARK RIFLES FEATURES AND BENEFITS****SAFETY AND SLIDE RELEASE**

- Large manual thumb safety.
- The convenient manual slide release is easily operated with the shooting or support hand.

**SIGHTS**

- Sporter model features a TRUGLO®/Marble Arms® fiber-optic sight system.
- The rear sight is adjustable for windage and elevation.

**MAGAZINE RELEASE**

- Located adjacent to the trigger guard for convenient operation.

**ACTION**

- The straight blowback design offers enhanced simplicity and reliability.

**FRAME**

- Machined to exacting tolerances from a solid billet of 7075-T6 aluminum. The stock structure is a part of the pistol frame, reducing weight and the number of parts.

**BARREL**

- Sporter model features lightweight, tapered sporter-weight barrel. Target models feature a bull barrel.
- The chamber in every Buck Mark Rifle barrel is hand-reamed and the muzzle crown is recessed to protect it from damage that could degrade accuracy.

**SLIDE**

- Serrated for an improved cocking grip.

ALL BROWNING FIREARMS ARE SHIPPED WITH A FREE LOCKING DEVICE TO ASSIST IN THE SAFE STORAGE OF FIREARMS.

**Made
in the USA**





A BUCK MARK SPORTER



B BUCK MARK TARGET



C BUCK MARK TARGET GRAY LAMINATE, FULL LINE DEALER

A BUCK MARK SPORTER

RECEIVER Alloy • Matte blued finish **BARREL** Tapered sporter • Matte blued finish • Target crown **ACTION** Blowback • Single-action trigger • Detachable magazine **STOCK** Oil finish walnut
FEATURES TRUGLO®/Marble Arms® adjustable fiber-optic sights • Integral scope rail

B BUCK MARK TARGET

RECEIVER Alloy • Matte blued finish **BARREL** Heavy bull • Matte blued finish • Target crown **ACTION** Blowback • Single-action trigger • Detachable magazine **STOCK** Oil finish walnut
FEATURES Integral scope rail

C BUCK MARK TARGET GRAY LAMINATE, FULL LINE DEALER

RECEIVER Alloy • Matte blued finish **BARREL** Heavy bull • Matte blued finish • Target crown **ACTION** Blowback • Single-action trigger • Detachable magazine **STOCK** Laminated gray satin finish hardwood
FEATURES Integral scope rail • Available only from Browning Full Line and Medallion Dealers

NEW 2016	CALIBER	CODE NUMBER	SUGGESTED RETAIL	BARREL LENGTH Inches	TOTAL CAPACITY Includes one in the chamber	AVERAGE WEIGHT Lbs. / Oz.	OVERALL LENGTH Inches	SIGHT RADIUS Inches	DROP AT COMB Inches	DROP AT HEEL Inches	LENGTH OF PULL Inches	RATE OF TWIST Inches
BUCK MARK SPORTER												
A	22 LR	021026102	699.99	18	11	4 / 6	33-5/8	12-3/8	7/8	1-1/2	15-1/8	16
BUCK MARK TARGET												
B	22 LR	021025202	699.99	18	11	5 / 6	33-5/8	—	7/8	1-1/2	15-1/8	16
BUCK MARK TARGET GRAY LAMINATE, FULL LINE DEALER												
C	22 LR	021030202	719.99	18	11	5 / 8	33-5/8	—	7/8	1-1/2	15-1/8	16



**A HISTORY OF
PISTOL PERFECTION.**

Browning is no stranger to handguns. After all, the most famous autoloader of all time, the Model 1911, was invented by our namesake. That pistol, along with the hard-hitting 45 ACP cartridge it was chambered for, are merely two of the many pistol inventions that poured from the genius of John M. Browning.

Today, along with the Buck Mark and Hi Power, reduced scale 1911 variants are among our line of fine firearms. They are as much a testimony to the man as they are to the longevity of his ideas.

HANDGUNS
®

PUT THE SIGHTS ON PERFORMANCE.

Made in the USA on a machined aluminum frame, the Buck Mark features a precision rifled barrel, crisp trigger and fully-adjustable sights. For competition, target shooting or an afternoon plinking with the family, a Buck Mark is always ready to deliver top-notch performance.



BUCK MARK PISTOLS FEATURES AND BENEFITS



EASY TO REACH CONTROLS

- Large manual thumb safety.
- The convenient manual slide release is easily operated with the shooting or support hand.
- The magazine release is positioned adjacent to the trigger guard for convenient operation.



ACTION

- The straight blowback design offers enhanced simplicity and reliability.



ABS CARRY CASE

- Buck Mark pistols are shipped in a sturdy ABS case.



FRAME

- Machined from aircraft grade aluminum alloy.



BARREL

- Most models have bull barrels for improved stability. Lite models have a steel barrel liner inside an ultralight aluminum sleeve.
- The chamber is hand-reamed and the muzzle crown is recessed to protect it from damage that could degrade accuracy.



MAGAZINE

- The steel magazine body is heat treated for long-term feeding reliability and long life. The coil spring provides a consistent follower angle. 10-round capacity.



SIGHTS

- The 16-click per revolution adjustable Pro-Target™ sight is standard on all models.
- This sight provides a finer degree of adjustment over the industry's standard of 12-clicks per revolution.
- Fiber-optic TRUGLO®/Marble Arms® front sights are available on select models.



GRIPS

- Several wood, laminate and composite styles are available. Overmolded Ultragrip FX (UFX), soft nitrile rubber Ultragrip RX® (URX) and wood Ultragrip Deluxe® (UDX) ambidextrous grips have ergonomic finger grooves for enhanced control.

CALIFORNIA ONLY MODELS

CODE NUMBER	SUGGESTED RETAIL
PLUS STAINLESS UDX, 5-1/2" BARREL	
051427490	579.99
PLUS ROSEWOOD UDX, 5-1/2" BARREL	
051429490	539.99
PLUS UDX, 5-1/2" BARREL	
051428490	539.99
LITE GRAY URX, 7-1/4" BARREL	
051462490	589.99
LITE GRAY URX, 5-1/2" BARREL	
051461490	579.99
LITE GREEN URX, 5-1/2" BARREL	
051459490	579.99
CONTOUR URX, 5-1/2" BARREL	
051421490	549.99
STANDARD STAINLESS URX, 5-1/2" BARREL	
051409490	499.99
STANDARD URX, 5-1/2" BARREL	
051407490	469.99
STANDARD MICRO URX, 4" BARREL	
051408490	469.99
PRACTICAL URX, 5-1/2" BARREL	
051448490	439.99
CAMPER STAINLESS URX, 5-1/2" BARREL	
051442490	469.99
CAMPER STAINLESS UFX, 5-1/2" BARREL	
051483490	429.99
CAMPER UFX, 5-1/2" BARREL	
051482490	389.99

**Made
in the USA**

ALL BROWNING FIREARMS ARE SHIPPED WITH A FREE LOCKING DEVICE TO ASSIST IN THE SAFE STORAGE OF FIREARMS.



A BUCK MARK CAMPER UFX



B BUCK MARK CAMPER STAINLESS UFX



C BUCK MARK CAMPER STAINLESS URX



D BUCK MARK STANDARD URX



E BUCK MARK STANDARD STAINLESS URX



F BUCK MARK STANDARD MICRO URX

- A BUCK MARK CAMPER UFX B BUCK MARK CAMPER STAINLESS UFX
 C BUCK MARK CAMPER STAINLESS URX

RECEIVER Alloy • Matte blued BARREL Tapered bull • 5-1/2" length • Matte blued or stainless finish ACTION Blowback • Single-action trigger GRIPS Ultragrip RX Overmolded or Ultragrip FX ambidextrous FEATURES UFX: Pro-Target adjustable sights, URX: Pro-Target adjustable rear sight and TRUGLO®/Marble Arms® fiber-optic front sight

- D BUCK MARK STANDARD URX E BUCK MARK STANDARD STAINLESS URX
 F BUCK MARK STANDARD MICRO URX

RECEIVER Alloy • Blued finish BARREL Slabside • Standard: 5-1/2" length, Micro: 4" length • Stainless or blued finish with polished flats ACTION Blowback • Single-action trigger GRIPS Ultragrip RX ambidextrous FEATURES Pro-Target adjustable sights

NEW 2016	CALIBER	CODE NUMBER	SUGGESTED RETAIL	CAPACITY	REAR SIGHT	FRONT SIGHT	BARREL LENGTH Inches	AVERAGE WEIGHT Oz.	OVERALL LENGTH Inches	SIGHT RADIUS Inches
BUCK MARK CAMPER UFX										
A	22 LR	051498490	389.99	10	Adjustable	Blade	5-1/2	34	9-1/2	8-1/4
BUCK MARK CAMPER STAINLESS UFX										
B	22 LR	051483490	429.99	10	Adjustable	Blade	5-1/2	34	9-1/2	8-1/4
BUCK MARK CAMPER STAINLESS URX										
C	• 22 LR	051442490	469.99	10	Adjustable	Blade	5-1/2	34	9-1/2	8-1/4
BUCK MARK STANDARD URX										
D	22 LR	051497490	469.99	10	Adjustable	Blade	5-1/2	34	9-1/2	8-1/4
BUCK MARK STANDARD STAINLESS URX										
E	22 LR	051409490	499.99	10	Adjustable	Blade	5-1/2	34	9-1/2	8-1/4
BUCK MARK STANDARD MICRO URX										
F	• 22 LR	051514490	469.99	10	Adjustable	Blade	4	32	8	6-3/4



A BUCK MARK
CONTOUR STAINLESS URX



B BUCK MARK
CONTOUR STAINLESS URX



C BUCK MARK
CONTOUR URX



D BUCK MARK
CONTOUR URX



E BUCK MARK
LITE GRAY URX



F BUCK MARK
LITE GRAY URX



G BUCK MARK
LITE GREEN URX

A B BUCK MARK CONTOUR STAINLESS URX C D BUCK MARK CONTOUR URX

RECEIVER Alloy • Matte blued finish **BARREL** Special contour • Matte stainless or blued finish with polished flats • Full-length scope base • Picatinny cross slots • Available in 5-1/2" and 7-1/4" length
ACTION Blowback • Single-action trigger **GRIPS** Ultragrip RX ambidextrous **FEATURES** Pro-Target adjustable sights • Pistol rug included (not shown)

E F G BUCK MARK LITE URX

RECEIVER Alloy • Matte gray or green finish **BARREL** Alloy sleeve • 5-1/2" or 7-1/4" length • Matte gray or green finish • Fluted **ACTION** Blowback • Single-action trigger **GRIPS** Ultragrip RX ambidextrous
FEATURES Pro-Target adjustable rear sight • TRUGLO®/Marble Arms® fiber-optic front sight

NEW 2016	CALIBER	CODE NUMBER	SUGGESTED RETAIL	CAPACITY	REAR SIGHT	FRONT SIGHT	BARREL LENGTH Inches	AVERAGE WEIGHT Oz.	OVERALL LENGTH Inches	SIGHT RADIUS Inches
BUCK MARK CONTOUR STAINLESS URX										
A	• 22 LR	051507490	579.99	10	Adjustable	Blade	5-1/2	36	9-1/2	8-1/4
B	• 22 LR	051508490	589.99	10	Adjustable	Blade	7-1/4	39	11-1/4	9-3/4
BUCK MARK CONTOUR URX										
C	22 LR	051501490	549.99	10	Adjustable	Blade	5-1/2	36	9-1/2	8-1/4
D	22 LR	051502490	559.99	10	Adjustable	Blade	7-1/4	39	11-1/4	9-3/4
BUCK MARK LITE GRAY URX										
E	22 LR	051500490	579.99	10	Adjustable	Fiber-Optic	5-1/2	34	9-1/2	8-1/4
F	• 22 LR	051517490	589.99	10	Adjustable	Fiber-Optic	7-1/4	39	11-1/4	9-3/4
BUCK MARK LITE GREEN URX										
G	• 22 LR	051516490	579.99	10	Adjustable	Fiber-Optic	5-1/2	34	9-1/2	8-1/4



H BUCK MARK PLUS STAINLESS UDX



I BUCK MARK PLUS ROSEWOOD UDX



J BUCK MARK PLUS UDX



K BUCK MARK HUNTER



L BUCK MARK PRACTICAL URX



M BUCK MARK CHALLENGE ROSEWOOD

H BUCK MARK PLUS STAINLESS UDX I BUCK MARK PLUS ROSEWOOD UDX J BUCK MARK PLUS UDX

RECEIVER Alloy • Matte blued finish • Finger grooves **BARREL** Slabside • Stainless or matte blued with polished flats • 5-1/2" length **ACTION** Blowback • Single-action trigger **GRIPS** UDX, black laminated on stainless, rosewood laminated or brown laminated on blued models **FEATURES** Pro-Target adjustable rear sight • TRUGLO®/Marble Arms® fiber-optic front sight

K BUCK MARK HUNTER

RECEIVER Alloy • Matte blued finish **BARREL** Heavy tapered round bull 7-1/4" length • Matte blued finish • Integral scope base **ACTION** Blowback • Single-action trigger **GRIPS** Laminated cocobolo target **FEATURES** Pro-Target adjustable rear sight • TRUGLO®/Marble Arms® fiber-optic front sight • Pistol rug included (not shown)

L BUCK MARK PRACTICAL URX

RECEIVER Alloy • Matte gray finish **BARREL** Tapered bull 5-1/2" length • Matte blued finish **ACTION** Blowback • Single-action trigger **GRIPS** Ultragrip RX ambidextrous **FEATURES** Pro-Target adjustable rear sight • TRUGLO®/Marble Arms® fiber-optic front sight

M BUCK MARK CHALLENGE ROSEWOOD

RECEIVER Alloy • Matte blued finish • Compact frame fits shooters with smaller hands **BARREL** Light tapered round 5-1/2" length • Matte blued finish **ACTION** Blowback • Single-action trigger **GRIPS** Rosewood laminated • Checkered with scroll engraving **FEATURES** Pro-Target adjustable rear sight • TRUGLO®/Marble Arms® fiber-optic front sight • Pistol rug included (not shown)

NEW 2016	CALIBER	CODE NUMBER	SUGGESTED RETAIL	CAPACITY	REAR SIGHT	FRONT SIGHT	BARREL LENGTH Inches	AVERAGE WEIGHT Oz.	OVERALL LENGTH Inches	SIGHT RADIUS Inches
BUCK MARK PLUS STAINLESS UDX										
H	22 LR	051427490	579.99	10	Adjustable	Fiber-Optic	5-1/2	34	9-1/2	8-1/4
BUCK MARK PLUS ROSEWOOD UDX										
I	• 22 LR	051515490	539.99	10	Adjustable	Fiber-Optic	5-1/2	34	9-1/2	8-1/4
BUCK MARK PLUS UDX										
J	22 LR	051496490	539.99	10	Adjustable	Fiber-Optic	5-1/2	34	9-1/2	8-1/4
BUCK MARK HUNTER										
K	22 LR	051499490	499.99	10	Adjustable	Fiber-Optic	7-1/4	38	11-1/4	10
BUCK MARK PRACTICAL URX										
L	22 LR	051448490	439.99	10	Adjustable	Fiber-Optic	5-1/2	34	9-1/2	8-1/4
BUCK MARK CHALLENGE ROSEWOOD										
M	• 22 LR	051519490	539.99	10	Adjustable	Blade	5-1/2	25	9-1/2	8-1/4

DON'T CALL IT CUTE.

Scaled down to 85% of John M. Browning's original Model 1911 and weighing less than half as much, the 1911-22 comfortably fits into hands of every size. These excellent firearms are ideal for plinking, hunting and target shooting.

1911 22

1911-22 FEATURES AND BENEFITS**SAFETY**

- Large manual thumb safety and grip safety.

**SLIDE**

- Vertical serrations provide an improved cocking grip.
- The convenient manual slide release is easily operated with the shooting or support hand.

**FRAME**

- Aircraft grade aluminum alloy or engineering grade composite.
- Walnut grip panels on select models.

**ACTION**

- The straight blowback design offers enhanced simplicity and reliability.

**MAGAZINE**

- The steel magazine body is heat treated for long-term feeding reliability and long life.
- The coil spring provides a consistent follower angle.
- 10-round capacity.

**MAGAZINE RELEASE**

- Positioned adjacent to the trigger guard for convenient operation.

**ABS CARRY CASE**

- 1911-22 pistols are shipped in a sturdy ABS case.

**Made
in the USA**

**ALL BROWNING FIREARMS ARE SHIPPED
WITH A FREE LOCKING DEVICE TO ASSIST
IN THE SAFE STORAGE OF FIREARMS.**



A



B



C



D

1911-22 ACCESSORY GRIPS

NEW 2016	DESCRIPTION	CODE NUMBER	SUGGESTED RETAIL
A	Imitation Aged Ivory	114111	78.00
B	Imitation Pearl	114121	78.00
C	Rosewood	114131	62.00
D	Black Label	114141	62.00



E 1911-22 A1 FULL SIZE



F 1911-22 A1 COMPACT



G 1911-22 A1 FULL SIZE, DESERT TAN



H 1911-22 A1 COMPACT, DESERT TAN

E 1911-22 A1 FULL SIZE F 1911-22 A1 COMPACT

FRAME Alloy • Matte black finish **SLIDE** Machined aluminum • Matte black finish **BARREL** Full Size: 4-1/4", Compact: 3-5/8" length • Stainless steel barrel block • Target crown **ACTION** Blowback • Single-action trigger **GRIPS** Walnut with double diamond pattern cut checkering **FEATURES** Fixed sights • Detachable 10-round magazine • Manual thumb safety • Grip safety • ABS carry case included

G 1911-22 A1 FULL SIZE, DESERT TAN H 1911-22 A1 COMPACT, DESERT TAN

FRAME Composite • Desert tan color **SLIDE** Machined aluminum • Matte black finish **BARREL** Full Size: 4-1/4", Compact: 3-5/8" length • Stainless steel barrel block • Target crown **ACTION** Blowback • Single-action trigger **GRIPS** Composite **FEATURES** Fixed sights • Detachable 10-round magazine • Manual thumb safety • Grip safety • ABS carry case included

NEW 2016 CA COMPLIANT	CALIBER	CODE NUMBER	SUGGESTED RETAIL	CAPACITY	SIGHTS	FINISH	GRIPS	BARREL LENGTH Inches	AVERAGE WEIGHT Oz.	OVERALL LENGTH Inches	SIGHT RADIUS Inches
1911-22 A1 FULL SIZE											
E	• 22 LR	051802490	599.99	10	Fixed	Matte Black	Walnut	4-1/4	15-1/2	7-3/8	5-1/2
1911-22 A1 COMPACT											
F	• 22 LR	051803490	599.99	10	Fixed	Matte Black	Walnut	3-5/8	15	6-3/4	4-7/8
1911-22 A1 FULL SIZE, DESERT TAN											
G	• 22 LR	051808490	579.99	10	Fixed	Matte Black	Composite	4-1/4	14	7-3/8	5-1/2
1911-22 A1 COMPACT, DESERT TAN											
H	• 22 LR	051810490	579.99	10	Fixed	Matte Black	Composite	3-5/8	13-1/2	6-3/4	4-7/8

**INCLUDES
ABS CASE**

READY FOR FUN.

Black Label Model 1911-22s include an impressive list of extras that improve the functionality and shootability of these handguns. Accurate and reliable, the lightweight 1911-22 fits hands of nearly every size.

1911 22

BLACK LABEL 1911-22 FEATURES AND BENEFITS



EXTENDED AMBIDEXTROUS SAFETY

- Ambidextrous thumb safety is easy to operate for both right- and left-handed shooters.
- Extended design is easier to reach with the strong hand and ensures secure thumb engagement.



ABS CARRY CASE

- Black Label 1911-22 pistols are shipped in a sturdy ABS case.



BEAVERTAIL GRIP SAFETY

- The beavertail design prevents the hand from being pinched between the grip safety and the hammer.
- Raised bump ensures positive operation.



FLAT MAINSPRING HOUSING

- Makes the grip more comfortable for a wider range of shooters.

ALL BROWNING FIREARMS ARE SHIPPED WITH A FREE LOCKING DEVICE TO ASSIST IN THE SAFE STORAGE OF FIREARMS.



FRAME

- Engineering grade composite.
- Laminated grip panels.



MAGAZINE

- The steel magazine body is heat treated for long-term feeding reliability and long life.
- The coil spring provides a consistent follower angle.
- 10-round capacity.



COMBAT-STYLE SIGHTS

- Combat-style sights offer rapid target acquisition.



STEEL 3-DOT SIGHTS

- Sturdy steel construction.
- Three-dot style for easy alignment.

Made
in the
USA



A BLACK LABEL 1911-22 FULL SIZE



B BLACK LABEL 1911-22 FULL SIZE WITH RAIL

UNEXPECTED EXTRAS.

All Browning Black Label 1911-22 models include an impressive list of extras. An extended thumb safety and slide stop, and a skeletonized hammer make manipulation easier and more positive. The beavertail grip safety allows a higher hold and prevents hammer bite. The flat mainspring housing ensures more positive operation of the grip safety. Combat-style sights allow for faster target acquisition.



C BLACK LABEL 1911-22 COMPACT



D BLACK LABEL 1911-22 COMPACT WITH RAIL



E BLACK LABEL 1911-22 FULL SIZE WITH RAIL, SUPPRESSOR READY



F BLACK LABEL 1911-22 COMPACT WITH RAIL, SUPPRESSOR READY

FRAME Composite **SLIDE** Machined aluminum • Matte black finish **BARREL** Full Size: 4-1/4", Compact: 3-5/8" length • Suppressor ready models: Full Size: 4-7/8", Compact: 4-1/4" length • Stainless steel barrel block • Target crown • Suppressor ready models include threaded muzzle protector **ACTION** Blowback • Single-action trigger **GRIPS** Laminated wood (Suppressor ready models feature textured G-10 composite) **FEATURES** Fixed combat sights, Suppressor ready models feature steel three-dot sights dovetailed into slide • Detachable 10-round magazine • Extended, ambidextrous manual thumb safety • Extended slide release • Beavertail grip safety • Skeletonized hammer • Available with or without accessory rail on dust cover • ABS carry case included

NEW 2016	CA COMPLIANT	CALIBER	CODE NUMBER	SUGGESTED RETAIL	CAPACITY	SIGHTS	FINISH	GRIPS	BARREL LENGTH Inches	AVERAGE WEIGHT Oz.	OVERALL LENGTH Inches	SIGHT RADIUS Inches
BLACK LABEL 1911-22 FULL SIZE												
A		22 LR	051814490	639.99	10	Fixed	Matte Black	Lam. Wood	4-1/4	14	7-1/2	5-3/8
BLACK LABEL 1911-22 FULL SIZE WITH RAIL												
B		22 LR	051816490	669.99	10	Fixed	Matte Black	Lam. Wood	4-1/4	14	7-1/2	5-3/8
BLACK LABEL 1911-22 COMPACT												
C		22 LR	051815490	639.99	10	Fixed	Matte Black	Lam. Wood	3-5/8	13	6-7/8	4-3/4
BLACK LABEL 1911-22 COMPACT WITH RAIL												
D		22 LR	051817490	669.99	10	Fixed	Matte Black	Lam. Wood	3-5/8	13	6-7/8	4-3/4
BLACK LABEL 1911-22 FULL SIZE WITH RAIL, SUPPRESSOR READY												
E	•	22 LR	051820490	739.99	10	Fixed	Matte Black	G-10	4-7/8	14	8-1/8	5-3/8
BLACK LABEL 1911-22 COMPACT WITH RAIL, SUPPRESSOR READY												
F	•	22 LR	051821490	739.99	10	Fixed	Matte Black	G-10	4-1/4	14	7-1/2	4-3/4

**INCLUDES
ABS CASE**

THE RIGHT 380.

Though 15% smaller than the original 45 ACP versions, the single-action 1911-380 still feels familiar in the hands. The precision built composite frame includes extras like extended controls to make operation easier. Easily controllable with light recoil, the 1911-380 is ideal for new shooters, sport shooting and personal protection. The 1911-380 is proudly made in the USA.

1911 380

BLACK LABEL 1911-380 FEATURES AND BENEFITS



EXTENDED AMBIDEXTRIOUS SAFETY

- Ambidextrous thumb safety is easy to operate.
- Extended design is easier to reach with the strong hand.



MAGAZINE

- The steel magazine body is heat treated for long-term feeding reliability and long life.
- 8-round capacity.



BEAVERTAIL GRIP SAFETY

- The beavertail design prevents bite to the hand from the grip safety.
- Raised bump ensures positive operation.



FLAT MAINSPRING HOUSING

- Makes the grip more comfortable for a wider range of shooters.



FRAME

- Engineering grade composite.
- Composite grip panels.



ABS CARRY CASE

- The Black Label 1911-380 pistol is shipped in a sturdy ABS case.

**Made
in the
USA**

ALL BROWNING FIREARMS ARE SHIPPED WITH A FREE LOCKING DEVICE TO ASSIST IN THE SAFE STORAGE OF FIREARMS.



SIGHTS

- Combat-style sights offer rapid target acquisition.



STEEL 3-DOT SIGHTS

- Sturdy steel construction.
- Three-dot style for easy alignment.



STEEL BAR-DOT NIGHT SIGHTS

- Provides superior visibility in low light situations.
- Sturdy steel construction.
- Stacking the dot on the bar is the fastest, simplest system to use in low light to acquire a target.



A



B



C



D

BLACK LABEL 1911-380 ACCESSORY GRIPS

NEW 2016	DESCRIPTION	CODE NUMBER	SUGGESTED RETAIL
A	Imitation Aged Ivory	114111	78.00
B	Imitation Pearl	114121	78.00
C	Rosewood	114131	62.00
D	Black Label	114141	62.00

A PAIR OF ORIGINALS.

Both the Model 1911-380 and the 380 ACP cartridge are inventions of the legendary John M. Browning. The 380 ACP cartridge perfectly complements the 1911-380 because even with its reduced size, the pistol is slightly larger than the subcompact competition and easily accommodates the snappy caliber to provide manageable recoil and excellent accuracy.



E BLACK LABEL 1911-380 PRO



F BLACK LABEL 1911-380 PRO WITH RAIL



G BLACK LABEL 1911-380

FRAME Composite **SLIDE** Blackened stainless steel • **Matte black finish** **BARREL** Rust-resistant, 4-1/4" length • **Target crown** **ACTION** Locked-breech action • **Single-action trigger** **GRIPS** Pro models feature G-10 composite, Standard model includes composite panels **FEATURES** Pro models have steel three-dot combat sights or night sights dovetailed into slide, Standard model has fixed combat sights • Eight round magazine capacity • Extended, ambidextrous manual thumb safety • Extended slide release • Beavertail grip safety • Skeletonized hammer • ABS carry case included

NEW 2016	CA COMPLIANT	CALIBER	CODE NUMBER	SUGGESTED RETAIL	CAPACITY	SIGHTS	FINISH	GRIPS	BARREL LENGTH Inches	AVERAGE WEIGHT Oz.	OVERALL LENGTH Inches	SIGHT RADIUS Inches	MAGAZINES
BLACK LABEL 1911-380 PRO													
E	•	380 ACP	051900492	799.99	8	3-Dot	Matte Black	G-10	4-1/4	17-1/2	7-1/2	5-3/8	2
	•	380 ACP	051906492	879.99	8	Night Sights	Matte Black	G-10	4-1/4	17-1/2	7-1/2	5-3/8	2
BLACK LABEL 1911-380 PRO WITH RAIL													
	•	380 ACP	051901492	829.99	8	3-Dot	Matte Black	G-10	4-1/4	17-1/2	7-1/2	5-3/8	2
F	•	380 ACP	051907492	909.99	8	Night Sights	Matte Black	G-10	4-1/4	17-1/2	7-1/2	5-3/8	2
BLACK LABEL 1911-380													
G		380 ACP	051904492	669.99	8	Fixed	Matte Black	Composite	4-1/4	17-1/2	7-1/2	5-3/8	1

**INCLUDES
ABS CASE**





JARED WIHONGI

Jared Wihongi is a specialist in edged weapons and has more than 25 years of international martial arts experience. He also serves as a reserve SWAT officer not far from Browning headquarters in Utah. Jared has been instrumental in the development of the Black Label knife line. Learn more about him on page 310.

STILL THE STANDARD.

Few handguns have the reputation of the single-action Browning Hi Power. The Hi Power has earned its following for performance in the hands of law enforcement, military, special operations forces and law abiding citizens.

HI POWER

HI POWER FEATURES AND BENEFITS



FRAME AND SLIDE

- The frame and slide are built from solid steel to keep recoil light and manageable for accurate firing, even at a rapid rate. The Hi Power's balance in the hand is impeccable.



SIGHTS

- Hi Power pistols are available with fixed, low-profile three-dot sights. The Hi Power Standard is also available with optional low-profile target sights that are adjustable for windage and elevation.



MAGAZINE CAPACITY

- Double-stack magazine design.
- 13-round magazine capacity. 10-round capacity where required by law. Follow state and local laws regarding magazine capacity.



SAFETY

- A large, ambidextrous manual thumb safety is conveniently located on the frame just above the grip.

ALL BROWNING FIREARMS ARE SHIPPED WITH A FREE LOCKING DEVICE TO ASSIST IN THE SAFE STORAGE OF FIREARMS.



A HI POWER STANDARD



B HI POWER MARK III

INCLUDES ABS CASE

A HI POWER STANDARD

RECEIVER Steel • Polished blued finish **BARREL** 4-5/8" length • Polished blued finish on slide • Low profile fixed or adjustable rear sights with ramped front blade **ACTION** Locked breech • Single-action trigger • Ambidextrous thumb safety **GRIPS** Select walnut panels • Cut checkering **FEATURES** Extra magazine

B HI POWER MARK III

RECEIVER Steel • Black epoxy finish **BARREL** 4-5/8" length • Black epoxy on slide • Low profile fixed sights **ACTION** Locked breech • Single-action trigger • Ambidextrous thumb safety **GRIPS** Composite panels • Thumb rest **FEATURES** Extra magazine

NEW 2016 CA COMPLIANT	CALIBER	CODE NUMBER	SUGGESTED RETAIL	CAPACITY	SIGHTS	FINISH	GRIPS	BARREL LENGTH Inches	AVERAGE WEIGHT Oz.	OVERALL LENGTH Inches	SIGHT RADIUS Inches
HI POWER STANDARD											
	• 9mm	051003393	1,119.99	10	Fixed	Blued	Walnut	4-5/8	32	7-3/4	6-5/16
	9mm	051004393	1,119.99	13	Fixed	Blued	Walnut	4-5/8	32	7-3/4	6-5/16
A	• 9mm	051003493	1,199.99	10	Adj.	Blued	Walnut	4-5/8	32	7-3/4	6-1/2
	9mm	051004493	1,199.99	13	Adj.	Blued	Walnut	4-5/8	32	7-3/4	6-1/2
HI POWER MARK III											
B	• 9mm	051001393	1,109.99	10	Fixed	Matte Black	Molded Composite	4-5/8	32	7-3/4	6-5/16
	9mm	051002393	1,109.99	13	Fixed	Matte Black	Molded Composite	4-5/8	32	7-3/4	6-5/16



CAL 9 mm LUGER

MA
ASSEMBLED

GLOCK

CREATE AN EVERLASTING MASTERPIECE.

The Browning Custom Shop strives to meet the expectations of the individual, personalizing each aspect of a firearm from the wood to the engravings desired. Once the options are chosen, it is placed into the expert hands of highly skilled craftsmen that turn the dream of a gun into reality. Building a custom Browning firearm is an endeavor to be cherished.

The Custom Shop range comprises four grades, each of which includes a variety of options.



PRICE

- Pricing for the basic firearm, before custom enhancement, is available from the sales department at Browning in Morgan, Utah by calling (801) 876-2711. All prices are subject to change due to changing world currencies.

HOW TO BUILD A CUSTOM GUN

- Visit browning.com/custom to view or download the Browning Custom Shop brochure. In addition to showcasing the firearms available, this brochure displays and explains the many grades, engraving patterns, checkering patterns, stock and forearm designs and personal touches available.

HOW TO ORDER

- All inquiries for Custom Gun Shop products will be submitted to headquarters in Morgan, Utah. Once the basic specifications have been determined, a written order should be placed with the Morgan office. The specifications will be reviewed with the Custom Shop in Belgium, and a price and delivery date will be determined.

DELIVERY

- Actual production time will be based on the complexity and detail of the custom order. An approximate delivery date will be furnished with the factory cost quotation.



B25 SIDEPLATE TRAP

With a full sideplate design, the B25 Sporter is the epitome of over and under shotguns. This much appreciated model is generally configured with long barrels and a wide ventilated rib fitted with a mid-bead sight.



B25 SPORTER NEW GENERATION

In addition to an Olympic trigger, this model includes a tapered 5/16" - 7/16" top rib and ventilated side ribs. It is available in 30" and 32" barrel length versions. The adjustable stock is optional.

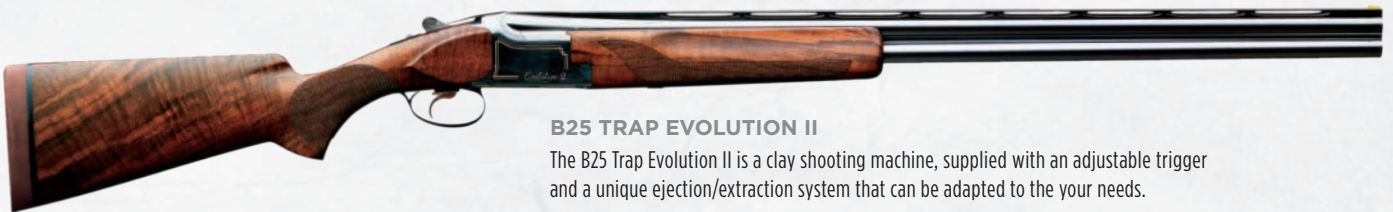

B25 TRAP EVOLUTION II

The B25 Trap Evolution II is a clay shooting machine, supplied with an adjustable trigger and a unique ejection/extraction system that can be adapted to the your needs.

ENGRAVINGS AVAILABLE FOR ALL CUSTOM SHOP MODELS



B25 B2G



B25 The Special



B25 C2G



B25 Diana



B25 D4G

THE EPITOME OF QUALITY.

Browning Custom Shop B25 shotguns are born in the hands of the exceptional craftsmen of Fabrique Nationale d’Herstal in Belgium. These unique models are meticulously made to order and move one step closer to perfection at every stage of the build. The finest assembly techniques, the beauty of detail and the love of firearms make these collections works of exceptional luxury.

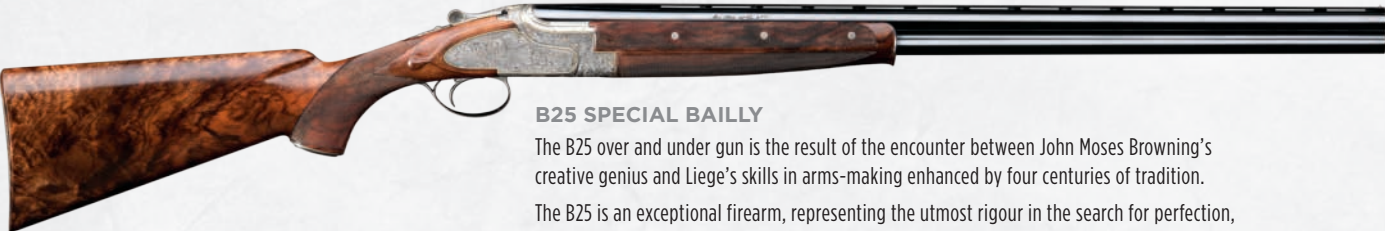

B25 SPECIAL BAILLY

The B25 over and under gun is the result of the encounter between John Moses Browning’s creative genius and Liege’s skills in arms-making enhanced by four centuries of tradition.

The B25 is an exceptional firearm, representing the utmost rigour in the search for perfection, and today it is the most refined and most admired over and under gun in the world.



B25 SPECIAL FLOWERS



B25 D5G SIDEPLATE

ENGRAVINGS AVAILABLE FOR ALL CUSTOM SHOP MODELS



B25 D5G



B25 Special Liben



B25 Cheverny



B25 C2S



B25 E1



B25 M1



B25 M2



B25 Special Partridge



B25 Windsor OR



B25 Chenonceau



B25 D5G Sideplate



B25 Ducks Galon



B25 At Rest



B25 Golden Covey



B25 Golden Feather

INDIVIDUAL FOR THE INDIVIDUAL.

To commemorate a special hunt or just to satisfy a long-held desire, a custom gun is readily tailored to meet your needs and dreams. To learn more, visit browning.com for descriptions of the unique, custom Browning firearms available.

**CCS 25 POUR SUITE**

The CCS 25 is elegance incarnate, available in sideplate and box-lock versions and in different calibers. This high-precision gun will be a faithful partner in every unforgettable hunting memory.

**375 H&H AFRICAN CLASSIC**

Custom Shop scope and mounts not included.

**C5**

Custom Shop scope and mounts not included.

MUCH MORE THAN A 22.

Rare is the rimfire rifle worthy of hand-wrought embellishment. When that rifle is an original design from The Master himself however, exceptions will be made. The John M. Browning designed SA-22 is an excellent foundation for a Custom Shop piece. The Grade III model shown is one of the most popular versions available with beautifully-finished gloss wood and an intricately engraved receiver.

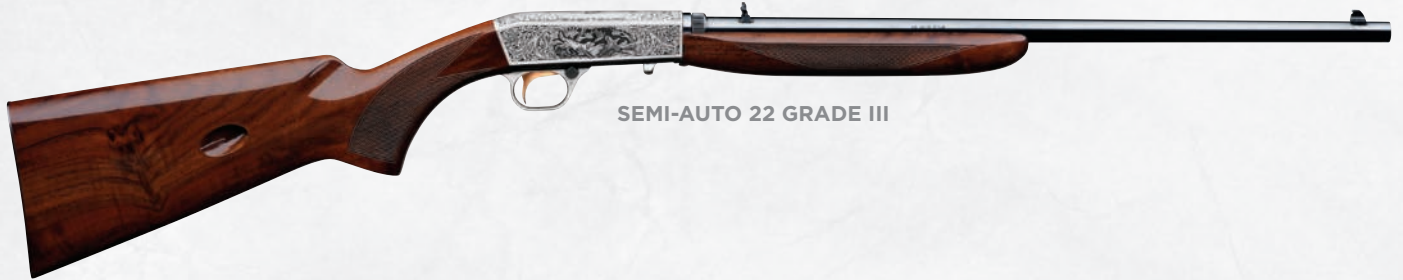

SEMI-AUTO 22 GRADE III

AN ENDURING MASTERPIECE.

A custom Browning Hi Power joins the legendary performance of one of the finest handguns the world has seen with the skill and craftsmanship found among the artisans of the Custom Shop.



HI POWER LUXUS 75TH ANNIVERSARY



HI POWER LUXUS
RENAISSANCE SILVER



HI POWER LUXUS
RENAISSANCE GOLD



BROWNING
PROSTEEL SAFES



**PROTECTION YOU
CAN BELIEVE IN.**

Whether you own a single pistol or a gun collection that could rival a small museum, securing your firearms inside the steel confines of a safe is a wise idea.

While many gun safes will secure your guns from unauthorized hands, a Browning ProSteel safe offers style, security, fire protection and storage solutions for real protection from determined criminals and the ravages of fire. Our unmatched interior configurations are the most versatile on the market, allowing you to store more of your guns and valuables.

Our wide selection includes safes for nearly every need and budget. Get a Browning ProSteel safe today and put your mind at ease.

SAFES



2-3 TIMES THE FIRE PROTECTION.

We understand that fire protection is more than just adding insulation to a safe, other aspects of safe construction play crucial roles in the total fire protection package. Here, the little details add up to make or break the true fire protection a safe offers. The thickness of the steel used in the body is vital. Heavier gauge steel flexes less when heated, limiting distortion that lets heat in through gaps in broken welds and around the door frame. Speaking of welds, we continuously weld every seam — not merely spot weld like some of the competition — for added resistance to heat-related flex. Even the no-gap external door hinge design matters. All of these little touches add up to big gains in fire and heat resistance, and go a long way towards protecting your most valuable possessions.

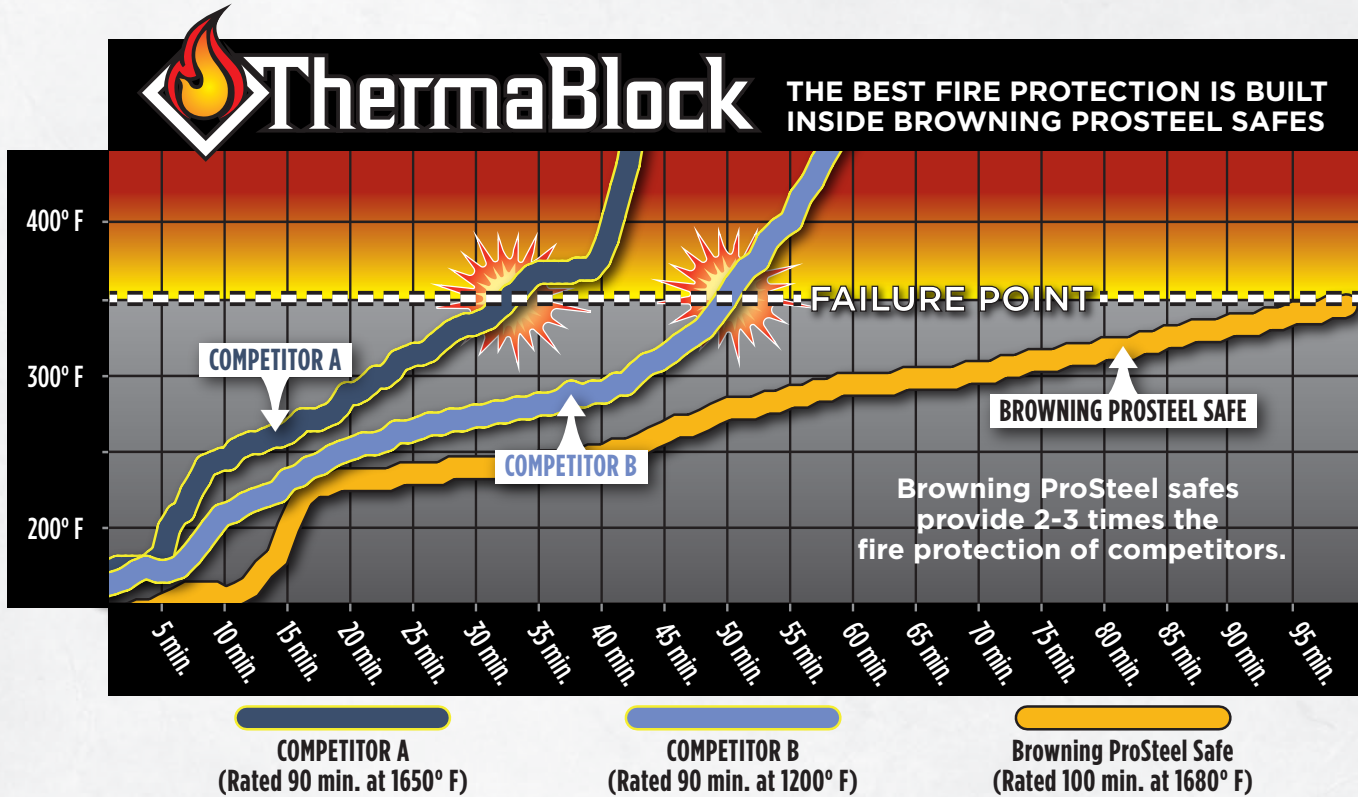

This graph compares a Browning ProSteel safe with ThermaBlock and external hinges to a pair of comparable safes from leading competitors with internal hinges.



Browning ProSteel safe with 1-7/8" thick insulation after 100 minutes at 1680°.



Leading U.S. built competitor safe with 1-7/8" thick insulation after 90 minutes at 1680°.

EXTERNAL HINGES MATTER.

External hinges offer several advantages over the internal hinges found on other safes, most notably in fire protection. To accommodate an internal hinge, fire protection material must be removed where the hinges attach. In a fire, these two unprotected areas allow the internal temperature of a safe to rise faster, to a significantly higher temperature than a Browning ProSteel safe with no gaps in the fire insulation.



OUR EXTERNAL HINGES
External hinges eliminate gaps in the fire insulation to block heat from entering the safe.



COMPETITORS' INTERNAL HINGE
Internal hinges allow up to eight times more heat to radiate inside the safe through gaps in the fire insulation.

BE MORE SECURE WITH A BROWNING PROSTEEL SAFE.

Protecting your guns and valuables from theft is one of the driving decisions behind purchasing a safe. Browning ProSteel safes offer industry-leading security measures at every level to protect your valuables from criminals.



PRY-STOP CORNER BOLTS
Pry-Stop Corner Bolts (U.S. patent #8,276,527) provide better protection than other pry-defense designs. Innovative long locking bolts extend diagonally from a reinforced support at the corners of the door to protect against pry attack at the vulnerable corner areas.



PRY-STOP END BOLTS
Superior to other bolt designs which allow the locking bolt support bar to bend. Pry-Stop End Bolts are over two and one-half times longer and attach to a high-strength steel angle iron that prevents the locking bolt support bar from bending in a pry attack. The top and bottom locking bolts on the door side secure the critical door corners.



PRY-STOP TABS
Pry-Stop Tabs are pieces of angled steel added to the top and bottom bolts and inside of the safe door. These reinforcements work together to increase pry resistance.



OMNIBARRIER® LOCK PROTECTION SYSTEM
A carefully engineered structure of steel hard plate and steel components designed to protect the safe lock from drill, punch and push attacks.



DUO-FORMED DOOR
The best Browning ProSteel safe door is made from multiple layers of steel formed together to provide superior strength, pry resistance and attack protection. Full second panel for outstanding strength. The door face is 1-11/16" thick.



1" FORMED DOOR
The 1" Formed Door is engineered with a rugged steel face. Back and reinforcement panels provide excellent strength and attack protection compared to the competition.



REINFORCED DOOR FRAME
The door opening of the safe is strengthened by an integrated return flange to create added pry and attack resistance.



UNI-FORCE™ LOCKING SYSTEM
The finest Browning ProSteel safe locking mechanism uses robust cam locks and a large, multiple diversion bar system to prevent bolt or handle pressure from reaching the lock. Forces go to the cams and diversion bars, not the lock, for protection unmatched by other locking systems.



FORCE DEFLECTOR™ LOCKING SYSTEM
The Force Deflector Locking System (U.S. patent #7,665,405) prevents bolt or handle forces from reaching the lock by using a rotating cam device. It prevents energy transfer to the lock better than most systems used in the safe industry.



180° HEAVY DUTY HINGES
Rugged hinges allow the door to swing open 180° for unhindered access to the safe interior. Door locking bolts maintain security if the hinges are cut off. Fire protection is better than with internal hinges because insulation is not removed to accommodate the hinges.



PRY-STOP END BOLTS



OMNIBARRIER® LOCK PROTECTION SYSTEM



PRY-STOP CORNER BOLTS

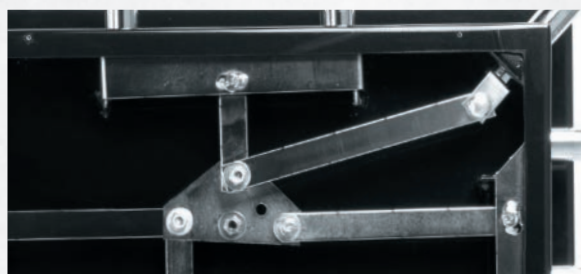

UNI-FORCE™ LOCKING SYSTEM

BETTER THAN THE REST.

Gun safes all look similar standing on a sales floor, but you won't find another that lives up to the high standards set by Browning. Our safes combine quality construction, proprietary technology and patented interior designs to elevate them above the rest. In addition to ground-breaking features, all Browning ProSteel safes carry the UL RSC (Underwriters Laboratories Residential Security Container) rating — the industry standard that defines a home security safe. The UL RSC rating ensures that a safe meets construction specifications and has passed a series of laboratory test attacks. Confidence in our product is what allows Browning and ProSteel to offer the best warranty in the gun safe industry — a lifetime warranty that covers attempted break in, break in, or fire. If one of our safes is involved in one of these situations and your homeowner's insurance policy does not cover the damage to the safe, ProSteel will repair or replace the safe. (Safe contents are not covered.)



THE BEST THERE IS FOR CONVENIENCE AND STORAGE SOLUTIONS.

A gun safe is more than total long gun capacity. Handguns, cameras, jewelry, documents, even laptops and external hard drives with thousands of digital memories should have a home inside. Browning ProSteel safes have the most versatile interiors in the industry, bar none.



ONE-OF-A-KIND AXIS ADJUSTABLE SHELVING

When it comes to maximizing safe interior storage, Browning ProSteel safes lead the industry with unmatched versatility. The exclusive Axis Adjustable Shelving (U.S. patent #D662341) is a completely customizable system with an array of shelves that can be configured to meet virtually every need. Unlike shelves in the competitors' safes that are either fixed in position or only offer vertical adjustment, Axis shelves can be adjusted up and down, side to side, added and removed to accommodate items over a broad range of sizes. Axis maximizes the interior storage of long guns, handguns and other valuables. Several different shelves and options are available to further customize the interior to meet specific needs. The Axis shelf is made from a single piece of sturdy steel. Shelves are clad in a soft, protective polymer coating that is highly durable and designed to protect guns and valuables. It also adds a sleek appearance to the safe interior. Axis accessories are designed to easily mount to the solid steel shelf or barrel rack. (Compatible with safes that feature Axis Adjustable Shelving built in 2013 or later. See page 134)



CANTILEVERED MODULAR SHELVING

Creative interior storage solutions don't end with Browning ProSteel Custom Collection models. Cantilevered Modular Shelving borrows essential components from the patented Axis Adjustable Shelving (U.S. patent #D662341) to retain much of the adjustability of the higher-end system. Like Axis, Cantilevered Modular shelves can be adjusted up and down, side to side, added and removed to fit a wide range of valuables. The shelves are wood covered in soft carpet and built upon a tough steel frame. Cantilevered Modular Shelving not only demolishes the competitors' offerings in similarly-priced gun safes, this versatile interior outclasses those in models costing thousands more.

UP TO 50% MORE LONG GUN STORAGE.



THE DPX ADVANTAGE

The patented DPX storage system (U.S. patent #7,409,790) is available exclusively on Browning ProSteel safes. This unequalled organizational tool allows long guns, handguns, shooting gear and more to be stored on the back of the safe door. The DPX gun rack creates as much as 50% more long gun capacity inside the safe, and makes the guns on the door easy to access. The Scope Saver increases storage and protects optics. DPX pouches and pockets hold valuables and gear where they are easy to find and free up shelf space for even more items.

CAPACITY COMPARISON	COMPETITOR'S SAFE 25-28 CUBIC FT. SAFE	BROWNING PROSTEEL SAFE 26 CUBIC FT. SAFE	RESULT
TOTAL GUN CAPACITY - HALF SHELF INTERIOR	12 Guns	18 Guns	50% More
TOTAL GUN CAPACITY - ALL GUN INTERIOR	24 Guns	29 Guns	21% More
FAST ACCESS GUNS - HALF SHELF INTERIOR	2 Guns	9 Guns	350% More
FAST ACCESS GUNS - ALL GUN INTERIOR	4 Guns	11 Guns	175% More

HOW DO BROWNING SAFES HOLD 50% MORE GUNS?

The long gun capacity is a series of three numbers, for example 11/22+7 for a 26 Cu. Ft. safe.

- The first number is the long gun capacity in the safe body with a Half Shelf interior (11 in the example).
- The second number is the long gun capacity in the safe body with an All Gun interior (22 in the example).
- The "plus" number is the long gun capacity on the back of the door (+7 in the example).
- Total capacity grows up to 50% in the Half Shelf configuration because there is a full rack of long guns on the door back.
- "Fast Access Guns" increase in both Half Shelf and All Gun configurations. These guns are defined as those that are on the front row of the safe body and the door gun rack and can be quickly accessed.

* Due to the varying sizes of firearms, actual gun capacity may vary.



THE QUICK ACCESS DPX BARREL RACK

Flexible polymer wings protect the barrel finish, secure the barrel in place and allow firearms to easily be pushed into or pulled from the rack. (U.S. patent #D643500)



MESH POCKETS

See-through mesh pockets hold smaller items and make valuables fast and easy to visually locate.



DPX HANDGUN POUCHES

The military-style MOLLE system straps on the DPX panel allow handgun pouches and other MOLLE items to be placed virtually anywhere.

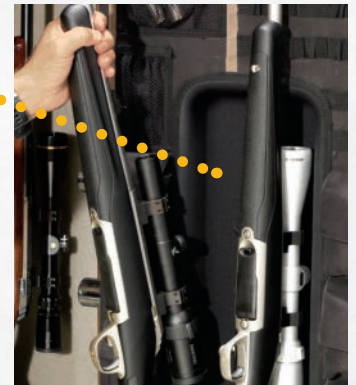

DPX SCOPE SAVER

Store long guns with optics on the DPX door rack with the Scope Saver. The recessed panel protects scopes and increases gun capacity.

PLATINUM PLUS SAFES

SECURITY Heavy duty 3/16" (7-Gauge) steel body • 1-11/16" Thick Duo-Formed® Door with full 10-Gauge inner plate • Uni-Force™ Locking System • OmniBarrier® Lock Protection System • Pry-Stop Corner Bolts • 1-1/2" diameter chromed locking bolts on all four sides of door (top/sides/bottom) **FIRE** ThermaBlock 1750° F/120 min. fire protection **APPEARANCE** Automotive grade gloss finish in your choice of color • Pinstriping and choice of graphic • Five-spoke handle in your choice of finishes • Grade VI Cedar paneling interior **CONVENIENCE** Premium DPX Storage System with Quick Access Barrel Rack and Scope Saver • Axis Adjustable Steel Shelving with Drawer and Multipurpose Insert, File Box and Pistol Rack • Elevated floor protects gun stocks • Electrical Outlet • Interior Light Package



A



A



B



C

WHY STEP UP TO A PLATINUM PLUS SAFE?

Stepping up to a Platinum Plus model gives you the advantage of an exquisite Grade VI Cedar interior for a unique appearance. Thicker 3/16" (7-Gauge) steel adds additional mass and rigidity, while larger (1-1/2") locking bolts and four corner locking bolts offer greater security and protection. A superior ThermoBlock 1750°/120 minute fire rating keeps valuables protected longer. An Axis Drawer with Multipurpose Insert and File Box are included. Platinum Plus safes are made in the USA.

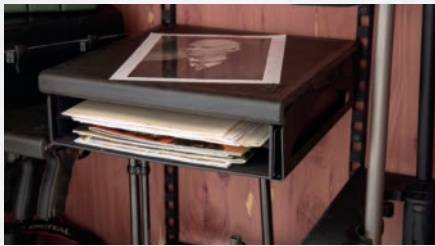

AXIS FILE BOX
Important documents may be irreplaceable and need to be easy to find. Keep track of them in the convenient File Box.



AXIS DRAWER AND MULTIPURPOSE INSERT
The Axis Drawer mounts beneath an Axis steel shelf and includes a Multipurpose Insert that keeps small items organized, easy to locate and protected.



GRADE VI INTERIOR/LED LIGHTING
A fragrant cedar interior adds a rich quality to the safe. Interior LED lighting along the door frame makes locating items inside the safe much easier.



ELECTRICAL OUTLET
The Electrical Outlet allows electrical accessories to be added without taking apart power cords.

**OPTIONS AVAILABLE:
(SEE PAGES 116-117 FOR DETAILS)**

NEW 2016	
LOCKS	
S&G Mechanical	
• S&G Top Lit Electronic	
SecuRam ScanLogic Biometric	
HARDWARE/TRIM COLORS	
Silver Chrome	
Black Chrome	
Gold	
GLOSS TWO-TONE FINISH COLORS	
• Midnight	
Steel Dawn	
Desert Smoke	
Crimson Fade	
GLOSS FINISH COLORS	
Black Cherry	
Black	
Hunter Green Metallic	
Titanium Metallic	
Charcoal Metallic	
Matte Black	
GRAPHICS	
Buckmark	
Elk	
Mule Deer	
Whitetail Buck/Doe	
Pointer	
Mallards	
Mountain	
Scroll	
No Scene	
NEW INK SERIES GRAPHICS	
• Rack	
• Flare	
• Flush	

NEW 2016	MODEL	PAINT FINISH	CODE NUMBER	SUGGESTED RETAIL	VOLUME	DIMENSIONS - EXTERIOR H x W x D inches	DIMENSIONS - INTERIOR H x W x D inches	WEIGHT Lbs.	LOCKING BOLTS Total/Active	TOTAL INSULATION Door/Body/Ceiling inches	STEEL THICKNESS Gauge	STANDARD SHELVES Quantity	BARREL RACKS Quantity	PISTOL RACKS Quantity	TOTAL LONG GUN CAPACITY Gun capacity may vary depending on gun sizes
A PLATINUM PLUS TALL EXTRA WIDE (SHOWN IN GLOSS BLACK CHERRY AND GLOSS MIDNIGHT TWO-TONE)															
	PP66	Two-Tone	1601100135	8,949.00	66	72x59x27	66x51x17	1920	28	2-3/8 • 3-1/8 • 2-1/2	7	12	4	2	59 (22/46+13)
		Gloss	1601100136	8,629.00											
B PLATINUM PLUS TALL WIDE (SHOWN IN GLOSS DESERT SMOKE TWO-TONE)															
	PP52	Two-Tone	1601100137	7,449.00	52	72x46x27	66x39x17	1620	28	2-3/8 • 3-1/8 • 2-1/2	7	8	3	1	43 (22/33+10)
		Gloss	1601100138	7,149.00											
C PLATINUM PLUS WIDE (SHOWN IN GLOSS CRIMSON FADE TWO-TONE)															
	PP43	Two-Tone	1601100139	6,699.00	43	60x46x27	54x39x17	1425	24	2-3/8 • 3-1/8 • 2-1/2	7	5	3	1	43 (22/33+10)
		Gloss	1601100140	6,379.00											



MEDALLION SAFES

SECURITY 10-Gauge steel body • 1-11/16" Thick Duo-Formed® Door with full 10-Gauge inner plate • Uni-Force™ Locking System • OmniBarrier® Lock Protection System • Pry-Stop Corner Bolts • 1-1/4" diameter chromed locking bolts on all four sides of door (top/sides/bottom) **FIRE** ThermoBlock 1700° F/110 min. fire protection **APPEARANCE** Automotive grade gloss or rugged textured finish • Pinstripping and choice of graphic • Five-spoke handle in choice of finishes • Beige fabric interior **CONVENIENCE** Premium DPX Storage System with Quick Access Barrel Rack and Scope Saver • Axis Adjustable Steel Shelving with Pistol Rack included • Elevated floor protects gun stocks • Electrical Outlet • Interior Light Package



WHY STEP UP TO A MEDALLION SAFE?

Stepping up to a Medallion safe buys extra security with Pry-Stop Corner Bolts, Uni-Force™ Locking System and OmniBarrier® Lock Protection System. Thicker steel (10-Gauge vs. 11-Gauge) means less flex. A higher fire rating (ThermaBlock 1700°/110 min. vs. 1680°/100 min.) is also a benefit. Medallion safes are made in the USA.



INTERIOR LIGHT PACKAGE
LED lighting adds even more value to the Medallion Series. A sensor turns on the lights when the door is opened.

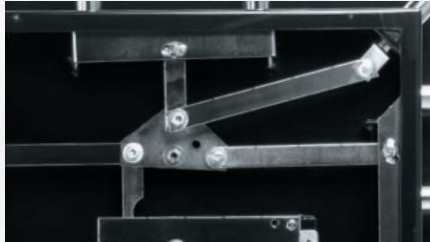

UNI-FORCE LOCKING SYSTEM
Robust cam locks and a multiple diversion bar system divert pressure from reaching the lock.



OMNIBARRIER LOCK PROTECTION
Steel hard plate surrounds the lock and protects it from drill, punch and push attacks.



ELECTRICAL OUTLET
The Electrical Outlet allows electrical accessories to be added without taking apart power cords.

PRY-STOP CORNER BOLTS
Innovative long bolts extend diagonally from the corners of the door to protect against pry attack at the vulnerable corner areas.

OPTIONS AVAILABLE:
(SEE PAGES 116-117 FOR DETAILS)

NEW 2016	LOCKS
	S&G Mechanical
	• S&G Top Lit Electronic
	SecuRam ScanLogic Biometric
	HARDWARE/TRIM COLORS
	Silver Chrome
	Black Chrome
	Gold
	GLOSS TWO-TONE FINISH COLORS
	• Midnight
	Steel Dawn
	Desert Smoke
	Crimson Fade
	GLOSS FINISH COLORS
	Black Cherry
	Black
	Hunter Green Metallic
	Titanium Metallic
	Charcoal Metallic
	Matte Black
	TEXTURED FINISH COLOR
Charcoal	
GRAPHICS	
Buckmark	
Elk	
Mule Deer	
Whitetail Buck/Doe	
Pointer	
Mallards	
Mountain	
Scroll	
No Scene	
NEW INK SERIES GRAPHICS	
• Rack	
• Flare	
• Flush	

NEW 2016	MODEL	PAINT FINISH	CODE NUMBER	SUGGESTED RETAIL	VOLUME	DIMENSIONS - EXTERIOR H x W x D inches	DIMENSIONS - INTERIOR H x W x D inches	WEIGHT lbs.	LOCKING BOLTS Total / Active	TOTAL INSULATION Door / Body / Ceiling inches	STEEL THICKNESS Gauge	STANDARD SHELVES Quantity	BARREL RACKS Quantity	PISTOL RACKS Quantity	TOTAL LONG GUN CAPACITY Gun capacity may vary depending on gun sizes
A MEDALLION TALL EXTRA WIDE (SHOWN IN GLOSS BLACK CHERRY WITH ELK GRAPHIC)															
	M62	Two-Tone	1601100141	5,899.00	62	72x57x26	66x51x17	1510	26	2-3/8 • 2-1/2 • 2-1/2	10	12	4	2	59 (22/46+13)
		Gloss	1601100142	5,559.00											
		Textured	1601100143	5,129.00											
B MEDALLION TALL WIDE (SHOWN IN GLOSS BLACK WITH MULE DEER GRAPHIC)															
	M48	Two-Tone	1601100144	5,129.00	48	72x44x26	66x39x17	1255	26	2-3/8 • 2-1/2 • 2-1/2	10	8	3	1	43 (22/33+10)
		Gloss	1601100145	4,799.00											
		Textured	1601100146	4,429.00											
C MEDALLION WIDE (SHOWN IN GLOSS CHARCOAL METALLIC WITH WHITETAIL BUCK/DOE GRAPHIC)															
	M40	Two-Tone	1601100147	4,599.00	40	60x44x26	54x39x17	1105	18	2-3/8 • 2-1/2 • 2-1/2	10	5	3	1	43 (22/33+10)
		Gloss	1601100148	4,299.00											
		Textured	1601100149	3,999.00											
D MEDALLION STANDARD (SHOWN IN GLOSS HUNTER GREEN WITH MOUNTAIN GRAPHIC)															
	M28	Two-Tone	1601100150	3,599.00	28	60x31x26	54x26x17	895	18	2-3/8 • 2-1/2 • 2-1/2	10	4	2	1	29 (11/22+7)
		Gloss	1601100151	3,299.00											
		Textured	1601100152	3,099.00											



SILVER SAFES

SECURITY 11-Gauge Steel Body • 1-11/16" Thick Duo-Formed® Door with full 10-Gauge inner plate • Force Deflector™ Locking System • Hardened steel pin lock protection • Pry-Stop End Bolts • 1-1/4" diameter chromed locking bolts on all four sides of door (top/sides/bottom) **FIRE** ThermoBlock 1680° F/100 min. fire protection **APPEARANCE** Automotive grade gloss or rugged textured finish • Pinstriping and choice of graphic • Five-spoke handle in choice of finishes • Beige fabric interior **CONVENIENCE** Premium DPX Storage System with Quick Access Barrel Rack and Scope Saver • Axis Adjustable Steel Shelving with Pistol Rack included • Elevated floor protects gun stocks • Electrical Outlet

NEW 2016



A

NEW 2016

MADE IN THE USA



A



B



C



D

WHY STEP UP TO A SILVER SAFE?

Stepping up to the Silver safe provides you with an elegant Five Spoke handle along with a full selection of finishes, colors and options to select from. Security is heightened thanks to the Duo-Formed door which features a full 10-Gauge inner plate. A higher fire rating (ThermaBlock 1680°/100 min. vs. 1680°/90 min.) and locking bolts on all four sides of the door improve protection from disaster. An Interior Light Package is included. Silver safes are made in the USA.



DPX SCOPE SAVER

Store long guns with optics on the DPX door rack with the Scope Saver. The recessed panel protects scopes and increases gun capacity.



AXIS ADJUSTABLE SHELVING

Multiple shelf styles are available and can be moved to allow small and large items to fit in the safe taking up minimum space.

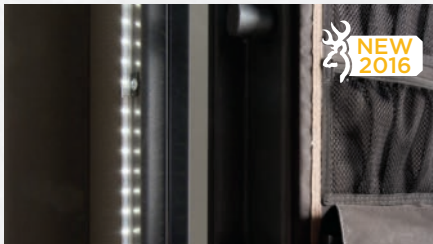

NEW INTERIOR LIGHT PACKAGE INCLUDED



ELECTRICAL OUTLET

The Electrical Outlet allows accessories to be added without taking apart power cords.

**OPTIONS AVAILABLE:
(SEE PAGES 116-117 FOR DETAILS)**

NEW 2016	
	LOCKS
	S&G Mechanical
	• S&G Top Lit Electronic
	SecuRam ScanLogic Biometric
	HARDWARE/TRIM COLORS
	Silver Chrome
	Black Chrome
	Gold
	GLOSS TWO-TONE FINISH COLORS
	• Midnight
	Steel Dawn
	Desert Smoke
	Crimson Fade
	GLOSS FINISH COLORS
	Black Cherry
	Black
	Hunter Green Metallic
	Titanium Metallic
	Charcoal Metallic
	Matte Black
	TEXTURED FINISH COLOR
	Charcoal
	GRAPHICS
	Buckmark
	Elk
	Mule Deer
	Whitetail Buck/Doe
	Pointer
	Mallards
	Mountain
	Scroll
	No Scene
	NEW INK SERIES GRAPHICS
	• Rack
	• Flare
	• Flush

NEW 2016	MODEL	PAINT FINISH	CODE NUMBER	SUGGESTED RETAIL	VOLUME	DIMENSIONS - EXTERIOR H x W x D inches	DIMENSIONS - INTERIOR H x W x D inches	WEIGHT Lbs.	LOCKING BOLTS Total/Active	TOTAL INSULATION Door/Body/Ceiling inches	STEEL THICKNESS Gauge	STANDARD SHELVES Quantity	BARREL RACKS Quantity	PISTOL RACKS Quantity	TOTAL LONG GUN CAPACITY Gun capacity may vary depending on gun sizes
A SILVER TALL EXTRA WIDE (SHOWN IN GLOSS CHARCOAL METALLIC WITH RACK GRAPHIC)															
	• SR59	Two-Tone	1601100219	4,999.00	59	72x56x25	66x51x17	1275	16/10	2-3/8 • 1-7/8 • 2-1/2	11	12	4	2	59 (22/46+13)
		Gloss	1601100220	4,699.00											
		Textured	1601100221	4,249.00											
B SILVER TALL WIDE (SHOWN IN GLOSS BLACK WITH BUCKMARK GRAPHIC)															
	SR45	Two-Tone	1601100153	4,199.00	45	72x43x25	66x39x17	1050	16/10	2-3/8 • 1-7/8 • 2-1/2	11	8	3	1	43 (22/33+10)
		Gloss	1601100154	3,879.00											
		Textured	1601100155	3,499.00											
C SILVER WIDE (SHOWN IN GLOSS TITANIUM METALLIC WITH FLARE GRAPHIC)															
	SR37	Two-Tone	1601100156	3,699.00	37	60x43x25	54x39x17	910	16/10	2-3/8 • 1-7/8 • 2-1/2	11	5	3	1	43 (22/33+10)
		Gloss	1601100157	3,379.00											
		Textured	1601100158	3,059.00											
D SILVER STANDARD (SHOWN IN GLOSS BLACK CHERRY WITH FLUSH GRAPHIC)															
	SR26	Two-Tone	1601100159	3,069.00	26	60x30x25	54x26x17	730	16/10	2-3/8 • 1-7/8 • 2-1/2	11	4	2	1	29 (11/22+7)
		Gloss	1601100160	2,749.00											
		Textured	1601100161	2,499.00											



OPTIONS AND ACCESSORIES FOR CUSTOM COLLECTION SAFES

Custom Collection safes offer a number of factory-installed options available. From color, to graphics, to hardware – it’s easy to order a safe just the way you want it.

FINISH COLORS

A GLOSS TWO-TONE MIDNIGHT

B GLOSS TWO-TONE STEEL DAWN

C GLOSS TWO-TONE DESERT SMOKE

D GLOSS TWO-TONE CRIMSON FADE

E GLOSS BLACK CHERRY

F GLOSS BLACK

G GLOSS HUNTER GREEN METALLIC

H GLOSS TITANIUM METALLIC

I GLOSS CHARCOAL METALLIC

J MATTE BLACK

K TEXTURED CHARCOAL

INTERIOR MATERIALS

L CEDAR PANELING

M BEIGE FABRIC

LOCKS

N S&G® MECHANICAL

The S&G® Mechanical Lock is the industry standard for security. Manufactured by the leader in the lock industry.

O S&G® TOP LIT ELECTRONIC

The S&G® Top Lit Electronic Lock is an advanced security system manufactured by the leader in the lock industry. Includes many technical security features. Now includes LED for easy access in the dark.

P SECURAM™ SCANLOGIC BIOMETRIC

The SecuRam™ ScanLogic Biometric Lock uses the uniqueness of an individual fingerprint as the combination in this advanced security solution. The lock opens with either a fingerprint or a multi-digit code. It is highly secure and operates very quickly.

HARDWARE AND TRIM COLORS

Q SILVER CHROME

R BLACK CHROME

S GOLD

NEW 2016	
GLOSS TWO-TONE FINISH COLORS	
A	• Midnight
B	Steel Dawn
C	Desert Smoke
D	Crimson Fade
GLOSS FINISH COLORS	
E	Black Cherry
F	Black
G	Hunter Green Metallic
H	Titanium Metallic
I	Charcoal Metallic
J	Matte Black
TEXTURED FINISH COLOR	
K	Charcoal

NEW 2016	
INTERIOR MATERIALS	
L	Cedar Paneling (Platinum Only)
M	Beige Fabric (Standard)
LOCKS	
N	S&G Mechanical
O	• S&G Top Lit Electronic
P	SecuRam ScanLogic Biometric
HARDWARE AND TRIM COLORS	
Q	Silver Chrome
R	Black Chrome
S	Gold

SAFE GRAPHICS

Safe graphics are permanently bonded to the safe door and can only be applied at the factory. Scroll is standard on Custom Collection safes, and the scenes below can be substituted for no extra charge. A “no scene” option is also available.



T BUCKMARK



U ELK
BY LEON PARSON



V MULE DEER
BY DAVID JACKSON



W WHITETAIL BUCK/DOE
BY LUKE FRAZIER



X POINTER
BY LUKE FRAZIER



Y MALLARDS
BY LUKE FRAZIER



Z MOUNTAIN
BY DAVID JACKSON

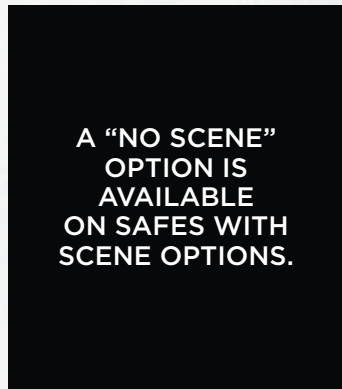

AA NO SCENE



BB SCROLL



CC RACK



DD FLUSH



EE FLARE

NEW 2016	
GRAPHICS	
T	Buckmark
U	Elk
V	Mule Deer
W	Whitetail Buck/Doe
X	Pointer

NEW 2016	
GRAPHICS	
Y	Mallards
Z	Mountain
AA	No Scene
BB	Scroll

NEW 2016	
NEW INK SERIES GRAPHICS	
CC	• Rack
DD	• Flush
EE	• Flare

HELL'S CANYON SAFE

SECURITY 11-Gauge steel body • 1" Formed Door with inner plate • Force Deflector™ Locking System • Hardened steel pin lock protection • Pry-Stop End Bolts • 1-1/4" diameter chromed locking bolts on three sides of door (top/sides) **FIRE** ThermoBlock 1680° F/90 min. fire protection **APPEARANCE** Rugged textured charcoal finish • Three-spoke black chrome handle • Beige fabric interior **CONVENIENCE** Premium DPX Storage System with Quick Access Barrel Rack and Scope Saver • Axis Adjustable Shelving with Pistol Rack included • Elevated floor protects gun stocks



A



HIGH CAPACITY BARREL RACK
The Hell's Canyon model puts a focus on long gun storage with a High Capacity Barrel Rack designed to provide instant access to 41 long guns (13 per rack).



AXIS ADJUSTABLE SHELVING
Multiple shelf styles are available and can be moved to allow small and large items to fit in the safe taking up minimal space.

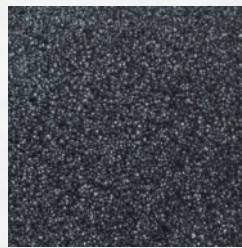

TEXTURED CHARCOAL



A

NEW 2016 MODEL	PAINT FINISH	GRAPHICS	HARDWARE	LOCK	CODE NUMBER	SUGGESTED RETAIL	VOLUME	DIMENSIONS - EXTERIOR H x W x D inches	DIMENSIONS - INTERIOR H x W x D inches	WEIGHT Lbs.	LOCKING BOLTS Total / Active	TOTAL INSULATION Door / Body / Ceiling inches	STEEL THICKNESS Gauge	STANDARD SHELVES Quantity	BARREL RACKS Quantity	PISTOL RACKS Quantity	TOTAL LONG GUN CAPACITY Gun capacity may vary depending on gun sizes	
A HELL'S CANYON EXTRA WIDE	HC48	Textured Charcoal	Hell's Canyon	Black Chrome	S&G Electronic	1601100162	3,259.00	48	60x55x25	55x52x17	1055	14/8	1-3/4 • 1-7/8 • 1-7/8	11	8	4	2	65 (39/52+13)
		Textured Charcoal	Hell's Canyon	Black Chrome	S&G Mechanical	1601100163	3,189.00											



THE BEAST SAFE

SECURITY 12-Gauge steel body • 1" Formed Door with partial inner plate • Force Deflector™ Locking System • Hardened steel pin lock protection • 1" diameter chromed locking bolts on three sides of door (top/sides) **FIRE** ThermoBlock 1400° F/60 min. fire protection **APPEARANCE** Matte Black finish • Three-spoke black chrome handle • Beige fabric interior **CONVENIENCE** DPX Storage System (top half of door back) • Cantilevered Modular Shelving • Elevated floor protects gun stocks



EXTRA CAPACITY.

Big gun collections need... you guessed it, a big safe. Add in a lifetime of other treasures and a safe will fill up fast. Browning ProSteel Extra Wide models have the space to secure more of whatever you need to load into one.

B



CANTILEVERED MODULAR SHELVING
Quickly and easily adjust the shelving to meet individual storage needs. Barrel racks can be adjusted at various heights to accommodate long guns, as well as shorter carbine models. The cantilevered design eliminates the need for a vertical shelf support to add extra interior space.

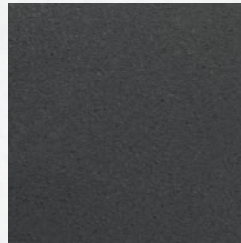

MATTE BLACK



B

NEW 2016	MODEL	PAINT FINISH	GRAPHICS	HARDWARE	LOCK	CODE NUMBER	SUGGESTED RETAIL	VOLUME	DIMENSIONS - EXTERIOR H x W x D Inches	DIMENSIONS - INTERIOR H x W x D Inches	WEIGHT Lbs.	LOCKING BOLTS Total / Active	TOTAL INSULATION Door / Body / Ceiling Inches	STEEL THICKNESS Gauge	STANDARD SHELVES Quantity	BARREL RACKS Quantity	PISTOL RACKS Quantity	TOTAL LONG GUN CAPACITY Gun capacity may vary depending on gun sizes
B THE BEAST EXTRA WIDE																		
•	BST40	Matte Black	The Beast	Black Chrome	SecuRam Electronic	1601100218	2,299.00	40	58x44x27	54x41x20	770	8/5	1 • 1 • 1-1/2	12	8	4	2	56 (22/46+10)
		Matte Black	The Beast	Black Chrome	S&G Mechanical	1601100217	2,229.00											



HUNTER SAFES

SECURITY 11-Gauge steel body • 1" Formed Door with inner plate • Force Deflector™ Locking System • Hardened steel pin lock protection • Pry-Stop End Bolts • 1-1/4" diameter chromed locking bolts on three sides of door (top/sides) **FIRE** ThermoBlock 1680° F/90 min. fire protection **APPEARANCE** Automotive grade gloss black or rugged textured charcoal finish • Pinstriping and decorative scroll work • Three-spoke silver chrome handle • Beige fabric interior **CONVENIENCE** Premium DPX Storage System with Quick Access Barrel Rack and Scope Saver • Axis Adjustable Shelving with Pistol Rack included • Elevated floor protects gun stocks



A



A



B

WHY STEP UP TO A HUNTER SAFE?

Stepping up to a Hunter safe adds a heavy 11-Gauge steel body and larger diameter locking bolts for greater security. A ThermaBlock 1680° F/90 min. rating elevates fire protection. Axis Adjustable Shelving adds convenience. These safes are made in the USA.



THE QUICK ACCESS DPX BARREL RACK
Flexible polymer wings protect the barrel finish, secure the barrel in place and allow firearms to easily be pushed into or pulled from the rack. (U.S. patent #D643500)



DPX SCOPE SAVER
Store long guns with optics on the DPX door rack with the Scope Saver. The recessed panel protects scopes and increases gun capacity.



MESH POCKETS
See-through mesh pockets hold smaller items and make contents fast and easy to visually locate.



AXIS ADJUSTABLE SHELVING
Multiple shelf styles are available and can be moved to allow small and large items to fit in the safe taking up minimal space.

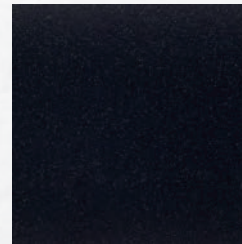

GLOSS BLACK

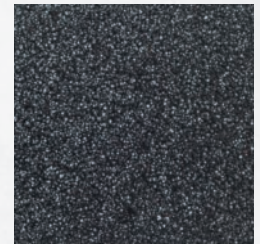

TEXTURED CHARCOAL

NEW 2016	MODEL	PAINT FINISH	GRAPHICS	HARDWARE	LOCK	CODE NUMBER	SUGGESTED RETAIL	VOLUME	DIMENSIONS - EXTERIOR H x W x D inches	DIMENSIONS - INTERIOR H x W x D inches	WEIGHT Lbs.	LOCKING BOLTS Total / Active	TOTAL INSULATION Door / Body / Ceiling Inches	STEEL THICKNESS Gauge	STANDARD SHELVES Quantity	BARREL RACKS Quantity	PISTOL RACKS Quantity	TOTAL LONG GUN CAPACITY Gun capacity may vary depending on gun sizes	
A HUNTER WIDE (SHOWN IN GLOSS BLACK)																			
	HR37	Gloss Black	Scroll	Silver Chrome	S&G Electronic	1601100164	3,199.00	37	60x43x25	55x39x17	875	14/8	1-3/4 • 1-7/8 • 1-7/8	11	5	3	1	43 (22/33+10)	
		Gloss Black	Scroll	Silver Chrome	S&G Mechanical	1601100165	3,129.00												
		Textured Charcoal	Scroll	Silver Chrome	S&G Electronic	1601100166	2,889.00												
		Textured Charcoal	Scroll	Silver Chrome	S&G Mechanical	1601100167	2,819.00												
B HUNTER STANDARD (SHOWN IN TEXTURED CHARCOAL)																			
	HR26	Gloss Black	Scroll	Silver Chrome	S&G Electronic	1601100168	2,529.00	26	60x30x25	55x26x17	700	14/8	1-3/4 • 1-7/8 • 1-7/8	11	4	2	1	29 (11/22+7)	
		Gloss Black	Scroll	Silver Chrome	S&G Mechanical	1601100169	2,459.00												
		Textured Charcoal	Scroll	Silver Chrome	S&G Electronic	1601100170	2,269.00												
		Textured Charcoal	Scroll	Silver Chrome	S&G Mechanical	1601100171	2,199.00												



HEAVYWEIGHT SAFES

SECURITY 11-Gauge steel body • 1" Formed Door with inner plate • Force Deflector™ Locking System • Hardened steel pin lock protection • Pry-Stop End Bolts • 1-1/4" diameter chromed locking bolts on three sides of door (top/sides) **FIRE** ThermoBlock 1550° F/80 min. fire protection
APPEARANCE Automotive grade gloss black or rugged textured charcoal finish • Decorative scroll work • Three-spoke black chrome handle
• Beige fabric interior **CONVENIENCE** Premium DPX Storage System with Quick Access Barrel Rack • Cantilevered Modular Shelving • Elevated floor protects gun stocks



A



A



B



C



D

OUT OF SIGHT
The HW16 features trim dimensions that make it ideal for placing into a closet to keep the safe hidden from curious eyes.

WHY STEP UP TO A HEAVYWEIGHT SAFE?

Stepping up to a Heavyweight safe adds a tough 11-Gauge steel body and Pry-Stop End Bolts for improved break-in protection. The excellent 1550° F/80 min. fire rating offers additional protection. A full DPX door storage rack adds storage for valuables, handguns and long guns, while improving access to more long guns. Black chrome hardware adds a rugged appearance.



QUICK ACCESS RACK

Flexible polymer wings secure the barrel and allow firearms to easily be pushed into or pulled from the rack.



PRY-STOP END BOLTS

More than two and one-half times longer than door bolts, they attach to angle iron which prevents the locking bolt support bar from bending in a pry attack. The top and bottom locking bolts on the door secure the critical door corners.



CANTILEVERED MODULAR SHELVING

Quickly and easily adjust the shelving to meet individual storage needs. Barrel racks can be adjusted at various heights to accommodate long guns, as well as shorter carbine models. The cantilevered design eliminates the need for a vertical shelf support to add extra interior space.



GLOSS BLACK

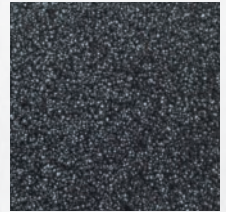

TEXTURED CHARCOAL

NEW 2016 MODEL	PAINT FINISH	GRAPHICS	HARDWARE	LOCK	CODE NUMBER	SUGGESTED RETAIL	VOLUME	DIMENSIONS - EXTERIOR H x W x D inches	DIMENSIONS - INTERIOR H x W x D inches	WEIGHT Lbs.	LOCKING BOLTS Total / Active	TOTAL INSULATION Door / Body / Ceiling inches	STEEL THICKNESS Gauge	STANDARD SHELVES Quantity	BARREL RACKS Quantity	TOTAL LONG GUN CAPACITY Gun capacity may vary depending on gun sizes
A HEAVYWEIGHT EXTRA WIDE (SHOWN IN GLOSS BLACK)																
HW41	Gloss Black	Heavyweight Logo	Black Chrome	SecuRam Electronic	1601100172	3,129.00	41	60x44x27	55x40x19	910	14/8	1-1/2 • 1-1/2 • 2	11	6	4	56 (22/46+10)
	Gloss Black	Heavyweight Logo	Black Chrome	S&G Mechanical	1601100173	3,059.00										
	Textured Charcoal	Heavyweight Logo	Black Chrome	SecuRam Electronic	1601100174	2,799.00										
	Textured Charcoal	Heavyweight Logo	Black Chrome	S&G Mechanical	1601100175	2,729.00										
B HEAVYWEIGHT WIDE (SHOWN IN TEXTURED CHARCOAL)																
HW34	Gloss Black	Heavyweight Logo	Black Chrome	SecuRam Electronic	1601100176	2,699.00	34	60x36x27	55x32x19	800	14/8	1-1/2 • 1-1/2 • 2	11	5	3	40 (20/30+10)
	Gloss Black	Heavyweight Logo	Black Chrome	S&G Mechanical	1601100177	2,629.00										
	Textured Charcoal	Heavyweight Logo	Black Chrome	SecuRam Electronic	1601100178	2,499.00										
	Textured Charcoal	Heavyweight Logo	Black Chrome	S&G Mechanical	1601100179	2,429.00										
C HEAVYWEIGHT STANDARD (SHOWN IN GLOSS BLACK)																
HW24	Gloss Black	Heavyweight Logo	Black Chrome	SecuRam Electronic	1601100180	1,969.00	24	60x30x23	55x26x16	610	14/8	1-1/2 • 1-1/2 • 2	11	4	2	25 (9/18+7)
	Gloss Black	Heavyweight Logo	Black Chrome	S&G Mechanical	1601100181	1,899.00										
	Textured Charcoal	Heavyweight Logo	Black Chrome	SecuRam Electronic	1601100182	1,859.00										
	Textured Charcoal	Heavyweight Logo	Black Chrome	S&G Mechanical	1601100183	1,789.00										
D HEAVYWEIGHT CLOSET (SHOWN IN TEXTURED CHARCOAL)																
HW16	Gloss Black	Heavyweight Logo	Black Chrome	SecuRam Electronic	1601100184	1,799.00	16	60x24x19	55x20x12	480	9/5	1-1/2 • 1-1/2 • 2	11	4	2	19 (7/14+5)
	Gloss Black	Heavyweight Logo	Black Chrome	S&G Mechanical	1601100185	1,729.00										
	Textured Charcoal	Heavyweight Logo	Black Chrome	SecuRam Electronic	1601100186	1,699.00										
	Textured Charcoal	Heavyweight Logo	Black Chrome	S&G Mechanical	1601100187	1,629.00										



SPORTER SAFES

SECURITY 12-Gauge steel body • 1" Formed Door with partial inner plate • Force Deflector™ Locking System • Hardened steel pin lock protection • 1" diameter chromed locking bolts on three sides of door (top/sides) **FIRE** ThermoBlock 1400° F/60 min. fire protection **APPEARANCE** Gloss black (SP33 & SP23 Only) or hammer gray finish • Three-spoke silver chrome handle • Beige fabric interior **CONVENIENCE** DPX Storage System (top half of door back) • Cantilevered Modular Shelving • Elevated floor protects gun stocks



A



QUICK ACCESS RACK

Flexible polymer wings secure the barrel and allow firearms to easily be pushed into or pulled from the rack.



CANTILEVERED MODULAR SHELVING

Quickly and easily adjust the shelving to meet individual storage needs. Barrel racks can be adjusted at various heights to accommodate long guns, as well as shorter carbine models. The cantilevered design eliminates the need for a vertical shelf support to add extra interior space.



A



B



C



D



E



F



OUT OF SIGHT

The SPI5 and SP9 feature trim dimensions that make them ideal for placing into a closet to keep them hidden from curious eyes.

WHY CHOOSE A SPORTER SAFE?

Sporter safes offer the quality, security and fire protection features expected from a Browning ProSteel gun safe at a price that is next to impossible to beat. The 1400° F/60 minute fire protection rating affords additional peace of mind. The Cantilevered Modular Interior and DPX door storage provide the most versatile interior found in a safe at this price — and above.

SPORTER COMPACT

- SECURITY 12-Gauge steel body • 1" formed steel door • Force Deflector™ Locking Mechanism • Hardened steel pin lock protection • 1" diameter chromed locking bolts • Heavy-duty 180° external hinges
- UL® tool attack listed FIRE ThermoBlock 1400° F/60 min. fire protection • Paluso® expanding fire seal • UL Type I Electronic Lock • Baked-on high-gloss finish • Beige two-shelf interior
- DPX Door Storage System

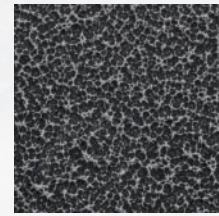

HAMMER GRAY



GLOSS BLACK

NEW 2016	MODEL	PAINT FINISH	GRAPHICS	HARDWARE	LOCK	CODE NUMBER	SUGGESTED RETAIL	VOLUME	DIMENSIONS - EXTERIOR H x W x D Inches	DIMENSIONS - INTERIOR H x W x D Inches	WEIGHT lbs.	LOCKING BOLTS Total / Active	TOTAL INSULATION Door / Body / Ceiling Inches	STEEL THICKNESS Gauge	STANDARD SHELVES Quantity	BARREL RACKS Quantity	TOTAL LONG GUN CAPACITY Gun capacity may vary depending on gun sizes	
A SPORTER TALL WIDE																		
•	SP41	Hammer Gray	Scroll	Silver Chrome	SecuRam Electronic	1601100222	2,449.00	41	72x36x27	68x33x20	770	8/5	1 • 1 • 1-1/2	12	8	3	40 (20/30+10)	
		Hammer Gray	Scroll	Silver Chrome	S&G Mechanical	1601100223	2,379.00											
B SPORTER WIDE (SHOWN IN HAMMER GRAY)																		
	SP33	Gloss Black	Scroll	Silver Chrome	SecuRam Electronic	1601100190	2,189.00	33	58x36x27	54x33x20	665	8/5	1 • 1 • 1-1/2	12	5	3	40 (20/30+10)	
		Gloss Black	Scroll	Silver Chrome	S&G Mechanical	1601100191	2,119.00											
		Hammer Gray	Scroll	Silver Chrome	SecuRam Electronic	1601100192	1,919.00											
		Hammer Gray	Scroll	Silver Chrome	S&G Mechanical	1601100193	1,849.00											
C SPORTER STANDARD (SHOWN IN GLOSS BLACK)																		
	SP23	Gloss Black	Scroll	Silver Chrome	SecuRam Electronic	1601100194	1,569.00	23	58x30x23	54x27x16	520	8/5	1 • 1 • 1-1/2	12	4	2	25 (9/18+7)	
		Gloss Black	Scroll	Silver Chrome	S&G Mechanical	1601100195	1,499.00											
		Hammer Gray	Scroll	Silver Chrome	SecuRam Electronic	1601100196	1,469.00											
		Hammer Gray	Scroll	Silver Chrome	S&G Mechanical	1601100197	1,399.00											
D SPORTER STANDARD																		
	SP20	Hammer Gray	Scroll	Silver Chrome	SecuRam Electronic	1601100198	1,319.00	20	58x30x20	54x27x13	495	8/5	1 • 1 • 1-1/2	12	4	2	23 (8/16+7)	
		Hammer Gray	Scroll	Silver Chrome	S&G Mechanical	1601100199	1,249.00											
E SPORTER CLOSET																		
•	SP15	Hammer Gray	Scroll	Silver Chrome	SecuRam Electronic	1601100224	1,099.00	15	58x24x19	53x20x12	410	8/5	1 • 1 • 1-1/2	12	4	2	19 (7/14+5)	
		Hammer Gray	Scroll	Silver Chrome	S&G Mechanical	1601100225	1,029.00											



F SPORTER COMPACT																		
	SP9	Gloss Black	Scroll	Silver Chrome	SecuRam Electronic	1601100200	1,199.00	9	30x24x20	26x21x16	280	6/3	1 • 1 • 1-1/2	12	2	N/A	N/A	



BLACK LABEL MARK IV SAFES

SECURITY 11-Gauge steel body • 1-5/16" Thick Duo-Formed® Door with full 10-Gauge inner plate • Force Deflector™ Locking System • Hardened steel pin lock protection • Pry-Stop End Bolts • 1-1/4" diameter chromed locking bolts on all four sides of door (top/sides/bottom) **FIRE** ThermoBlock 1680° F/100 min. fire protection **APPEARANCE** Matte black or NEW coyote tan finish with black chrome hardware and accents • Beige fabric interior **CONVENIENCE** Premium DPX Storage System with Quick Access Barrel Rack and Scope Saver • Two Carbine Barrel Loops • Axis Adjustable Steel Shelving with Pistol Rack included • Elevated floor protects gun stocks • Interior light package • Electrical Outlet



A

NEW 2016



B



C

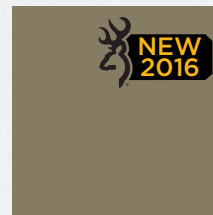

COYOTE TAN

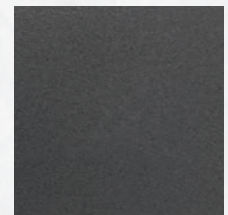

MATTE BLACK



AXIS ADJUSTABLE SHELVING

Multiple shelf styles are available and can be moved to allow small and large items to fit in the safe using the minimum amount of space. Individual shelves can be adjusted to accommodate modern sporting rifles, carbines and shotguns.



EXTERIOR GEAR LOFT

Tactical and hunting gear can be stored within easy reach on top of the safe in the semi enclosed Gear Loft.



AXIS PISTOL RACK

With a five handgun capacity, the pistol rack stores the pistols under the shelf, leaving the shelf available for possessions and gear.



CARBINE BARREL LOOPS

Lower mounted barrel loops secure shorter rifles and shotguns to the DPX door panel.



NEW 2016 MODEL	PAINT FINISH	GRAPHICS	HARDWARE	LOCK	CODE NUMBER	SUGGESTED RETAIL	VOLUME	DIMENSIONS - EXTERIOR H x W x D Inches	DIMENSIONS - INTERIOR H x W x D Inches	WEIGHT lbs.	LOCKING BOLTS Total/ Active	TOTAL INSULATION Door / Body / Ceiling Inches	STEEL THICKNESS Gauge	STANDARD SHELVES Quantity	BARREL RACKS Quantity	PISTOL RACKS Quantity	TOTAL LONG GUN CAPACITY Gun capacity may vary depending on gun sizes	
BLACK LABEL MARK IV WIDE (SHOWN IN MATTE BLACK AND COYOTE TAN)																		
A	US57	Matte Black	Shield	Black Chrome	S&G Electronic	1601100201	4,199.00	37	60x43x25	54x39x17	910	16/10	2-3/8 • 1-7/8 • 2-1/2	11	5	3	1	43 (22/33+10)
B	• US57	Coyote Tan	Shield	Black Chrome	S&G Electronic	1601100226	4,199.00											
C BLACK LABEL MARK IV STANDARD (SHOWN IN MATTE BLACK)																		
	US26	Matte Black	Shield	Black Chrome	S&G Electronic	1601100202	3,499.00	26	60x30x25	54x26x17	730	16/10	2-3/8 • 1-7/8 • 2-1/2	11	4	2	1	29 (11/22+7)
	• US26	Coyote Tan	Shield	Black Chrome	S&G Electronic	1601100227	3,499.00											



BLACK LABEL MARK III SAFES

SECURITY 12-Gauge steel body • 1" Formed Door with partial inner plate • Force Deflector™ Locking System • Hardened steel pin lock protection • 1" diameter chromed locking bolts on three sides of door (top/sides) **FIRE** ThermaBlock 1400° F/60 min. fire protection **APPEARANCE** Matte tactical black finish with black chrome hardware and accents • Beige fabric interior **CONVENIENCE** Full DPX Storage System • Two Carbine Barrel Loops • Cantilevered Modular Shelving • Elevated floor protects gun stocks



E



D



E

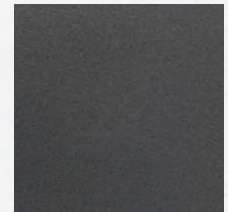

MATTE BLACK

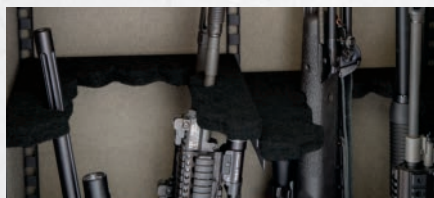

CANTILEVERED MODULAR SHELVING
Quickly and easily adjust the shelving to meet individual storage needs. Barrel racks can be adjusted at various heights to accommodate long guns, as well as shorter carbine models. The cantilevered design eliminates the need for a vertical shelf support to add extra interior space.



DPX STORAGE SYSTEM
Includes a rack on the back of the door to store long guns and make them easier to access. Pouches and pockets help organize other valuables.



CARBINE BARREL LOOPS
Lower mounted barrel loops secure shorter rifles and shotguns to the DPX door panel.

NEW 2016	MODEL	PAINT FINISH	GRAPHICS	HARDWARE	LOCK	CODE NUMBER	SUGGESTED RETAIL	VOLUME	DIMENSIONS - EXTERIOR H x W x D Inches	DIMENSIONS - INTERIOR H x W x D Inches	WEIGHT Lbs.	LOCKING BOLTS Total / Active	TOTAL INSULATION Door / Body / Ceiling Inches	STEEL THICKNESS Gauge	STANDARD SHELVES Quantity	BARREL RACKS Quantity	TOTAL LONG GUN CAPACITY Gun capacity may vary depending on gun sizes	
D BLACK LABEL MARK III WIDE																		
	MP33	Matte Black	Shield	Black Chrome	SecuRam Electronic	1601100203	2,449.00	33	58x36x27	54x33x19	665	8/5	1 • 1 • 1-1/2	12	5	3	40 (20/30+10)	
E BLACK LABEL MARK III STANDARD																		
	MP23	Matte Black	Shield	Black Chrome	SecuRam Electronic	1601100204	1,879.00	23	58x30x23	54x29x16	520	8/5	1 • 1 • 1-1/2	12	4	2	25 (9/18+7)	



SELECT SAFES

SECURITY 11-Gauge steel body • 1" Formed Door with inner plate • Force Deflector™ Locking System • Hardened steel pin lock protection • Pry-Stop End Bolts • 1" diameter chromed locking bolts on three sides of door (top/sides) **FIRE** ThermoBlock 1550° F/80 min. fire protection **APPEARANCE** Gloss Black or Hunter Green Metallic finish • Three-spoke handle • Beige Fabric interior

CONVENIENCE Full DPX Storage System • Cantilevered Modular Shelving • Elevated floor protects gun stocks



A



A



B



Select Series safes are available exclusively from Browning Full Line and Medallion Dealers.

WHY CHOOSE A SELECT SAFE?

A Select safe offers added security with Pry-Stop End Bolts and a big increase in convenience and capacity thanks to the Quick Access Rack with Scope Saver and full DPX Storage System. The factory-installed LED Interior Light package makes locating items inside the safe easy.



CANTILEVERED MODULAR SHELVING

Quickly and easily adjust the shelving to meet individual storage needs. Barrel racks can be adjusted at various heights to accommodate long guns, as well as shorter carbine models. The cantilevered design eliminates the need for a vertical shelf support to add extra interior space.



PRY-STOP END BOLTS

More than two and one-half times longer than standard door bolts, they attach to angle iron which prevents the locking bolt support bar from bending in a pry attack. The top and bottom locking bolts on the door side secure the critical door corners.



LED INTERIOR LIGHT PACKAGE

LED lighting around the door frame adds value and makes locating items in the safe easier. A pressure sensor turns on the lights when the door is opened.

**OPTIONS AVAILABLE:
(SEE PAGE 117 FOR DETAILS)**

NEW 2016	
	GRAPHICS
	Buckmark
	Elk
	Mule Deer
	Whitetail Buck/Doe
	Pointer
	Mallards
	Mountain
	Scroll
	No Scene
	INK SERIES GRAPHICS
	• Rack
	• Flare
	• Flush

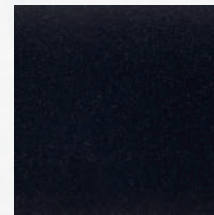

GLOSS BLACK

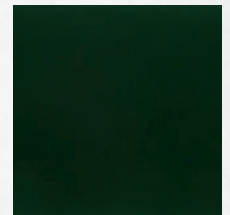

GLOSS HUNTER GREEN METALLIC

NEW 2016	MODEL	PAINT FINISH	HARDWARE	LOCK	CODE NUMBER	SUGGESTED RETAIL	VOLUME	DIMENSIONS - EXTERIOR H x W x D inches	DIMENSIONS - INTERIOR H x W x D inches	WEIGHT Lbs.	LOCKING BOLTS Total / Active	TOTAL INSULATION Door / Body / Ceiling Inches	STEEL THICKNESS Gauge	STANDARD SHELVES Quantity	BARREL RACKS Quantity	PISTOL RACKS Quantity	TOTAL LONG GUN CAPACITY Gun capacity may vary depending on gun sizes	
A SELECT WIDE (SHOWN IN GLOSS HUNTER GREEN METALLIC AND GLOSS BLACK WITH POINTER GRAPHIC)																		
	ST34	Gloss Black	Gold	SecuRam Electronic	1601100205	2,749.00	34	60x36x27	55x33x19	805	14/8	1-1/2 • 1-1/2 • 2	11	5	3	N/A	40 (20/30+10)	
		Gloss Black	Gold	S&G Mechanical	1601100206	2,679.00												
		Gloss Hunter Green Metallic	Gold	SecuRam Electronic	1601100207	2,749.00												
		Gloss Hunter Green Metallic	Gold	S&G Mechanical	1601100208	2,679.00												
B SELECT STANDARD (SHOWN IN GLOSS HUNTER GREEN METALLIC WITH MALLARD GRAPHIC)																		
	ST24	Gloss Black	Gold	SecuRam Electronic	1601100209	2,119.00	24	60x30x23	55x27x16	615	14/8	1-1/2 • 1-1/2 • 2	11	4	2	N/A	25 (9/18+7)	
		Gloss Black	Gold	S&G Mechanical	1601100210	2,049.00												
		Gloss Hunter Green Metallic	Gold	SecuRam Electronic	1601100211	2,119.00												
		Gloss Hunter Green Metallic	Gold	S&G Mechanical	1601100212	2,049.00												



UNIVERSAL VAULT DOOR

FEATURES Designed to fit a variety of wall types and installation requirements • Available with an out-swing or in-swing option • 1-5/16" thick Duo-Formed® door • 22, 1-1/4" chromed locking bolts • OmniBarrier® Lock Protection System • Uni-Force™ Locking System • 1-1/2" of fire-resistant insulation in the door • Knurled five-spoke Buckmark handle • External ball-bearing hinges • Palusol® expanding fire seal • Also available with a black primer finish that is ready to paint and match any decor • Internal lock release to open the door from within the vault

OUT-SWING SPECIFICATIONS The minimum rough door opening for the Out-Swing Vault Door is 83" x 36" • External L-frame with 1/2" diameter steel J-bolt anchors (included) can be poured in place in new construction or installed in an existing door frame by using expansion anchors or lag bolts (not included) • Door frame L-flange will fit any wall with a minimum thickness of 5-1/2"

IN-SWING SPECIFICATIONS The minimum rough door opening for the In-Swing Vault Door is 83-1/2" x 42" • Clamshell flange design uses an internal and external flange for additional security and improved appearance • Can be secured into an existing door frame using the clamshell flange or, for additional security, using expansion anchors or lag bolts (not included) • Clamshell flange has a 3-1/2" range of adjustment to fit walls with a minimum thickness of 4-1/2" to a maximum thickness of 7-1/4"



A



B



INTERNAL LOCK RELEASE

Allows the door to be opened from inside the vault to prevent accidentally being locked inside.

OPTIONS AVAILABLE:
(SEE PAGES 116-117 FOR DETAILS)

NEW 2016
LOCKS
S&G Mechanical
• S&G Top Lit Electronic
SecuRam ScanLogic Biometric
HARDWARE/TRIM COLORS
Silver Chrome
Black Chrome
Gold
GLOSS TWO-TONE FINISH COLORS
• Midnight
Steel Dawn
Desert Smoke
Crimson Fade
GLOSS FINISH COLORS
Black Cherry
Black
Hunter Green Metallic
Titanium Metallic
Charcoal Metallic
Matte Black
GRAPHICS
Buckmark
Elk
Mule Deer
Whitetail Buck/Doe
Pointer
Mallards
Mountain
Scroll
No Scene
NEW INK SERIES GRAPHICS
• Rack
• Flare
• Flush

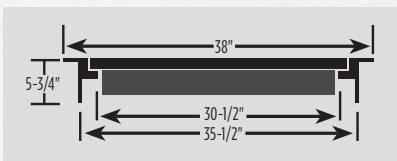

OUT-SWING DOOR DIMENSIONS - TOP VIEW

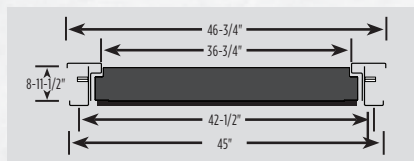

IN-SWING DOOR DIMENSIONS - TOP VIEW

NEW 2016	PAINT FINISH	CODE NUMBER	SUGGESTED RETAIL	DIMENSIONS - EXTERIOR H X W X D, inches	WEIGHT Lbs.	LOCKING BOLTS Total / Active	INSULATION LAYERS - DOOR 1/2" inch thick	STEEL THICKNESS Gauge
A UNIVERSAL VAULT DOOR OUT-SWING								
	Gloss	1601100075	3,819.00	83x36	645	22	3	7
	Primer	1601100076	3,689.00	83x36	645	22	3	7
B UNIVERSAL VAULT DOOR IN-SWING								
	• Gloss	1601100229	4,119.00	85x45	800	22	3	7
	• Primer	1601100228	3,999.00	85x45	800	22	3	7



SECURITY DOOR

FEATURES 1-7/8" thick Duo-Formed® type door • 1-1/4" chromed locking bolts • 1" of fire-resistant insulation in the door face • Residential interior straight brass handle • UL® Listed Type I Electronic Lock • Concealed hinges • Internal lock release to open the door from within the vault • Door swings out a full 180° when open • Minimum rough door opening is 83" x 36"



C

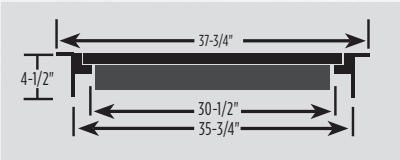

DOOR DIMENSIONS - TOP VIEW



NEW 2016	PAINT FINISH	CODE NUMBER	SUGGESTED RETAIL	DIMENSIONS - EXTERIOR H X W X D Inches	WEIGHT Lbs.	LOCKING BOLTS Total / Active	INSULATION LAYERS - DOOR 1/2 inch thick	STEEL THICKNESS Gauge
C SECURITY DOOR	Primer	1601100077	4,499.00	83x36	500	20/10	2	10



TOUGH, SAFE-LIKE SECURITY.

Whether keeping a handgun available for instant protection from bad guys or keeping valuables secure, trust a Browning ProSteel pistol vault. These feature-packed vaults have steel walls that are twice the thickness of most competitors and include safe-like security measures for superior protection from break in.

PISTOL VAULT FEATURES AND BENEFITS



ELECTRONIC 4-BUTTON TOUCH PAD

Easily program a personal code to offer ready access to handguns and small valuables. Uses eight AA batteries. (Not included.)



PICK AND PLUCK FOAM

A pick and pluck foam insert allows the pistol vault to be customized to fit firearms and other valuables. This feature is especially handy if the pistol vault is mounted in a vehicle.



LED LIGHTING

Bright LED lighting illuminates the interior, making it easy to locate the pistol vault's contents at night or in a closet.



LOCKING BOLTS

A pair of tough 1/2" diameter locking bolts secure the lid.



MANUAL KEY LOCK

Batteries go out? Forget the code? No problem. The pistol vault can still be accessed using the unique four-sided key.

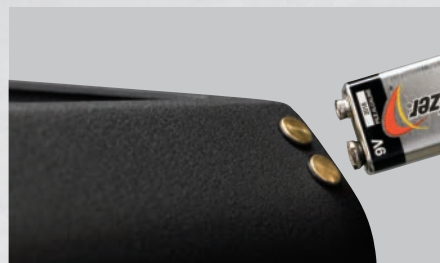

EXTERNAL ELECTRICAL CONTACTS

Should the batteries fail or if the key is lost, pistol vaults include external electrical contacts that power the touch pad. (9V back up battery not included.)



BIOMETRIC PAD

Grants instant access with the touch of a fingertip.





A



B



C

NEW 2016	MODEL	PAINT FINISH	CODE NUMBER	SUGGESTED RETAIL	DIMENSIONS - EXTERIOR H X W X D Inches	WEIGHT LBS.	LOCKING BOLTS Total / Above	STEEL THICKNESS Gauge
A	PISTOL VAULT 1500 BIOMETRIC							
	• PV1500	Textured Black	1601100233	439.00	9-1/2 x 14-1/2 x 11	28	2	10
	PISTOL VAULT 1500 (NOT SHOWN)							
	• PV1500	Textured Black	1601100230	289.00	9-1/2 x 14-1/2 x 11	28	2	10
	PISTOL VAULT 1000 BIOMETRIC (NOT SHOWN)							
	• PV1000	Textured Black	1601100231	399.00	7-1/2 x 14-1/2 x 11	25	2	10
B	PISTOL VAULT 1000							
	• PV1000	Textured Black	1601100133	249.00	7-1/2 x 14-1/2 x 11	25	2	10
C	PISTOL VAULT 500 BIOMETRIC							
	• PV500	Textured Black	1601100232	379.00	4-1/2 x 14-1/2 x 11	21	2	10
	PISTOL VAULT 500 (NOT SHOWN)							
	• PV500	Textured Black	1601100132	229.00	4-1/2 x 14-1/2 x 11	21	2	10





EXCLUSIVE, CUSTOMIZABLE, ADJUSTABLE SHELVING.

When it comes to maximizing safe interior storage, Browning ProSteel safes lead the industry with unmatched versatility. The exclusive Axis Adjustable Shelving (U.S. patent #D662341) uses an array of shelves that can be configured to meet virtually any need imaginable.



AXIS BOW HANGER
Lock up and protect expensive archery equipment while taking up minimal space.



AXIS SCOPED PISTOL RACK
With a deeper drop and heavy-gauge rods, handguns with optics are easier to store.



AXIS VERTICAL FILE HOLDER
This file holder makes it easier to locate and organize important documents.



AXIS DEEP DRAWER
The Deep Drawer is the perfect home for larger or odd shaped items.



AXIS HIGH CAPACITY BARREL RACK
Make room for more long guns with this high capacity barrel rack.



AXIS PISTOL RACK
With a five handgun capacity, the pistol rack stores the pistols under the shelf, leaving the shelf available for possessions and gear.



AXIS BARREL RACK
With 11 slots for long guns, the barrel rack can be raised or lowered to accommodate rifles, shotguns, carbines and modern sporting rifles.



AXIS STEEL SHELF
The most basic shelf is made from tough steel with a protective polymer skin that protects valuables and handguns.

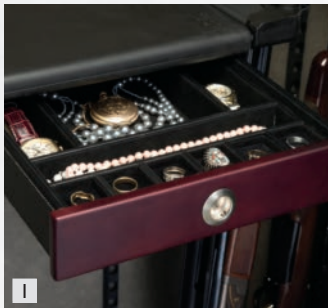

AXIS DRAWER WITH JEWELRY INSERT
This insert protects and organizes valuables such as watches, rings, bracelets and necklaces.



AXIS DRAWER WITH FOAM INSERT
Isolate your most prized possessions from potential damage. Pick and pluck foam is easily customized to fit any shape item.



AXIS DRAWER WITH MULTIPURPOSE INSERT
Keep delicate jewelry and other small items organized, protected and easy to find.



AXIS DRAWER WITH MONEY/PASSPORT INSERT
Compartments are sized to organize cash, passports and other documentation.



AXIS DRAWER
The sturdy drawer is perfect for all sorts of goods that need to be separated.



AXIS FILE BOX
Important documents may be irreplaceable or valuable or both. Keep them easy to find in this handy file box.

NEW 2016	DESCRIPTION	CODE NUMBER	SUGGESTED RETAIL
AXIS SHELVING			
A	Axis Bow Hanger	154117	30.00
B	Axis Scoped Pistol Rack	154118	19.00
C	Axis Vertical File Holder	154119	26.00
D	Axis Deep Drawer	154120	110.00
E	Axis High Capacity Barrel Rack	154114	32.00
F	Axis Pistol Rack	154102	19.00
G	Axis Barrel Rack	154101	34.00
H	Axis Steel Shelf	154100	36.00
I	Axis Drawer with Jewelry Insert	154108	80.00
J	Axis Drawer with Foam Insert	154109	80.00
K	Axis Drawer with Multipurpose Insert	154103	80.00
L	Axis Drawer with Money/Passport Insert	154113	80.00
M	Axis Drawer	154104	65.00
N	Axis File Box	154105	45.00

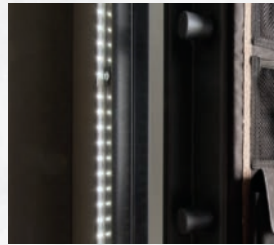
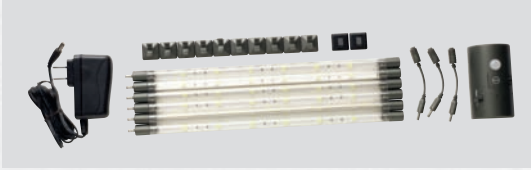

LED SAFE LIGHTING KIT

The LED Safe Lighting Kit is the best aftermarket lighting solution available today • The expandable, linear design places bright, long-lasting LED lighting anywhere in the safe • A motion sensor turns on the lights when the door opens and automatically shuts them off after 30 or 60 seconds with no motion or when the door closes • Each kit comes complete with six LED light tubes with six LEDs per tube, three flexible connectors, mounting clips with hook and loop tape, A/C adaptor and a motion sensor power module

CODE NUMBER	SUGGESTED RETAIL
164112	70.00

ZERUST VCI PROTECTANT

Small capsule emits an invisible vapor that forms a corrosion- and rust-resistant barrier on metal surfaces • Volatile Corrosion Inhibitors (VCIs) have been used for years to protect metal parts in industrial and commercial applications • One capsule protects a standard 30" wide safe for one year

CODE NUMBER	SUGGESTED RETAIL
154011	8.00

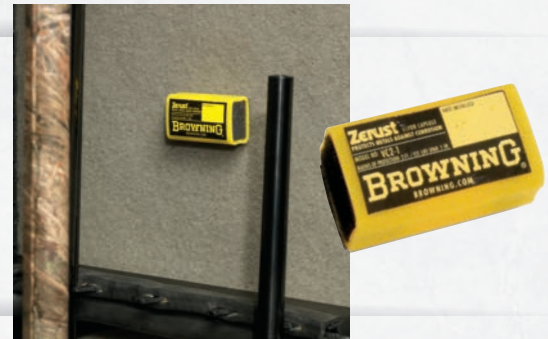

A



B



C

DPX ACCESSORIES

Take full advantage of the DPX storage system with these accessories • Store more guns without taking up shelf space with DPX Handgun Pouches (sold in sets of two) • Store shorter firearms and make them easily accessible with DPX barrel loops and DPX stock risers

	DESCRIPTION	CODE NUMBER	SUGGESTED RETAIL
A	Handgun Pouch	164138	30.00
B	Barrel Loop	164141	26.00
C	Stock Riser	164144	23.00

PISTOL RACK

Store handguns more efficiently • Increases storage space on shelves • Access to handguns is made easier by placing them in an upright position

	DESCRIPTION	CODE NUMBER	SUGGESTED RETAIL
A	6-Gun	164136	30.00
B	4-Gun	164134	20.00



A

B



VCI GUN SOCK

VCI (Vapor Corrosion Inhibitor) penetrates into the smallest crevices and drives out moisture where oils cannot reach • Provides full protection by forming a vapor enclosure around the firearm from muzzle to butt • Gives additional protection to all metal items in an enclosed area such as a gun safe or cabinet • Drawstring closure • Fits rifles and shotguns 48" to 56"

CODE NUMBER	SUGGESTED RETAIL
149985	18.00



DRY-ZONE MOISTURE REDUCER

Absorbs moisture without electricity, and is rechargeable in an oven • Can be reactivated indefinitely • One 500-gram box protects up to 37 cubic feet of enclosed space, about the volume of a standard 30" wide safe

CODE NUMBER	SUGGESTED RETAIL
154001	20.00



EVERDRY ELECTRIC DEHUMIDIFIER

The EverDry Electric Dehumidifier removes humidity from the interior of a safe and protects against rust • The 18" long EverDry should be used on safes 30" wide and larger • Cord is removable for installation

CODE NUMBER	SUGGESTED RETAIL
164128	30.00

FLEXIBLE EVERDRY DEHUMIDIFIER

The Flexible EverDry is flat and easily bends • Takes up less space and makes installation easier, especially in small safes • Removes humidity from the interior of a safe and protects against rust • Plug is removable for installation • LED indicates unit is operating

CODE NUMBER	SUGGESTED RETAIL
164129	40.00



S&G® ELECTRONIC LOCK RETROFIT KIT

The S&G Electronic Lock is an advanced security system manufactured by the leader in the lock industry • Includes many technical security features • Kit includes lock and installation DVD (Installation by a professional locksmith is recommended)

DESCRIPTION	CODE NUMBER	SUGGESTED RETAIL
(SHOWN IN SILVER CHROME)		
Silver Chrome	156034	160.00
Black Chrome	156035	
Gold	156036	



SECURAM™ SCANLOGIC BIOMETRIC LOCK RETROFIT KIT

The SecuRam ScanLogic Biometric Lock uses the uniqueness of an individual fingerprint as the combination in this advanced security solution • The lock opens with either a fingerprint or a multi-digit code • It is highly secure and operates very quickly • Simple programming instructions • LCD Screen (Installation by a professional locksmith is recommended)

DESCRIPTION	CODE NUMBER	SUGGESTED RETAIL
(SHOWN IN BLACK CHROME)		
Silver Chrome	156037	360.00
Black Chrome	156038	
Gold	156039	

		PLATINUM PLUS	MEDALLION	SILVER	HELL'S CANYON	HUNTER	HEAVYWEIGHT	THE BEAST	SPORTER	SPORTER COMPACT	BLACK LABEL MARK IV	BLACK LABEL MARK III	SELECT	
SECURITY														
STEEL BODY	THICKNESS GAUGE	7	10	11	11	11	11	12	12	12	11	12	11	
DOOR TYPE	DUO-FORMED	•	•	•	—	—	—	—	—	—	•	—	—	
	1" FORMED	—	—	—	•	•	•	•	•	•	—	•	•	
LOCKING SYSTEM	UNI-FORCE	•	•	—	—	—	—	—	—	—	—	—	—	
	FORCE DEFLECTOR	—	—	—	•	•	•	•	•	•	•	•	•	
LOCK PROTECTION	OMNIBARRIER	•	•	—	—	—	—	—	—	—	—	—	—	
	HARDENED STEEL PINS/RELOCKER	—	—	•	•	•	•	•	•	•	•	•	•	
LOCKING BOLTS	DIAMETER INCHES	1-1/2	1-1/4	1-1/4	1-1/4	1-1/4	1	1	1	1	1-1/4	1	1	
LOCKING BOLT LOCATION	DOOR TOP	•	•	•	•	•	•	•	•	—	•	•	•	
	DOOR SIDES	•	•	•	•	•	•	•	•	•	•	•	•	
	DOOR BOTTOM	•	•	•	—	—	—	—	—	—	•	—	—	
PRY-STOP BOLTS	TOTAL	Corner-4	Corner-2	End-2	End-2	End-2	End-2	Tabs	Tabs	Tabs	End-2	Tabs	Tabs	
LOCK OPTIONS	UL RATED BIOMETRIC	•	•	•	•	—	—	—	—	—	—	—	—	
	UL RATED ELECTRONIC	•	•	•	•	•	•	•	•	•	•	•	•	
	UL RATED MECHANICAL	•	•	•	•	•	•	•	•	—	—	—	•	
UL SECURITY LISTING	RSC TOOL ATTACK	•	•	•	•	•	•	•	•	•	•	•	•	
FIRE														
TEMPERATURE RATING	DEGREES FAHRENHEIT	1750	1700	1680	1680	1680	1550	1400	1400	1400	1680	1400	1550	
	MINUTES	120	110	100	90	90	80	60	60	60	100	60	80	
INSULATION	BODY (TOTAL THICKNESS IN INCHES)	3-1/8	2-1/2	1-7/8	1-7/8	1-7/8	1-1/2	1	1	1	1-7/8	1	1-1/2	
	CEILING (TOTAL THICKNESS IN INCHES)	2-1/2	2-1/2	2-1/2	1-7/8	1-7/8	2	1-1/2	1-1/2	1-1/2	2-1/2	1-1/2	2	
	DOOR (TOTAL THICKNESS IN INCHES)	2-3/8	2-3/8	2-3/8	1-3/4	1-3/4	1-1/2	1	1	1	2-3/8	1	1-1/2	
STORAGE														
DOOR	DPX	•	•	•	•	•	•	1/2	1/2	•	•	•	•	
	QUICK ACCESS DOOR RACK	•	•	•	•	•	•	•	•	—	•	•	•	
	SCOPE SAVER	•	•	•	•	•	—	—	—	—	•	—	•	
HANDGUN POUCHES	TOTAL	2	2	2	2	2	2	—	—	—	2	2	2	
INTERIOR	AXIS ADJUSTABLE SHELVING	•	•	•	•	•	—	—	—	—	•	—	—	
	CANTILEVERED MODULAR SHELVING	—	—	—	—	—	•	•	•	—	—	•	•	
	TWO SHELVES	—	—	—	—	—	—	—	—	—	•	—	—	
ADDITIONAL	AXIS DRAWER	•	—	—	—	—	—	—	—	—	—	—	—	
	MULTIPURPOSE INSERT	•	—	—	—	—	—	—	—	—	—	—	—	
	PISTOL RACK (5 GUN)	•	•	•	•	•	—	—	—	—	•	—	—	
APPEARANCE														
COLORS	TWO-TONE MIDNIGHT	•	•	•	—	—	—	—	—	—	—	—	—	
	TWO-TONE STEEL DAWN	•	•	•	—	—	—	—	—	—	—	—	—	
	TWO-TONE DESERT SMOKE	•	•	•	—	—	—	—	—	—	—	—	—	
	TWO-TONE CRIMSON FADE	•	•	•	—	—	—	—	—	—	—	—	—	
	GLOSS BLACK CHERRY	•	•	•	—	—	—	—	—	—	—	—	—	
	GLOSS BLACK	•	•	•	—	•	•	—	••	•	—	—	•	
	GLOSS HUNTER GREEN METALLIC	•	•	•	—	—	—	—	—	—	—	—	•	
	GLOSS TITANIUM METALLIC	•	•	•	—	—	—	—	—	—	—	—	—	
	GLOSS CHARCOAL METALLIC	•	•	•	—	—	—	—	—	—	—	—	—	
	MATTE BLACK	•	•	•	—	—	—	—	•	—	—	•	•	
	COYOTE TAN	—	—	—	—	—	—	—	—	—	—	•	—	
	TEXTURED CHARCOAL	—	•	•	•	•	•	—	—	—	—	—	—	
	HAMMER GRAY	—	—	—	—	—	—	—	—	•	—	—	—	
INTERIOR COVERING	GRADE VI CEDAR	•	—	—	—	—	—	—	—	—	—	—	—	
	BEIGE FABRIC	—	•	•	•	•	•	•	•	•	•	•	•	
HARDWARE/TRIM COLOR	5-SPOKE SILVER CHROME	•	•	•	—	—	—	—	—	•	—	—	—	
	5-SPOKE GOLD	•	•	•	—	—	—	—	—	—	—	—	—	
	5-SPOKE BLACK CHROME	•	•	•	—	—	—	—	—	—	—	—	—	
	3-SPOKE SILVER CHROME	—	—	—	—	•	—	—	•	—	—	—	—	
	3-SPOKE GOLD	—	—	—	—	—	—	—	—	—	—	—	•	
	3-SPOKE BLACK CHROME	—	—	—	•	—	•	•	—	—	—	—	—	
	TACTICAL BLACK CHROME	—	—	—	—	—	—	—	—	—	•	•	—	
GRAPHICS	BUCKMARK	•	•	•	—	—	—	—	—	—	—	—	•	
	ELK	•	•	•	—	—	—	—	—	—	—	—	•	
	MULE DEER	•	•	•	—	—	—	—	—	—	—	—	•	
	WHITETAIL BUCK/DOE	•	•	•	—	—	—	—	—	—	—	—	•	
	POINTER	•	•	•	—	—	—	—	—	—	—	—	•	
	MALLARDS	•	•	•	—	—	—	—	—	—	—	—	•	
	MOUNTAIN	•	•	•	—	—	—	—	—	—	—	—	•	
	SCROLL	•	•	•	—	•	•	—	•	•	—	—	•	
	NO GRAPHIC	•	•	•	—	—	—	—	—	—	—	—	•	
	INK SERIES - RACK	•	•	•	—	—	—	—	—	—	—	—	•	
	INK SERIES - FLARE	•	•	•	—	—	—	—	—	—	—	—	•	
INK SERIES - FLUSH	•	•	•	—	—	—	—	—	—	—	—	•		



**THE BEST IN OUTDOOR
ACCESSORIES COME
FROM BROWNING.**

Browning accessories offer avid outdoor enthusiasts innovative designs, robust materials and the highest quality workmanship to create products that will deliver years of service and satisfaction.

Don't take a chance on being disappointed during your next outdoor adventure by compromising on second-rate gear. Insist that all of your outdoor accessories have Browning on the label.

OUTDOOR
GEAR
XO[®]



A

JOHN M. BROWNING SIGNATURE LEATHER

SHELL Solid wood frame • Top grain Crazy Horse distressed leather cover with top grain aniline dyed latigo leather trim • John M. Browning signature patch • Leather security straps with brass buckles
PADDING TYPE Wool-lined interior with removable support blocks to adjust fit **HINGES** Three solid brass
LATCH Two brass combination locks **SPECIAL FEATURES** Molded thick leather full grip handle and leather corner accents • Accessory compartment with magnetized choke tube holders (will not hold titanium choke tubes) • Leather luggage tag • Firearms and accessories shown not included

CRAZY HORSE DISTRESSED LEATHER

SHELL Solid wood frame covered with durable Crazy Horse distressed leather **PADDING TYPE** Plush wool interior with removable support blocks to adjust fit **HINGE** Three solid brass **LATCH** Two brass combination locks **SPECIAL FEATURES** Thick leather handle and leather end caps • Accessory compartment with six choke tube slots • Firearms and accessories shown not included

B



C

CATLEMEN

SHELL Solid wood frame • Top grain Crazy Horse distressed leather end patch • Contrasting genuine soft suede covering • Crazy Horse distressed leather security strap with brass buckle
PADDING TYPE Wool-lined interior with removable support blocks to adjust fit • 3-D divider design maximizes interior storage space **HINGES** Continuous leather hinge **LATCH** Two brass combination locks
SPECIAL FEATURES Sewn leather full grip handle • Accessory compartment • Interior hook and loop strap secures receiver to prevent movement • Firearms and accessories shown not included

HIGH GRADE CANVAS UNIVERSAL

SHELL Solid wood frame • Canvas covered with heavy high-grade leather on borders, handle and fastening straps **PADDING TYPE** Soft wool lining **HINGES** Three solid brass **LATCH** Two solid brass combination locks **SPECIAL FEATURES** Polished brass fittings • Buckmark logo stamped on leather patches on the inside and outside • Leather trim • Accessory compartment • Firearms and accessories shown not included

D



E

LEATHER/CANVAS UNIVERSAL

SHELL Solid wood frame • Canvas covered • Full-grain reinforced leather trim **PADDING TYPE** Soft wool lining with movable padded support blocks **HINGES** Three solid brass **LATCH** Two brass combination locks and adjustable leather straps **SPECIAL FEATURES** Embroidered Browning logo inside lid • Firearms and accessories shown not included
DOES NOT FIT BT-100



F

CHESAPEAKE

SHELL Solid wood frame • Black vinyl cover with alligator-pattern brown vinyl trim on borders and handle
PADDING TYPE Soft wool lining • Elastic retainers for four choke tubes • Compartment for shooting glasses and gloves
HINGES Three solid brass **LATCH** Two solid brass latches **SPECIAL FEATURES** Polished brass fittings • Buckmark logo stamped on oval brass plaque on the outside • Firearms and accessories shown not included

CANVAS OVER/UNDER

SHELL Solid wood frame covered with canvas **PADDING TYPE** Soft wool lining **HINGES** Three brass **LATCH** Two brass combination locks **SPECIAL FEATURES** Leather corner accents • Thick leather handle • Firearms and accessories shown not included **DOES NOT FIT CITIORI XS SKEET OR TRAP**



G



H

PIEDMONT

SHELL Solid wood frame with cotton canvas covering and synthetic leather end patch • Contrasting 3D embroidered Buckmark **PADDING TYPE** Wool-lined interior with removable support blocks to adjust fit • 3-D divider design maximizes interior storage space **HINGE** Full-length sewn **LATCH** Two combination locks **SPECIAL FEATURES** Sewn leather full grip handle • Accessory compartment • Interior hook and loop strap secures receiver to prevent movement • Firearms and accessories shown not included

ENCINO II

SHELL Solid wood frame • Black pebble-grained simulated leather covered with contrasting brown simulated leather on ends and bottom **PADDING TYPE** Soft synthetic suede lining **HINGES** Three solid brass **LATCH** Two solid brass combination locks **SPECIAL FEATURES** Sewn leather full grip handle • Accessory compartment • Interior hook and loop strap secures receiver to prevent movement • Firearms and accessories shown not included



I

	DESCRIPTION	CODE NUMBER	SUGGESTED RETAIL	DIMENSIONS - W x D x H inches	STOCK/RECEIVER CAPACITY	BARREL CAPACITY	HOLDS BT STYLE GUNS	HOLDS OVER/UNDER STYLE GUNS	HOLDS AUTO/PUMP STYLE GUNS	HOLDS GUNS WITH EXTENDED CHOKE TUBES INSTALLED Maximum inches	RIFLE CASE	MAXIMUM BARREL LENGTH inches
A	JOHN M. BROWNING SIGNATURE LEATHER											
	Leather/Brown	1428798208	619.99	35-1/4 x 10 x 4-1/2	1	1	Y	Y	N	32 +	—	32
B	CRAZY HORSE DISTRESSED LEATHER											
	Brown	1424208408	599.99	36-7/8 x 10-5/8 x 4	1	1	Y	Y	N	34 +	—	34
C	CATTLEMEN											
	Leather/Brown Suede	1428328212	479.99	33-7/8 x 8-3/4 x 3-1/2	1	1	Y	Y	N	32 +	—	32
D	HIGH GRADE CANVAS UNIVERSAL											
	Sage/Tan	1424504408	409.99	36-7/8 x 10-5/8 x 4	1	1	Y	Y	N	34 +	—	34
E	LEATHER/CANVAS UNIVERSAL											
	Charcoal/Brown	1426129408	349.99	36-3/4 x 10-1/2 x 4-3/4	1	1	N	Y	N	34 +	—	34
F	CHESAPEAKE											
	Black/Brown	1427049408	299.99	35-3/4 x 9-3/4 x 2-3/4	1	1	Y	Y	N	34 +	—	34
G	CANVAS OVER/UNDER											
	Green/Olive	142510	269.99	34-3/8 x 9-5/8 x 3-11/16	1	1	N	Y	N	—	—	32
H	PIEDMONT											
	Clay/Brown	1428338212	219.99	33-7/8 x 8-3/4 x 3-1/2	1	1	Y	Y	N	32 +	—	32
I	ENCINO II											
	Black/Brown	1425039212	229.99	33-7/8 x 8-3/4 x 3-1/2	1	1	Y	Y	N	32 +	—	32

TRADITIONAL, TASTEFUL PROTECTION FOR EVERY CLASSIC BROWNING.

A Browning fitted case speaks eloquently of great traditions and good taste, being constructed of solid wood with brass fittings and the look of aged leather. These cases create the perfect backdrop for showing off a fine Browning firearm. Fitted gun cases provide a place for everything from choke tubes to shooting gloves and are designed to provide decades of tasteful protection for the valuable and classic Browning nested within.



A



B

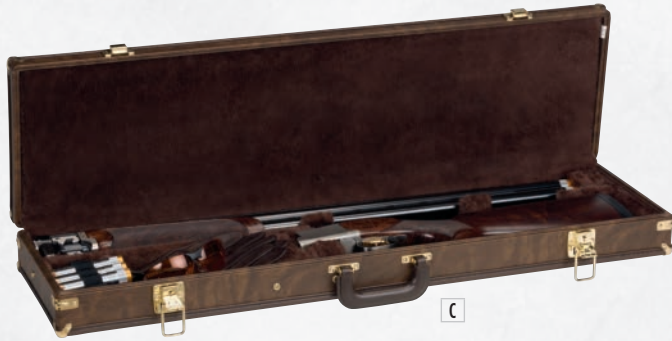

C



D



CLASSIC BROWN



BLACK/TAN

TRADITIONAL

SHELL Rugged wood construction covered with expanded vinyl **PADDING TYPE** Deep pile fleece with fabric-covered positioning blocks **HINGES** Three brass-plated **LATCH** One or two key locks
SPECIAL FEATURES Brass corner accents • Folding molded handle • Accessory compartment • Firearms and accessories shown not included ***DOES NOT FIT CITIORI TRAP OR SKEET**

DESCRIPTION	CODE NUMBER	SUGGESTED RETAIL	COLOR	DIMENSIONS W x D x H inches	STOCK/RECEIVER CAPACITY	BARREL CAPACITY	HOLDS BT STYLE GUNS	HOLDS OVER/UNDER STYLE GUNS	HOLDS AUTO/PUMP STYLE GUNS	HOLDS GUNS WITH EXTENDED CHOKE TUBES INSTALLED Maximum inches	RIFLE CASE	MAXIMUM BARREL LENGTH Inches
A BT-Style Single Barrel Trap	142810	279.99	Classic Brown	35-1/2 x 8-1/4 x 3-3/4	1	1	Y	N	N	—	N	34
BT-Style Single Barrel	1428119410	289.99	Black/Tan	35-1/2 x 8-3/4 x 3-3/4	1	1	Y	N	N	—	N	34
B Auto/Pump Shotgun	142821	319.99	Classic Brown	35-1/2 x 10-1/2 x 3-3/4	1	2	N	N	Y	—	N	32
C Universal Over/Under, BT Trap	1428118408	289.99	Classic Brown	35-1/2 x 9 x 3-1/2	1	1	Y	Y	N	34 +	N	34
Universal Over/Under, BT Trap	1428119408	289.99	Black/Tan	35-1/2 x 9 x 3-1/2	1	1	Y	Y	N	34 +	N	34
Over/Under Shotgun*	142841	269.99	Classic Brown	33 x 8-5/8 x 3	1	1	N	Y	N	—	N	32
Over/Under Shotgun*	142840	249.99	Classic Brown	31 x 8-5/8 x 3	1	1	N	Y	N	—	N	30
Over/Under Shotgun for Citori Trap or Skeet	142880	299.99	Classic Brown	33-1/4 x 8-3/4 x 4-1/8	1	1	N	Y	N	—	N	32
Over/Under with Extra Barrel	142850	299.99	Classic Brown	31 x 10-1/8 x 3-3/4	1	2	N	Y	N	—	N	30
Two Gun	142890	399.99	Classic Brown	36 x 8-1/4 x 5-3/8	2	2	N	Y	N	—	N	34
D Browning SA-22 Rifle	1428608090	289.99	Black/Tan	27-1/4 x 9 x 3-1/4	1	1	N	N	N	—	Y	—

LET'S SLIP THAT FINE BROWNING INTO SOME EXTRA PROTECTION.

Every valuable Browning firearm needs protection from moisture as well as the everyday bumps and scuffs that are part of moving guns into and out of a gun safe or gun rack. Browning VCI Gun Socks are designed to provide that extra layer of protection to keep your favorite Browning looking good for years to come.



VCI GUN SOCK

Vapor Corrosion Inhibitor (VCI) penetrates into the smallest crevices and drives out moisture where oils cannot reach • Provides full protection by forming a vapor enclosure around the firearm from muzzle to butt • Gives additional protection to all metal items in an enclosed area such as a gun safe or cabinet • One- or two-piece models to fit most firearms • Drawstring closure • Fits rifles and shotguns 48" to 56" • Firearms shown not included



	DESCRIPTION	CODE NUMBER	SUGGESTED RETAIL
A	One-Piece	149985	14.99
B	Two-Piece	149986	19.99



JOHN M. BROWNING BIOGRAPHY

The essential biography detailing the life and inventions of the greatest firearms inventor the world has ever known • Includes detailed original patent drawings and photographs • Hardcover • 390 pages

CODE NUMBER	SUGGESTED RETAIL
12980	29.99



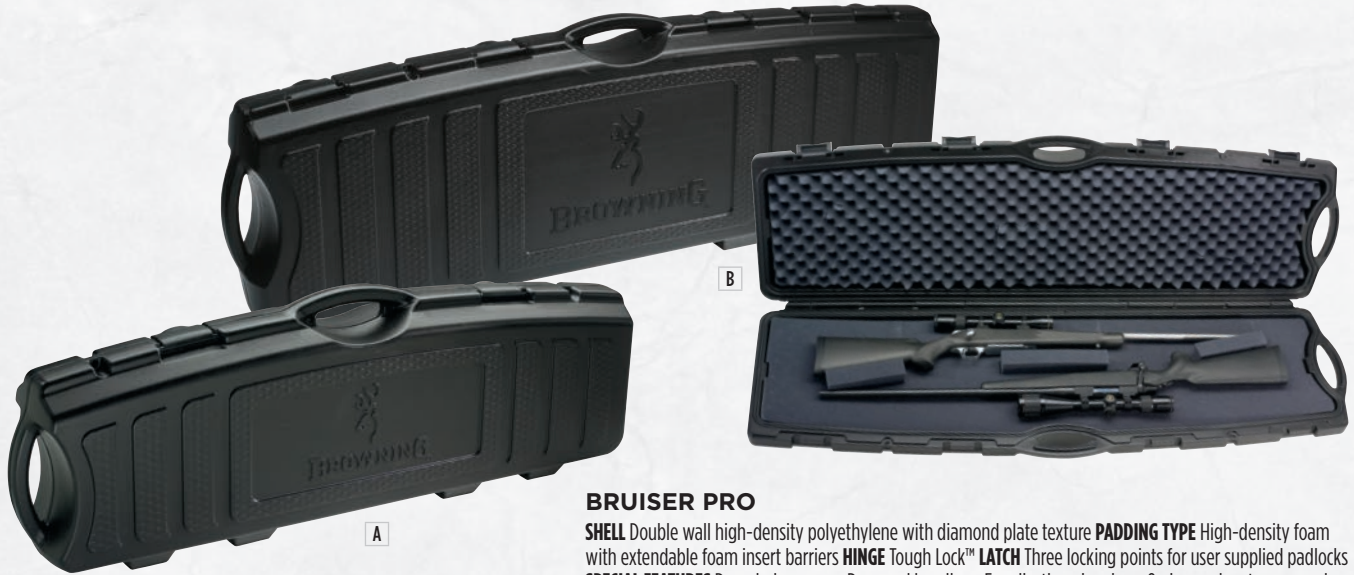

BRUISER PRO

SHELL Double wall high-density polyethylene with diamond plate texture **PADDING TYPE** High-density foam with extendable foam insert barriers **HINGE** Tough Lock™ **LATCH** Three locking points for user supplied padlocks **SPECIAL FEATURES** Rounded corners • Recessed handles • Equalization air valve • O-ring seal on tongue and groove lid for added protection • Recessed wheels • Zerust inserts • Airline approved • Firearms and accessories shown not included

	DESCRIPTION	DIMENSIONS W x D x H Inches	WEIGHT Lbs.	CODE NUMBER	SUGGESTED RETAIL
A	Take Down	38 x 14 x 5	14	1492001	209.99
B	Double Gun	54 x 15 x 5	19	1492002	259.99

Zerust®



MIRAGE

SHELL Copolymer **PADDING TYPE** Double convoluted foam **HINGE** Piano-style **LATCH** Four locking points **SPECIAL FEATURES** Single gun holds one scoped firearm • Oversize double case holds two scoped firearms • Airline approved • Corrosion-inhibiting Zerust® inserts

	DESCRIPTION	DIMENSIONS W x D x H Inches	WEIGHT Lbs.	CODE NUMBER	SUGGESTED RETAIL
A	Single Gun	53-5/8 x 12-1/8 x 3-3/4	5	1470022	59.99
B	Double Gun	53-3/8 x 16-1/2 x 4-1/2	12	1470021	89.99

Zerust®

SPORTER

SHELL Solid wood frame with PVC-coated exterior **PADDING TYPE** High-density convoluted foam **HINGE** Full-length leather **LATCH** Two combination locks **SPECIAL FEATURES** Interior tie-down straps • Firearms and accessories shown not included

DIMENSIONS W x D x H Inches	WEIGHT Lbs.	CODE NUMBER	SUGGESTED RETAIL
36-1/4 x 11 x 3-3/4	6	1422109408	239.99





SANTA FE

SHELL Waxed 10 oz. cotton canvas **LINING** Quilted flannel
PADDING TYPE Cotton batting **MUZZLE CAP** Leather
TRIM AND BINDING Crazy Horse tan leather or brown waxed cotton trim • Adjustable leather strap • Side pocket with choke tube loops on 52" model, cartridge loops on 48" model
 • Hook and loop pocket closure

	DESCRIPTION	COLOR/PATTERN	LENGTH Inches	CODE NUMBER	SUGGESTED RETAIL
A	Scoped	Tan	48	1419908248	209.99
B	Regular	Tan	52	1419908152	199.99



QUILTED CANVAS FLEX

SHELL Quilted waxed cotton canvas **LINING** Quilted interior **PADDING TYPE** Open- and closed-cell foam **MUZZLE CAP** Brown waxed cotton **TRIM AND BINDING** Brown waxed cotton
 • Bellows accessory pocket with hook and loop closure

	DESCRIPTION	COLOR/PATTERN	LENGTH Inches	CODE NUMBER	SUGGESTED RETAIL
A	Scoped	Brown/Dk. Brown	48	141995848	54.99
B	Regular	Brown/Dk. Brown	52	141995852	

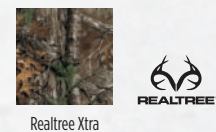

RUGGED FLEX

SHELL Heavy 1680 denier ballistic polyester in Realtree® Xtra camo **LINING** Quilted interior **PADDING TYPE** Open- and closed-cell foam **CLOSURE** Full-length, heavy-duty zipper with pull tab **TRIM AND BINDING** Heavy duty PVC tarpaulin spine and muzzle cap • Padded carry handle **SPECIAL FEATURES** Contoured zipper pocket • Gold Buckmark on black oval • 48" rifle model and 52" shotgun model

	DESCRIPTION	COLOR/PATTERN	LENGTH Inches	CODE NUMBER	SUGGESTED RETAIL
A	Scoped	RTX/Black	48	1419502448	54.99
B	Regular	RTX/Black	52	1419502452	



TALON

SHELL 600 denier poly canvas **LINING** Brushed tricot **PADDING TYPE** Open- and closed-cell foam
CLOSURE Zipper **TRIM AND BINDING** Polyester canvas **SPECIAL FEATURES** 3D Buckmark embroidery
 • Oversize design fits large optics and bipods • Two zipper closure pockets

COLOR/PATTERN	LENGTH Inches	CODE NUMBER	SUGGESTED RETAIL
Black	50	1410079250	59.99



HIDALGO

SHELL 600 and 1200 denier polyester canvas **LINING** Brushed tricot lining
PADDING TYPE Closed-cell foam **CLOSURE** Zipper **MUZZLE CAP** Simulated leather
TRIM AND BINDING Polyester **SPECIAL FEATURES** Embroidered Buckmark
 • Side pocket with choke tube loops on 52" model • Cartridge loops on 48" model • Hook and loop closure

	DESCRIPTION	COLOR/PATTERN	LENGTH Inches	CODE NUMBER	SUGGESTED RETAIL
A	Scoped	Brown/Clay	48	1410418248	44.99
B	Regular	Brown/Clay	52	1410418152	



PLAINSMAN

SHELL 600 denier polyester canvas **LINING** Brushed tricot
PADDING TYPE Open-cell foam **CLOSURE** Zipper
TRIM AND BINDING Polyester canvas

	DESCRIPTION	COLOR/PATTERN	LENGTH Inches	CODE NUMBER	SUGGESTED RETAIL
	Scoped	RTX	48	1410042448	39.99
	Regular	RTX	52	1410042452	
	Scoped	Black	40	1410049240	34.99
	Scoped	Black	44	1410049244	
	Scoped	Black	48	1410049248	
	Slip	Black	52	1410049052	
A	Slip	RTX	52	1410042152	39.99
	Slip	MOBUC	52	1410028052	
B	Regular	Black	52	1410049152	
	Regular	MOBUC	52	1410028152	39.99
C	Scoped	MOBUC	48	1410028248	

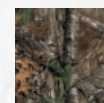

Realtree Xtra



Black

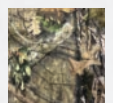

Mossy Oak
Break-Up Country



REALTREE



MOSSY OAK



CIMMARON II

SHELL 600 denier water-repellent PVC shell **LINING** Brushed tricot **PADDING TYPE** Open/closed-cell foam **CLOSURE** Zipper **TRIM AND BINDING** Polyester canvas • For Her models feature fuchsia trim and 3D embroidered Buckmark **SPECIAL FEATURES** Outside pocket on long gun models **MUZZLE CAP** Leather • Firearms and accessories shown not included

DESCRIPTION	COLOR/PATTERN	LENGTH Inches	CODE NUMBER	SUGGESTED RETAIL
A For Her, Scoped	Black/Tan/Fuchsia	48	1410409348	44.99
B For Her, Regular	Black/Tan/Fuchsia	52	1410409352	
C Scoped	Black/MOBUK	48	1410402448	54.99
D Regular	Black/MOBUK	52	1410402452	
Scoped	Black/Tan/Orange	40	1410409240	44.99
Scoped	Black/Tan/Orange	44	1410409244	
E Scoped	Black/Tan/Orange	48	1410409248	
F Regular	Black/Tan/Orange	52	1410409152	54.99
G BLR Takedown	Black/Tan/Orange	N/A	1410409090	





PURE BUCKMARK

SHELL Polyester canvas **LINING** Brushed tricot **PADDING TYPE** Open/closed-cell foam **CLOSURE** Zipper **TRIM AND BINDING** Contrasting polyester webbing
 • Screenprinted Buckmark

	DESCRIPTION	COLOR/PATTERN	LENGTH Inches	CODE NUMBER	SUGGESTED RETAIL
A	For Her, Scoped	Black/Fuchsia	48	1410029148	29.99
B	For Her, Regular	Black/Fuchsia	52	1410029252	
C	Slip, Scoped	Black/Gold	48	1410099048	
D	Slip, Regular	Black/Gold	52	1410019052	
E	Scoped	Black/Gold	40	1410019140	
F	Regular	Black/Gold	52	1410019148	



NEOPRENE GUN JACKET

Waterproof • Rugged stretchable neoprene material protects fine guns and optics from the elements and bumps during transportation
 • Designed to quickly insert and remove firearms • Folds for storage • Firearm and accessories shown not included

DESCRIPTION	COLOR/PATTERN	CODE NUMBER	SUGGESTED RETAIL
Shotgun	Black	12974299	59.99
Shotgun	RTM4	12974222	
Rifle	Black	12974199	
Rifle	RTX	12974124	



Black

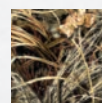

Realtree Max-4

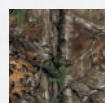

Realtree Xtra

WEATHERPROOF YOUR GUNS WITH BROWNING FLOATERS.

When it's great weather for ducks, it's lousy weather for the finish on your fine Browning guns. Give them some extra protection from the elements with Wicked Wing and Flyway Floater cases.



WICKED WING FLOATER

SHELL Polyester canvas **LINING** Nylon tricot **PADDING TYPE** High-density closed-cell foam
CLOSURE Zipper side closure allows easy drying • Hook and loop flap **TRIM AND BINDING** Tan webbing and accents with Wicked Wing embroidery **SPECIAL FEATURES** Side pocket • EVA foam muzzle cap with Buckmark • Hanging loop

	NEW 2016	DESCRIPTION	LENGTH Inches	CODE NUMBER	SUGGESTED RETAIL
A	•	MOBL	52	1410551952	49.99
B		MOSGB	52	1410552552	
C		RTM5	52	1410557652	



NEW 2016

FLYWAY FLOATER

SHELL 600 denier polyester with PVC clear coat **LINING** Polyurethane coated
PADDING TYPE High-density closed-cell foam **CLOSURE** Nylon zipper with TPU top coat **TRIM AND BINDING** Poly webbing and accents **SPECIAL FEATURES** Side pocket • Hanging loop • Hook and loop flap • Padded shoulder strap

	DESCRIPTION	LENGTH Inches	CODE NUMBER	SUGGESTED RETAIL
A	MOSGB	52	1410562552	69.99
B	RTM5	52	1410567652	





BLACK LABEL ALFA DOUBLE AR CASE

Heavy-duty padded ballistic polyester fabric shell with water-resistant urethane interior coating • Padded internal corner buffers help protect guns and optics • Internal hook and loop tie-down webbing holds two AR/modern sporting rifles • Fully-bound internal seams • Self-healing nylon coil zippers with corded pull tabs • Heavy web handles • Hidden pistol compartment • Padded shoulder straps in hidden zippered compartment • MOLLE compatible • Large exterior accessory pouch • Two removable zippered accessory pouches • External lashing straps • Embroidered Black Label logos • 37" W x 11" H x 3" D • Firearms and accessories shown not included

CODE NUMBER	SUGGESTED RETAIL
143501914	159.99



BLACK LABEL ALFA LONG GUN CASE

Heavy-duty ballistic polyester fabric shell • Large enough for a 40" scoped firearm • Exterior zippered accessory pocket • Full-length nylon main zipper allows open case to lay flat • D-rings and zipper eyelets accommodate locking device (lock not included) • Oxford polyester lining • Removable hook and loop tie-down straps help secure firearm • Heavy-duty closed-cell padding • Interior document security pocket • Embroidered Black Label logo

CODE NUMBER	SUGGESTED RETAIL
1415019240	44.99



AND DON'T FORGET A BLIND BAG FOR YOUR GEAR.

Now that you've protected your Browning guns, organize all your other gear in the blind, in the boat and on the road with a Flyway Blind Bag.



FLYWAY BLIND BAGS

SHELL 600 denier polyester with PVC clear coat **LINING** Polyurethane coated • Heat sealed main compartment **PADDING TYPE** High-density closed-cell foam **CLOSURE** Nylon zipper with TPU top coat **TRIM AND BINDING** Poly webbing and accents **SPECIAL FEATURES** Side pocket • Hanging loop

	DESCRIPTION	DIMENSIONS W x D x H Inches	CODE NUMBER	SUGGESTED RETAIL
A	MOSGB	19 x 9-1/2 x 15	121052591	129.99
B	RTM5	19 x 9-1/2 x 15	121057691	

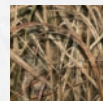

Mossy Oak Shadow Grass Blades

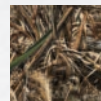

Realtree Max-5



BINO HARNESS

Keeps binoculars accessible and holds them securely on the chest to prevent bouncing • Elastic straps allow the binoculars to slide up and down the harness • Accommodates most binoculars • Binoculars shown are not included

CODE NUMBER	SUGGESTED RETAIL
12903	29.99

BINO HUB

Protective molded foam binocular compartment with comfortable harness system relieves strain on the neck • Unique binocular attachment allows for tension-free movement • Dual position range finder holder with high-power magnetic attachment • Range finder magnet wrap fits most popular range finders • Stretchable side pouch is ideal for keeping game calls, GPS units or other small accessories at the ready • Binoculars and range finder shown not included



Unique binocular attachment allows tension-free viewing.



Comfortable harness system eliminates strain on the neck.

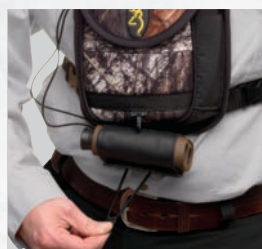

Backup lanyard and security bungee strap secures range finder.



CODE NUMBER	SUGGESTED RETAIL
12905	109.99



A

CATTELMEN RANGE BAG

Constructed with nylon canvas lining, brown suede body and Crazy Horse distressed leather trim • Foam padded sides maintain bag shape • Large compartmentalized interior holds 16 boxes of shells and allows separation of shell gauges • Sturdy zippers • Four exterior accessory pockets • Comfortable padded nylon web shoulder strap and sewn leather handles • Attractive antique brass hardware • 15" W x 10-1/2" H x 13" D

	CODE NUMBER	SUGGESTED RETAIL
A	121080081	299.99



B

CATTELMEN SHELL POUCH

Constructed with herringbone twill lining, brown suede body and Crazy Horse distressed leather trim • Adjustable nylon web belt with leather trim and heavy duty brass roller buckle • 9" W x 12-1/2" H x 3" D

	CODE NUMBER	SUGGESTED RETAIL
B	121080082	99.99



C

CATTELMEN SHELL CARRIER

Constructed with herringbone twill lining, brown suede body and Crazy Horse distressed leather trim • Leather covered metal clip attaches to belt • 5-1/4" W x 5-1/2" H x 3" D

	CODE NUMBER	SUGGESTED RETAIL
C	121080084	49.99



A

SANTA FE SHOOTING BAG

Constructed from 10 oz. waxed cotton canvas with Crazy Horse distressed leather trim • Foam padded sides maintain bag shape • Large compartmentalized interior holds 16 boxes of shells and allows separation of shell gauges • Sturdy zippers • Four exterior accessory pockets • Comfortable padded leather shoulder strap and handles • Attractive brass hardware • 12" W x 10" H x 9" D

	CODE NUMBER	SUGGESTED RETAIL
A	121040081	219.99



B

SANTA FE SHELL POUCH

Constructed from 10 oz. waxed cotton canvas with Crazy Horse distressed leather trim • Large empty hull pouch • Shell box holder with three choke tubes/shell loops • Adjustable belt with quick release buckle • 9" W x 15" H x 5" D • Ammunition shown not included

	CODE NUMBER	SUGGESTED RETAIL
B	121040082	89.99



C

SANTA FE SHELL CARRIER

Constructed from 10 oz. waxed cotton canvas with Crazy Horse distressed leather trim • Metal clip attaches to belt • 5-1/4" W x 5-1/2" H x 3" D • Ammunition shown not included

	CODE NUMBER	SUGGESTED RETAIL
C	121040084	29.99



PURE BUCKMARK SHOOTING BAG

600 denier polyester shell • Padded interior for rigid shape • Five exterior accessory pockets • Comfortable contrasting padded handles and shoulder strap • Interior divider • For Her model has pink trim and Buckmark • 11" W x 9" H x 8" D • Accessories shown not included

	DESCRIPTION	CODE NUMBER	SUGGESTED RETAIL
A	Shooting Bag	121021991	64.99
B	Shooting Bag For Her	121002991	



PURE BUCKMARK SHELL POUCHES

600 denier polyester shell • Large double compartment design • Shell box holder with four choke tube/shell loops • Contrasting webbing • Adjustable belt with quick release buckle • For Her model has pink trim and Buckmark • Short is 9" W x 12" H x 4-1/2" D • Long is 9" W x 15" H x 4-1/2" D • Ammunition shown not included

	DESCRIPTION	CODE NUMBER	SUGGESTED RETAIL
A	Short	121021992	24.99
B	Short For Her	121002992	
C	Long	121021993	



PURE BUCKMARK SHELL BOX CARRIER

Metal clip attaches to belt • Contrasting webbing • Buckmark imprint • 5-1/4" W x 5-1/2" H x 3" D • Ammunition shown not included

CODE NUMBER	SUGGESTED RETAIL
121021994	14.99

PURE BUCKMARK EMPTY SHELL CARRIER

Attaches to belt • Mesh pouch • Contrasting webbing • Buckmark imprint • 10" W x 20" H x 4" D

CODE NUMBER	SUGGESTED RETAIL
121021995	17.99





CROSSFIRE MODULAR RANGE BAGS

600 denier polyester shell • Full-length semi-rigid interior divider • Padded interior with hook and loop panels allow user to configure interior to specific storage needs • Internal mesh document pocket • Two large exterior accessory pockets on sides • Fold-out removable plush surfaced gun cleaning mat • End pocket is sized for holding hearing protection • Two end pockets are sized for ammo boxes • Comfortable padded carry handles • Rubber-clad double pull strap • Large model (shown) is 23" W x 10" H x 14" D and includes two modular internal pistol holders, one magazine holder, one mesh bag for brass, one ammo pocket and one eyewear/accessory pouch • Small model is 19" W x 13" H x 9" D and includes one modular internal pistol holder, one magazine holder, one mesh brass bag and one eyewear/accessory pouch • Firearms, ammunition and accessories shown not included

DESCRIPTION	CODE NUMBER	SUGGESTED RETAIL
(SHOWN IN LARGE)		
Small	121070018	99.99
Large	121070024	114.99

HIDALGO RANGE BAG

600 and 1200 denier polyester canvas • Large oversized main body holds 10 shell boxes plus gear • Three large double-zip accessory pockets • Two large single zip accessory pockets • Gate mouth keeps bag open for easy access • Comfortable padded handles and shoulder strap • Lockable zipper closures on main compartment • 18" W x 12-1/2" H x 11" D

CODE NUMBER	SUGGESTED RETAIL
121041891	69.99



HIDALGO SHELL CARRIERS

ONE BOX Holds one box of shotgun shells for instant access • Metal clip attaches to belt • 5-1/4" W x 5-1/2" H x 3" D **SIX BOX** Accessory pockets • Sturdy web handles • 7" W x 9" H x 5" D (excluding exterior pockets) • Ammunition and accessories shown not included

	DESCRIPTION	CODE NUMBER	SUGGESTED RETAIL
A	One Box	121041894	9.99
B	Six Box	121041895	17.99

HIDALGO SHELL POUCH

600 and 1200 denier polyester canvas • Large double compartment • Adjustable belt with quick release buckle • 9" W x 11" H x 4-3/4" D

CODE NUMBER	SUGGESTED RETAIL
121041893	19.99





NEW 2016

CIMMARON II SHOOTING BAGS

600 denier water-repellent PVC shell • Padded interior for rigid shape • Four exterior accessory pockets • Comfortable padded handles and shoulder strap • Interior divider • For Her model has fuchsia trim and Buckmark • 11-1/2" W x 10" H x 9" D

	DESCRIPTION	CODE NUMBER	SUGGESTED RETAIL
A	Shooting Bag	121040091	69.99
B	Shooting Bag For Her	121040391	

NEW 2016

CIMMARON II RANGE BAGS

600 denier water-repellent PVC shell • Two padded pistol pockets with lockable zip closure • Main compartment has double zip opening for easy access • Adjustable padded shoulder strap • 12 elasticized interior magazine loops • For Her model has fuchsia trim and Buckmark • 13" W x 8" H x 8-1/2" D

	DESCRIPTION	CODE NUMBER	SUGGESTED RETAIL
A	Two Pistol Range Bag	121040093	49.99
B	Two Pistol Range Bag For Her	121040393	



NEW 2016

CIMMARON II SHELL POUCHES

600 denier PVC mesh pouch • Large empty hull pouch • Shell box holder with choke tube/shell loops • Adjustable belt with quick-release buckle • For Her model has fuchsia trim and Buckmark • Large is 9" W x 15" H x 4-1/4" D • For Her is 9" W x 11-1/4" H x 4" D

	DESCRIPTION	CODE NUMBER	SUGGESTED RETAIL
A	Large Shell Pouch	121040092	29.99
B	Shell Pouch For Her	121040392	

NEW 2016

CIMMARON II SHELL CARRIERS

ONE BOX Metal clip attaches to belt • 5-1/4" W x 5-1/2" H x 3" D
FOUR BOX Accessory pockets • Sturdy web handles • 10" W x 4-1/2" H x 5-1/4" D excluding exterior pocket

	DESCRIPTION	CODE NUMBER	SUGGESTED RETAIL
A	One Box	121040094	14.99
B	Four Box	121040095	



A

B



BLACK LABEL®
TACTICAL GEAR

BLACK LABEL ALFA RANGE BAG

Heavy-duty padded ballistic polyester fabric shell with water-resistant urethane interior coating • Polymer bottom scuff pads • Self-healing nylon coil zippers with paracord pull tabs • Heavy web handles • Two zippered end compartments • Roomy main compartment with four organizer pockets • Two zippered side compartments with six elastic magazine retainers and internal organizer pockets • Removable ammo/accessory bag with zippered top and hook and loop side pockets • Embroidered Black Label logo • 15" W x 9" H x 11" D • Firearm and accessories shown not included

CODE NUMBER	SUGGESTED RETAIL
121501991	89.99



BLACK LABEL ALFA SHOULDER BAG

Heavy-duty ballistic polyester fabric shell • Heavy-duty self-healing nylon coil zippers with paracord pull tabs • Lay-flat design allows full access to main compartment contents • Fully-bound internal seam edging • Top grab loop and padded shoulder strap • MOLLE compatible nylon webbing on sides and rear • Three zippered compartments with multiple internal zippered organizer pockets • Hidden rapid-access sidearm pocket with hook and loop lining and closure • Removable accessory pouch • Embroidered Black Label logo • Black • 10" W x 13" H x 8" D • Firearm and accessories shown not included

CODE NUMBER	SUGGESTED RETAIL
121501995	89.99

BLACK LABEL ALFA TACTICAL GEAR BAG

The ultimate mid-size tactical gear and range bag • Use as a backpack or as a duffel • Heavy-duty ballistic polyester fabric shell with water-resistant urethane interior coating • Self-healing nylon coil zippers with paracord pull tabs • Multiple heavy web handles and haul loops • Large zippered top load compartment • Hidden full-length hydration bladder compartment • Mesh document organizer pockets • Top end headphone/microphone port with hook and loop closure • Hidden pistol compartment • Two elastic mesh side pockets • Bottom zippered compartment with three metal drain grommets for wet gear • Padded shoulder straps and back panel • Adjustable web waist belt with QD buckle • MOLLE compatible • Embroidered Black Label logos • 15" W x 24" H x 9" D • Internal volume approximately 2135 cubic inches • Firearm and accessories shown not included

CODE NUMBER	SUGGESTED RETAIL
121501996	129.99



The Alfa Tactical Gear Bag instantly converts from a well-balanced hand duffel to a rugged double strap backpack for longer treks across the range with heavier loads.

The Alfa Tactical Gear Bag provides loads of room for guns, ammo and accessories. The wide opening offers quick and easy access to everything inside.

The Alfa Tactical Gear Bag's hidden pistol pocket allows discrete transportation and storage (plus instant access) to a lawfully-carried concealed handgun.



SANTA FE

SHELL Cotton canvas **LINING** Nylon tricot **PADDING TYPE** Cotton batting **CLOSURE** Zipper **TRIM AND BINDING** Polyester nylon **SPECIAL FEATURES** D-ring so case can be locked (lock not included)

DESCRIPTION	LENGTH Inches	CODE NUMBER	SUGGESTED RETAIL
Tan	11	143990811	49.99



CIMMARON II

SHELL Polyester canvas **LINING** Brushed tricot **PADDING TYPE** Open/closed-cell foam **CLOSURE** Zipper **TRIM AND BINDING** Polyester nylon **SPECIAL FEATURES** D-ring so case can be locked (lock not included)

	DESCRIPTION	LENGTH Inches	CODE NUMBER	SUGGESTED RETAIL
A	Black/Orange	13	143040913	19.99
	Black/Orange	11	143040911	17.99
B	For Her, Black/Fuchsia	11	1430409311	



PLAINSMAN

SHELL Polyester canvas **LINING** Nylon tricot **PADDING TYPE** Open-cell foam **CLOSURE** Zipper **TRIM AND BINDING** Polyester nylon **SPECIAL FEATURES** D-ring so case can be locked (lock not included)

	DESCRIPTION	LENGTH Inches	CODE NUMBER	SUGGESTED RETAIL
A	Black	13	1430049813	17.99
	Black	11	1430049811	14.99
B	RTX	13	1430042413	19.99
	MOBUC	13	1410028813	



HIDALGO

SHELL Polyester canvas **LINING** Nylon tricot **PADDING TYPE** Closed-cell foam **CLOSURE** Zipper **TRIM AND BINDING** Polyester nylon **SPECIAL FEATURES** D-ring so case can be locked (lock not included)

DESCRIPTION	LENGTH Inches	CODE NUMBER	SUGGESTED RETAIL
Black/Clay	13	1430418813	19.99
Black/Clay	11	1430418811	17.99



PURE BUCKMARK

SHELL Polyester canvas **LINING** Brushed tricot **PADDING TYPE** Open/closed-cell foam **CLOSURE** Zipper **TRIM AND BINDING** Contrasting polyester webbing **SPECIAL FEATURES** D-ring so case can be locked (lock not included)

	DESCRIPTION	LENGTH Inches	CODE NUMBER	SUGGESTED RETAIL
A	Black/Yellow	13	143003913	17.99
	Black/Yellow	11	143003911	
B	For Her, Black/Fuchsia	9	143002909	



CROSSFIRE DOUBLE PISTOL CASE

SHELL Heavy 600 denier polyester **LINING** Nylon fabric with two offset padded pockets to protect standard size pistols **PADDING TYPE** Closed-cell foam **CLOSURE** Double pull zippers with nylon pull tabs **TRIM AND BINDING** Polyester and nylon • Fully-bound sewn edges **SPECIAL FEATURES** Two large zippered side pockets, one with five magazine storage slots, the other with three ammo box and accessory slots • Two mesh exterior pockets with hook and loop closures for documents and smaller flat items • Nylon web carry handles • Firearms shown not included

DESCRIPTION	LENGTH Inches	CODE NUMBER	SUGGESTED RETAIL
Black/Gray	13	12902099	44.99



FLEX FOAM CASE

SHELL 600 denier polyester **LINING** Soft laminated nylon tricot **PADDING TYPE** Form-fitting EVA foam **CLOSURE** Zipper **TRIM AND BINDING** Polyester and nylon • D-rings for attaching shoulder strap (not included) **SPECIAL FEATURES** Magazine storage • Nylon carry straps • Firearms and accessories shown not included

DESCRIPTION	LENGTH Inches	CODE NUMBER	SUGGESTED RETAIL
Black	15	1419001	54.99



BLACK LABEL ALFA PISTOL CASE

Heavy-duty ballistic polyester fabric shell • Military-grade closed-cell foam padding • Self-healing nylon coil main zipper with paracord pull tabs and lockable eyelets • Heavy sewn web handles • Six elastic magazine retainers and an internal zippered pocket for sidearms with up to 7" barrel • Embroidered Black Label logo • 11" W x 9" H x 2-1/2" D • Firearm and accessories shown not included

CODE NUMBER	SUGGESTED RETAIL
143501911	29.99



BLACK LABEL ALFA DOUBLE PISTOL CASE

Heavy-duty padded ballistic polyester fabric shell with water-resistant urethane interior coating • Two form-fitted internal zippered pistol pockets • Six elastic magazine slots • Fully-bound internal seams • Self-healing nylon coil zippers with corded pull tabs • Heavy web handles • MOLLE compatible • Accessory pouch • Embroidered Black Label logos • 12" W x 10" H x 2-1/2" D • Firearms and accessories shown not included

CODE NUMBER	SUGGESTED RETAIL
143501912	44.99



NEW CAMOS



X-CELLERATOR PLUS

Padded neoprene shoulder strap prevents the firearm from slipping off the shoulder
 • Patented slip-lock buckle is easy to adjust, even with winter gloves
 • Metal sling swivels are included
 • Ammunition shown not included

NEW 2016	DESCRIPTION	FITS	LENGTH	CODE NUMBER	SUGGESTED RETAIL	
A	Realtree Xtra	Rifles	25-1/2 to 28	122324025	54.99	
	Black	Rifles	25-1/2 to 28	122312025		
	Mossy Oak Break-Up Country	Rifles	25-1/2 to 28	122312825		
	Digital Camo	Rifles	25-1/2 to 28	122313425		
B	Black	Shotguns	38 to 48	122312035	59.99	
	Mossy Oak Shadow Grass Blades	Shotguns	38 to 48	122312525		
	Mossy Oak Break-Up Country w/ Loops	Rifles	25-1/2 to 28	122302525		64.99
	Black w/ Loops	Rifles	25-1/2 to 28	122302325		

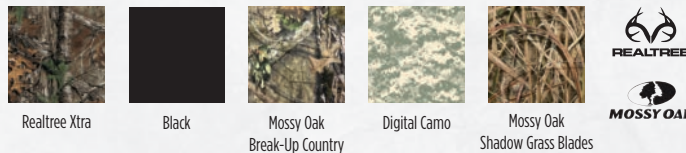

NEW CAMOS

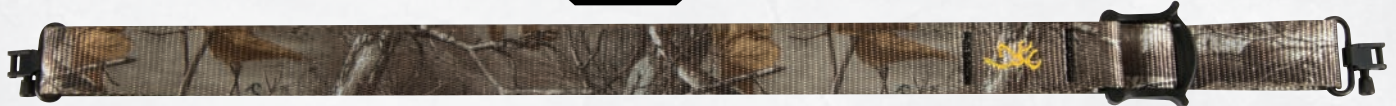

X-CELLERATOR

Patented slip-lock buckle is easy to adjust, even when wearing winter gloves
 • Innovative design can be positioned as either a shoulder-style or a backpack sling
 • Provides a wide range of adjustment plus a generous 1-1/4" width
 • Metal sling swivels are included

NEW 2016	DESCRIPTION	FITS	LENGTH	CODE NUMBER	SUGGESTED RETAIL
(SHOWN IN REALTREE XTRA)					
	Realtree Xtra	Rifles	25-1/2 to 28	122324125	44.99
	Black	Rifles	25-1/2 to 28	122302025	
	Tan	Rifles	25-1/2 to 28	122301425	
	Digital Camo	Rifles	25-1/2 to 28	122303425	
	Mossy Oak Break-Up Country	Rifles	25-1/2 to 28	122302825	49.99
	Black	Shotguns	29-3/4 to 48-1/4	122302029	
	Mossy Oak Shadow Grass Blades	Shotguns	29-3/4 to 48-1/4	122302529	

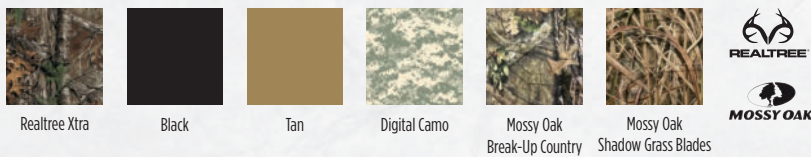

NEW CAMO



ECLIPSE

Patented slip-lock buckle is easy to adjust, even when wearing winter gloves
 • Innovative design can be positioned as either a shoulder-style or a backpack sling
 • Provides a wide range of adjustment plus a generous 1-1/4" width
 • Metal sling swivels are included

NEW 2016	DESCRIPTION	FITS	LENGTH	CODE NUMBER	SUGGESTED RETAIL
(SHOWN IN MOSSY OAK BREAK-UP COUNTRY)					
	Black	Rifles	25-1/2 to 28	122320025	54.99
	Mossy Oak Break-Up Country	Rifles	25-1/2 to 28	122320225	

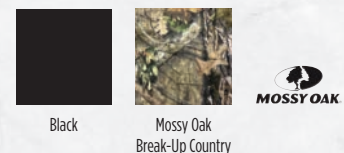

NEW CAMO



NEOPRENE

Shock-absorbing neoprene pad offers superior comfort, even with heavy firearms • Thumb loop lets the supporting hand share part of the firearm's weight for easier carrying and less shoulder fatigue • Rubberized pad backing is textured for a positive, non-slip grip • Polymer ladder buckle offers easy one-hand adjustment • Metal sling swivels are included

NEW 2016	DESCRIPTION	FITS	LENGTH	CODE NUMBER	SUGGESTED RETAIL
(SHOWN IN MOSSY OAK BOTTOMLAND)					
•	Waterfowl, Mossy Oak Bottomland	Shotguns	25-1/2 to 50	12201419	39.99
	Big Game, Black	Rifles	25-1/2 to 50	12201399	
	Big Game, Realtree Xtra	Rifles	25-1/2 to 50	12201324	
	Waterfowl, Mossy Oak Shadow Grass Blades	Shotguns	25-1/2 to 50	12201425	
	Waterfowl, Realtree Max-5	Shotguns	25-1/2 to 50	12201376	

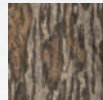

Mossy Oak Bottomland



Black

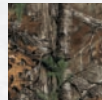

Realtree Xtra

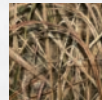

Mossy Oak Shadow Grass Blades

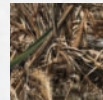

Realtree Max-5



FLEX GRIP

Comfortable molded rubberized pad allows for stretch when walking • Back of pad is textured for a positive, non-slip grip • Adjustable length • Rifle cartridge loops • Metal sling swivels are included

DESCRIPTION	FITS	LENGTH	CODE NUMBER	SUGGESTED RETAIL
Black	Most Rifles	25-1/2 to 41	1226799	49.99



FLEX FOAM SPORTER

Waterproof, extra-thick molded foam pad has hourglass shape to provide the ultimate in comfort, even with heavy firearms • Back of pad is textured for a positive, non-slip grip • Adjustable length • Metal sling swivels are included

DESCRIPTION	FITS	LENGTH	CODE NUMBER	SUGGESTED RETAIL
(SHOWN IN MOSSY OAK NEW BREAK-UP)				
Black	Most Rifles	25-1/2 to 39	12230	24.99
Mossy Oak New Break-Up	Most Rifles	25-1/2 to 39	12231	29.99



Black

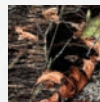

Mossy Oak New Break-Up



CONTOUR CLINCHER

Quiet Dura-Touch Armor Coating helps improve grip in adverse weather conditions • Comfortable contour fit pad profile won't slide or roll off the shoulder • Adjustable length • Colorfast materials resist cracking and fading • Metal sling swivels are included

DESCRIPTION	FITS	LENGTH	CODE NUMBER	SUGGESTED RETAIL
(SHOWN IN GREEN CAMO)				
Black	Rifles and Shotguns	30 to 41-1/2	122920	49.99
Green Camo	Rifles and Shotguns	30 to 41-1/2	12294009	



Black

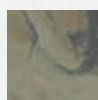

Green Camo





AMERICANA

High quality top grain bison leather • Suede backing • Edge stitching • Red and blue leather insert • Buckmark patch • Sterling silver plated medallions of eagle and American flag
 • Made in the USA • Swivels are not included • Fits most rifles and shotguns

SWIVEL STUD DISTANCE Inches	CODE NUMBER	SUGGESTED RETAIL
25-1/2 to 28	122615	109.99



FREEDOM

Multi-grain high quality leather • Suede backing • Edge stitching • Antiqued American flag appliqué • Buckmark patch • Made in the USA • Swivels are not included • Fits most rifles and shotguns

SWIVEL STUD DISTANCE Inches	CODE NUMBER	SUGGESTED RETAIL
25-1/2 to 28	122616	109.99



HERITAGE

Hand-stained latigo leather • Suede backing • Contrasting figure-eight stitching • Buckmark patch
 • Made in the USA • Swivels are not included • Fits most rifles and shotguns

SWIVEL STUD DISTANCE Inches	CODE NUMBER	SUGGESTED RETAIL
25-1/2 to 28	122617	99.99



RANCH

Aged bark-oiled Nubuck leather • Suede backing • X-welting with contrasting stitching
 • Buckmark patch • Made in the USA • Swivels are not included • Fits most rifles and shotguns

SWIVEL STUD DISTANCE Inches	CODE NUMBER	SUGGESTED RETAIL
25-1/2 to 28	122618	99.99



HORSEHAIR

Attractive muted colors and braided horsehair patterns create a stylish and comfortable sling with a rustic Old West flair • Features all-leather reinforcement and a thumb loop for all-day comfort in the field • Adjustable length • Swivels are not included • Fits most rifles and shotguns

DESCRIPTION	SWIVEL STUD DISTANCE Inches	CODE NUMBER	SUGGESTED RETAIL
A Timber	25 to 36-1/2	122294	89.99
B Black	25 to 36-1/2	122299	
C Driftwood	25 to 36-1/2	122298	



BUFFALO NICKEL

Full-grain leather construction with classic basketweave design and comfortable suede backing • Tapered shape provides added width at shoulder • Unique buffalo nickel overlays • Braided horsehair inlay panel • Adjustable length • Swivels are not included • Fits most rifles

SWIVEL STUD DISTANCE Inches	CODE NUMBER	SUGGESTED RETAIL
25-1/2 to 28	122602	84.99



BARBED WIRE

Full-grain leather construction with comfortable suede backing • Twisted leather cord provides a rustic barbed wire look that's perfect for both modern and historic rifles • Tapered shape provides added width at shoulder • Adjustable length • Swivels are not included • Fits most rifles

SWIVEL STUD DISTANCE Inches	CODE NUMBER	SUGGESTED RETAIL
25-1/2 to 28	122604	84.99



JMB SIGNATURE SERIES

Top grain high quality leather • Suede backing • Edge stitching • Embossed with John M. Browning's signature • Quality brass hardware • Available in black, dark brown and walnut brown • Metal sling swivels are included • Fits most rifles and shotguns

DESCRIPTION	SWIVEL STUD DISTANCE Inches	CODE NUMBER	SUGGESTED RETAIL
A Black	25-1/2 to 35-1/2	122399	79.99
B Dark Brown	25-1/2 to 35-1/2	122398	
C Walnut Brown	25-1/2 to 35-1/2	122388	



RIO LOBO

Classic Western spiral stitch design in contrasting thread • Sliding shoulder adjustment with embossed logo • Adjustable length • Swivels are not included • Fits most rifles • Cartridges shown not included

SWIVEL STUD DISTANCE Inches	CODE NUMBER	SUGGESTED RETAIL
25-1/2 to 35-1/2	12260	64.99



LATIGO MILITARY

Traditional 1907-pattern US military-style sling adjusts to give support in the prone, sitting and kneeling positions • Metal sling swivels are included • Fits most rifles and shotguns

SWIVEL STUD DISTANCE Inches	CODE NUMBER	SUGGESTED RETAIL
25-1/2 to 50	12244	64.99



SANTA FE

Wide upper portion is padded for added comfort • Brass hardware • Crazy Horse distressed leather model has full-length contrasting side stitching and an oval Buckmark patch • Brown model offers top-grain, silicone-treated leather with leather ties • Embossed Buckmark logo • Adjustable length • Metal sling swivels are included on Crazy Horse model • Fits most rifles

	DESCRIPTION	SWIVEL STUD DISTANCE Inches	CODE NUMBER	SUGGESTED RETAIL
A	Crazy Horse	25-1/2 to 35-1/2	122503	54.99
B	Brown	25-1/2 to 35-1/2	12249	59.99



WESTERN STITCH

Traditional Western stitch design is sewn freehand with contrasting thread • Adjustable length • Swivels are not included • Fits most rifles

SWIVEL STUD DISTANCE Inches	CODE NUMBER	SUGGESTED RETAIL
25-1/2 to 35-1/2	1225012	54.99



ANTIQUE BASKETWEAVE

Classic embossed basketweave design with full-length contrasting side stitching • Adjustable length • Swivels are not included • Fits most rifles

SWIVEL STUD DISTANCE Inches	CODE NUMBER	SUGGESTED RETAIL
25-1/2 to 35-1/2	1225098	54.99



SIX MILE II

Top grain leather construction • Classic Western stitch design in contrasting thread • Sliding shoulder adjustment with embossed logo • Adjustable length • Metal sling swivels are included • Fits most rifles and shotguns

SWIVEL STUD DISTANCE Inches	CODE NUMBER	SUGGESTED RETAIL
21-1/2 to 36	122431	49.99



BIG BUCKMARK SERIES

Top grain vegetable tanned leather • Large Buckmark embossing • Quality brass hardware • Swivels are not included • Fits most rifles and shotguns



	DESCRIPTION	SWIVEL STUD DISTANCE Inches	CODE NUMBER	SUGGESTED RETAIL
A	Black	25-1/2 to 35-1/2	122499	39.99
B	Distressed Brown	25-1/2 to 35-1/2	122488	
C	Brown	25-1/2 to 35-1/2	122498	



1911-22/1911-380 LOCK-PRO HOLSTER

Molded polymer holster for secure, positive carry • Friction lock design with fully-enclosed trigger guard for added safety • Tek-Lok™ belt clip • Fits all 1911-22 and 1911-380 pistols including rail models • Pistols shown not included

	DESCRIPTION	CODE NUMBER	SUGGESTED RETAIL
A	Black	12903011	44.99
B	Desert Tan	12903013	

1911  22 1911  380



1911-22/1911-380 LEATHER HOLSTERS

SLIDE HOLSTER Leather belt slide design is ideal for licensed concealed carry • Belt loops on both sides • Can be used for right-side or left-side carry either on the belt or inside the waistband **FLAP HOLSTER** Leather flap model is styled like the original U.S. Military holster • Leather ties • Embossed U.S. oval • Pistols shown not included

	DESCRIPTION	CODE NUMBER	SUGGESTED RETAIL
A	Slide Holster	12903022	19.99
B	Flap Holster	1296522	59.99



1911  22 1911  380



1911-22/1911-380 NYLON HOLSTER

Tough ballistic nylon construction with molded polymer frame and heavy duty sewn edging • Magazine pouch • Belt loop • Web strap for added safety and security • Pistol and magazine shown not included

CODE NUMBER	SUGGESTED RETAIL
12903012	29.99

1911  22 1911  380

BUCK MARK PISTOL HOLSTERS

Tough ballistic nylon construction with molded polymer frame and heavy duty sewn edging • Fits most Buck Mark pistols • Oversized model will accommodate the Buck Mark pistol fitted with a small scope or reflex sight • Magazine Pouch model keeps a spare magazine handy • Belt loop • Web strap for added safety and security • Pistols and magazines shown not included

	DESCRIPTION	CODE NUMBER	SUGGESTED RETAIL
A	Buck Mark Pistol Holster	12902010	29.99
B	Buck Mark Pistol Holster with Magazine Pouch	12902012	
C	Oversized Buck Mark Holster (Fits Small Optics)	12902011	





MOA MODULAR SHOOTING REST SET

Ballistic nylon construction • Four modular components allow the shooter to quickly configure the rest for ideal height • Polymer pellet fill in top and bottom modules allow for easy repositioning and provide a solid rest • Foam filled height adjustment modules absorb recoil and vibration • Hook and loop panels quickly lock modules together • Long V-shaped trough in top module holds rifle or shotgun forearm securely • Will not mar delicate surfaces • Web carry strap

CODE NUMBER	SUGGESTED RETAIL
129104	84.99



MOA UTILITY SHOOTING REST

Ballistic nylon construction • Rubberized top and bottom to hold both gun and bag in place while shooting • Polymer pellet fill allows for easy repositioning and provides a solid rest • Perfect for sighting-in rifles or handguns or when patterning shotguns

CODE NUMBER	SUGGESTED RETAIL
129101	44.99



MOA TWO-PIECE SHOOTING REST

Ballistic nylon construction • Rubberized top and bottom to hold both gun and bag in place while shooting • Polymer pellet fill allows for easy repositioning and provides a solid rest • D-ring and snap hook keep bags together while storing • Heel/toe design provides stable shooting platform

CODE NUMBER	SUGGESTED RETAIL
129100	54.99



MOA WINDOW MOUNT

Ballistic nylon construction • Rubberized top and bottom to hold both gun and bag in place while shooting • Polymer pellet fill allows for easy repositioning and provides a solid rest • Polymer filled wings provide a stable position in a shooting house window or over treestand frames • V-frame rest provides a solid platform to support firearm without lateral movement

CODE NUMBER	SUGGESTED RETAIL
129103	44.99





FLEX FOAM CARTRIDGE CASES

Molded Flex Foam is lightweight and durable • Holds eight or 10 centerfire rifle cartridges ready for easy access • Secure elastic cord or hook and loop closure
 • Triple stitched nylon webbed belt loop for easy carry on belt or pack strap
 • Cartridges are not included

	DESCRIPTION	CODE NUMBER	SUGGESTED RETAIL
A	8 Cartridge Case	12180	34.99
B	10 Cartridge Carrier	12191	

LEATHER CARTRIDGE CASES

CRAZY HORSE CARTRIDGE CASE Distressed Crazy Horse leather construction with full edge stitching
LEATHER CARTRIDGE CASE Top-grain leather construction with full edge stitching • Both are folding designs holding 10 centerfire rifle cartridges for easy, quick access • Brass snaps • Belt loops
 • Cartridges are not included

	DESCRIPTION	CODE NUMBER	SUGGESTED RETAIL
A	Crazy Horse Leather	12198	49.99
	Crazy Horse Magnum	12199	
B	Leather	12195	44.99



FLEX FOAM CHOKE TUBE CASE

Molded foam with rugged nylon cover and full-length zipper • Holds five extended choke tubes in individual elastic bands • Improved design accommodates both flush mount and extended Invector-DS tubes • Accessory pocket holds small items • Choke tubes are not included

CODE NUMBER	SUGGESTED RETAIL
1211130	39.99

STOCK OPTION

Rugged ballistic nylon construction • Neoprene comb pad • Zipper pocket for spare ammo or cleaning gear • Attaches securely with hook and loop tabs • Accommodates sling swivels • Rifle and cartridges are not included

CODE NUMBER	SUGGESTED RETAIL
12906	44.99



AB3 RIFLE

Detachable staggered box magazine has a formed steel body with integrated feed lips for durability

- Tough polymer baseplate and shoulder prevents recoil-induced bullet tip deformation and bullet setback
- Magazine capacity is three rounds in magnum calibers and four rounds in standard calibers

CALIBER	CODE NUMBER	SUGGESTED RETAIL
Short Action Standard: 243 Win., 7mm-08 Rem., 308 Win.	112024045	59.99
Short Action Magnum: 270 WSM, 300 WSM	112024044	
270 Win.	112024038	
30-06 Sprg.	112024039	
7mm Rem. Mag.	112024042	
300 Win. Mag.	112024043	

**A-BOLT RIFLE**

Hinged floorplate with detachable box magazine makes it simple and fast to load a spare magazine

- Magnum caliber holds three cartridges
- Standard caliber holds four cartridges **FITS ALL A-BOLT RIFLE MODELS EXCEPT MICRO HUNTER. NOTE: A-BOLT MAGAZINES THAT ARE NOT LISTED HERE MAY BE AVAILABLE ONLY THROUGH THE BROWNING PARTS DEPARTMENT AT (800) 322-4626.**

CALIBER	CODE NUMBER	SUGGESTED RETAIL
243 Win.	112022011	99.99
270 WSM	112022035	
7mm-08 Rem.	112022016	
308 Win.	112022018	
A 300 WSM	112022034	
270 Win.	112022024	
30-06 Sprg.	112022026	
7mm Rem. Mag.	112022027	
300 Win. Mag.	112022029	

A-BOLT SHOTGUN MAGAZINE

Flush-mounted detachable box magazine • Capacity of two 12 gauge shells

GAUGE	CODE NUMBER	SUGGESTED RETAIL
B 12	112022001	99.99

X-BOLT RIFLE

Detachable rotary magazine constructed from a durable lightweight polymer • Feeds cartridges directly in line with the bolt, instead of offset as with traditional leaf-spring magazines for a straight path right into the chamber • Ergonomic magazine-mounted release • Magnum caliber holds three cartridges • Standard caliber holds four cartridges • Unique design holds U.S. patent numbers: 8,156,675; 8,484,875 and 8,745,912

CALIBER	CODE NUMBER	SUGGESTED RETAIL
Long Action Magnum: 338 Win. Mag., 300 Win. Mag., 7mm Rem. Mag.	112044601	59.99
Long Action Magnum: 26 Nosler	112044605	
Long Action Standard: 30-06 Sprg., 280 Rem., 270 Win., 25-06 Rem.	112044602	
Short Action Magnum: 325 WSM, 300 WSM, 7mm WSM, 270 WSM	112044603	
Short Action Standard: 308 Win., 7mm-08 Rem., 243 Win.	112044604	
Short Action Standard: 6.5 Creedmoor	112044607	
Super Short Action Standard: 223 Rem.	112044008	
Super Short Action Standard: 22-250 Rem.	112044009	
Super Short Action Standard: 204 Ruger	112044007	
Large Magnum: 375 H&H Magnum	112044606	

**T-BOLT RIFLE**

10-round capacity • Metal and polymer body • The patented Double Helix rotary box magazine uses torsion spring-driven interlocking gears for added reliability

- Easy loading and unloading
- Cartridges shown not included

CALIBER	CODE NUMBER	SUGGESTED RETAIL
22 LR	112055290	64.99
17 HMR/22 WMR	112055291	





BAR

Detachable box magazines for the BAR • Unique hinged floorplate design • Allows you to lower the floorplate, detach the empty magazine and snap in a full magazine in mere seconds • Magnum caliber holds three cartridges • Standard caliber holds four cartridges • Mark II Safari and Lightweight Stalker WSM calibers hold two cartridges

CALIBER	CODE NUMBER	SUGGESTED RETAIL
MARK II SAFARI, LIGHTWEIGHT STALKER		
243 Win. and 308 Win.	112025011	84.99
270 WSM	112025041	
7mm WSM	112025042	
300 WSM	112025030	
LONGTRAC, MARK II SAFARI, LIGHTWEIGHT STALKER, MK 3		
270 Win., 25-06 Rem., 30-06 Sprg.	112025024	84.99
300 Win. Mag.	112025029	
338 Win. Mag.	112025031	
7mm Rem. Mag.	112025027	
SHORTTRAC, MK 3		
243 Win. and 308 Win.	112025050	84.99
7mm-08 Rem.	112025051	
270 WSM	112025055	
7mm WSM	112025055	
300 WSM	112025055	
325 WSM	112025052	

BLR

Flush-mounted detachable box magazine • Capacity of three magnum or four standard cartridges

CALIBER	CODE NUMBER	SUGGESTED RETAIL
SHORT ACTION CALIBERS		
223 Rem.	112026008	99.99
243 Win.	112026011	
308 Win.	112026012	
22-250 Rem.	112026009	
7mm-08 Rem.	112026016	
270 WSM	112026030	
300 WSM	112026041	
7mm WSM	112026031	
325 WSM	112022067	
358 Win.	112026042	
450 Marlin	112026043	
LONG ACTION CALIBERS		
270 Win.	112026024	99.99
30-06 Sprg.	112026026	
7mm Rem. Mag.	112026027	
300 Win. Mag.	112026029	



BUCK MARK RIFLE AND PISTOL

10-round detachable box magazine • Heat treated steel body for long life • Steel coil spring for maximum feeding reliability • Fits both Buck Mark pistols and rifles

CALIBER	CODE NUMBER	SUGGESTED RETAIL
22 LR	112055190	34.99

1911-380 • 1911-22

8-round detachable box magazine for the 1911-380 • 10-round detachable box magazine for the 1911-22 • Heat treated steel body for long life • Steel coil spring for maximum feeding reliability with all types of factory ammunition including modern defensive hollowpoints

	CALIBER	CODE NUMBER	SUGGESTED RETAIL
A	1911-380	112055192	44.99
B	1911-22 LR	112055191	44.99



HI POWER PISTOL

Double-stack magazine design • Available in 13-round or 10-round capacity

CALIBER	CODE NUMBER	SUGGESTED RETAIL
9mm, S.A., H.P., Standard (10-Round Capacity)	112050193	64.99
9mm, S.A., H.P., Pachmayr Pad (10-Round Capacity)	112051193	
40 S&W, S.A., H.P., Standard (10-Round Capacity)	112050194	
40 S&W, S.A., H.P., Pachmayr Pad (10-Round Capacity)	112051194	
9mm, S.A. H.P., Standard (13-Round Capacity)	112050293	79.99
9mm, S.A., H.P., Pachmayr Pad (13-Round Capacity)	112051293	

INTEGRATED SCOPE MOUNT SYSTEM

Browning's Integrated Scope Mount System unitizes the ring and base into a single, ultra-rigid unit. Machined from 7000 series aluminum alloy, they eliminate alignment problems and the possibility of a loose connection between the base and ring. They are available in .400" Standard height, .500" Intermediate height and .600" High height versions to fit many popular Browning firearms.



X-BOLT

HEIGHT	SCOPE DIAMETER Inches/mm	FINISH	CODE NUMBER	SUGGESTED RETAIL
Standard	1	Matte	12501	69.99
Intermediate	1	Matte	12502	
High	1	Matte	12503	
Standard	1	Gloss	12504	
Intermediate	1	Gloss	12505	
High	1	Gloss	12506	
Standard	30	Matte	12510	
Intermediate	30	Matte	12511	
High	30	Matte	12512	



AB3

NEW 2016	HEIGHT	SCOPE DIAMETER Inches/mm	FINISH	CODE NUMBER	SUGGESTED RETAIL
•	Standard	30	Matte	123011	69.99
•	Intermediate	30	Matte	123012	
•	High	30	Matte	123013	
	Standard	1	Matte	12311	
	Intermediate	1	Matte	12312	
	High	1	Matte	12313	



A-BOLT RIFLE/A-BOLT SHOTGUN

HEIGHT	SCOPE DIAMETER Inches	FINISH	CODE NUMBER	SUGGESTED RETAIL
Shotgun Standard	1	Matte	12307	69.99
Standard	1	Gloss	12390	
Standard	1	Matte	12391	
Intermediate	1	Gloss	12392	
Intermediate	1	Matte	12393	
Standard, Super Short Action	1	Matte	12380	
Intermediate, Super Short Action	1	Matte	12381	
Standard, Mountain Ti	1	Matte	12382	
Intermediate, Mountain Ti	1	Matte	12349	



BAR/BLR

HEIGHT	SCOPE DIAMETER Inches	FINISH	CODE NUMBER	SUGGESTED RETAIL
Standard	1	Gloss	12394	69.99
Standard	1	Matte	12377	
Intermediate	1	Gloss	12395	
Intermediate	1	Matte	12376	



T-BOLT

HEIGHT	SCOPE DIAMETER Inches	FINISH	CODE NUMBER	SUGGESTED RETAIL
Standard	1	Matte	12338	69.99



The height is determined by measuring from the top of the base to the bottom of the scope ring. Barrel contour, optic size and preferred eye relief all affect the fit of the scope on a rifle.

STANDARD HEIGHT (.300")
For scopes with an objective up to 44mm and a standard barrel contour.

INTERMEDIATE HEIGHT (.400")
For scopes with an objective up to 50mm and a standard barrel contour.

HIGH HEIGHT (.500")
For scopes with an objective up to 56mm and a standard barrel contour.

SCOPE BASES

Browning scope bases are machined from solid steel • Double recoil shoulder design holds rings securely, even under magnum recoil • T-Bolt two-piece and SA-22 one-piece bases are alloy and are only compatible with Browning rimfire rings (Code 12365) • These bases are only compatible with Browning scope rings listed at right • Maxus, Gold, Silver, BPS, Buck Mark two-piece bases and BLR Takedown one-piece bases are Weaver-style and not compatible with Browning rings.

	HEIGHT	FINISH	CODE NUMBER	SUGGESTED RETAIL
A A-BOLT (TWO-PIECE)				
	Standard	Matte	12331	44.99
	Intermediate	Gloss	12330	
	High	Matte	12332	
BAR, BLR (TWO-PIECE)				
	Standard	Gloss	12332	44.99
T-BOLT (TWO-PIECE)				
	High	Matte	12389	44.99
B SA-22 (ONE-PIECE)				
	Intermediate	Matte	12333	69.99
C X-BOLT (TWO-PIECE)				
	Standard	Matte	12334	49.99
	Intermediate	Gloss	12362	

SCOPE RINGS

Ultra-rigid vertically split rings use oversize hardware for extra strength and ease of installation • Standard, Intermediate and High rings are available for both 1" and 30mm diameter scopes • Compatible with the two-piece scope bases for A-Bolt, BAR, BLR and the X-Lock bases for X-Bolt rifles listed at left • T-Bolt and SA-22 mounts use rimfire rings **RINGS SOLD IN PAIRS**

	HEIGHT	SCOPE DIAMETER Inches/mm	FINISH	CODE NUMBER	SUGGESTED RETAIL
D 1 INCH					
	Standard	1	Matte	12343	99.99
	Intermediate	1	Matte	12344	
	High	1	Matte	12345	
	Standard	1	Gloss	12340	
	Intermediate	1	Gloss	12341	
	High	1	Gloss	12342	
	Standard, Rimfire	1	Matte	12365	
30MM					
	Standard	30	Matte	12346	99.99
	Intermediate	30	Matte	12347	
	High	30	Matte	12348	



WEAVER-STYLE SCOPE BASES

Browning one- and two-piece Weaver-style scope bases are machined from aircraft grade alloy • X-Bolt bases feature a four screw per base mounting platform for a secure fit • Compatible with Browning Weaver-style scope rings listed at right • BLR Takedown bases are Weaver-type, one-piece scout-style bases for forward mounting a long eye-relief scope

	DESCRIPTION	FINISH	CODE NUMBER	SUGGESTED RETAIL
E AB3 (TWO-PIECE)				
	—	Matte	12550	24.99
A-BOLT (TWO-PIECE)				
	—	Gloss	12551	24.99
	—	Matte	12552	
X-BOLT (TWO-PIECE)				
	—	Gloss	12553	24.99
	—	Matte	12554	
F BLR TAKEDOWN (ONE-PIECE)				
	Short Action		12327	79.99
	WSM/LA/Magnum	Matte	12326	
	450 Marlin		12325	
G MAXUS/GOLD/SILVER/BPS (ONE-PIECE)				
	—	Matte	12360	44.99
H BUCK MARK (ONE-PIECE)				
	—	Matte	12328	44.99

WEAVER-STYLE SCOPE RINGS

Standard, Intermediate and High rings are available for both 1" and 30mm diameter scopes • Compatible with the one- and two-piece Weaver-style scope bases for AB3, A-Bolt, X-Bolt, BLR and Buck Mark rifles, and for Maxus, Gold, Silver shotguns as listed at left **RINGS SOLD IN PAIRS**

	HEIGHT	FINISH	CODE NUMBER	SUGGESTED RETAIL
I 1 INCH				
	Standard	Gloss	12555	34.99
	Intermediate	Gloss	12556	
	High	Gloss	12557	
	Standard	Matte	12558	
	Intermediate	Matte	12559	
	High	Matte	12560	
30MM				
	Standard	Gloss	12561	34.99
	Intermediate	Gloss	12562	
	High	Gloss	12563	
	Standard	Matte	12564	
	Intermediate	Matte	12565	
	High	Matte	12566	

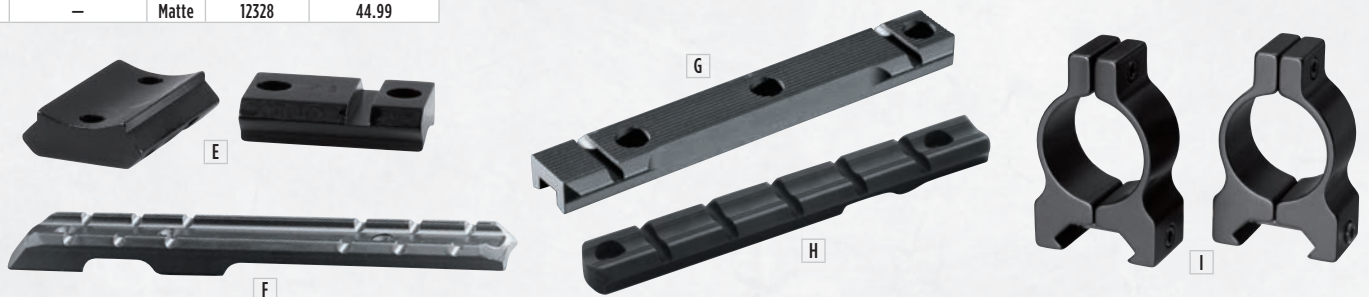

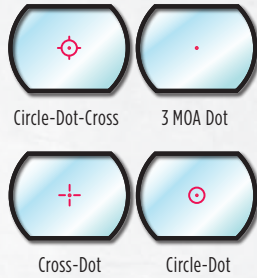

BUCK MARK REFLEX

Four reticle patterns: Circle-Dot-Cross Reticle, 3 MOA Dot Reticle, Cross-Dot Reticle, Circle-Dot Reticle • Seven-position brightness rheostat • Field-of-view: 15.7m/100m • Unlimited eye relief • Powered by one #2032 lithium battery • Mounts to any standard Weaver-style base • Rugged aluminum housing with matte black finish

CODE NUMBER	SUGGESTED RETAIL
1290230	69.99



HIVIZ® BUCK MARK PISTOL

A great performance upgrade for the Buck Mark Plus, Camper, Standard and Micro pistol models • Speeds target acquisition and provides better low-light accuracy • No batteries required • Easy single screw installation to replace factory front sight • No gunsmithing required • Includes six LitePipes; three green, two red and one white

CODE NUMBER	SUGGESTED RETAIL
12875	44.99

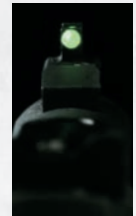

HIVIZ® COMP

Metal base threads directly into the bead of shotguns for a more permanent sight picture • Allows the shooter to know exactly where the barrel is in relation to the target • Interchangeable LitePipes allow shooter to match light pipe diameter and color to shooting conditions • Includes two white, three green and three red LitePipes • Used by top professional shooters • Metal base • Five screw sizes, 3/56, 3x.5, 3x.6, 5/40 and 6/48 to fit most shotguns • LitePipe changing key and custom carrying case are included (not shown)

CODE NUMBER	SUGGESTED RETAIL
12850	39.99

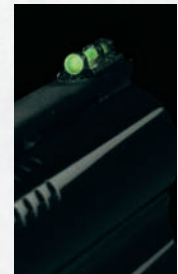

HIVIZ® BIRD BUSTER MAGNETIC SHOTGUN

HiViz Bird Buster magnetic sights come with four interchangeable LitePipes of different diameters to match different lighting conditions • Includes three sizes of magnetic bases to fit the rib of virtually any shotgun • Mounts easily with no gunsmithing required • Fits all Browning shotguns

CODE NUMBER	SUGGESTED RETAIL
12859	24.99



HIVIZ® 2-IN-1 SHOTGUN

High strength magnetic base attaches directly to shotgun rib • Each sight features both red and green LitePipes • Simply reverse the sight to change the color the shooter sees • Comes with both round and triangular LitePipe systems • Hunter model is designed specifically for shotguns with narrow ribs • Sporter model is designed specifically for shotguns with wider ribs • No gunsmithing required

MODEL	CODE NUMBER	SUGGESTED RETAIL
(HIVIZ 2-1 HUNTING SIGHT SHOWN)		
HiViz 2-1 Hunting Sight	12871	29.99
HiViz 2-1 Sporting Sight	12872	

FINE TUNE FOR FULL POWER ACCURACY WITH THE BROWNING BOSS.

When you're trying to wring maximum accuracy out of your rifle, often your only choices are to find a factory load that gives acceptable accuracy or to experiment with custom handloads that give great accuracy, but often at the cost of less than maximum velocity. Both are expensive and time consuming endeavors. But if you use the Browning BOSS you can pick the right ammo for your hunt or long-range match and simply dial up maximum accuracy without sacrificing maximum velocity for greater downrange stopping power and improved bullet stability.

BOSS-CR ACCESSORY

The BOSS-CR accessory offers all the accuracy and tunable advantages of the original BOSS device without the muzzle brake feature. By simply replacing the original BOSS forward weight and recoil reduction components with the one-piece, non-ported BOSS-CR accessory, only the reduced recoil of the original BOSS is sacrificed. The BOSS-CR accessory is designed to fit only BAR Mark II and A-Bolt centerfire rifles previously factory-fitted with the BOSS. **GLOSS BLUED** for BAR Safari; A-Bolt models: Medallion and Gold Medallion **MATTE BLUED** for A-Bolt models: Composite Stalker, Hunter, Euro-Bolt, Varmint, Eclipse Hunter and M-1000 Eclipse **STAINLESS** for A-Bolt models: Stainless Stalker, White Gold Medallion and M-1000 Eclipse **IT IS IMPORTANT THAT THE CORRECT BOSS-CR BE SELECTED FOR A SPECIFIC CALIBER AND MODEL OF RIFLE.**

DESCRIPTION	SUGGESTED RETAIL
Gloss Blued	39.99
Matte Blued	
Stainless	



CALIBER	GLOSS BLUED	MATTE BLUED	STAINLESS
	CODE NUMBER	CODE NUMBER	CODE NUMBER
223 Rem.	1140011	1140012	1140013
223 Varmint	1140061	1140062	—
223 WSSM	1140011	1140012	1140013
243 WSSM	1140011	1140012	1140013
25 WSSM	1140011	1140012	1140013
22-250 Rem.	1140011	1140012	1140013
22-250 Varmint	1140061	1140062	—
22-250 Varmint (M-1000)	—	1140062	1140063
243 Win.	1140011	1140012	1140013
7mm-08 Rem.	1140011	1140012	1140013
308 Win.	1140021	1140022	1140023
308 Varmint	1140061	1140062	—
308 Varmint (M-1000)	—	1140062	1140063
25-06 Rem.	1140011	1140012	1140013
260 Rem.	1140011	1140012	1140013
270 WSM	1140021	1140022	1140023
270 Win.	1140011	1140012	1140013
280 Rem.	1140011	1140012	1140013
30-06 Sprg.	1140031	1140032	1140033
7mm WSM	1140021	1140022	1140023
7mm Rem. Mag.	1140021	1140022	1140023
300 WSM	1140041	1140042	1140043
300 WSM (M-1000)	—	1140092	1140093
300 Win. Mag.	1140041	1140042	1140043
300 Win. Mag. (M-1000)	—	1140092	—
325 WSM	1140051	1140052	1140053
338 Win. Mag.	1140051	1140052	1140053
375 H&H Mag.	1140071	—	1140073



DON'T CHOKE UP WHEN SELECTING THE RIGHT CHOKE TUBE.

You know that the right choke tube constriction for a specific hunting situation or challenging target presentation is the key to making a successful shot. This information will help you make the best choice from the wide selection of Browning choke tubes. Our tubes range from Extra-Full constrictions for turkey, coyote and goose hunters to pattern-spreading Timber n' Teal tubes for close-in flooded timber waterfowling. Remember that every Browning choke tube is made to exacting standards to provide you with a perfect, dense and even shot pattern and many years of dependable service.

INVECTOR-DS

INVECTOR-DS CHOKE SYSTEM

- Invector-DS choke tubes combine muzzle-end threads and thin-wall construction for a longer, more gradual taper that produces extremely consistent, dense shot patterns that tighten consistently in reliable, evenly scaled steps.
- Muzzle threads minimize the flare at the end of the barrel for improved appearance, a faster swing and improved balance.
- A proprietary differential-banded brass seal compresses against the barrel wall when tightened to keep the choke tube threads clean and make installation and removal easier than any other muzzle thread system.
- Invector-DS is standard on A5 and Citori 725 models.
- View the full line of Invector-DS choke tubes on pages 175 and 177.

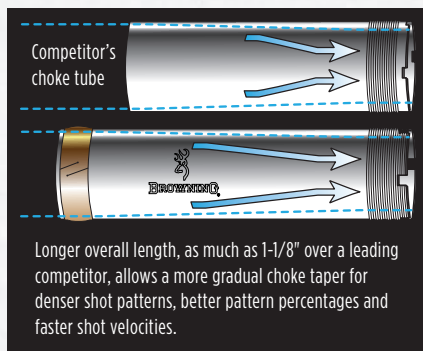
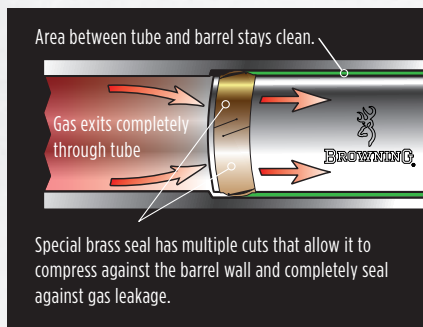

INVECTOR-Plus™

INVECTOR-PLUS CHOKE SYSTEM

- The Invector-Plus interchangeable choke tube system works with Vector Pro and back-boring to offer consistent, dense shot patterns.
- The longer choke taper inside an Invector-Plus choke tube produces consistent patterns and is far more durable than choke systems in competitors' guns, especially with steel shot.
- Invector-Plus eliminates gases slipping between the choke tube and barrel that could damage the choke tube and the barrel.
- Invector-Plus is standard on 12 and 20 gauge Maxus, Citori, Cynergy, Silver, BPS and BT-99 models.
- See pages 175 through 179 for a complete listing of choke tubes and choke tube wrenches.

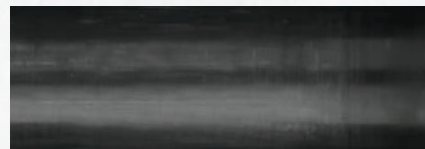

Browning's Invector choke tube is still flawless after 500 rounds of steel shot.

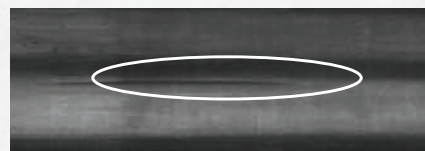

The competitor's choke tube is grooved and pitted after shooting 500 rounds of steel shot.

STANDARD INVECTOR™

STANDARD INVECTOR

- The Standard Invector interchangeable choke tube system is for Browning's non back-bored barrels and offers consistent, dense shot patterns. It's far more durable than the choke systems found in competitors' guns, especially with steel shot.
- Standard Invector eliminates gases slipping between the choke tube and barrel that could damage the choke tube and the barrel and it's standard on 10, 16 and 28 gauge, and .410 bore Citori, Cynergy, Gold and BPS models.
- See pages 175 through 179 for a complete listing of choke tubes and choke tube wrenches.

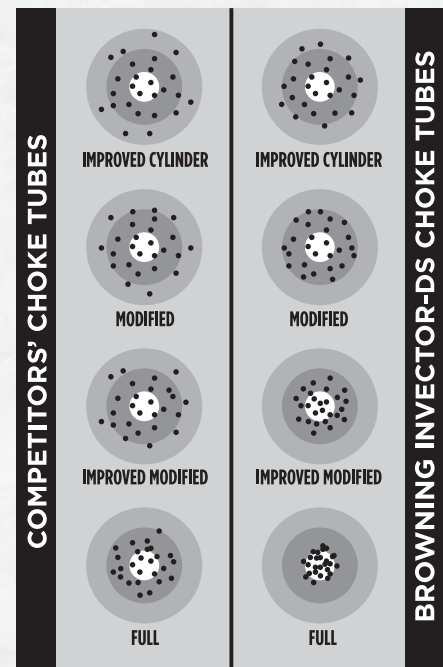

INVECTOR-DS CHOKE TUBES VS. COMPETITORS' CHOKE TUBES

Invector-DS tubes have even pattern percentage increments, offering just the right pattern for any shooting situation.

Competitors' choke tubes show little pattern difference between choke constrictions.



INVECTOR-DS EXTENDED CHOKE TUBES

Extended length tubes are easy to change and add approximately 3/4" to the overall length of the barrel • Proprietary differential banded brass gas seal eliminates residue build up and makes chokes easy to remove and install • Integrated spring suspension holds the seal tight, yet allows expansion against the barrel wall for a perfect fit and a smooth transition for shot column entering choke • Gas is controlled at the interface between choke and where it seats in the bore • From Skeet to Full choke, patterns tighten consistently and reliably • Choke tube wrenches are listed on page 179 • Flat choke tube wrench is not compatible with Invector-DS choke tubes

DESCRIPTION	PATTERN PERCENTAGE	12 GAUGE CODE NUMBER	20 GAUGE CODE NUMBER	SUGGESTED RETAIL
Full	75-80%	1134253	1134255	69.99
Light Full	70-75%	1134243	1134245	
Improved Modified	65-75%	1134263	1134265	
Modified	55-65%	1134273	1134275	
Light Modified	45-55%	1134233	1134235	
Improved Cylinder	40-45%	1134283	1134285	
Skeet	35-40%	1134293	1134295	

INVECTOR-DS



INVECTOR-DS FLUSH CHOKE TUBES

Standard tubes fit flush with the end of the barrel but are longer than competitors' tubes • Proprietary differential banded brass gas seal eliminates residue build up and makes chokes easy to remove and install • Integrated spring suspension holds the seal tight, yet allows expansion against the barrel wall for a perfect fit and a smooth transition for shot column entering choke • Gas is controlled at the interface between choke and where it seats in the bore • From Skeet to Full choke, patterns tighten consistently and reliably • Choke tube wrenches are listed on page 179 • Flat choke tube wrench is not compatible with Invector-DS choke tubes

DESCRIPTION	PATTERN PERCENTAGE	12 GAUGE CODE NUMBER	16 GAUGE CODE NUMBER	20 GAUGE CODE NUMBER	SUGGESTED RETAIL
Full	75-80%	1133253	1133216	1133255	44.99
Light Full	70-75%	1133243	1133226	1133245	
Improved Modified	65-75%	1133263	1133236	1133265	
Modified	55-65%	1133273	1133246	1133275	
Light Modified	45-55%	1133233	1133256	1133235	
Improved Cylinder	40-45%	1133283	1133266	1133285	
Skeet	35-40%	1133293	1133276	1133295	

INVECTOR-DS



MIDAS GRADE EXTENDED CHOKE TUBES

Extends beyond the end of barrel for easy removal and installation • Stainless steel with black oxide finish • Laser-etched gold accent band • Minimum gap geometry plus high-resolution "RMS" finish reduce plastic build up in bore • Invector-Plus long taper choke tube technology in 12 and 20 gauge • Produces tighter patterns than Browning Invector-Plus flush choke tubes • 28 gauge and .410 bore are Standard Invector chokes • Choke tube wrenches are listed on page 179 • Flat choke tube wrench is not compatible with Midas Grade Extended Choke Tubes

DESCRIPTION	PATTERN PERCENTAGE	12 GAUGE CODE NUMBER	20 GAUGE CODE NUMBER	28 GAUGE CODE NUMBER	.410 BORE CODE NUMBER	SUGGESTED RETAIL
Extra-Full Trap	75-85%	1130123	—	—	—	59.99
Full	55-85%	1130153	1130653	1130953	1131153	
Improved Modified	45-75%	1130163	1130663	1130063	1131163	
Modified	35-65%	1130173	1130673	1130073	1131173	
Light Modified	30-60%	1130133	1130633	1130033	1131133	
Improved Cylinder	25-55%	1130183	1130683	1130083	1131183	
Skeet	20-45%	1130193	1130693	1130993	1131193	
Cylinder	20-45%	1130113	—	—	—	84.99
Spreader*	—	1130103	—	—	—	

* Helically rifled to spin the shot charges and spread the pattern

STANDARD
INVECTOR™ *INVECTOR-Plus*™



DIAMOND GRADE EXTENDED CHOKE TUBES

Longer choke taper inside Invector-Plus choke tubes for use with back-bored barrels on 12 and 20 gauge shotguns • Matching tubes for the Citori 625 Sporting • 17-4 stainless steel construction • Absolutely perfect concentricity for superior patterning • Diamond-cut knurling extends beyond the end of the barrel for easy removal and installation • Titanium nitride finish with black accent band • 28 gauge and .410 bore are Standard Invector chokes • Choke tube wrenches are listed on page 179 • Flat choke tube wrench is not compatible with Diamond Grade Extended Choke Tubes

DESCRIPTION	PATTERN PERCENTAGE	12 GAUGE	20 GAUGE	28 GAUGE	.410 BORE	SUGGESTED RETAIL
		CODE NUMBER	CODE NUMBER	CODE NUMBER	CODE NUMBER	
Full	55-85%	1134153	1135153	1136153	1137153	94.99
Improved Modified	45-75%	1134163	1135163	1136163	1137163	
Modified	35-65%	1134173	1135173	1136173	1137173	
Light Modified	30-60%	1134133	1135133	1136133	1137133	
Improved Cylinder	25-55%	1134183	1135183	1136183	1137183	
Skeet	20-45%	1134193	1135193	1136193	1137193	
Cylinder	15-45%	1134113	1135113	1136113	1137113	

STANDARD
INVECTOR™ *INVECTOR-Plus™*



DIANA GRADE EXTENDED CHOKE TUBES

Longer choke taper inside Invector-Plus choke tubes for use with back-bored barrels on 12 and 20 gauge shotguns • Stainless steel barstock is heat treated prior to machining • Titanium nitride surface 72HRC hardness for excellent wear and reduced plastic buildup • Absolutely perfect concentricity for superior patterning • Extends beyond the barrel for easy removal and installation • Produces tighter patterns than Browning Invector-Plus flush choke tubes • 28 gauge are Standard Invector chokes • Choke tube wrenches are listed on page 179 • Flat choke tube wrench is not compatible with Diana Grade Extended Choke Tubes

DESCRIPTION	PATTERN PERCENTAGE	12 GAUGE	20 GAUGE	28 GAUGE	SUGGESTED RETAIL
		CODE NUMBER	CODE NUMBER	CODE NUMBER	
Full	55-85%	1130553	1131053	1132153	74.99
Improved Modified	45-75%	1130563	1131063	1132163	
Modified	35-65%	1130573	1131073	1132173	
Light Modified	30-60%	1130533	1131033	1132133	
Improved Cylinder	25-55%	1130583	1131083	1132183	
Skeet	20-45%	1130593	1131093	1132193	
Cylinder	15-45%	1130513	—	—	
Spreader*	—	1130503	—	—	99.99

* Helically rifled to spin the shot charges and spread the pattern

STANDARD
INVECTOR™ *INVECTOR-Plus™*



INVECTOR-PLUS EXTENDED CHOKE TUBES

Constructed of highly polished stainless steel for the ultimate in performance and durability • Knurled portion extends beyond the end of the barrel for easy removal and installation • Longer choke taper inside for use with back-bored barrels • Produces excellent shot patterns with uniform densities • Set to industry constriction patterns • Threaded for 12 gauge Browning Invector-Plus back-bored barrels only • Available in six constrictions from Skeet to Full • Choke tube wrenches are listed on page 179

DESCRIPTION	PATTERN PERCENTAGE	12 GAUGE	SUGGESTED RETAIL
		CODE NUMBER	
Full	55-85%	1132253	49.99
Improved Modified	45-75%	1132263	
Modified	35-65%	1132273	
Light Modified	30-60%	1132233	
Improved Cylinder	25-55%	1132283	
Skeet	20-45%	1132293	

INVECTOR-Plus™



SPECIALTY EXTENDED CHOKE TUBES

Constructed of stainless steel for the ultimate in performance and durability • Knurled portion extends beyond the end of the barrel for easy removal and installation • Full Strut Turkey tube has directional porting, a camo front band and is optimized for tight patterns with #4, #5 and #6 shot sizes • Express Sabot Rifled tube has a red front band and is rifled to produce optimal accuracy from both Foster and sabot slugs • Investor-DS Turkey tube has a black accent band and an extra full constriction for improved long range patterning • Choke tube wrenches are listed on page 179 • Flat choke tube wrench is not compatible with Specialty Extended Choke Tubes

	DESCRIPTION	PATTERN PERCENTAGE	12 GAUGE CODE NUMBER	SUGGESTED RETAIL
A	Investor-Plus Full Strut Turkey	80-85%	1130500	99.99
B	Investor-Plus Express Sabot	—	1130863	
C	Investor-DS Turkey	80-85%	1134203	69.99

INVECTOR-Plus™ *INVECTOR-DS*

A

B

C



WICKED WING EXTENDED CHOKE TUBES

Investor-Plus Wicked Wing choke tubes are available in three constrictions for close, medium and long range shooting • Specifically designed for steel shot, particularly Winchester® Blind Side® ammunition • Longer choke taper inside Investor-Plus choke tubes for use with back-bored barrels • Constructed of 17-4 stainless steel for the ultimate in performance and durability • Long Range tube produces a 70% pattern • Medium Range tube produces a 50% pattern • Close Range tube produces a 30% pattern • Two pack includes both Long and Close Range tubes • Choke tube wrenches are listed on page 179 • Flat choke tube wrench is not compatible with Wicked Wing Extended Choke Tubes

DESCRIPTION	PATTERN PERCENTAGE	12 GAUGE CODE NUMBER	SUGGESTED RETAIL
Long Range	70%	1130315	69.99
Medium Range	50%	1130316	
Close Range	30%	1130317	
2-Pack	—	1130318	119.99



INVECTOR-Plus™



GRAND PASSAGE EXTENDED CHOKE TUBES

Mossy Oak® camo band • Stainless steel with black oxide finish • Superior patterning with steel shot • Threaded for 12 gauge Investor-Plus back-bored barrels only • Produces tighter patterns than Browning Investor-Plus flush choke tubes • Timber n' Teal model is helically spun to spin shot, making it excellent for tight timber, teal and close range shooting • Choke tube wrenches are listed on page 179 • Flat choke tube wrench is not compatible with Grand Passage Extended Choke Tubes

DESCRIPTION	PATTERN PERCENTAGE	12 GAUGE CODE NUMBER	SUGGESTED RETAIL
Full	55-85%	1131453	74.99
Improved Modified	45-75%	1131463	
Modified	35-65%	1131473	
Light Modified	30-60%	1131433	
Improved Cylinder	25-55%	1131483	
Timber n' Teal*	—	1131493	94.99

* Helically rifled to spin the shot charges and spread the pattern

INVECTOR-Plus™



INVECTOR-PLUS CHOKE TUBES

Invector-Plus tubes are available in constrictions ranging from Cylinder to Extra-Full • Longer choke taper inside Invector-Plus choke tubes for use with back-bored barrels • Produces excellent patterns with uniform densities • Made to industry constriction standards • Flush fit tubes do not extend beyond end of barrel (Except X-Full Turkey and X-Full Trap models) • Constructed of highly polished, 17-4 stainless steel for the ultimate in performance and durability

DESCRIPTION	PATTERN PERCENTAGE	12 GAUGE CODE NUMBER	20 GAUGE CODE NUMBER	SUGGESTED RETAIL
X-Full Turkey/Trap Spcl. (Extended Tube)	75-85%	1130833	—	69.99
Full	55-85%	1130753	1130755	34.99
Improved Modified	45-75%	1130763	—	
Modified	35-65%	1130773	1130775	
Improved Cylinder	25-55%	1130783	1130785	
Skeet	20-45%	1130793	1130795	
Cylinder	15-45%	1130803	1130805	

INVECTOR-Plus™



STANDARD INVECTOR CHOKE TUBES

Standard Invector tubes are available in constrictions ranging from Cylinder to Extra-Full • Produces excellent patterns with uniform densities • Made to industry constriction standards • Flush fit tubes do not extend beyond end of barrel (Except X-Full Trap and X-Full Turkey models) • Constructed of highly polished, 17-4 stainless steel for the ultimate in performance and durability

DESCRIPTION	PATTERN PERCENTAGE	10 GAUGE CODE NUMBER	SUGGESTED RETAIL
10 GAUGE			
X-Full Turkey/Trap Spcl.	75-85%	1130311	49.99
Full	55-85%	1130251	
Modified	35-65%	1130271	
Improved Cylinder	25-55%	1130281	

DESCRIPTION	PATTERN PERCENTAGE	12 GAUGE CODE NUMBER	16 GAUGE CODE NUMBER	SUGGESTED RETAIL
12 AND 16 GAUGE				
X-Full Trap Special (Extended Tube-12 Ga.)	75-85%	1130323	—	69.99
X-Full Turkey/Trap Spcl. (Extended Tube-12 Ga.)	75-85%	1130343	—	34.99
Rifled Deer Spcl. Matte	—	1130363	—	
Full	55-85%	1130253	1130254	
Improved Modified	45-75%	1130263	—	
Modified	35-65%	1130273	1130274	
Improved Cylinder	25-55%	1130283	1130284	
Skeet	20-45%	1130293	1130294	34.99
Cylinder	15-45%	1130303	1130304	

DESCRIPTION	PATTERN PERCENTAGE	20 GAUGE CODE NUMBER	28 GAUGE CODE NUMBER	.410 BORE CODE NUMBER	SUGGESTED RETAIL
20 AND 28 GAUGE AND .410 BORE					
Full	55-85%	1130255	1130256	1130257	34.99
Modified	35-65%	1130275	1130276	1130277	
Improved Cylinder	25-55%	1130285	1130286	1130287	
Skeet	20-45%	1130295	1130296	1130297	
Cylinder	15-45%	1130305	—	—	

**STANDARD
INVECTOR™**



SPEED WRENCH



T-WRENCH



WRENCH

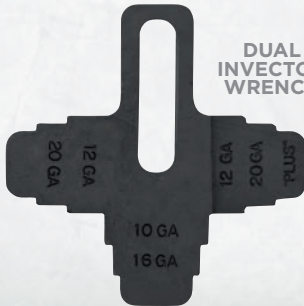

DUAL INVECTOR WRENCH

INVECTOR-PLUS WRENCHES

DESCRIPTION	12 GAUGE	20 GAUGE	SUGGESTED RETAIL
	CODE NUMBER	CODE NUMBER	
12 AND 16 GAUGE			
T-Wrench†	1130023	1130035	24.99
Speed Wrench	1130060	—	44.99
Wrench*	1130053	—	12.99
Dual Invector Wrench*	1130050	1130050	14.99

* NOT RECOMMENDED FOR USE WITH EXTENDED CHOKE TUBES.
 † T-WRENCH DOES NOT WORK WITH INVECTOR-DS CHOKE TUBES.

STANDARD INVECTOR WRENCHES

DESCRIPTION	10 GAUGE	SUGGESTED RETAIL
	CODE NUMBER	
10 GAUGE		
T-Wrench†	—	—
Wrench*	1130048	12.99
Dual Invector Wrench*	1130050	14.99

DESCRIPTION	12 GAUGE	16 GAUGE	SUGGESTED RETAIL
	CODE NUMBER	CODE NUMBER	
12 AND 16 GAUGE			
T-Wrench†	1130013	—	24.99
Wrench*	1130048	1130048	12.99
Dual Invector Wrench*	1130050	1130050	14.99

DESCRIPTION	20 GAUGE	28 GAUGE	.410 BORE	SUGGESTED RETAIL
	CODE NUMBER	CODE NUMBER	CODE NUMBER	
20 AND 28 GAUGE AND .410 BORE				
T-Wrench†	1130035	1130016	1130017	24.99
Wrench*	1130048	—	—	12.99
Dual Invector Wrench*	1130050	—	—	14.99

* NOT RECOMMENDED FOR USE WITH EXTENDED CHOKE TUBES.
 † T-WRENCH DOES NOT WORK WITH INVECTOR-DS CHOKE TUBES.



MIDAS ELECTRONIC HEARING PROTECTOR

Sharp noises like gunfire are reduced while normal speech and ambient sounds are amplified • On/off volume controls • Fast reaction time of just 6 milliseconds • Operates on two AA batteries (not included) • LED battery charge indicator • 100-120 hours of use per set of batteries • NRR 28dB

CODE NUMBER	SUGGESTED RETAIL
12627	79.99



JUNIOR BUCKMARK HEARING PROTECTOR

Adjustable-fit earmuffs with padded headband for added comfort • Meets ANSI S3.19 noise reduction standards • Reduced size to better fit smaller heads • Light weight makes them ideal for all day wear • NRR 19dB • High Visibility Green color

CODE NUMBER	SUGGESTED RETAIL
126372	24.99

HDR HEARING PROTECTOR

Our best hearing earmuff provides a noise reduction rating of 37dB • Soft, comfortable foam earcups • Padded and adjustable headband

CODE NUMBER	SUGGESTED RETAIL
12699	44.99



BLACK LABEL EVADER II HEARING PROTECTOR

Adjustable-fit earmuffs with padded headband for added comfort • Meets ANSI S3.19 noise reduction standards • NRR 26 dB • Black/gray frame with carbon fiber finish

CODE NUMBER	SUGGESTED RETAIL
12689	44.99



ECLIPSE HEARING PROTECTOR

Unique black and gold earcups look great with one's favorite Browning guns and gear • Adjustable, padded headband folds to take up less space in a gear bag • Soft foam-padded earcups • NRR 31dB

CODE NUMBER	SUGGESTED RETAIL
12684	29.99

BUCKMARK II HEARING PROTECTOR

Pick the color or pattern on earcups for a great look with any gun or gear • Soft, comfortable foam earcups • Foldable padded headband • Meets ANSI S3.19 noise reduction standards • NRR 26 dB

DESCRIPTION	CODE NUMBER	SUGGESTED RETAIL
A Black	12682	24.99
B MOINF	12688	44.99
C Olive	126384	
D For Her, Pink	12687	24.99
E For Her, Purple	126396	
F For Her, Leopard	126332	44.99
G For Her, Zebra	126339	





A

RANGE KITS

Shooting glasses with tinted polycarbonate lenses offer both eye protection and enhanced target visibility • Soft foam earplugs provide noise reduction up to 31dB and come with a plastic storage case (shown) • Adjustable-fit earmuffs with padded headband • NRR 27dB **JUNIOR** Wrap-around polycarbonate lens exceeds ANSI Z87.1 impact standards • Black temples with rubber tips for a secure, pressure-free fit • 15% size reduction from adult models to better fit smaller faces • Adjustable-fit High Visibility Green earmuffs with padded headband for added comfort • Meets ANSI S3.19 noise reduction standards • Reduced size to better fit smaller heads • NRR 19dB

	DESCRIPTION	CODE NUMBER	SUGGESTED RETAIL
A	Black	126368	34.99
B	For Her	126373	
C	Junior	126371	



B



C



BLACK LABEL TACTICAL RANGE KIT II

Shooting glasses with tinted polycarbonate lenses provide both outstanding eye protection plus enhanced target visibility under various lighting conditions • Soft foam earplugs provide noise reduction up to 31 dB and come with a plastic storage case • Adjustable-fit earmuffs with padded headband have a noise reduction rating of 26 dB • Meets ANSI S3.19 noise reduction standards • Black/gray frame with carbon fiber finish

CODE NUMBER	SUGGESTED RETAIL
126374	54.99



BANDED EARPLUGS

Foam earplugs conform to the outer ear canal for a more comfortable fit • Plastic headband fits comfortably around the head or neck • Comes with removable foam plugs • Folds up for easy storage • NRR 22 dB • Includes one pair of replaceable foam earplugs

CODE NUMBER	SUGGESTED RETAIL
12686	8.99



SOUND SHIELD

Tall lens profile and frameless design help eliminate visual distractions and blind spots • Choice of yellow or lightly tinted indoor/outdoor lens • Lenses exceed ANSI Z87.1 impact standards • Soft rubber standoff nosepiece reduces slipping and fogging • Color accented rubberized temples help prevent slipping in hot or humid conditions • End of each earpiece opens to release a corded retractable earplug • Earplugs have an NRR of 25 dB • Earplugs are washable and replaceable

	DESCRIPTION	CODE NUMBER	SUGGESTED RETAIL
A	Men's Large, Yellow	12744	29.99
B	Men's Large, Indoor/Outdoor	12743	
C	Men's Medium Indoor/Outdoor, Lime	12746	
D	Men's Medium Indoor/Outdoor, Orange	12747	
E	For Her, Indoor/Outdoor, Fuchsia	12745	
F	Replacement Earplugs (12 Pack)	12749	19.99



BUCKMARK II SHOOTING GLASSES

High-grade wrap-around polycarbonate lenses exceed ANSI Z87.1 impact standards • Buckmark etched in left lens • Lens profile offers maximum field of vision • Choice of smoke, vermilion, yellow or clear lens • Matte black frame • For Her glasses have pink frame with black temple insert and a special lens profile • Built-in rubber nosepiece • Vented temples with rubber tips for a secure, pressure-free fit • Extreme styling for versatile wear • Imprinted microfiber storage bag included (not shown)

	DESCRIPTION	CODE NUMBER	SUGGESTED RETAIL
A	For Her, Vermilion	12723	19.99
B	Vermilion	12724	
C	Clear	12725	
D	Yellow	12726	



CLAYMASTER SHOOTING GLASSES

High-grade polycarbonate lenses offer 99% UV protection
 • Interchangeable orange, yellow, clear, smoke and blue colored lenses included
 • Fully adjustable frames include ratchet pitch adjustment, expandable temple length and height adjustable nose pads
 • Padded case and microfiber bag are included (not shown)

CODE NUMBER	SUGGESTED RETAIL
12715	44.99



BLACK LABEL ARBITRATOR TACTICAL GLASSES

Lightweight, low-profile tactical glasses • 9.5 base curve polycarbonate lens for enhanced side protection • Meets ANSI Z87.1-2003 impact standards • 99% UV protection • Soft PVC nosepiece prevents slipping
 • Polycarbonate frame for strength and durability • Black/gray frame with carbon fiber pattern in choice of smoke, yellow or clear lens

	DESCRIPTION	CODE NUMBER	SUGGESTED RETAIL
A	Smoke	12768	19.99
B	Yellow	12769	
C	Clear	12770	



BLACK LABEL LANDING ZONE TACTICAL GLASSES

Lightweight, low-profile tactical glasses • Zeiss® interchangeable 8 base curve single polycarbonate lens for superior clarity and enhanced side protection • Meets ANSI Z87.1-2003 impact standards • Soft TPR nosepiece for all day comfort • Polycarbonate frame and dual injected earpieces with soft rubber tips for non-slip fit • Black/gray carbon fiber pattern frame with clear, yellow and smoke lens sets included • Includes zipper case

CODE NUMBER	SUGGESTED RETAIL
12771	84.99



GUN CLEANING MAT

The safe way to protect both firearms and furniture • Soft, felt-like fabric won't damage firearms • Waterproof Zorb Tech™ backing stops spills from migrating and inhibits the soak-through of cleaners • Mat measures 16" x 54" for plenty of working room while keeping small parts in their place and organized • Washable, dryable and highly stain-resistant • Shotgun shown is not included

CODE NUMBER	SUGGESTED RETAIL
12420	29.99

**32-PIECE GUN CLEANING KIT**

3-piece brass cleaning rod with machined aluminum handle • Includes bronze brushes, mops, slot-tip jags and adaptors • Cleaning pick and double-ended utility brush • Polishing cloth and 25 cloth cleaning patches • Custom-fit EVA soft-sided case with removable bandoliers and accessory pouches

CODE NUMBER	SUGGESTED RETAIL
12445	54.99

SCREWDRIVER TOOL SET

51-piece tool set is compact and convenient • Custom-molded driver handle with magnetic tip • 12 flat head bits, 8 hex bits, 4 Phillips bits, 2 extra-long Phillips bits, 7 Torx® bits, 4 Robertson bits, 4 Tri-wing bits, 3 Clutch bits, 2 Spline bits, 3 Torq bits and one 1/4" socket adaptor • Rugged double-injected fitted plastic case with clear lid and sliding closure • Ideal for hunting cabin, work bench or gun box

CODE NUMBER	SUGGESTED RETAIL
12401	34.99

**UNIVERSAL CLEANING KIT**

35-piece kit is packaged in a fitted aluminum-frame carry case with molded handle • Includes two sets of sectioned brass cleaning rods: One for small caliber rifles and pistols (.17-.280) and one for large caliber rifles, pistols (.30 and larger) and shotguns • Ten bronze brushes, .17-.45 caliber including three shotgun brushes 12 gauge, 20 gauge, and .410 bore • Six wool mops from .17 caliber to 12 gauge • Six jags, two slotted patch holders, brush adaptors, one PSH handle, handle adaptor and 50 fabric cleaning patches

CODE NUMBER	SUGGESTED RETAIL
12444	69.99

SNAP CAPS

Precisely matches the dimensions of live 12 gauge shells • Offers a safe way to practice trigger pull • Withstands repeated dry-firing practice • Will not harm firing pins or chambers • Sold in pairs

CODE NUMBER	SUGGESTED RETAIL
12465	34.99



PRE-PACKAGED 4-STEP GUN CLEANER

Includes Carbon Cleaner, Bore Polish, 10 oz. Solvent Degreaser and Gun Oil • Great for range bag, work bench or as a gift for the avid shooter

CODE NUMBER	SUGGESTED RETAIL
123400	49.99



STEP 1: CARBON REMOVER

Proprietary formula quickly removes carbon build up
 • Evaporates quickly • Contains no ammonia, pH neutral
 • Pinpoint applicator • 4 oz. bottle

CODE NUMBER	SUGGESTED RETAIL
124023	14.99



STEP 2: BORE POLISH

Proprietary formula improves bore condition while safely removing accuracy-harming copper build up • Removes copper, lead and powder residue • Evaporates quickly • Contains no ammonia, pH neutral
 • Pinpoint applicator • 4 oz. bottle

CODE NUMBER	SUGGESTED RETAIL
124024	17.99



STEP 3: SOLVENT AND DEGREASER

Safely removes residue from Carbon and Bore Polish cleaners
 • Fast-drying solvent displaces water • Contains no chlorine, ozone safe • Rapidly cuts through oil and grease • Leaves no residue • 19 fl. oz. aerosol can

CODE NUMBER	SUGGESTED RETAIL
124025	14.99

STEP 4: GUN OIL

Proprietary formula passes strict military requirements • Low surface tension provides excellent lubrication and corrosion protection • Contains no synthetics
 • 2 oz. bottle with pinpoint applicator or 6 fl. oz. aerosol can

	DESCRIPTION	CODE NUMBER	SUGGESTED RETAIL
A	2 oz.	124032	9.99
B	6 oz.	124040	17.99



NEW
3 FOOT
AND
5 FOOT

BUCKMARK SOLID COLOR



NEW 2016	DESCRIPTION	SIZE Inches	CODE NUMBER	SUGGESTED RETAIL
(SHOWN IN PINK)				
	Purple	6	3922009616	6.99
	Teal	6	3922007416	
	White	4	3922004714	3.99
	White	6	3922004716	6.99
	White	12	3922004711	14.99
	Silver	4	3922005914	3.99
	Silver	6	3922005916	6.99
	Black	4	3922009914	3.99
	Black	6	3922009916	6.99
•	Black	36	3922370399	59.99
•	Black	60	3922370599	79.99
	Pink	6	3922004116	6.99
	Pink	12	3922004111	14.99
	Lime Green	6	3922000654	6.99
	Hot Pink	6	3922005116	6.99
	Gold	4	3922007314	3.99
	Gold	6	3922007316	6.99
	Gold	12	3922007311	14.99
	Chrome Silver	6	3922006916	6.99



NEW
3 FOOT
AND
5 FOOT

BUCKMARK CAMO

NEW 2016	DESCRIPTION	SIZE Inches	CODE NUMBER	SUGGESTED RETAIL
(SHOWN IN MOSSY OAK BREAK-UP INFINITY)				
	Camo	4	3922001914	3.99
	Camo	6	3922002916	6.99
	Camo	12	3922002911	14.99
•	Camo	36	3922370334	59.99
•	Camo	60	3922370534	79.99
	Paint-Safe, MOINF	15	3922281520	14.99
	Paint-Safe, RTX	15	3922282420	



BUCKMARK SPECIALTY AND GRAPHICS

	DESCRIPTION	SIZE Inches	CODE NUMBER	SUGGESTED RETAIL
REFLECTIVE				
A	Amber	6	3922070642	6.99
B	Red	6	3922070661	
CARBON FIBER				
C	Charcoal	6	3922750689	6.99
FALINE SPANGLE				
D	Pink	15	3922220647	12.99
E	Silver	15	3922220659	
SAHARA				
F	Leopard/Purple	6	3922240602	6.99
G	Zebra/Fuchsia	6	3922240609	
RED/WHITE/BLUE				
H	Red/White/Blue	6	3922003116	6.99
		12	3922003111	14.99



BUCKMARK 3D

DESCRIPTION	SIZE Inches	CODE NUMBER	SUGGESTED RETAIL
(SHOWN IN RED/WHITE/BLUE)			
Gold	6	3922017316	14.99
Silver	6	3922015916	
Black	6	3922019916	
MOINF	6	3922012916	
Red/White/Blue	6	3922013116	



Gold



Silver



Black

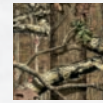

Mossy Oak
Break-Up Infinity



BUCK HEART

DESCRIPTION	SIZE Inches	CODE NUMBER	SUGGESTED RETAIL
A H&H Camo	6	3922290614	8.99
B Camo	6	3922290620	
C Zebra	6	3922290639	
D Hot Pink	6	3922290651	



BUCKMARK FAMILY

DESCRIPTION	SIZE Inches	CODE NUMBER	SUGGESTED RETAIL
MOBU/Pink	6	3922100014	24.99



HELL'S CANYON

DESCRIPTION	SIZE Inches	CODE NUMBER	SUGGESTED RETAIL
A White	4	3922354474	6.99
B Flame	4	3922354324	
C Flame/White	4	3922354304	



HEARTBREAKER 

DESCRIPTION	SIZE Inches	CODE NUMBER	SUGGESTED RETAIL
A Teal/White	5	3922351574	7.99
B Pink/White	5	3922351551	
C White	5	3922351547	



ALL SEASONS

DESCRIPTION	SIZE Inches	CODE NUMBER	SUGGESTED RETAIL
White	12	3922601247	14.99



SHEDS

DESCRIPTION	SIZE Inches	CODE NUMBER	SUGGESTED RETAIL
White	6	3922401647	8.99







**THE SHARPEST DESIGNS
COME FROM BROWNING.**

2016's eye-catching examples of the bladesmithing arts are among the finest and most unique that we have ever offered. It's what makes the Browning brand so highly regarded by everyone from the world's most demanding bladesmen to the casual weekend outdoorsman.

Some people will want to own these jewel-like examples for the pure enjoyment of their tasteful design, craftsmanship and quality. Others will want to add them to a growing knife collection. And some need them for their rugged utility as they travel far afield, riding the high range with confidence because they carry a genuine Browning knife on their belt.

Wherever you may roam, you'll want a trusted Browning blade along for the ride. You know that they are knives that will be treasured, enjoyed, and in due time, passed along to the next generation. Because you know that Browning's timeless blades are a cut above the rest.

KNIVES



SPEND SOME OVERTIME IN HELL'S CANYON.

Balance, heft and a smooth sweeping cut are what you can expect from the new Browning Overtime. Laminated G-10 scales offer just enough texture for a firm grip to transmit your precise movements to the high-carbon-steel blade as you cape out and skin game. And the new Hell's Canyon Speed makes quick work of any hellacious cutting chore. When it says Browning on the blade you know it's The Best There Is.

**NEW
2016**



A



B

*Made
in the
USA*

OVERTIME

TYPE Fixed blade **BLADE** D2 high carbon steel • Flat ground modified skinner blade **HANDLE** Full-tang construction • Color laminated G-10 scales • Decorative semi-flush fasteners **FEATURES** Anti-skid grooves on blade spine • Top grain leather belt sheath • Made in the USA

	MODEL	DESCRIPTION	OVERALL LENGTH	BLADE LENGTH	CODE NUMBER	SUGGESTED RETAIL
A	0220	Tan/Black Skinner	7-7/8	3-3/8	3220220	114.99
B	0221	Jade/Black Drop Point	7-7/8	3-3/8	3220221	

**NEW
2016**



**HELL'S
CANYON
SPEED**

HELL'S CANYON SPEED

TYPE Fixed blade **BLADE** ATS-34 stainless steel with carbon fiber insert • Modified drop point **HANDLE** Carbon fiber insert • Black rubber cord wrap on grip frame edge **FEATURES** Black fitted polymer belt sheath

MODEL	DESCRIPTION	OVERALL LENGTH	BLADE LENGTH	CODE NUMBER	SUGGESTED RETAIL
0105	Black/Black	8-3/4	3-1/2	3220105	79.99

EXPLORING THE ROAD TO DAMASCUS STEEL.

Like the stripes of a wild animal, the laminated bands of a genuine Damascus blade ripple and shimmer in the sunlight, giving true delight to the knowledgeable eye. Produced by hot-forging and folding layer upon layer of high-quality steel, each Damascus blade becomes a unique expression of the knifemaker's art.



NEW 2016

Made in the USA

STORM FRONT DAMASCUS

TYPE Fixed blade **BLADE** Hand-forged Damascus steel • Hollow ground blade on Stag models • Flat ground blade on Black Ash models **HANDLE** Stag or stabilized Black Ash hardwood
FEATURES Fine leather sheath • Made in the USA

NEW 2016	MODEL	DESCRIPTION	OVERALL LENGTH	BLADE LENGTH	CODE NUMBER	SUGGESTED RETAIL
A	0219	Stag Semi Skinner	8-1/2	4	3220219	
B	0218	Stag Clip Point	9	4-1/4	3220218	299.99
C	0217	Stag Drop Point	8-3/4	4-1/4	3220217	
D	218	Big Belly Skinner	7-5/8	3-1/2	322218	274.99
E	219	Drop Point	7-1/2	3-1/2	322219	



DAMASCUS FOLDERS

TYPE Folding blade **BLADE** Hollow ground Damascus steel **HANDLE** Full Damascus, Mother-of-Pearl or Mammoth Tooth **FEATURES** Damascus bolsters • Laser cut Buckmark in blade

MODEL	DESCRIPTION	OVERALL LENGTH	BLADE LENGTH	CODE NUMBER	SUGGESTED RETAIL
A	0240 Full Damascus	7-1/4	3-1/16	3220240	199.99
B	0241 Mother-of-Pearl	7-1/4	3-1/16	3220241	299.99
C	0242 Mammoth Tooth	7-1/4	3-1/16	3220242	499.99





RUSS KOMMER

It takes a serious knife user to design a serious knife. Russ Kommer has spent a lifetime hunting and guiding other hunters and draws from that experience every time he creates a new knife for Browning. Russ is one reason why Browning knives are The Best There Is. Read more about Russ on page 312.



ESCALADE

TYPE Fixed blade **BLADE** Mirror polished 9Cr stainless steel **HANDLE** Genuine jugged bone scales
 • Mirror polished stainless steel bolsters **FEATURES** Top-grain leather sheath

	MODEL	DESCRIPTION	OVERALL LENGTH	BLADE LENGTH	CODE NUMBER	SUGGESTED RETAIL
A	0131	Drop Point	7-1/4	3-1/4	3220131	109.99
B	0130	Skinner	6	2-1/2	3220130	79.99
C	0132	Bird and Trout	8-5/8	4-1/8	3220132	109.99



NEW 2016

NON-TYPICAL STAG

TYPE Fixed blade or folding blade **BLADE** Model 0228 has 7Cr stainless steel • Model 0226 has 8Cr18MoV stainless steel • Models 424 and 423 have 9Cr18MoV stainless steel
 • Model 227 has Sandvik 12C27 stainless steel **HANDLE** Genuine stag • Clip point model has a Grade IV walnut spacer pinned behind the guard **FEATURES** All models include a top grain leather sheath

	NEW 2016	MODEL	DESCRIPTION	OVERALL LENGTH	BLADE LENGTH	CODE NUMBER	SUGGESTED RETAIL
A	•	0228	Modified Drop Point	6-1/2	3	3220228	69.99
B		0227	Fixed Clip Point	7-3/4	3-1/2	3220227	149.99
C		0226	Folder	8	3-1/2	3220226	54.99
D		424	Fixed Skinning	7	2-7/8	322424	
E		423	Fixed Drop Point	7	2-7/8	322423	109.99



FEATHERWEIGHT

TYPE Fixed and folding **BLADE** Hollow ground, brushed finish AUS-8 stainless steel **HANDLE** Black Zytel® synthetic with contrasting tropical hardwood insert **FEATURES** Buckmark medallion on handle • All models except Small Folder and Multi-Blade have rugged Ballistic Cloth nylon belt sheaths

MODEL	DESCRIPTION	OVERALL LENGTH	BLADE LENGTH	CODE NUMBER	SUGGESTED RETAIL
A	928 Fixed Drop Point	8-1/4	3-5/8	322928	69.99
B	946 Fixed Semi-Skinner	8-1/8	3-3/8	322946	
C	929 Fixed Guthook	8-1/2	3-7/8	322929	79.99
D	908 Large Folder	7-3/4	3-3/8	322908	54.99
E	950 Small Folder	4-7/8	2-1/8	322950	44.99
F	918 Big Game	6-1/8	3-1/2	322918	89.99
G	972 Multi-Blade	5	2-1/4	322972	54.99



BUCKMARK ART

TYPE Folding liner lock **BLADE** Mo-V Molybdenum/Vanadium steel **HANDLE** Micarta with Mother-of-Pearl art inlay on Model 721 • G-10 with Abalone inlay on Model 719 **FEATURES** Pocket clip and thumb stud

MODEL	DESCRIPTION	OVERALL LENGTH	BLADE LENGTH	CODE NUMBER	SUGGESTED RETAIL
A	721 Large	7-1/8	3	322721	69.99
B	719 Small	5-1/4	2-1/4	322719	54.99



MODEL 111

TYPE Folding lockback **BLADE** Sandvik® 12C27 stainless steel **HANDLE** Canoe handle with finger grooves
 • Model 111C has Cocobolo hardwood scales and white brass bolsters • Model 111D has black G-10 scales and stainless steel bolsters **FEATURES** Nylon sheath included (not shown)

MODEL	DESCRIPTION	OVERALL LENGTH	BLADE LENGTH	CODE NUMBER	SUGGESTED RETAIL
A	111C Cocobolo	7-3/4	3-1/4	322111C	39.99
B	111D Black G-10	7-3/4	3-1/4	322111D	34.99

CLASSIC

TYPE Folding lockback **BLADE** Stainless steel drop point with laser engraving and gold-tone Buckmark in oval frame **HANDLE** Brushed stainless steel, dark sandalwood or genuine stag scales
 • Brushed stainless bolsters **FEATURES** Ultra-thin construction of the knife lets it slide easily into the pocket without adding excess bulk

MODEL	DESCRIPTION	OVERALL LENGTH	BLADE LENGTH	CODE NUMBER	SUGGESTED RETAIL
A	368 Stag	5-1/2	2-5/8	322368	34.99
B	367 Sandalwood	5-1/2	2-5/8	322367	24.99
C	366 Stainless	5-1/2	2-5/8	322366	



PURSUIT

TYPE Fixed blade and folding lockback **BLADE** 440 stainless steel **HANDLE** Highly figured burl wood, cocobolo, stag, sheep horn or black G-10 laminate • Double bolsters
FEATURES Nylon sheath on fixed blade models • Value priced

MODEL	DESCRIPTION	OVERALL LENGTH	BLADE LENGTH	CODE NUMBER	SUGGESTED RETAIL
A	508 Burl Wood Fixed	7-1/8	3-3/8	322508	29.99
B	0270 Cocobolo Fixed	7-1/8	3-3/8	3220270	
C	839 Stag Folder	6-1/2	2-3/4	322839	44.99
D	837 Sheep Horn Folder	6-1/2	2-3/4	322837	24.99
E	835 Burl Wood Folder	6-1/2	2-3/4	322835	19.99
F	832 Black G-10 Folder	6-1/2	2-3/4	322832	



HUNT 'N GUT

TYPE Folding liner lock **BLADES** Hollow ground, brushed finish 8Cr stainless steel • Main drop point blade has gut hook • Sheepfoot blade has double cutting bone saw **HANDLE** Hardwood or alloy with Mossy Oak® Break-Up Country® camo • Flush fasteners **FEATURES** Thumb stud

	MODEL	DESCRIPTION	OVERALL LENGTH	BLADE LENGTH	CODE NUMBER	SUGGESTED RETAIL
A	0053	Hardwood	8	3-1/2	3220053	34.99
B	0054	MOBUC	8	3-1/2	3220054	



STEEL SHARP WITH ERT (EDGE RETENTION TECHNOLOGY)



TYPE Fixed **BLADE** Hollow ground, brushed finish 7Cr stainless steel • Anti-skid grooves on blade spine **HANDLE** Black with contrasting handle inserts • Flush handle fasteners **FEATURES** Carbide sharpener module with magnetic retention easily removes from handle • Lanyard eyelet • Nylon sheath included (not shown)

	MODEL	DESCRIPTION	OVERALL LENGTH	BLADE LENGTH	CODE NUMBER	SUGGESTED RETAIL
A	0224	Fixed Skinner	8	3-3/8	3220224	39.99
B	0225	Fixed Drop Point	8	3-1/4	3220225	



Sharpener module fits into a recess in the knife's spine.



WOODS RUNNER

TYPE Fixed blade **BLADE** Hollow ground, brushed finish 8Cr13MoV stainless steel **HANDLE** Arizona Desert Ironwood hardwood scales • Contrasting carbon fiber insert • Stainless steel spacers • Mosaic handle pins **FEATURES** Brown top grain leather belt sheath

MODEL	DESCRIPTION	OVERALL LENGTH	BLADE LENGTH	CODE NUMBER	SUGGESTED RETAIL
617	Desert Ironwood	7-1/2	3-5/8	322617	59.99



STAG LIL' BIT

TYPE Folding lockback **BLADE** Sandvik® 12C27 stainless steel **HANDLE** Genuine stag • Stainless steel bolsters with rack and skull engraving **FEATURES** Braided leather lanyard

MODEL	OVERALL LENGTH	BLADE LENGTH	CODE NUMBER	SUGGESTED RETAIL
794	6-1/2	2-3/4	322794	54.99

Lil' Bit logo is engraved on the rear bolster.



COCOBOLO BIG GAME

TYPE Hidden tang fixed blade **BLADE** 440 stainless steel **HANDLE** Cocobolo hardwood with brass and bone accents **FEATURES** Includes a top grain leather sheath

MODEL	OVERALL LENGTH	BLADE LENGTH	CODE NUMBER	SUGGESTED RETAIL
529	8-1/2	3-3/4	322529	54.99



FULL CURL SHEEP

TYPE Folding lockback **BLADE** 440 stainless steel drop point
HANDLE Genuine sheep horn handle with brass pins
 • Solid nickel silver bolsters **FEATURES** Top grain leather belt sheath with snap flap included

MODEL	OVERALL LENGTH	BLADE LENGTH	CODE NUMBER	SUGGESTED RETAIL
107	6-5/8	2-5/8	322107	39.99

NEW 2016



HELL'S CANYON SKELETON

TYPE Fixed blade **BLADE** 7Cr stainless steel • Titanium coating **HANDLE** Full-tang construction
 • Decorative-cut G-10 handle scales • Flush fasteners • Lanyard eyelet **FEATURES** Combo set features both large and caping knives • Nylon sheath with molded insert

	MODEL	DESCRIPTION	OVERALL LENGTH	BLADE LENGTH	CODE NUMBER	SUGGESTED RETAIL
A	0247	Large Drop Point	8-1/4	3-1/4	3220247	39.99
B	0248	Combo Set	6-1/4	2-1/8	3220248	59.99



HELL'S CANYON AND HELL'S BELLES

TYPE Folding lockback **BLADE** 7Cr stainless steel **HANDLE** Stainless steel bolsters • Finger choils • MOINF and MO Pink models have aluminum scale inserts • Blaze model has G-10 scale inserts **FEATURES** Anti-skid grooves on blade spine

	MODEL	DESCRIPTION	OVERALL LENGTH	BLADE LENGTH	CODE NUMBER	SUGGESTED RETAIL
A	639	Mossy Oak Break-Up Infinity	7-1/4	3-1/8	322639	39.99
B	624	Blaze G-10	7-1/4	3-1/8	322624	29.99
C	765	Mossy Oak Pink	7-1/4	3-1/8	322765	39.99



BROWNING FOR HER

TYPE Folding locking liner **BLADE** Swedish Sandvik® 12C27 stainless steel
HANDLE Aluminum with pink and camo Dura-Touch Armor Coating
 • Anodized aluminum bolsters **FEATURES** Rugged nylon sheath and pocket clip

MODEL	OVERALL LENGTH	BLADE LENGTH	CODE NUMBER	SUGGESTED RETAIL
894	6-3/8	2-3/4	322894	29.99



PRISM II

TYPE Folding liner lock **BLADE** 440-A stainless steel **HANDLE** Color anodized machined aluminum, MOINF, carbon fiber print or zebra safari print scales
FEATURES Pocket clip
 • Matte aluminum bolster with Buckmark logo
 • Thumb stud

	MODEL	DESCRIPTION	OVERALL LENGTH	BLADE LENGTH	CODE NUMBER	SUGGESTED RETAIL
A	5662	Black	5-5/8	2-1/2	3225662	14.99
B	5622	Pink	5-5/8	2-1/2	3225622	
C	5632	Orange	5-5/8	2-1/2	3225632	
D	5672	Mossy Oak Break-Up Infinity	5-5/8	2-1/2	3225672	
E	776	Zebra	6-1/4	2-3/4	322776	
F	5692	Crimson	5-5/8	2-1/2	3225692	
G	5682	Violet	5-5/8	2-1/2	3225682	
H	5612	Aqua	5-5/8	2-1/2	3225612	
I	779	Carbon Fiber	5-5/8	2-1/2	322779	



BUCKMARK MONEY CLIP

TYPE Folding blade and screwdriver **BLADE** Stainless steel **HANDLE** Anodized aluminum
FEATURES Ultra-thin construction • Flush fasteners • Metal money clip • Screwdriver has adjustment tool for coin-slotted rifle scope knobs

	MODEL	DESCRIPTION	OVERALL LENGTH	BLADE LENGTH	CODE NUMBER	SUGGESTED RETAIL
A	0122	Silver	2	1-3/8	3220122	15.99
B	0123	Black	2	1-3/8	3220123	
C	0124	MOBU	2	1-3/8	3220124	



MINNOW

TYPE Folding blade **BLADE** 7Cr stainless steel **HANDLE** Anodized two-tone aluminum
FEATURES Lanyard eye • Thumb stud • Laser-cut Buckmark in blade • Ultra-thin construction lets the knife slide easily into the pocket without adding excess bulk

	MODEL	DESCRIPTION	OVERALL LENGTH	BLADE LENGTH	CODE NUMBER	SUGGESTED RETAIL
A	0060	Slate/Black	4-3/4	1-7/8	3220060	14.99
B	0061	Neon Green/Black	4-3/4	1-7/8	3220061	
C	0062	Neon Orange/Black	4-3/4	1-7/8	3220062	
D	0063	Neon Pink/Black	4-3/4	1-7/8	3220063	

**INCENTIVE**

TYPE Folding lockback **BLADE** 7Cr stainless steel drop point **HANDLE** Genuine cocobolo or black G-10 handle with flush finished stainless pins • Solid brushed stainless bolsters **FEATURES** Nylon belt sheath included

MODEL	DESCRIPTION	OVERALL LENGTH	BLADE LENGTH	CODE NUMBER	SUGGESTED RETAIL
A	0245 Cocobolo	8-1/2	3-1/2	3220245	39.99
B	0246 Black G-10	8-1/2	3-1/2	3220246	

**IGNITE**

TYPE Fixed blade **BLADE** 7Cr stainless steel • Titanium blade coating on gray model • Black oxide blade coating on orange model • Sparking bevel on spine **HANDLE** Polymer with molded contrasting grip inserts and lanyard eyelet **FEATURES** Rugged polymer sheath • Fire starting flint with polymer handle inserts into sheath

MODEL	DESCRIPTION	OVERALL LENGTH	BLADE LENGTH	CODE NUMBER	SUGGESTED RETAIL
A	0160 Black and Gray	8-1/2	4	3220160	29.99
B	0161 Black and Orange	8-1/2	4	3220161	

**CAYMAN**

TYPE Folding blade **BLADE** 7Cr stainless steel **HANDLE** Double injection molded • Anodized aluminum bolsters **FEATURES** Pocket clip

MODEL	DESCRIPTION	OVERALL LENGTH	BLADE LENGTH	CODE NUMBER	SUGGESTED RETAIL
A	0035 Black and Gray	7-3/4	3-3/8	3220035	19.99
B	0036 Black and Tan	7-3/4	3-3/8	3220036	

**MOUNTAIN TI**

TYPE Folding frame lock **BLADE** 440-A stainless steel drop point • Titanium coated for added corrosion resistance **HANDLE** Machined 420J1 stainless steel with two-tone gray finish • Laser cut Buckmark logo • Titanium coated **FEATURES** Pocket clip • Ambidextrous thumb stud • Lanyard eyelet

MODEL	DESCRIPTION	OVERALL LENGTH	BLADE LENGTH	CODE NUMBER	SUGGESTED RETAIL
A	561 Small	5	2-1/4	322561	19.99
B	560 Medium	6-3/8	3	322560	24.99

**VORTEX**

TYPE Fixed blade and folding liner locks **BLADE** 440 stainless steel with titanium coating • Anti-skid grooves on blade spine • Ambidextrous thumb studs on folders **HANDLE** Black G-10 scales • Carbon fiber bolsters • Finger groove handle design **FEATURES** Nylon sheath on fixed blade model • Buckmark pocket clip on folders

MODEL	DESCRIPTION	OVERALL LENGTH	BLADE LENGTH	CODE NUMBER	SUGGESTED RETAIL
A	7532 Fixed Blade	8-7/8	3-3/4	3227532	59.99
B	7530 Drop Point	8	3-3/8	3227530	
C	7531 Bird & Trout	7-3/4	3-3/8	3227531	29.99



Unique laser cut Buckmark pocket clip.



HOG HUNTER

TYPE Fixed blade **BLADE** 7" hollow ground 440 stainless steel • Laser-engraved Hog Hunter logo **HANDLE** Molded synthetic rubber with checkered surface for improved grip **FEATURES** Includes black nylon sheath

MODEL	OVERALL LENGTH	BLADE LENGTH	CODE NUMBER	SUGGESTED RETAIL
865	12	7	322865	49.99



CROWELL/BARKER COMPETITION

TYPE Fixed blade competition **BLADE** Heavy drop point made from high-carbon steel with a .142 satin finish • Designed by World Cutting Champions James Crowell and Reggie Barker • Laser-etched on one side with Browning logo **HANDLE** Resin-laminated canvas scales with three rivets and wrist lanyard **FEATURES** Custom-made top-grain leather belt sheath • Certificate of Authenticity signed by Crowell and Barker • Approved for select International Cutting Competition Trail (ICCT) events

MODEL	OVERALL LENGTH	BLADE LENGTH	CODE NUMBER	SUGGESTED RETAIL
580	15	10	322580	164.99

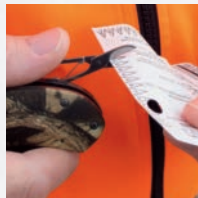

TAGGED OUT

TYPE Folding liner lock **BLADE** 8Cr13MoV stainless steel **HANDLE** Aircraft-grade aluminum with Mossy Oak® Break-Up Infinity® camo • Dura-Touch Armor Coating **FEATURES** Pocket clip • Folding scissors

MODEL	OVERALL LENGTH	BLADE LENGTH	CODE NUMBER	SUGGESTED RETAIL
207	8-1/4	3-1/2	322207	39.99



DIRTY BIRD AND TROUT

TYPE Fixed blade or folder **BLADE** 440 stainless steel with titanium coating • Unique blade shape • Perfect for intricate cuts in tight places like wing joints **HANDLE** Aluminum alloy with Mossy Oak® Duck Blind® camo • Titanium coated bolster • Oval-shaped lanyard eye **FEATURES** Nylon sheath

	MODEL	DESCRIPTION	OVERALL LENGTH	BLADE LENGTH	CODE NUMBER	SUGGESTED RETAIL
A	350	Fixed	8-3/8	3-1/2	322350	29.99
B	339	Folder	8-1/2	3-1/2	322339	



OUTDOORSMAN CAMP KNIFE

TYPE Fixed blade **BLADE** 8Cr brushed stainless steel • Anti-skid grooves on blade spine **HANDLE** Black and tan sculpted G-10 laminate • Tapered full-tang • Flush fasteners **FEATURES** Lanyard eyelet • Nylon sheath

MODEL	OVERALL LENGTH	BLADE LENGTH	CODE NUMBER	SUGGESTED RETAIL
0195	11-1/2	6-1/4	3220195	79.99





Each tool has its own pocket in the durable roll-up nylon case, making storage and transport a breeze.

D.I.Y. BUTCHER KIT

TYPE Multiple tool field butcher's kit **BLADES** 420 stainless steel • **Brushed satin finish** with Browning logo **HANDLE** Durable injection molded synthetic rubber handles offer ribbed texture ridges for a sure grip **FEATURES** Includes a 7-1/2" fillet knife, 6-1/2" butcher knife, 5-1/2" boning knife (also available separately), 4" skinning knife and a 3-1/2" folding lockback drop point knife • Full size sharpening steel, 3-1/2" game shears and a Night Seeker LED cap light • Three larger knives have detachable hard polymer protective sheaths • Two smaller knives have durable nylon belt sheaths • Black nylon compartmented tool roll is included

MODEL	DESCRIPTION	OVERALL LENGTH	BLADE LENGTH	CODE NUMBER	SUGGESTED RETAIL
A 100	Butcher Kit	—	—	322100	99.99
B 116	D.I.Y. Boning Knife	7-1/2	3-5/8	322116	19.99



NEW 2016



WHITE WATER FILLET

TYPE Fixed blade **BLADE** 420 J2 bright stainless steel **HANDLE** Washable injection molded polymer with contrasting soft textured grip inserts • Nylon lanyard **FEATURES** Hard polymer protective sheath with Buckmark cut-out

	NEW 2016	MODEL	DESCRIPTION	OVERALL LENGTH	BLADE LENGTH	CODE NUMBER	SUGGESTED RETAIL
A	•	0101	White	14-1/4	9-1/4	3220101	19.99
B		0100	Yellow	12-1/2	7-1/4	3220100	17.99

**NEW
2016**



INCASE

TYPE Fixed drop point blade **BLADE** 440 stainless steel **HANDLE** Full-tang construction • Sculpted G-10 scales • Leather fob **FEATURES** Integrated horizontal pivoting sheath • Patented Reliant retention control trigger • Ammo belt case with magnetic flap closure holds six rounds

	MODEL	DESCRIPTION	OVERALL LENGTH	BLADE LENGTH	CODE NUMBER	SUGGESTED RETAIL
A	0235	Leather	7-1/2	3-1/4	3220235	89.99
B	0236	Nylon	7-1/2	3-1/4	3220236	79.99



KNIFE SHARPENER

TYPE Sharpener **BLADE** Two carbide steel sharpening inserts **HANDLE** Anodized alloy Buckmark **FEATURES** Quickly sharpens most blades • Ideal for pocket, pack, kitchen, cabin or camp • Includes split key ring

MODEL	OVERALL LENGTH	CODE NUMBER	SUGGESTED RETAIL
0010	3-3/16	3220010	7.99



T-Handle Saw comes with a durable nylon belt sheath.

GAME REAPER SAW

TYPE T-handle pelvic saw and guthook **BLADE** 440-C stainless **HANDLE** Contour molded composite • T-shaped handle • Machined grooves for a sure grip with better control **FEATURES** Durable black nylon belt sheath with hook and loop flap closure

MODEL	OVERALL LENGTH	BLADE LENGTH	CODE NUMBER	SUGGESTED RETAIL
926	5-7/8	3-3/4	322926	24.99



CAMP SAW

TYPE Folding camp saw **BLADE** 4116 stainless steel with push/pull saw teeth **HANDLE** Injection molded composite with rubber gripping inlays • Finger grooves and large tail radius for greater comfort and control **FEATURES** Button securely locks the blade in both the open and closed position • Included nylon sheath can be worn in vertical or horizontal position (not shown)

MODEL	BLADE LENGTH	CODE NUMBER	SUGGESTED RETAIL
922	5-1/8	322922	24.99

**OUTDOORSMAN ULU HATCHET**

TYPE Ulu-style hatchet **BLADE** One-piece head of hollow-ground 4Cr steel • Black oxide finish • Inspired by the traditional Eskimo ulu, the skeletonized curved blade can be used to chop, carve and skin game **HANDLE** Integrated full-tang construction with braided camo paracord wrap **FEATURES** Lanyard eyelet • Nylon sheath included

MODEL	CODE NUMBER	SUGGESTED RETAIL
0045	3220045	34.99



OUTDOORSMAN



Includes tough nylon sheath with snap closure.

OUTDOORSMAN AXE

TYPE Axe **BLADE** One-piece head is hot-forged, hollow ground, high carbon 1055 tool steel **HANDLE** Reinforced polymer **FEATURES** Handle is shaped for easy hand placement when cutting kindling • Sheath included

MODEL	CODE NUMBER	SUGGESTED RETAIL
231	322231	69.99



OUTDOORSMAN

**OUTDOORSMAN SHEARS**

TYPE Shears **BLADE** High carbon tool steel **HANDLES** Tough polypropylene and rubber • Telescopes from 21" to 28" **FEATURES** Lower blade is serrated on one edge • Large guthook • Sheath included

MODEL	CODE NUMBER	SUGGESTED RETAIL
230	322230	54.99



OUTDOORSMAN



Includes tough nylon sheath with snap closure.

**OUTDOORSMAN SHOVEL**

TYPE Folding shovel **BLADE** 8-5/8" High carbon tool steel **HANDLE** Tough 22-1/2" tubular metal handle with D-shaped grip **FEATURES** Nylon pouch included (not shown)

MODEL	CODE NUMBER	SUGGESTED RETAIL
919	322919	39.99



OUTDOORSMAN

BIG, HARD CORE BLADES FOR TOUGH MISSIONS.

When the going gets tough grab a Black Label Tactical Blade. These hefty, no-nonsense knives are capable of rugged work and can cut their way out of any trouble. When you pick Black Label you're carrying a proven tactical blade that you can depend on for any mission and in any environment.

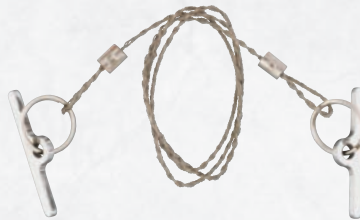

T-handled diamond wire survival saw stows in a concealed cavity inside the handle.

BLACK LABEL STOW-AWAY SURVIVAL

TYPE Fixed compound curve with false edge **BLADE** Hollow ground 440C stainless steel • Matte black finish for smoother cutting and added corrosion resistance • Splitting edge on spine **HANDLE** Full-tang construction • Deeply sculpted black and tan G-10 scales • Coin-slotted screws provide access to concealed cavity containing a T-handled diamond wire survival saw and knife sharpener **SHEATH** Nylon with built-in lanyard hole • Made in Italy

MODEL	OVERALL LENGTH	BLADE LENGTH	CODE NUMBER	SUGGESTED RETAIL
169BL	13-3/4	8-3/8	320169BL	239.99



Integrated wire cutter to cut a variety of wire diameters.

BLACK LABEL TRIP WIRE

TYPE Highly-modified spear point **BLADE** N690Co stainless steel • False edge and chopping grind on spine • Partially serrated edge • Black oxide finish **HANDLE** Ribbed G-10 grip scales • Built-in 3-position wire cutting system **SHEATH** Nylon with MOLLE compatible straps that attach to web gear or belt • Made in Italy

MODEL	OVERALL LENGTH	BLADE LENGTH	CODE NUMBER	SUGGESTED RETAIL
140BL	11-5/8	6	320140BL	274.99



BLACK LABEL COMMITTED

TYPE Fixed deep belly drop point **BLADE** Hollow ground 8Cr13MoV stainless steel • Partially serrated edge **HANDLE** Full-tang construction • Textured olive drab G-10 scales • Lanyard hole **SHEATH** Blade-Tech™ molded polymer with Tek-Lok™ belt clip easily adjusts for carry angle and belt loop width

MODEL	OVERALL LENGTH	BLADE LENGTH	CODE NUMBER	SUGGESTED RETAIL
163BL	10-1/4	5-3/8	320163BL	79.99



BLACK LABEL BATTLE BOWIE G-10

TYPE Fixed bowie **BLADE** Hollow ground 5Cr stainless steel **HANDLE** Full-tang construction • Black G-10 scales **SHEATH** Blade-Tech™ molded polymer with Tek-Lok™ belt clip easily adjusts for carry angle and belt loop width

MODEL	OVERALL LENGTH	BLADE LENGTH	CODE NUMBER	SUGGESTED RETAIL
160BL	12-1/2	8	320160BL	89.99



JARED WIHONGI

Among the world's foremost law enforcement instructors in edged weapons, Jared Wihongi makes no compromises in his training or his gear. With his experience, Jared is instrumental in the development of every Browning Black Label Tactical Blade we produce. Read more about Jared on page 310.



**BLACK LABEL SHADOWFAX**

TYPE Fixed modified drop point with false edge **BLADE** Hollow ground satin finish AUS8 stainless steel **HANDLE** Full-tang construction • Brown G-10 scales **SHEATH** Blade-Tech™ molded polymer with Tek-Lok™ belt clip easily adjusts for carry angle and belt loop width • Patented Reliant retention control trigger

MODEL	OVERALL LENGTH	BLADE LENGTH	CODE NUMBER	SUGGESTED RETAIL
190BL	9	4-5/8	320190BL	129.99

**BLACK LABEL ARBITRATOR**

TYPE Fixed false edge tactical **BLADE** Hollow ground satin finish 154CM stainless steel **HANDLE** Full-tang construction • Black G-10 scales **SHEATH** Blade-Tech™ molded polymer with Tek-Lok™ belt clip easily adjusts for carry angle and belt loop width • Made in the USA

MODEL	OVERALL LENGTH	BLADE LENGTH	CODE NUMBER	SUGGESTED RETAIL
103BL	10-3/4	5-1/2	320103BL	189.99

**BLACK LABEL POINT BLANK**

TYPE Fixed clip point **BLADE** 440 stainless steel • Black oxide finish on black handle model **HANDLE** Hidden tang construction • Black G-10 handle **SHEATH** Blade-Tech™ molded polymer with Tek-Lok™ belt clip easily adjusts for carry angle and belt loop width

MODEL	OVERALL LENGTH	BLADE LENGTH	CODE NUMBER	SUGGESTED RETAIL
111BL	10-3/8	6	320111BL	69.99

**BLACK LABEL STICK-IT THROWING KNIFE SET**

TYPE Fixed double edged throwing daggers **BLADES** Hollow ground, satin-finished 3Cr stainless steel **HANDLES** Full-tang **SHEATH** Nylon

MODEL	OVERALL LENGTH	BLADE LENGTH	CODE NUMBER	SUGGESTED RETAIL
122BL	8-1/2	4	320122BL	44.99

**BLACK LABEL BACKLASH**

TYPE Fixed double edged **BLADE** Hollow ground 5Cr15MoV stainless steel • Titanium finish **HANDLE** CNC machined black G-10 • Stainless steel pommel and handguard • Titanium finish **SHEATH** Blade-Tech™ molded polymer with Tek-Lok™ belt clip easily adjusts for carry angle and belt loop width

MODEL	OVERALL LENGTH	BLADE LENGTH	CODE NUMBER	SUGGESTED RETAIL
145BL	10	5-1/2	320145BL	59.99

**BLACK LABEL RAIL SYSTEM**

TYPE Fixed double edged **BLADE** Hollow ground 5Cr15MoV stainless steel **HANDLE** Anodized aluminum **SHEATH** Blade-Tech™ molded polymer sheath attaches to any MIL-STD 1913 accessory rail • This patented design by Kelly Van Orden of Battle Blades adds a whole new dimension to the tactical firearm/knife platform (MIL-STD 1913 rail section as shown is not included)

MODEL	OVERALL LENGTH	BLADE LENGTH	CODE NUMBER	SUGGESTED RETAIL
150BL	10	5-1/2	320150BL	79.99



Made in the USA

BLACK LABEL BOOT DAGGER

TYPE Fixed double edged dagger **BLADE** Hollow ground satin finish 154CM stainless steel **HANDLE** Full-tang construction
 • Black G-10 scales **SHEATH** Blade-Tech™ molded polymer with Tek-Lok™ belt clip easily adjusts for carry angle and belt loop width • Made in the USA

MODEL	OVERALL LENGTH	BLADE LENGTH	CODE NUMBER	SUGGESTED RETAIL
102BL	8-1/2	3-15/16	320102BL	189.99



Made in the USA

BLACK LABEL VOLATILE

TYPE Fixed double edged push dagger **BLADE** Hollow ground satin finish 154CM stainless steel **HANDLE** Full-tang construction
 • Black G-10 scales **SHEATH** Blade-Tech™ molded polymer with Tek-Lok™ belt clip easily adjusts for carry angle and belt loop width • Made in the USA

MODEL	OVERALL LENGTH	BLADE LENGTH	CODE NUMBER	SUGGESTED RETAIL
108BL	5-9/16	4	320108BL	164.99

NEW 2016



BLACK LABEL LADY LUCK

TYPE Fixed double edged push dagger **BLADE** Hollow ground satin finish 7Cr stainless steel **HANDLE** Full-tang construction
 • Black G-10 scales **SHEATH** Injection molded polymer sheath

MODEL	OVERALL LENGTH	BLADE LENGTH	CODE NUMBER	SUGGESTED RETAIL
187BL	5-1/2	2-1/2	320187BL	29.99



NEW 2016



BLACK LABEL STACKED DECK

TYPE Folding frame lock **BLADE** VG10 stainless steel • Modified spear point or tactical wharncliffe **HANDLE** Machined and sculpted matte titanium **FEATURES** Flipper assisted opening • Ambidextrous thumb stud • Ball-bearing blade pivot • Pocket clip • Lanyard eyelet

MODEL	DESCRIPTION	OVERALL LENGTH	BLADE LENGTH	CODE NUMBER	SUGGESTED RETAIL
A	Tactical	8	3-1/2	320189BL	179.99
B	Spear Point	8	3-1/2	320191BL	



BLACK LABEL PANDEMONIUM FIXED BLADE

TYPE Fixed unique modified tanto **BLADE** Bead blasted 440 stainless steel **HANDLE** Full-tang construction • Black G-10 scales **SHEATH** Blade-Tech™ molded polymer with Tek-Lok™ belt clip easily adjusts for carry angle and belt loop width

MODEL	OVERALL LENGTH	BLADE LENGTH	CODE NUMBER	SUGGESTED RETAIL
126BL	8-5/8	4-1/4	320126BL	54.99



BLACK LABEL PANDEMONIUM FOLDER

TYPE Folding unique modified tanto **BLADE** Hollow ground 440 stainless steel • Black oxide finish • Thumb stud **HANDLE** Textured black G-10 scales • Four-way adjustable tactical pocket clip

MODEL	OVERALL LENGTH	BLADE LENGTH	CODE NUMBER	SUGGESTED RETAIL
124BL	7-3/4	3-1/2	320124BL	29.99

NEW 2016



Made in the USA

BLACK LABEL PANDEMONIUM ASSISTED OPENING AND FULL AUTO*

TYPE Folding unique modified tanto **BLADE** Hollow ground 440 stainless steel • Black oxide finish • Thumb stud **HANDLE** Checkered black G-10 scales • Tactical pocket clip • Assisted opening design • Made in the USA

MODEL	OVERALL LENGTH	BLADE LENGTH	CODE NUMBER	SUGGESTED RETAIL
177BL	7-3/4	3-1/2	320177BL	309.99
178BL*	7-3/4	3-1/2	320178BL	

*Due to local laws and regulations on full auto knives, this model may not be available in your area. See your local Browning retailer for more information.

NEW 2016



BLACK LABEL 1911 FOLDER

TYPE Folding spear point **BLADE** Hollow ground 8Cr stainless steel • Blood groove • Ambidextrous thumb stud **HANDLE** Shape inspired by the 1911 pistol grip • Machined G-10 scales • Pocket clip **FEATURES** Kicker assisted opening design

MODEL	OVERALL LENGTH	BLADE LENGTH	CODE NUMBER	SUGGESTED RETAIL
181BL	6-1/2	2-7/8	320181BL	39.99

NEW 2016



Made in the USA

BLACK LABEL STEEL DUTY ASSISTED OPENING

TYPE Folding spear point **BLADE** Hollow ground, stainless steel **HANDLE** Robust liner lock construction • Aggressively textured black G-10 scales • Pocket clip **FEATURES** Spring assisted opening design • Made in the USA

MODEL	OVERALL LENGTH	BLADE LENGTH	CODE NUMBER	SUGGESTED RETAIL
179BL	7-1/2	3	320179BL	329.99

NEW 2016



BLACK LABEL UNLEASHED ASSISTED OPENING

TYPE Folding modified drop point **BLADE** Hollow ground stainless steel • Blood groove **HANDLE** Robust liner lock construction • Aggressively textured G-10 scales • Pocket clip with Black Label shield **FEATURES** Spring assisted opening design

MODEL	OVERALL LENGTH	BLADE LENGTH	CODE NUMBER	SUGGESTED RETAIL
175BL	7-3/4	3-1/4	320175BL	29.99

NEW 2016



BLACK LABEL VANQUISH POCKET DEPLOY

TYPE Folding spear point **BLADE** Color matched stainless steel **HANDLE** Liner lock construction • Index finger ring and folding thumb ramp • Black or tan sculpted G-10 scales • Tactical 2-position pocket clip **FEATURES** Assisted opening design • Thumb stud • Features the patented SNAG System by KRUDO Knives • Safe edge/point training model also available

MODEL	DESCRIPTION	OVERALL LENGTH	BLADE LENGTH	CODE NUMBER	SUGGESTED RETAIL
A 176BL	Black	7-1/2	2-3/4	320176BL	44.99
B 182BL	Tan	7-1/2	2-3/4	320182BL	
C 176BLT	Blue Trainer	7-1/2	2-3/4	320176BLT	44.00



NEW 2016



BLACK LABEL SPEED DIAL POCKET DEPLOY

TYPE Folding deep belly tanto point **BLADE** Color matched stainless steel **HANDLE** Liner lock construction • Index finger ring and folding thumb ramp • Machined G-10 scales • 2-position pocket clip **FEATURES** Assisted opening design • Thumb stud **FEATURES** Patented SNAG System by KRUDO Knives

MODEL	OVERALL LENGTH	BLADE LENGTH	CODE NUMBER	SUGGESTED RETAIL
188BL	9-1/8	3-5/8	320188BL	44.99

NEW 2016



BLACK LABEL DURATION

TYPE Folding spear point **BLADE** Hollow ground, partially serrated stainless steel **HANDLE** Robust liner lock construction • Machined G-10 scales • Four-way adjustable tactical pocket clip **FEATURES** Protected seat belt cutter • Hardened glass breaking point

MODEL	DESCRIPTION	OVERALL LENGTH	BLADE LENGTH	CODE NUMBER	SUGGESTED RETAIL
A	173BL Black	7-3/4	3-1/4	320173BL	29.99
B	174BL Green	7-3/4	3-1/4	320174BL	

NEW 2016



BLACK LABEL THIN ICE

TYPE Folding liner lock **BLADE** Titanium coated 8Cr13MoV stainless steel slimline tanto **HANDLE** Black or tan G-10 scales • Flush fasteners **FEATURES** Ambidextrous thumb stud • Carbon fiber bolsters • Pocket clip

MODEL	DESCRIPTION	OVERALL LENGTH	BLADE LENGTH	CODE NUMBER	SUGGESTED RETAIL
A	185BL Black	7-1/8	3-1/8	320185BL	29.99
B	186BL Tan	7-1/8	3-1/8	320186BL	



BLACK LABEL NO BOUNDARIES

TYPE Folding modified drop point **BLADE** Hollow ground 8Cr13MoV stainless steel • Blood groove • Titanium finish • Ambidextrous thumb stud **HANDLE** Robust liner lock construction • Sculpted G-10 scales • 3-way tactical pocket clip • Color matched titanium finish • Flipper

MODEL	DESCRIPTION	OVERALL LENGTH	BLADE LENGTH	CODE NUMBER	SUGGESTED RETAIL
A	168BL Black	8	3-3/4	320168BL	34.99
B	167BL Tan	8	3-3/4	320167BL	



Made in the USA

BLACK LABEL PERFECT STORM

TYPE Folding tanto **BLADE** Hollow ground black oxide coated 154CM stainless steel **HANDLE** Robust liner lock construction • Black G-10 scales • Four-way adjustable tactical pocket clip • Made in the USA

MODEL	OVERALL LENGTH	BLADE LENGTH	CODE NUMBER	SUGGESTED RETAIL
105BL	9-9/16	3-7/8	320105BL	199.99



Made
in the
USA

BLACK LABEL HELL FIRE

TYPE Folding tanto **BLADE** Hollow ground black oxide coated 154CM stainless steel with flipper **HANDLE** Robust liner lock construction • Black G-10 scales • Four-way adjustable tactical pocket clip • Made in the USA

MODEL	OVERALL LENGTH	BLADE LENGTH	CODE NUMBER	SUGGESTED RETAIL
100BL	8-1/16	3-9/16	320100BL	199.99



BLACK LABEL STONE COLD

TYPE Folding spear point or tanto **BLADE** Hollow ground 440 stainless steel • Black oxide finish • Thumb stud **HANDLE** Robust liner lock construction • Textured and checkered black G-10 scales • Four-way adjustable tactical pocket clip **FEATURES** Hardened glass breaking point and flipper

MODEL	DESCRIPTION	OVERALL LENGTH	BLADE LENGTH	CODE NUMBER	SUGGESTED RETAIL
A	113BL Tanto	8-5/8	3-3/4	320113BL	34.99
B	114BL Spear Point	8-5/8	3-3/4	320114BL	



BLACK LABEL INTEGRITY

TYPE Folding tanto **BLADE** Hollow ground 440 stainless steel • Titanium finish • Thumb stud **HANDLE** Robust liner lock construction • Textured black G-10 scales • Four-way adjustable tactical pocket clip

MODEL	OVERALL LENGTH	BLADE LENGTH	CODE NUMBER	SUGGESTED RETAIL
123BL	8-1/2	3-3/4	320123BL	29.99



Made
in the
USA

BLACK LABEL UNDISPUTED

TYPE Folding deep belly **BLADE** Hollow ground 154CM stainless steel **HANDLE** Robust liner lock construction • Black G-10 scales • Four-way adjustable tactical pocket clip • Made in the USA

MODEL	OVERALL LENGTH	BLADE LENGTH	CODE NUMBER	SUGGESTED RETAIL
107BL	7-3/4	3-1/8	320107BL	189.99



BLACK LABEL ASSOCIATE

TYPE Folding spear point **BLADE** Hollow ground 8Cr13MoV stainless steel **HANDLE** Unique George Sessions' patented frame lock construction • Carbon fiber scales • Tactical pocket clip

MODEL	OVERALL LENGTH	BLADE LENGTH	CODE NUMBER	SUGGESTED RETAIL
164BL	6-7/8	2-7/8	320164BL	29.99



BLACK LABEL CHECKMATE

TYPE Folding false edge spear point **BLADE** Hollow ground 8Cr13MoV stainless steel • Titanium finish • Thumb stud **HANDLE** Robust liner lock construction • Checkered G-10 scales • Tactical pocket clip • Titanium finish on bolsters and pocket clip **FEATURES** Hardened glass breaking point

MODEL	DESCRIPTION	OVERALL LENGTH	BLADE LENGTH	CODE NUMBER	SUGGESTED RETAIL
A	143BL Black	8-1/4	3-1/2	320143BL	39.99
B	144BL Coyote Tan	8-1/4	3-1/2	320144BL	



BLACK LABEL MONEY CLIP

TYPE Folding blade and screwdriver **BLADE** Stainless steel
HANDLE Checkered black G-10 scales with engraved Black Label shield **FEATURES** Ultra-thin construction • Flush fasteners • Metal money clip • Screwdriver has adjustment tool for coin-slotted rifle scope knobs

MODEL	OVERALL LENGTH	BLADE LENGTH	CODE NUMBER	SUGGESTED RETAIL
184BL	2	1-3/8	320184BL	13.99



BLACK LABEL TNT

TYPE Folding blade **BLADE** 440A stainless steel **HANDLE** Black or tan G-10 **FEATURES** Lanyard eyelet • Flush fasteners • Thumb window opening in blade • Ultra-thin construction of the knife lets it slide easily into the pocket without adding excess bulk

	MODEL	DESCRIPTION	OVERALL LENGTH	BLADE LENGTH	CODE NUMBER	SUGGESTED RETAIL
A	171BL	Black	4-5/8	1-5/8	320171BL	17.99
B	172BL	Tan	4-5/8	1-5/8	320172BL	



Polymer belt sheath included with the Shock 'N Awesome has thumb operated safety bail for secure carry.

BLACK LABEL SHOCK 'N AWESOME

TYPE Tactical tomahawk **BLADE** Hot forged, black powder coated 1055 tool steel • Curved penetration spike **HANDLE** One-piece with spiked pommel • Checkered G-10 scales • Lanyard hole **SHEATH** Blade-Tech™ molded polymer with MOLLE compatible attachment system that easily adjusts for carry angle

MODEL	OVERALL LENGTH	BLADE LENGTH	CODE NUMBER	SUGGESTED RETAIL
170BL	13	2-5/8	320170BL	119.99



Polymer belt sheath included with the Shock 'N Awe has thumb operated safety bail for secure carry.

BLACK LABEL SHOCK 'N AWE

TYPE Tactical tomahawk **BLADE** Hot forged, black powder coated 1055 tool steel • Curved penetration spike **HANDLE** One-piece with spiked pommel • Hand-wrapped black nylon paracord • Lanyard hole **SHEATH** Blade-Tech™ molded polymer with MOLLE compatible attachment system that easily adjusts for carry angle

MODEL	OVERALL LENGTH	BLADE LENGTH	CODE NUMBER	SUGGESTED RETAIL
110BL	10-1/2	2-3/4	320110BL	89.99



**BRILLIANT IDEAS
FROM BROWNING.**

The old hunter's adage "You can't hit what you can't see" also applies to any type of outdoor task that takes place in the gloom of night. From changing a flat tire on a lonely roadside to finding that downed buck just as evening closes in, having a reliable light is often the difference between your hunt being a great success or a total failure, or between having a memorable outing or a truly miserable experience.

Make sure that you have reliable, powerful and affordable Browning flashlights and headlamps readily at hand. A Browning light should be part of your everyday carry (EDC) gear and be standard equipment in your backpack, glove box or purse.

LIGHTS



HOW TO PICK THE RIGHT BROWNING LIGHT

Browning leads the industry in portable battery-powered lighting for hunters and shooters with more than 40 styles in our product line. Here are some bright ideas on picking the best light for your needs.

SIZE, WEIGHT AND POWER

When choosing a light, smaller, brighter and lighter are better. Today's high-output LEDs are so powerful and efficient they achieve the same light output as the old multi-cell C and D lights. The super bright Alpha and Alpha Max flashlights use a single AA battery yet are not much bigger than a shotgun shell.

LED VS. XENON BULBS

LEDs are preferred over Xenon bulbs for most uses, thus all our lights are now LED designs. LEDs use batteries more efficiently, illuminate at greater distances, emit a clean, even beam and will never burn out under normal use. Like most technology, LEDs keep getting better every year. For 2016 many of our lights offer upgraded LEDs with 15% - 300% more output.

HAND-HELD OR HANDS-FREE

Headlamps and cap lights allow the use of both hands for tasks like dressing a deer, fixing a truck or finding a path through the woods. Modern technology makes many headlamps as powerful as larger hand-held flashlights. The MicroBlast headlamp can be worn either as a headlamp, clipped to a shirt pocket or to the brim of a hat.

LONG RUN TIME

By using advanced digital circuitry, highly efficient LEDs and low-resistance switches, we are able to offer extra long run times on many lights. Most Tactical Hunter lights will run for 20-48 hours on the low setting. The High Noon 4C spotlight will run for 4 days at the low setting. These extended run times could be the difference between getting home safely and spending a night in the woods.

WATERPROOF AND SUBMERSIBLE

Because the great outdoors doesn't always have great weather, we have redesigned most flashlights to be waterproof and submersible to 3 feet for 30 minutes (ANSI IPX7). Most of our other lights are O-ring sealed for greater water resistance (IPX4). The High Noon LED spotlight is submersible and it floats.

BATTERIES

Lithium batteries are used in many of our highest-performing lights, such as Blackout and Nitro. Lithium batteries pack twice the power of alkaline batteries for their weight, and operate well at very cold temperatures. Other lights in the line use AA and AAA alkaline batteries because they cost less than lithium and are readily available anywhere in the world. The latest integrated circuit designs in the Browning Alpha and Crossire flashlights allow alkaline batteries to approach the performance of lithium batteries. The latest Lithium Ion (Li-ion) rechargeable batteries in Alpha Max A-TACS AU and FG offer high energy density with no memory effect and minimal power loss during storage.

SWITCH SETTINGS

Multiple switch settings (high, low and in-between) help preserve battery life and allow selection of colors and flashing options. The lock-out switches found on most of our lights keep the light from accidentally turning on in a pack or pocket. A disorienting fast strobe setting is now available on many of our lights, and it has proven useful for self-protection and for signalling during an emergency.

RED, GREEN AND BLUE

Colored LEDs help preserve night vision and are great for map reading. They are less obvious than white light to many types of game animals.

FL-1 FLASHLIGHT PERFORMANCE STANDARDS

We proudly participate in the FL-1 flashlight performance standards for measuring and stating performance claims for all portable lights. This includes Brightness (Lumens), Distance, Run Time, Water Resistance and Impact Resistance. FL-1 provides the only reliable apples-to-apples comparison between models and is used by most major manufacturers. Look for these FL-1 symbols on our light packaging.*

*On lights with multiple settings, the lumens, battery life and distances are stated at the highest setting (100% power), unless indicated otherwise.



LUMENS = BRIGHTNESS

The output of a traditional 2D cell flashlight is approximately 15 - 20 lumens. The latest LED flashlights can have an output of more than 2000 lumens.



BATTERY LIFE

Battery Life (Run Time) is defined as the time elapsed from when the batteries are new to when the light reaches 10% of the original brightness.

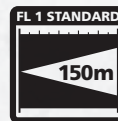

MAXIMUM DISTANCE

Maximum Distance is calculated as the distance from the light source to where it decreases in brightness to 0.25 lux — about the brightness of the full moon on a clear night.



WATER RESISTANCE

Water Resistance (FL-1 Standard IPX4) is tested by spraying water onto the light from multiple directions. This simulates a heavy, all-day rain.

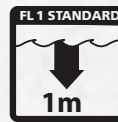

WATERPROOF AND SUBMERSIBLE

Waterproof and Submersible (FL-1 Standard IPX7) assures water cannot get inside the light. This test is conducted for 30 minutes at a water depth of 1 meter (about 39").



IMPACT RESISTANCE

Impact Resistance (FL-1 Standard IM) measures how well the light resists damage when dropped repeatedly from a height of 1 meter (about 39") onto concrete.



IT'S NOT JUST A LIGHT. IT'S THE BROWNING LIGHTING SYSTEM.

Our lights are designed from the ground up to be the most robust and efficient lights on the market. You can choose from a basic flashlight or move up the line to higher-performance lights with expanded lighting capabilities. From small everyday pocket flashlights and headlamps to rail-mounted gun lights and high-output units capable of throwing a blinding beam for hundreds of yards, Browning is the brilliant brand you should always have in your pocket, pack or purse.



MULTIPLE MODE CAPABILITY

- Most of our lights offer a choice of continuous full output, continuous low-output and a rapid strobe mode. Many models also offer multi-color LEDs for specialized tasks and to extend run times for many hours or even days.



MIL-STD 1913 RAIL MOUNT AND REMOTE CABLE SWITCH ENDCAP ACCESSORIES

- Allows many models of our flashlights to be easily attached to any MIL-STD 1913 Picatinny accessory rail that are found on modern sporting rifles, pistols and shotguns.
- Many of our flashlights also accept a remote cable switch endcap accessory that allows the user to activate the light while it is mounted on a long gun.
- The remote switchpad itself may be located on the pistol grip or forearm of a long gun with the included mounting hardware.



PUSH-BUTTON TAILCAP SWITCHES

- The multi-mode push-button tailcap switches allow partial depression giving the user a quick flash for search or identification plus a full depression click to provide a continuous beam for task illumination.
- The textured rubber-covered switch prevents finger slippage during activation.
- The rotating tailcap lock-out prevents accidental activation in a pocket or pack, and a quick twist enables the light.



RUGGED TRAVEL AND STORAGE CASES

- Some of our lights come packaged in rugged polymer cases that provide room for the light and all the necessary power cords, adaptors and other accessories.



INTERCHANGEABLE METAL FRONT BEZEL RINGS

- Several of our lights allow the users to select a smooth bezel for comfortable pocket carry or a strike bezel for self-defense.



MULTIPLE POWER SOURCE CAPABILITY

- Several of our lights utilize the latest generation Lithium Ion (Li-ion) batteries that provide exceptional power density for their size, along with fast recharge times and no memory effect.
- We also have some models that allow battery charging from a standard 110 VAC household wall outlet, a 12 VDC automotive or marine outlet or even a USB port on a laptop or home computer. Users can even recharge from optional portable solar panels that are becoming popular with wilderness adventurers.



INTERCHANGEABLE REAR GLASS-BREAKER POINT

- Many of our tactical lights are equipped with a hardened metal point on the rear bezel that allows the user to break window glass to make an emergency escape from a vehicle or from any glass-enclosed environment.



REMOVABLE ANTI-ROLL METAL FINGER RING

- Several of our flashlights are equipped with a metal anti-roll finger ring to prevent the light from rolling on a sloped surface, and allows the operator to use the "syringe" technique with a defensive handgun.



FL-1 1-METER WATERPROOF CERTIFICATION

- The majority of our lights are certified to meet the latest international FL-1 Standard to operate after being submerged in 1 meter (about 39") of water for 30 minutes. It can be a real lifesaver in a water survival situation.



HELL'S CANYON SPEED ALPHA MAX RECHARGEABLE

LENGTH 4-5/16" **BRIGHTNESS** 155 to 315 lumens **EFFECTIVE DISTANCE** 85 to 150 yards **FEATURES** Advanced digital circuitry uses either a single AA battery or a 14500 Li-ion rechargeable battery • Includes one AA and one 14500 battery and a USB charger • Luxeon® white LED with high and low modes • Single green LED for stealth and night use • Fast strobe mode • Lock-out tailcap switch with momentary and continuous modes • Waterproof • Submersible to 3 feet for 30 minutes • Rugged aircraft grade aluminum construction • Removable Deep Carry Pocket Clip™ • A-TACS AU or FG camo with Dura-Touch Armor Coating

	DESCRIPTION	BATTERIES	BATTERY LIFE	CODE NUMBER	SUGGESTED RETAIL
A	A-TACS AU	(1) AA Alkaline (1) 14500 Lithium	High: 1-2.5 hours Low: 10-16 hours	3711245	119.99
B	A-TACS FG	(1) AA Alkaline (1) 14500 Lithium	High: 1-2.5 hours Low: 10-16 hours	3711247	



HELL'S CANYON SPEED EPIC 3V HEADLAMP

BRIGHTNESS 225 lumens **EFFECTIVE DISTANCE** 100 yards **FEATURES** Rugged polymer body with A-TACS AU or FG camo front • LED life of 100,000 hours • Uses one CR123A 3V battery (included) • Low-profile lamphead design • Soft elastomer headplate for added comfort • Silent beam angle adjustment • Super-bright white LED producing 225 lumens that reaches out to 100 yards • Two lower-output white LEDs are ideal for general use around camp • Two green LEDs provide stealth and protect night vision • Hold down mode switch for 3 seconds to activate Fast-Strobe with white LEDs for safety and emergency signalling

	DESCRIPTION	BATTERIES	BATTERY LIFE	CODE NUMBER	SUGGESTED RETAIL
A	A-TACS AU	(1) CR123A 3V	High: 2 hours Low: 24 hours	3718660	44.99
B	A-TACS FG	(1) CR123A 3V	High: 2 hours Low: 24 hours	3718670	



HELL'S CANYON SPEED NIGHT SEEKER 2 CAP LIGHT

BRIGHTNESS 19 lumens **EFFECTIVE DISTANCE** 22 yards **FEATURES** Our most popular cap lights with over 2 million sold • Clip to the brim of a cap, on a pocket or pack strap or use as a freestanding light • Adjusts to aim the light where it's needed • A-TACS AU or FG camo on clip • Two white LEDs produce 19 lumens plus two green LEDs for stealth and better night vision

	DESCRIPTION	BATTERIES	BATTERY LIFE	CODE NUMBER	SUGGESTED RETAIL
A	A-TACS AU	(2) 2032 Lithium	White LEDs: 10 hours Green LEDs: 48 hours	3715120	14.99
B	A-TACS FG	(2) 2032 Lithium	White LEDs: 10 hours Green LEDs: 48 hours	3715130	





BLACK LABEL DISRUPTER LED SEARCHLIGHT

LENGTH 7" **BRIGHTNESS** 2600 lumens maximum **EFFECTIVE DISTANCE** 75 to 500 yards
FEATURES Three super-bright white LEDs • Three red LEDs and three green LEDs for stealth, safety and improved night vision • Rotary sleeve on switch protects against accidental light activation in pack or pocket • Thumb switch for momentary or continuous lighting • Select from high, medium or low output on white LEDs, plus green, red and fast strobe modes • All-aluminum body construction with optically clear scratch-resistant glass lens is built for years of rugged duty • Anti-roll bezel profile • Heat dissipating fins on lamphead • 10400 mAh rechargeable lithium-ion battery is rated at 500 charge cycles • Comes complete with household (AC) and vehicle (DC) chargers and all cords, including USB • Water-resistant (ANSI IPX4 standard)

BATTERIES	BATTERY LIFE	CODE NUMBER	SUGGESTED RETAIL
10400 mAh Lithium Ion Rechargeable	High: 2 hours Low white: 80 hours	3714100	384.99



HIGH NOON SPOTLIGHTS

LENGTH 5-3/4" **BRIGHTNESS** 105 to 1000 lumens depending on model **EFFECTIVE DISTANCES** 400 to 725 yards depending on model **FEATURES** Powerful white LED that never needs replacing • Lightweight compact designs gives incredible output (batteries not included, except in the rechargeable model) • Fast strobe setting for signaling • Waterproof • Submersible to three feet for 30 minutes • Floats • Lock-out switch on handle • Black models offer a rubberized soft touch finish • Rugged polycarbonate housing and flexible rubber lens ring • Built-in adjustable stand for hands free use • Lanyard included • Long run times on high output and low output settings • Available in Black, Hi-Viz Yellow and Mossy Oak® Shadow Grass Blades camo • Green Extreme model has green LED for night varmint hunting (where legal) and a single high-output mode with no strobe setting



NEW 2016	DESCRIPTION	BATTERIES	BATTERY LIFE	EFFECTIVE DISTANCE	LUMENS	CODE NUMBER	SUGGESTED RETAIL
HIGH NOON RECHARGEABLE							
A	• Rechargeable	Rechargeable Li-ion	High: 1.1 hours Low: 24 hours	550 yards	High: 850 Low: 50	3717765	109.99
3C HIGH NOON SPOTLIGHTS							
B	Hi-Viz Yellow	(3) C Alkaline	High: 3 hours Low: 72 hours	400 yards	High: 500 Low: 92	3717750	69.99
C	Dirty Bird, MOSGB	(3) C Alkaline	High: 3 hours Low: 72 hours	400 yards	High: 500 Low: 92	3717740	79.99
D	Green Extreme	(3) C Alkaline	High: 30 hours	285 yards	150	3717730	
E	Black	(3) C Alkaline	High: 12 hours Low: 96 hours	475 yards	High: 625 Low: 55	3717710	69.99
4C HIGH NOON SPOTLIGHTS							
F	Hi-Viz Yellow	(4) C Alkaline	High: 3 hours Low: 200 hours	645 yards	High: 825 Low: 80	3717790	84.99
G	Black	(4) C Alkaline	High: 9 hours Low: 72 hours	725 yards	High: 1000 Low: 90	3717760	

**NEW
2016**



HELLCAT

LENGTH 5-3/4" **BRIGHTNESS** 610 lumens with two CR123A batteries (included) or 825 lumens with optional 18650 Li-ion battery (not included) **EFFECTIVE DISTANCE** 250 to 285 yards **FEATURES** The ultimate hunting flashlight with a super bright white, long distance beam • Soft green LEDs for stealth and safety • Mode selector lets you pick desired mode without toggling • Single-action tailcap switch with momentary and continuous modes • Incredible 40 hour run time on low output with CR123A batteries or 60 hours with optional 18650 Li-ion battery • Aluminum body with polycarbonate lens and internal battery magazine • Waterproof • Submersible to 3 feet for 30 minutes

BATTERIES	BATTERY LIFE	CODE NUMBER	SUGGESTED RETAIL
(2) CR123A Lithium, Optional 18650 Li-ion	High: 1.5-2.45 hours Low: 40-60 hours	3714210	109.99



BLACKOUT

LENGTH 5-1/2" **BRIGHTNESS** 650 lumens **EFFECTIVE DISTANCE** 295 yards **FEATURES** Our brightest CR123A two-battery flashlight • Powerful white LED that never needs replacing • Lock-out tailcap switch with momentary, continuous and fast strobe modes • Non-slip body and anti-roll finger retention ring • All-aluminum body construction with optically clear scratch-resistant glass lens • Waterproof • Submersible to 3 feet for 30 minutes • Drop tested to 1 meter • Incredible 60 hour run time on low output • CR123A batteries operate to -40° F and have 10 year shelf life

BATTERIES	BATTERY LIFE	CODE NUMBER	SUGGESTED RETAIL
(2) CR123A Lithium	High: 2 hours Low: 60 hours	3713410	109.99



CATALYST

LENGTH 5" **BRIGHTNESS** 300 lumens **EFFECTIVE DISTANCE** 200 yards **FEATURES** Luxeon® LED • Lock-out tailcap switch with momentary, continuous and fast strobe modes • Removable Deep Carry Pocket Clip™ • Incredible 48 hour run time on low output • CR123A batteries operate to -40° F • All-aluminum body construction with unbreakable lens • Waterproof • Submersible to 3 feet for 30 minutes • Vista® camo with Dura-Touch Armor Coating

BATTERIES	BATTERY LIFE	CODE NUMBER	SUGGESTED RETAIL
(2) CR123A Lithium	High: 3 hours Low: 48 hours	3711230	79.99

DURA-TOUCH®
Armor Coating



CATALYST EXTREME GREEN VARMINT LIGHT

LENGTH 5" **BRIGHTNESS** 150 lumens **EFFECTIVE DISTANCE** 200 yards **FEATURES** Green Luxeon® LED • Lock-out tailcap switch with full output momentary and continuous modes • Deep Carry Pocket Clip™ • 6 hour run time • CR123A batteries operate to -40° F • All-aluminum body construction with unbreakable lens • Waterproof • Submersible to 3 feet for 30 minutes • Matte black finish • Includes 1913 Picatinny rail mount and remote cable switch

BATTERIES	BATTERY LIFE	CODE NUMBER	SUGGESTED RETAIL
(2) CR123A Lithium	High: 6 hours	3711244	109.99



A



B



ALPHA MAX

LENGTH 4-5/16" **BRIGHTNESS** 155 to 315 lumens **EFFECTIVE DISTANCE** 85 to 150 yards **FEATURES** Advanced digital circuitry accepts either a single AA alkaline battery (included) to produce 155 lumens or a single 14500 rechargeable lithium-ion battery (not included) to produce 315 lumens • High power white LED with high and low modes • Single green LED for stealth and improved night vision • Lock-out tailcap switch with momentary and continuous modes • Waterproof • Submersible to 3 feet for 30 minutes • Rugged aircraft grade aluminum construction • Removable Deep Carry Pocket Clip™ • Camo model features Dura-Touch Armor Coating

	DESCRIPTION	BATTERIES	BATTERY LIFE	CODE NUMBER	SUGGESTED RETAIL
A	Black	(1) AA Alkaline or (1) 14500 Lithium	High: 1-2.5 hours Low: 10-16 hours	3711239	54.99
B	Vista Camo	(1) AA Alkaline or (1) 14500 Lithium	High: 1-2.5 hours Low: 10-16 hours	3711232	64.99

DURA-TOUCH®
Armor Coating



ALPHA

LENGTH 4" **BRIGHTNESS** 155 lumens **EFFECTIVE DISTANCE** 85 yards **FEATURES** Advanced digital circuitry delivers maximum light output using a single AA alkaline battery (included) • Unbreakable white LED • High, low and fast strobe modes • Lock-out tailcap switch with momentary and continuous modes • Waterproof • Submersible to 3 feet for 30 minutes • Rugged aircraft grade aluminum construction • Removable Deep Carry Pocket Clip™

BATTERIES	BATTERY LIFE	CODE NUMBER	SUGGESTED RETAIL
(1) AA Alkaline	High: 2.5 hours Low: 16 hours	3711231	49.99



MICROBLAST AAA FLASHLIGHT

LENGTH 2-7/8" **BRIGHTNESS** 60 lumens **EFFECTIVE DISTANCE** 42 yards **FEATURES** Uses a single AAA alkaline battery • White LED is brighter than many 2 D flashlights • Digital circuitry delivers maximum power • Twist switch for easy lock on and off • Deep Carry Pocket Clip™ • All-aluminum construction with unbreakable lens • O-ring sealed • Waterproof to 3 feet for 30 minutes • Passes drop-test onto concrete from a height of more than one meter • Use as flashlight or cap light

BATTERIES	BATTERY LIFE	CODE NUMBER	SUGGESTED RETAIL
(1) AA Alkaline	1.5 hours	3712114	24.99



A

B

CROSSFIRE

LENGTH 6" **BRIGHTNESS** 250 lumens **EFFECTIVE DISTANCE** 150 yards **FEATURES** Uses two standard AA alkaline batteries (included) • Advanced digital circuitry • Unbreakable white LED • Rugged, lightweight polymer body • Diffuser dome attachment for soft area light and signaling beacon • Lanyard • O-ring sealed • Waterproof • Submersible to 3 feet for 30 minutes • Lock-out tailcap switch with high, low and strobe modes • 16 hour run time on low • Molded-in Buckmark logo

	DESCRIPTION	BATTERIES	BATTERY LIFE	CODE NUMBER	SUGGESTED RETAIL
A	Black	(2) AA Alkaline	High: 2 hours Low: 16 hours	3713310	34.99
B	Coyote Tan	(2) AA Alkaline	High: 2 hours Low: 16 hours	3713370	



CLASSIC PRO

LENGTH 5-1/4" **BRIGHTNESS** 165 lumens **EFFECTIVE DISTANCE** 115 yards
FEATURES Vista camo polymer body • Matte black aluminum lens ring
 • Center white LED for long distance illumination • Tactical tailcap switch has high, low and flashing modes • Waterproof to FL 1 meter standard
 • Submersible to 3 feet for 30 minutes • Lock-out feature protects the batteries • Uses affordable and easy to find AAA batteries (included)

BATTERIES	BATTERY LIFE	CODE NUMBER	SUGGESTED RETAIL
(3) AAA Alkaline	High: 3 hours Low: 24 hours	3713322	44.99

NEW 2016



PRO HUNTER LED

LENGTH 5-1/4" **BRIGHTNESS** 110 lumens **EFFECTIVE DISTANCE** 100 yards
FEATURES Matte black or Vista camo polymer body • Matte black or matte silver aluminum lens ring • Tactical-style lock-out end cap assures the light is not turned on accidentally • Carrying lanyard • Center white LED for long distance illumination • Two red and two green LEDs for stealth, safety and improved night vision • Waterproof to FL 1 meter standard
 • Submersible to 3 feet for 30 minutes • Uses affordable and easy to find AAA batteries (included)

NEW 2016	DESCRIPTION	BATTERY LIFE	CODE NUMBER	SUGGESTED RETAIL
A	• Black	White: 8 hours Green/Red: 50 hours	3713352	29.99
B	Vista Camo	White: 8 hours Green/Red: 50 hours	3713312	39.99



PRO HUNTER RGB

LENGTH 5-1/4" **BRIGHTNESS** 40 lumens **EFFECTIVE DISTANCE** 27 yards
FEATURES Black polymer body with matte aluminum lens ring
 • Tactical-style lock-out end cap assures the light is not turned on accidentally • Carrying lanyard • Two high-intensity LEDs for long distance illumination • One wide view LED for maximum peripheral vision • One red-green-blue LED for stealth, safety and improved night vision • Waterproof to FL 1 meter standard • Submersible to 3 feet for 30 minutes • Uses affordable and easy to find AAA batteries (included)

BATTERIES	BATTERY LIFE	CODE NUMBER	SUGGESTED RETAIL
(3) AAA Alkaline	High+Wide: 25 hours High: 30 hours RGB: 40 hours	3713314	24.99



BLACK LABEL TACTICAL 9V FLASHLIGHT

LENGTH 8-1/2" **BRIGHTNESS** 825 lumens **EFFECTIVE DISTANCE** 575 yards **FEATURES** Powerful white LED never needs replacing • Tactical lock-out tailcap switch • Momentary, continuous and fast strobe modes • Removable anti-roll finger retention ring • Non-slip all-aluminum body construction • Interchangeable smooth and crenelated front bezels • Interchangeable hardened glass breaking point mounted on robust aluminum alloy tailcap • Optically clear scratch-resistant glass lens • Waterproof • Submersible to 3 feet for 30 minutes • Drop tested to 1 meter • Incredible 60 hour run time on low output • Uses three CR123A batteries (included) • Mounts on rifles and shotguns with optional 1913 Picatinny rail mount and remote cable switch (sold separately)

BATTERIES	BATTERY LIFE	LUMENS	CODE NUMBER	SUGGESTED RETAIL
(3) CR123A Lithium	High: 2 hours; Low: 60 hours	High: 825 Low: 20	3713205	144.99



BLACK LABEL TACTICAL 6V FLASHLIGHT

LENGTH 5-3/4" **BRIGHTNESS** 650 lumens **EFFECTIVE DISTANCE** 295 yards **FEATURES** Powerful white LED never needs replacing • Tactical lock-out tailcap switch • Momentary, continuous and fast strobe modes • Removable anti-roll finger retention ring • Non-slip all-aluminum body construction • Interchangeable smooth and crenelated front bezels • Interchangeable hardened glass breaking point mounted on robust aluminum alloy tailcap • Optically clear scratch-resistant glass lens • Waterproof • Submersible to 3 feet for 30 minutes • Drop tested to 1 meter • Incredible 60 hour run time on low output • Uses two CR123A batteries (included) • Mounts on rifles and shotguns with optional 1913 Picatinny rail mount and remote cable switch (sold separately)

BATTERIES	BATTERY LIFE	LUMENS	CODE NUMBER	SUGGESTED RETAIL
(2) CR123A Lithium	High: 2 hours; Low: 60 hours	High: 650 Low: 20	3713204	109.99



BLACK LABEL TACTICAL 3V FLASHLIGHT

LENGTH 4-1/2" **BRIGHTNESS** 260 lumens **EFFECTIVE DISTANCE** 165 yards **FEATURES** Powerful white LED never needs replacing • Tactical lock-out tailcap switch • Momentary, continuous and fast strobe modes • Removable anti-roll finger retention ring • Non-slip all-aluminum body construction • Interchangeable smooth and crenelated front bezels • Interchangeable hardened glass breaking point mounted on robust aluminum alloy tailcap • Optically clear scratch-resistant glass lens • Waterproof • Submersible to 3 feet for 30 minutes • Drop tested to 1 meter • Incredible 24 hour run time on low output • Uses one CR123A battery (included) • Mounts on rifles and shotguns with optional 1913 Picatinny rail mount and remote cable switch (sold separately)

BATTERIES	BATTERY LIFE	LUMENS	CODE NUMBER	SUGGESTED RETAIL
(1) CR123A Lithium	High: 2 hours; Low: 24 hours	High: 260 Low: 10	3713203	74.99



BLACK LABEL TACTICAL 1AA FLASHLIGHT

LENGTH 4-1/4" **BRIGHTNESS** 120 lumens **EFFECTIVE DISTANCE** 90 yards **FEATURES** Powerful white LED never needs replacing • Tactical lock-out tailcap switch • Momentary, continuous and fast strobe modes • Removable anti-roll finger retention ring • Non-slip all-aluminum body construction • Interchangeable smooth and crenelated front bezels • Interchangeable hardened glass breaking point mounted on robust aluminum alloy tailcap • Optically clear scratch-resistant glass lens • Waterproof • Submersible to 3 feet for 30 minutes • Drop tested to 1 meter • Incredible 20 hour run time on low output • Uses one AA battery (included) • Mounts on rifles and shotguns with optional 1913 Picatinny rail mount and remote cable switch (sold separately)

BATTERIES	BATTERY LIFE	LUMENS	CODE NUMBER	SUGGESTED RETAIL
(1) AA Alkaline	High: 1.5 hours; Low: 20 hours	High: 120 Low: 14	3713202	54.99





BLACK LABEL PICATINNY RAIL MOUNTS AND REMOTE CABLE SWITCHES

MOUNTS FEATURE Rugged matte black all-aluminum construction • Allows easy mounting of Black Label AA, 3V and 6V or 9V flashlights on rifles and shotguns with MIL-STD 1913 Picatinny rails • Also fits many of our AA and CR123 sporting flashlights • Molded rubber ring improves fit and acts as a recoil vibration damper • Built-in rail key prevents slipping once mounted on the rail • Thumbscrew adjustable mount • Installation screwdriver is included **REMOTE SWITCHES FEATURE** Rugged construction • Replaces factory tailcap switch to allow remote activation of Black Label AA or CR123A flashlights mounted on rifles and shotguns • Also fits many of our sporting flashlights including Alpha, Alpha Max and Catalyst (CR123 model) • Easily attached with two adjustable straps to pistol grip or forearm • Large momentary switch pad is easy to access, even with gloves • Push to activate light, release to turn off

	DESCRIPTION	CODE NUMBER	SUGGESTED RETAIL
A	Picatinny Rail Mount for AA, 3V, and 6V Flashlights	3743210	24.99
	Picatinny Rail Mount for 9V Flashlight	3743211	
B	Remote Cable Switch for AA Flashlight	3743212	
	Remote Cable Switch for 3V, 6V, 9V Flashlights	3743213	



BLACK LABEL EDC PISTOL LIGHT

LENGTH 3-1/2" **BRIGHTNESS** 205 lumens **EFFECTIVE DISTANCE** 125 yards **FEATURES** Powerful white LED never needs replacing • Designed for everyday pocket carry and firearm mounting • Tactical tailcap switches are fully ambidextrous • Momentary, continuous and fast strobe modes • Non-slip polymer body • Interchangeable smooth and crenelated metal front bezel rings • Lockout function via rotating front bezel • Optically clear scratch-resistant glass lens • Deep Carry Pocket Clip™ • Drop tested to 1 meter • Incredible 24 hour run time on low output • Uses one CR123A battery (included) • Mounts instantly on pistols, rifles and shotguns in multiple positions using the included mounting bracket • Bracket mounts on all 1913 Picatinny rails • Two rail bolts included

BATTERIES	BATTERY LIFE	LUMENS	CODE NUMBER	SUGGESTED RETAIL
(1) CR123A Lithium	High: 2 hours; Low: 24 hours	High: 205 Low: 10	3713206	79.99



EDC Light Module shown in firearm-mounted configuration.



Two ambidextrous side tailcap switches are easy to access with either hand for momentary lighting. A single under-switch enables continuous lighting in high, low and strobe modes.



The rail bracket remains on the MIL-STD 1913 Picatinny rail of the firearm. The EDC Light Module instantly mounts to the rail.



BLACK LABEL TACTICAL CAP LIGHT/KNIFE COMBO

BRIGHTNESS 19 lumens **EFFECTIVE DISTANCE** 22 yards **FEATURES** Two white LEDs and two red LEDs • 10 hour run time on white • 48 hour run time on red • Tilting design attaches to cap brim, pocket or pack strap • Uses two 2032 batteries (included) **RUSS KOMMER DESIGNED KNIFE** Frame lock design • 2-1/2" 440 stainless steel blade • Tanto point with partially serrated edge • Textured handle scales

BATTERIES	BATTERY LIFE	CODE NUMBER	SUGGESTED RETAIL
(2) 2032 Button	White: 10 hours; Red: 48 hours	3713201	24.99





4-IN-1 SURVIVOR PEN LIGHT

BRIGHTNESS 12 lumens **EFFECTIVE DISTANCE** 22 yards
FEATURES Innovative combination of flashlight, cap light, writing pen and a tactical glass breaker with hardened tungsten carbide point • Elegant yet rugged all-aluminum construction • 100,000 hour white LED • 8 hour run time • Lock on/lock off twist switch • Pocket clip • Uses four LR41 button batteries • Cap shown not included

BATTERIES	BATTERY LIFE	CODE NUMBER	SUGGESTED RETAIL
(4) LR41 Button	8 hours	3712130	19.99

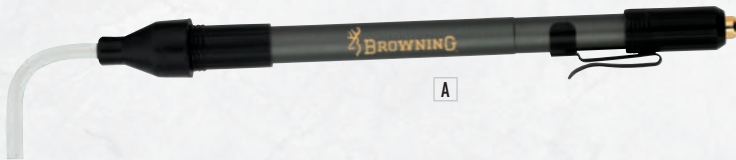

A



B

MICROBLAST PEN LIGHTS

BRIGHTNESS 2 AAA: 60 lumens • 3 AAAA: 15 lumens **EFFECTIVE DISTANCE** 2 AAA: 40 yards • 3 AAAA: 22 yards
FEATURES Rugged all-aluminum construction • Deep Carry spring steel pocket clip • Clear plastic bore light adaptor included • Model 3712123 uses two AAA batteries and is 4 to 10 times brighter than many other pen lights • Model 3712120 uses three AAAA batteries and has a Covert Cover to make the light unseen from the side • Waterproof to FL 1 meter standard • Submersible to 3 feet for 30 minutes • Drop tested to 3 feet

	MODEL	BATTERIES	BATTERY LIFE	CODE NUMBER	SUGGESTED RETAIL
A	3 AAAA with Bore Light Adaptor	(3) AAAA Alkaline	35 hours	3712120	19.99
B	2 AAA with Bore Light Adaptor	(2) AAA Alkaline	2-1/2 hours	3712123	



BLACKOUT 6V HEADLAMP

BRIGHTNESS 635 lumens **EFFECTIVE DISTANCE** 165 yards **FEATURES** Powerful white LED never needs replacing • Four brightness settings plus strobe mode • Silent Tilt Hinge for added stealth • Soft rubber head plate for added comfort • Ultra tough anodized all-aluminum body construction • Waterproof • Submersible to 3 feet for 30 minutes • Drop tested to 1 meter • Incredible 48 hour run time on low output • Uses two CR123A batteries (included)

BATTERIES	BATTERY LIFE	EFFECTIVE DISTANCE	LUMENS	CODE NUMBER	SUGGESTED RETAIL
(2) CR123A Lithium	High: 3 hours; Low: 48 hours	165 yards	High: 635; Low: 30	3713340	99.99



A



B

EPIC

BRIGHTNESS 20 or 225 lumens **EFFECTIVE DISTANCE** 27 or 100 yards
FEATURES Single battery power source • Rugged matte black polymer body with Vista® camo front • LED life of 100,000 hours • Low-profile lamphead design • Soft elastomer headplate for added comfort • Silent Tilt angle adjustment allows beam to be moved up or down • 1 AA Model uses two white LEDs to produce 20 lumens for general use around camp • Two green LEDs provide stealth and protect night vision • Hold down switch for 3 seconds to activate Fast-Strobe with white LEDs • 3V model has super-bright white LED producing 225 lumens that reaches out to 100 yards • Two lower output white LEDs are ideal for general use around camp • Two green LEDs offer stealth and protect night vision

DESCRIPTION	BATTERIES	BATTERY LIFE	CODE NUMBER	SUGGESTED RETAIL
A 1AA	(1) AA Alkaline	White: 6 hours Green: 8 hours	3718640	24.99
B 3V	(1) CR123A 3V	High: 2 hours Low: 8 hours	3718650	44.99

**NITRO**

BRIGHTNESS 255 lumens **EFFECTIVE DISTANCE** 150 yards **FEATURES** Advanced digital circuitry delivers maximum light output using a single CR123A lithium battery • Powerful white LED plus two red and two green LEDs are rated for 100,000 hour service life • Lock-out switch with settings for high and low output • Battery operates to -40° F • Glass-fiber reinforced polycarbonate housing with aluminum lens ring • Silent Hinge minimizes unwanted noise • Body and headstrap in Vista® camo

BATTERIES	BATTERY LIFE	CODE NUMBER	SUGGESTED RETAIL
(1) CR123A Lithium	High: 2 hours Low: 24 hours	3718620	64.99

**MAXUS**

BRIGHTNESS 170 lumens **EFFECTIVE DISTANCE** 70 yards **FEATURES** Zoom lever adjusts the focus of the main LED from spot to flood • Powerful LED puts out 170 lumens for an effective range of 70 yards • Three light output levels (high, medium, low) and flash mode • Two green and two red LEDs offer maximum stealth, safety and help protect night vision • Maximum run time on low of 48 hours • Memory switch returns to the most recent setting when the light is turned on • Black front panel with charcoal accents

BATTERIES	BATTERY LIFE	CODE NUMBER	SUGGESTED RETAIL
(3) AAA Alkaline	High: 3.5 hours Low: 48 hours	3713329	44.99

**BLACK LABEL TACTICAL 1AA HEADLAMP**

BRIGHTNESS 125 lumens **EFFECTIVE DISTANCE** 75 yards **FEATURES** Powerful white LED never needs replacing • Lock out battery cap • Two brightness settings plus strobe mode • Silent Tilt eliminates noise when tilting the light up or down • Soft rubber head plate for added comfort • Ultra tough anodized all-aluminum body construction • Optically clear scratch-resistant glass lens • Waterproof • Submersible to 3 feet for 30 minutes • Drop tested to 1 meter • 20 hour run time on low output • Uses one AA battery (included)

BATTERIES	BATTERY LIFE	LUMENS	CODE NUMBER	SUGGESTED RETAIL
(1) AA Alkaline	High: 1.5 hours; Low: 20 hours	High: 125; Low: 10	3713230	54.99

**MICROBLAST HEADLAMP**

BRIGHTNESS 10 lumens **EFFECTIVE DISTANCE** 16 yards **FEATURES** Ultralight headlamp • Super bright yet so small you won't notice it when worn • Two Nichia® white LEDs • One green LED • Rugged polymer construction with Silent Hinge • Headstrap for use as a headlamp • Clip to attach to a cap

BATTERIES	BATTERY LIFE	CODE NUMBER	SUGGESTED RETAIL
(2) 2032 Lithium	White: 5 hours Green: 33 hours	3712121	17.99



BUCKMARK CAP LIGHT

BRIGHTNESS 13 lumens on white • 6 lumens on green **EFFECTIVE DISTANCE** 10 to 20 yards **FEATURES** Colorful metal Buckmark slides on to brim of hat • Locking push-button switch • One white LED for close-up task illumination • One green LED for stealth and better night vision • 9 hour run time on white • 12 hour run time on green • Uses two 2016 coin cell batteries (included) • Cap shown not included



MODEL	BATTERIES	BATTERY LIFE	CODE NUMBER	SUGGESTED RETAIL
A Black	(2) 2016 Coin	White: 9 hours, Green: 12 hours	3716110	12.99
B Gold	(2) 2016 Coin	White: 9 hours, Green: 12 hours	3716130	13.99
C Silver	(2) 2016 Coin	White: 9 hours, Green: 12 hours	3716120	12.99
D Pink	(2) 2016 Coin	White: 9 hours, Green: 12 hours	3716140	12.99



NIGHT SEEKER CAP LIGHTS

BRIGHTNESS 15 to 60 lumens **EFFECTIVE DISTANCE** 22 to 50 yards **FEATURES** Our most popular cap lights with over 2 million sold • Clip to the brim of a cap, on a pocket or pack strap or use as a freestanding light • Adjusts to aim the light where it's needed • Night Seeker RGB: Two white LEDs produce 15 lumens, plus red, green or blue from a center LED • Vista® camo clip • Night Seeker 2: Two white LEDs produce 19 lumens plus two green LEDs for stealth and better night vision • Night Seeker Pro: One white LED produces 60 lumens plus two green LEDs for stealth and night use

MODEL	BATTERIES	BATTERY LIFE	CODE NUMBER	SUGGESTED RETAIL
A Night Seeker RGB, Vista Camo on clip	(2) 2032 Lithium	White LEDs: 6.5 hours RGB LEDs: 15 hours	3715100	17.99
B Night Seeker 2, Black	(2) 2032 Lithium	White LEDs: 10 hours Green LEDs: 48 hours	3715081	12.99
C Night Seeker Pro, Black	(1) AAA Alkaline	White LED: 2 hours 2 Green LEDs: 4 hours	3715099	19.99



SUPER CAP LIGHT

BRIGHTNESS 102 lumens **EFFECTIVE DISTANCE** 60 yards **FEATURES** Our brightest cap light • Brighter than many flashlights • One white powerful LED for distance and maximum brightness • Two Nichia LEDs for close-up illumination • 35 minute run time on high • 6 hour run time on low • Uses one AAA battery (included) • Clips to brim of hat with spring steel bail

BATTERIES	BATTERY LIFE	CODE NUMBER	SUGGESTED RETAIL
(1) AAA Alkaline	High: 35 minutes Low: 6 hours	3715200	34.99



ZIPPER PULL KEYCHAIN LIGHT

BRIGHTNESS 13 lumens white, 3-6 lumens red, green **EFFECTIVE DISTANCE** 10-20 yards **FEATURES** Attaches to a key ring or zipper pull with the pull cord • Buckmark has one white LED and one green LED • Black Label has one white LED and one red LED • Lock-on/lock-off switch • 9 hour run time using white LED • 12 hour run time using colored LED • Rubberized polymer body with spring steel back plate and clip

	DESCRIPTION	BATTERIES	BATTERY LIFE	CODE NUMBER	SUGGESTED RETAIL
A	Black w/Pink Buckmark	(2) 2016 Coin Cell	White: 9 hours Green: 12 hours	3713375	12.99
B	Black Label	(2) 2016 Coin Cell	White: 9 hours Green: 12 hours	3713385	



EDGE KEYCHAIN LIGHT/KNIFE

BRIGHTNESS 12 lumens **EFFECTIVE DISTANCE** 20 yards **FEATURES** Keychain light with a built-in liner lock knife with a 3/4" stainless steel blade • White Nichia 5mm LED for close-up illumination • Lock-on/lock-off switch • 4 hour run time • Uses two replaceable 2016 coin-cell batteries (included)

	DESCRIPTION	BATTERIES	BATTERY LIFE	CODE NUMBER	SUGGESTED RETAIL
A	Black	(2) 2016 Coin-Type	4 hours	3713395	14.99
B	Pink	(2) 2016 Coin-Type	4 hours	3713397	



BLACK LABEL APPROACH TACTICAL KEYCHAIN LIGHT AND LIGHT/KNIFE COMBO

LIGHT LENGTH 2-1/4" **BRIGHTNESS** 18 lumens **EFFECTIVE DISTANCE** 22 yards with white LEDs • 50 yards with red laser **FEATURES** Powerful keychain light quickly unbuckles from key ring and attaches to a pistol or other firearm • Two white LEDs plus one 5mW red laser for intimidation • Mounts on any MIL-STD 1913 Picatinny rail • Dual push-button switches on underside • LEDs and laser can be turned on separately or at the same time • 4 hour run time on LEDs • Rugged polymer construction with molded rail grabbers and rail key • Uses two 2016 coin-type batteries (included) • Laser is a directional pointer only and is not intended for use as a targeting indicator or firearm aiming device **KNIFE** Designed by Russ Kommer • Liner lock construction • 1-3/8" 5Cr stainless steel bead blasted blade • Checkered glass filled polymer handles • Knife quickly detaches from keychain

	DESCRIPTION	BATTERIES	BATTERY LIFE	CODE NUMBER	SUGGESTED RETAIL
A	Approach	(2) 2016 Coin-Type	4 hours on LEDs	3713208	24.99
B	Approach Tactical Combo	(2) 2016 Coin-Type	4 hours on LEDs	3713209	



CHOKE TUBE KEYCHAIN LIGHTS

BRIGHTNESS 12 lumens **EFFECTIVE DISTANCE** 22 yards **FEATURES** Nichia® high intensity white LED • O-ring sealed for water-resistance • Rugged aircraft grade aluminum construction • Twist switch for easy on and off • Includes four LR41 batteries • Up to 8 hours of continuous run time • Metal snap clip

	MODEL	BATTERIES	BATTERY LIFE	CODE NUMBER	SUGGESTED RETAIL
A	Midas, Black/Gold	(4) LR41	8 hours	N/A	12.99
B	Goose Band, Silver/Black	(4) LR41	8 hours	N/A	
C	Full Strut, Black/Camo	(4) LR41	8 hours	N/A	



ZPK COMBO **NEW 2016**

BRIGHTNESS 13 lumens white, 3-6 lumens red, green **EFFECTIVE DISTANCE** 10-20 yards **FEATURES** Attach to a key ring or zipper pull with the pull cord • One white LED and one green LED • Lock-on/lock-off switch • 9 hour run time using white LED • 12 hour run time using green LED • Rubberized polymer body with spring steel back plate and clip • Ultra-thin folding lockback knife • 7Cr stainless blade • Black handle with neon color accent

	DESCRIPTION	BATTERIES	BATTERY LIFE	CODE NUMBER	SUGGESTED RETAIL
A	Slate/Black	(2) 2016 Coin-cell	White: 9 hours Green: 12 hours	3710060	24.99
B	Green/Black	(2) 2016 Coin-cell	White: 9 hours Green: 12 hours	3710061	
C	Pink/Black	(2) 2016 Coin-cell	White: 9 hours Green: 12 hours	3710063	
D	Orange/Black	(2) 2016 Coin-cell	White: 9 hours Green: 12 hours	3710062	



MICROBLAST COMBO

FLASHLIGHT LENGTH 2-7/8" **BRIGHTNESS** 15 lumens **EFFECTIVE DISTANCE** 22 yards **FEATURES** 5mm LED is brighter than many two AA flashlights • Digital circuitry delivers maximum power using only one AAA battery • All aluminum body construction with unbreakable lens • O-ring sealed for water resistance • Deep Carry Pocket Clip™ **MICROBLAST KNIFE** Folding knife with durable frame lock • 2" stainless steel blade holds a sharp edge

BATTERIES	BATTERY LIFE	CODE NUMBER	SUGGESTED RETAIL
(1) AAA Alkaline	7 hours	3712118	29.99



NIGHT SEEKER 2 COMBOS

CAP LIGHT BRIGHTNESS 19 lumens **EFFECTIVE DISTANCE** 22 yards **FEATURES** Two white LEDs for general lighting • Two green LEDs for stealth and night use • Protected sliding switch prevents accidental activation in pocket or pack • Uses two 2032 batteries (included) • Clip adjusts to aim light where it's needed • Clip to the brim of a cap, on a pocket or a pack strap or use as a freestanding light **RUSS KOMMER DESIGNED KNIVES** Folding liner-lock with rugged aluminum handles • Razor-sharp 2-1/4" 440 stainless steel blade • Camo models features Dura-Touch Armor Coating • Thumbstud and pocket clip

DURA-TOUCH
Armor Coating

	MODEL	BATTERIES	BATTERY LIFE	CODE NUMBER	SUGGESTED RETAIL
A	Black/Black	(2) 2032 Lithium	White LEDs: 10 hours Green LEDs: 48 hours	3715095	19.99
B	Vista/Vista	(2) 2032 Lithium	White LEDs: 10 hours Green LEDs: 48 hours	3715096	29.99
C	Black/Vista	(2) 2032 Lithium	White LEDs: 10 hours Green LEDs: 48 hours	3715098	24.99



BATTERIES

CR123A: Packed two per blister card • Used in Blackout, Catalyst, Epic 3V, Nitro and in several models of Black Label tactical lights **2032:** Packed four per blister card • Used in Night Seeker 2 Cap Lights and many popular red-dot electronic sights

	MODEL	CODE NUMBER	SUGGESTED RETAIL
A	CR123A Batteries (2-Pack)	3742000	6.99
B	2032 Batteries (4-Pack)	3742100	5.99



**APPAREL READY
FOR ALL OF
YOUR ADVENTURES.**

2016 is a big year for Browning Apparel. In this section, you'll have the opportunity to view our all new Hell's Canyon Speed — a complete line of the most technologically advanced hunting apparel we have ever produced. If you've followed us for a while, you know that's a bold claim coming from the company that has brought you some of the finest hunting gear in history.

In addition to big game gear, you'll find new products and improvements spanning every category to ensure that when you choose Browning apparel, you're getting The Best There Is.

APPAREL

The Browning logo, featuring a stylized silhouette of a buck's head with large, curved antlers, positioned at the bottom of the vertical text column. A registered trademark symbol (®) is located at the bottom right of the logo.

ADVANTAGE BROWNING.

Every hunter needs something different from their outdoor clothing and our broad spectrum covers them better than anyone. New Hell's Canyon Speed is built to go the distance with a wide selection of top notch gear to keep extreme hunters warm, dry and comfortable. Hell's Canyon and Hell's Belles offer men and women high quality gear built to survive hunt after hunt. Wasatch gives every member of the family the best bang for their buck. Whether you need the best gear or the best value, look to Browning.



HELL'S CANYON SPEED — NEW DESIGNS, FABRICS AND FIT.

To find a trophy buck or bull, you need to be willing to go where other hunters won't — Hell's Canyon Speed will take you there. Hell's Canyon Speed is on point, using the very latest design technology and independent testing to ensure that the fabrics we've developed can endure the rigors hunters put their gear through. HeroFit tailoring trims away excess weight and bulk, while the abrasion resistant, stretchable fabrics maximize freedom of movement for unmatched durability, mobility and comfort. Proprietary A-TACS camo provides superior concealment. Designed as a system, Speed garments are sized to comfortably layer over one another to retain the fit while adding protection from the elements. With Hell's Canyon Speed you can hunt harder, faster and in greater comfort than ever before.



HELL'S CANYON — SEE YOU THERE.

Browning Hell's Canyon and Hell's Belles is the go-to clothing for men and women seeking high quality, performance-oriented gear. This versatile lineup includes everything you need to maximize comfort in the field, from base layers to waterproof, insulated parkas and bibs, all designed to keep you warm and dry. A key feature, especially for bowhunters, is **ADVANCED SCENT CONTROL** that helps keep game from picking up human scent. Harness Access hides a safety harness underneath the jacket to maximize safety and concealment in the treestand. Hell's Canyon and Hell's Belles fabrics offer the tough performance the name implies with high resistance to abrasion without sacrificing quietness. Blended down and PrimaLoft® jackets provide an excellent warmth-to-weight ratio when the mercury falls.



WASATCH — VALUE AND PERFORMANCE UNITE.

For quality gear that offers traditional, loose fitting comfort, welcome to Wasatch. Wasatch offers a wide selection of top quality outdoor clothing in styles for men, women and juniors. The designs place function and value over form to provide tough, long lasting gear that will get you comfortably through season after season. Wasatch includes a wide range of clothing to cover every hunting season and situation including insulated, waterproof gear that is ideal for a snowy day in a treestand. Durable soft shells for multi-season use and even shirts and pants of different weights that allow you to match clothing to the temperature.





HEROFIT



HEROFIT

- HeroFit is designed for hunters that take their sport and gear seriously.
- Light and fast is key with HeroFit. Trim dimensions and tough, stretchable fabrics work together to maximize mobility.
- Jacket fit is taken to the extreme with a narrow shoulder line and downward taper from the shoulders to the hips that adds range of motion in the arms and minimizes fabric bunching.
- Trimmer sleeves eliminate excess bulk that can snag on guns or catch bow strings.
- Pants are carefully tailored to maximize range of motion and comfort when walking and high stepping over obstacles.
- Narrower hip and thigh areas reduce bulk and add comfort when sitting for extended periods of time.



ATHLETIC CUT

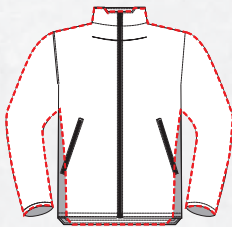

- Athletic Cut provides a trim, tailored fit that reduces bulk, fabric bunching and weight.
- Athletic Cut garments move easily with you and snag less on brush.
- The cut is straight, or slightly tapered, from the shoulders to the hips. If you don't exactly fit this body shape, a larger size can be chosen to maximize mobility and comfort.



REGULAR CUT



- Regular Cut is a traditional, full cut design that offers maximum freedom of movement.
- Regular Cut is tailored for a wide variety of body shapes with a fuller fit. Larger hunters, or those who just want a little extra room, will prefer this fit.



PRE-VENT — SUPERIOR WATERPROOF, WINDPROOF & BREATHABLE FABRICS.

- Pre-Vent is our waterproof, windproof, breathable fabric.
- Pre-Vent keeps out rain, snow and wind while breathing away perspiration to keep you warmer and drier.

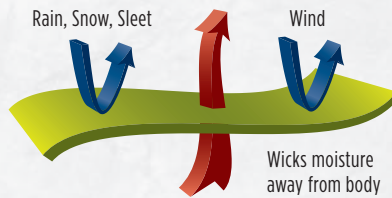

PRIMALOFT® IS WARM, WET OR DRY.

- Primaloft is a premium performance insulation engineered for superior warmth, water-resistance, loft and compressibility.
- Primaloft has the best warmth-to-weight ratio in the industry. The fibers are more densely packed and retain heat better than other insulations for improved thermal efficiency.
- Primaloft fibers are permanently treated to repel water and absorb less water, making it more water-resistant and faster drying than other synthetic insulations.
- Primaloft fibers are tightly compressed for improved wind-resistance, less bulk and extreme compression.
- The fine-fiber, high-loft insulation keeps hunters warmer, in extreme conditions, even if it gets wet.
- Primaloft is so good, it was chosen by the U.S. Military. Over 1,000,000 Primaloft military garments are deployed in active service around the world.

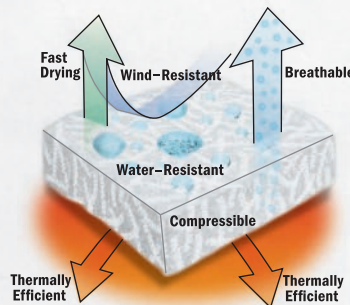

KILL CHILL WITH WINDKILL.

- Our windproof, breathable WindKill fabric is 100% windproof, highly breathable and water resistant.
- A lightweight barrier, WindKill prevents chilling winds from penetrating the fabric to keep you warm.

IMPROVED FOR 2016



AN IMPROVED ADVANTAGE AGAINST HUMAN ODOR.

Outwitting the keen noses of easily spooked game in order to close in on a perfect shot is a challenge every hunter faces. To help you combat human odor, we introduced **ADVANCED SCENT CONTROL** and its two-level protection in 2015. Now it's even more effective. New **ADVANCED SCENT CONTROL POWERED BY AGION ACTIVE XL™** is the next generation of odor management technology and again changes this critical aspect of hunting to put the odds in your favor. New **ADVANCED SCENT CONTROL** captures human scent before it escapes into the air. Dual Technology controls odor causing bacteria on the fabric and captures, traps and degrades odor from sweat for complete protection. **ADVANCED SCENT CONTROL** also regenerates with every wash/dry cycle and lasts for the useful life of the garment. And **ADVANCED SCENT CONTROL POWERED BY AGION ACTIVE XL** does this without adding weight or stiffness.

ADVANCED SCENT CONTROL

- Attacks bacteria that causes human odors.
- Captures and degrades human scent before it escapes into the environment.
- Recharges easily.
- Lasts for the life of the garment.



ODORSMART™

CONTROLS ODOR AT THE START.

- Human odor is caused by bacteria that thrive on the skin. The bacteria's waste produces odors that are detected by deer and other big game animals.
- OdorSmart attacks bacteria in the microclimate around the skin, helping to kill the bacteria before odors develop.
- OdorSmart lasts the life of the garment with normal care, and does not require recharging or special cleansers. You need only to wash OdorSmart items as instructed on the care label.



HARNESS ACCESS ON SELECT HELL'S CANYON OUTERWEAR.

- Select Browning Hell's Canyon outerwear now offers Harness Access.
- Allows a treestand safety harness to be comfortably worn underneath a parka or jacket.
- Improves concealment as the harness no longer interferes with the camouflage pattern on the garment.
- Easy access to pockets.

**A-TACS** CAMO™

ADVANCED TACTICAL CONCEALMENT SYSTEM

We are pleased to have A-TACS
as the proprietary camouflage used on
our new Hell's Canyon gear.



A-TACS CAMOUFLAGE AND THE SCIENCE OF CONCEALMENT.

A-TACS patterns are created utilizing a totally new, patent pending approach to maximize concealment. It starts with a collection of colors taken straight from the outdoors and photographed in carefully controlled lighting. A mathematical algorithm takes the colors and writes "organically-shaped" pixels using the specific color information. The resulting pattern, while still digital is far more organic in appearance than other digital patterns because A-TACS replaces the unnatural angled pixels with organic pixels. The organic pixels are then digitally modified to create real world elements without subscribing to the traditional "limb and leaf" mimicking patterns. The end results are patterns that eliminate the human outline from as close as a few feet and minimizing the "blobbing" effect when viewed from a distance.

Just as nature varies, A-TACS doesn't take a "one-pattern-fits-all" approach. A-TACS camouflage patterns were created to perform in climatic zones containing either arid or timber climates. The arid pattern (AU) is mostly brown with small samplings of green. For temperate, forested climates where green colors dominate, FG (Foliage/Green) is the best choice. These patterns are different not only in color but also in their design. In other words, they are not the same pattern in two different colors, to do so would minimize effectiveness.

We are confident that once you wear A-TACS patterns in the field, you will be a believer in their effectiveness and performance in getting you closer to whatever game you are pursuing.

Put A-TACS and Hell's Canyon Speed to the test.

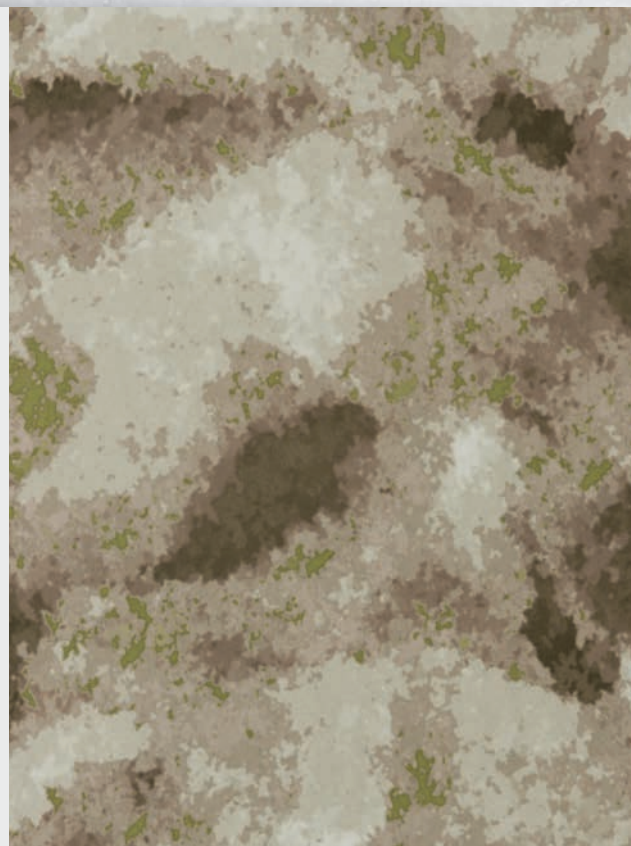

A-TACS AU
CAMO™
ADVANCED TACTICAL CONCEALMENT SYSTEM

A-TACS FG
CAMO™
ADVANCED TACTICAL CONCEALMENT SYSTEM

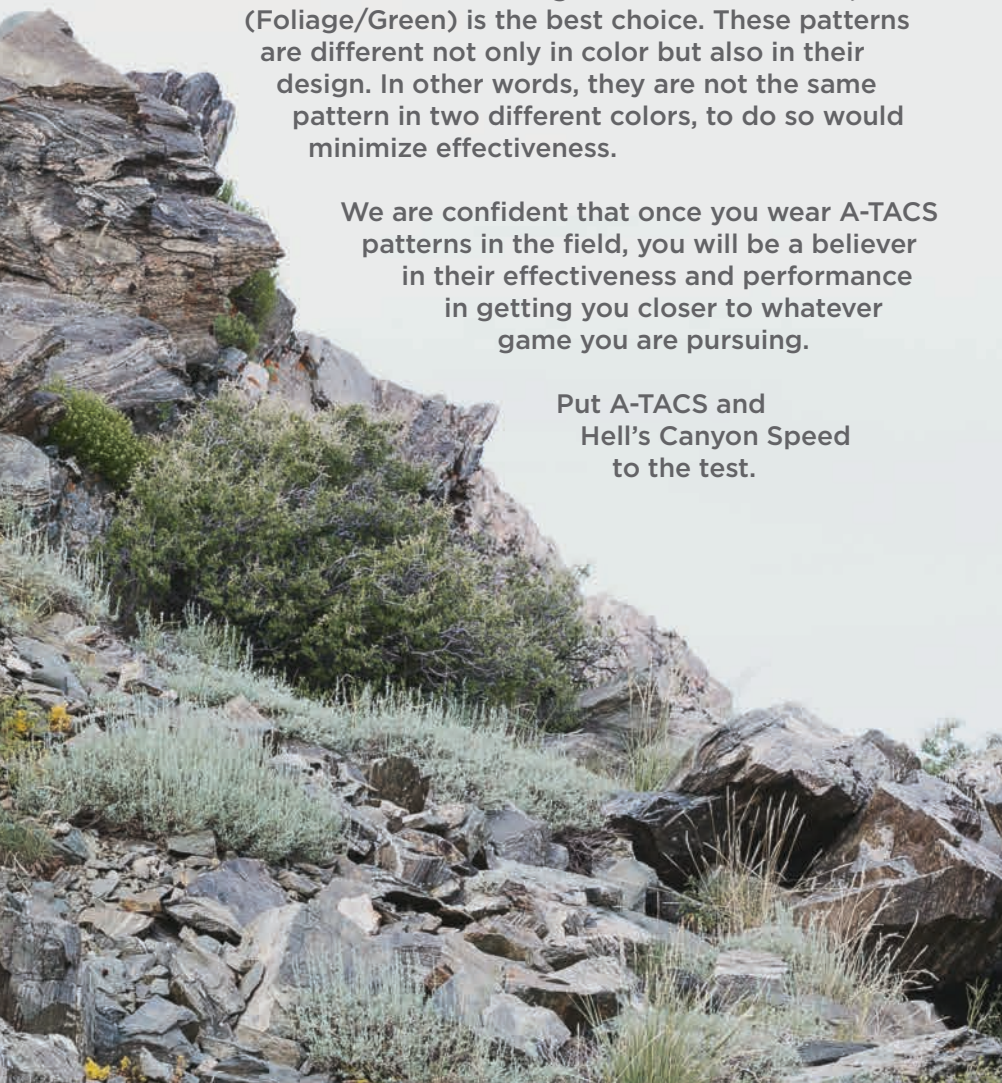
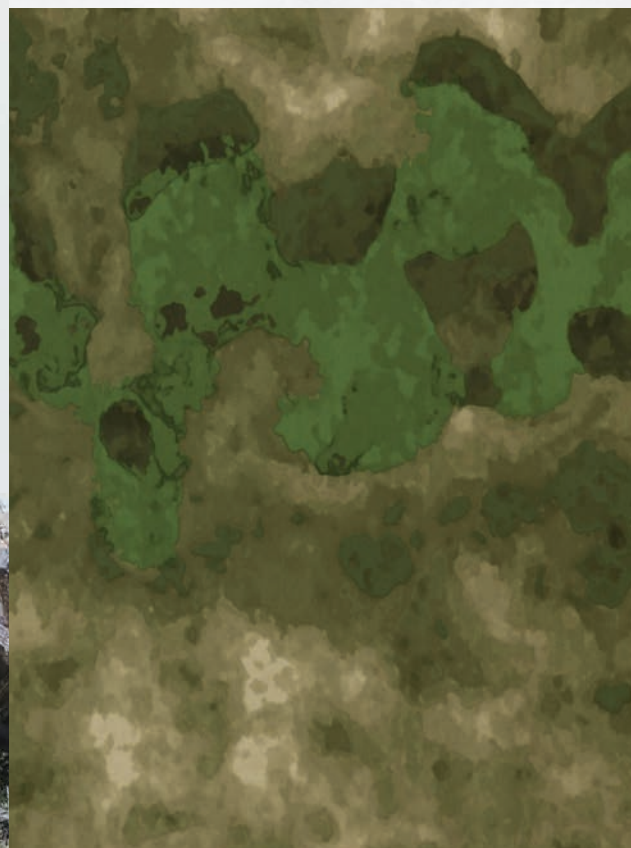



BACKCOUNTRY JACKET

2-Layer soft shell features a stretch woven shell fabric bonded to a soft quiet stretch fleece providing high breathability, and great water and wind resistance • Exclusive A-TACS camo patterns • HeroFit eliminates excess weight and bulk • Handwarmer pockets with zipper closures • One chest pocket with zip closure • Zipper pocket on left sleeve • Harness Access opening on the back allows the jacket to be worn over a treestand safety harness • Bottom hem with drawcord seals in warm air and blocks drafts • Full-length front zipper with internal storm flap and beard guard • Open cuffs

DESCRIPTION	CODE NUMBER	RETAIL	SIZE
(SHOWN IN A-TACS FG)			
A-TACS AU	30482608	199.99	S-3XL
A-TACS FG	30482609		



A-TACS AU



A-TACS FG



BACKCOUNTRY VEST

2-Layer soft shell features a stretch woven shell fabric bonded to a soft quiet stretch fleece providing high breathability, and great water and wind resistance • Exclusive A-TACS camo patterns • HeroFit eliminates excess weight and bulk • Handwarmer pockets with zipper closures • One chest pocket with zip closure • Harness Access opening on the back allows the vest to be worn over a treestand safety harness • Bottom hem with drawcord seals in warm air and blocks drafts • Full-length front zipper with internal storm flap and beard guard

DESCRIPTION	CODE NUMBER	RETAIL	SIZE
(SHOWN IN A-TACS FG)			
A-TACS AU	30582608	169.99	S-3XL
A-TACS FG	30582609		



A-TACS AU

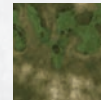

A-TACS FG



BACKCOUNTRY PANT

2-Layer soft shell features a stretch woven shell fabric bonded to a soft quiet stretch fleece providing high breathability, and great water and wind resistance • Exclusive A-TACS camo patterns • HeroFit eliminates excess weight and bulk • Two front hip pockets, two thigh pockets and one rear pocket all with zipper closures • Zipper fly and double snap front closure • Belt loops • Articulated knees and full-length gusset add comfort and mobility

DESCRIPTION	CODE NUMBER	RETAIL	SIZE
(SHOWN IN A-TACS AU)			
A-TACS AU	30282608	189.99	30-44
A-TACS FG	30282609		

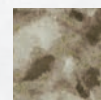

A-TACS AU



A-TACS FG





HELLFIRE JACKET

3-Layer soft shell features a stretch woven outer fabric that is 100% windproof, breathable and water-resistant laminated to a soft, stretchy fleece lining • Exclusive A-TACS camo patterns • HeroFit eliminates excess weight and bulk • Patent pending body mapping Primaloft® insulation in strategic areas throughout the body, sleeves and hood provides maximum performance • Fully adjustable, removable hood • Handwarmer pockets with zipper closures • One chest pocket with zip closure • Harness Access opening on the back allows the jacket to be worn over a treestand safety harness • Bottom hem with drawcord seals in warm air and blocks drafts • Full-length front zipper with internal storm flap and beard guard • Hook and loop adjustable cuffs

DESCRIPTION	CODE NUMBER	RETAIL	SIZE
(SHOWN IN A-TACS AU)			
A-TACS AU	30482708	259.99	S-3XL
A-TACS FG	30482709		



A-TACS AU



A-TACS FG



HELLFIRE PANT

3-Layer soft shell features a stretch woven outer fabric that is 100% windproof, breathable and water-resistant laminated to a soft, stretchy fleece lining • Exclusive A-TACS camo patterns • HeroFit eliminates excess weight and bulk • Patent pending body mapping Primaloft® insulation in strategic areas provides maximum performance • Two front hip pockets, two thigh pockets and one rear pocket all with zipper closures • Zipper fly • Articulated knees and full-length gusset add comfort and mobility

DESCRIPTION	CODE NUMBER	RETAIL	SIZE
(SHOWN IN A-TACS FG)			
A-TACS AU	30282708	249.99	30-44
A-TACS FG	30282709		



A-TACS AU



A-TACS FG





RAIN SLAYER JACKET

3-Layer Pre-Vent soft shell features ultralight shell fabric laminated to featherweight fleece lining that is fully taped to provide the ultimate in lightweight, waterproof, windproof, breathable protection • Exclusive A-TACS camo patterns • Fully adjustable attached hood • Watertight hook and loop cuff closures • Handwarmer pockets with zipper closures • Left side chest pocket with zipper closure • Sized to layer comfortably over clothing • Bottom hem with drawcord seals in warm air and blocks drafts • Full-length front zipper with internal storm flap and beard guard • Underarm pit zips

DESCRIPTION	CODE NUMBER	RETAIL	SIZE
(SHOWN IN A-TACS FG)			
A-TACS AU	30482808	279.99	S-3XL
A-TACS FG	30482809		



A-TACS AU



A-TACS FG



RAIN SLAYER PANT

3-Layer Pre-Vent soft shell features ultralight shell fabric laminated to featherweight fleece lining that is fully taped to provide the ultimate in lightweight, waterproof, windproof, breathable protection • HeroFit eliminates excess weight and bulk • Exclusive A-TACS camo patterns • Two hip pockets and one thigh pocket with zipper closures • Articulated knees and full-length gusset for comfort and mobility • Zip-to-knee cuff zippers for easy on/off • Zipper fly

DESCRIPTION	CODE NUMBER	RETAIL	SIZE
(SHOWN IN A-TACS FG)			
A-TACS AU	30282808	259.99	30-44
A-TACS FG	30282809		



A-TACS AU



A-TACS FG





SHRIKE JACKET

Highly constructed outer shell fabric is wind- and water-resistant • Stitching pattern enhances mobility at elbows and lower body • Exclusive A-TACS camo patterns • HeroFit eliminates excess weight and bulk • Patent pending body mapping PrimaLoft® insulation in strategic areas throughout the body and sleeves provides maximum performance • Handwarmer pockets with zipper closures • One chest pocket with zip closure • Full-length front zipper with internal storm flap and beard guard • Elasticized cuff openings

DESCRIPTION	CODE NUMBER	RETAIL	SIZE
(SHOWN IN A-TACS AU)			
A-TACS AU	30482908	229.99	S-3XL
A-TACS FG	30482909		



A-TACS AU



A-TACS FG



JAVELIN PANT

Rugged, lightweight double-weave shell fabric • HeroFit eliminates excess weight and bulk • Exclusive A-TACS camo patterns • Two hip pockets, two rear pockets and one thigh pocket • Articulated knees and full-length gusset for comfort and mobility • Zipper fly

DESCRIPTION	CODE NUMBER	RETAIL	SIZE
(SHOWN IN A-TACS AU)			
A-TACS AU	30283008	99.99	30-44
A-TACS FG	30283009		



A-TACS AU



A-TACS FG



**TRAILHEAD HOODIE**

250 gram Polyester fleece with brushed inside and smooth outer face • OdorSmart™ antimicrobial technology helps control the bacteria that causes human odors • 1/4 zip with beard guard • Attached hood • Zipper chest pocket • 4-Way stretch • HeroFit eliminates excess weight and bulk

DESCRIPTION	CODE NUMBER	RETAIL	SIZE
(SHOWN IN A-TACS AU)			
A-TACS AU	30182408		
A-TACS FG	30182409	129.99	S-3XL



A-TACS AU

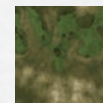

A-TACS FG

**PHASE 1/4 ZIP TOP AND PANT**

220 gram Polyester/Spandex fleece with brushed inside and smooth outer face • Moisture wicking fabric transfers sweat from the body • OdorSmart™ antimicrobial technology helps control the bacteria that causes human odors • Flat lock stitching • 4-Way stretch • HeroFit eliminates excess weight and bulk **SHIRT** 1/4 zip with beard guard • Thumbhole sleeves **PANT** Open fly

DESCRIPTION	CODE NUMBER	RETAIL	SIZE
1/4 ZIP TOP (SHOWN IN A-TACS AU)			
A-TACS AU	30182308		
A-TACS FG	30182309	89.99	S-3XL
PANT (SHOWN IN A-TACS AU)			
A-TACS AU	30282308		
A-TACS FG	30282309	79.99	S-3XL



A-TACS AU

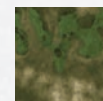

A-TACS FG





PLEXUS MESH SHIRT

Lightweight Polyester technical mesh is ideal as an outer layer in warm weather or layering piece in colder temperatures • Moisture wicking fabric transfers sweat from the body • OdorSmart™ antimicrobial technology helps control the bacteria that causes human odors • Extremely breathable • Crew neck • Flat lock stitching • HeroFit eliminates excess weight and bulk



DESCRIPTION	CODE NUMBER	RETAIL	SIZE
SHORT SLEEVE (SHOWN IN A-TACS AU)			
A-TACS AU	30182008	59.99	S-3XL
A-TACS FG	30182009		
LONG SLEEVE (SHOWN IN A-TACS AU)			
A-TACS AU	30182108	69.99	S-3XL
A-TACS FG	30182109		



A-TACS AU



A-TACS FG



MHS 1/4 ZIP TOP

Main body and under arms are itch-free Merino wool blend to provide superior warmth and extra stretch for added comfort • Top of sleeve and shoulder use the mid-weight fleece fabric for extra warmth • 1/4 zip with beard guard • Thumbhole sleeves • HeroFit eliminates excess weight and bulk

DESCRIPTION	CODE NUMBER	RETAIL	SIZE
(SHOWN IN A-TACS AU)			
A-TACS AU	30108008	99.99	S-3XL
A-TACS FG	30108009		



A-TACS AU



A-TACS FG



MHS BOTTOM AND BRIEF

Main body fabric is itch-free Merino wool blend to provide superior warmth and extra stretch for added comfort • Trim fabric is mid-weight fleece fabric for extra warmth • Elastic waistband • HeroFit eliminates excess weight and bulk

DESCRIPTION	CODE NUMBER	RETAIL	SIZE
BOTTOM (SHOWN IN A-TACS FG)			
A-TACS AU	30208008	89.99	S-3XL
A-TACS FG	30208009		
BRIEF (SHOWN IN A-TACS AU)			
A-TACS AU	30208108	44.99	S-3XL
A-TACS FG	30208109		



A-TACS AU



A-TACS FG



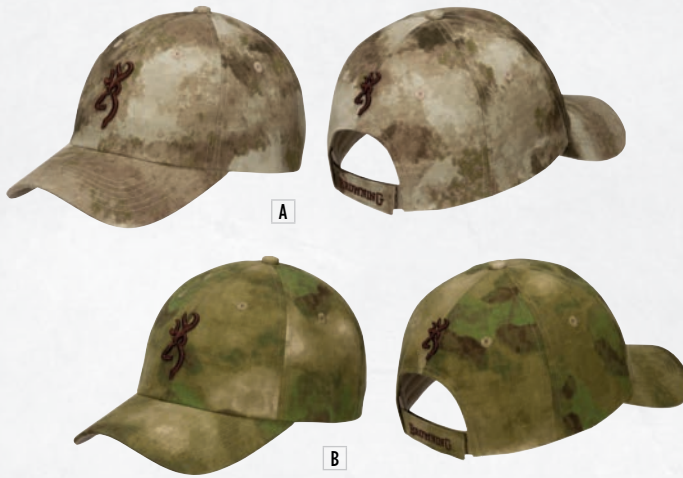

SPEED CAP
CLOSURE Hook and Loop

	DESCRIPTION	CODE NUMBER	RETAIL
A	A-TACS AU	308826081	25.00
B	A-TACS FG	308826091	

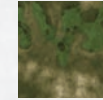
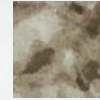

A-TACS AU

A-TACS FG

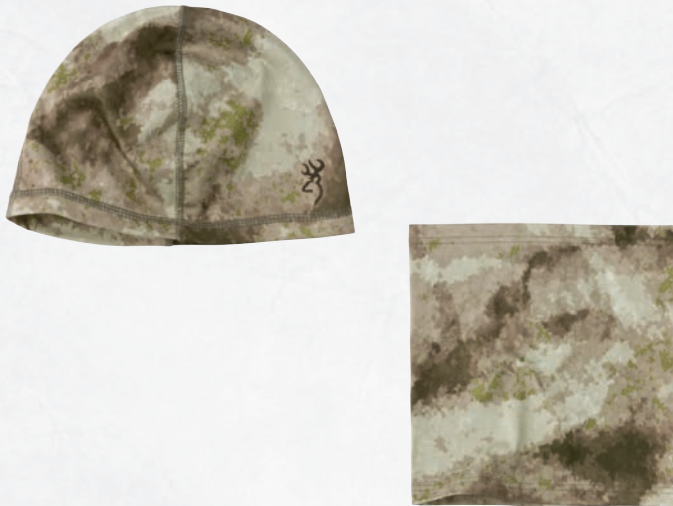

PHASE BEANIE AND NECK GAITER

Mid-weight fleece fabric for extra warmth • Flatlock stitching for added comfort

	DESCRIPTION	CODE NUMBER	RETAIL	SIZE
BEANIE (SHOWN IN A-TACS AU)				
	A-TACS AU	308821081	29.99	One Size Fits Most
	A-TACS FG	308821091		
NECK GAITER (SHOWN IN A-TACS AU)				
	A-TACS AU	308820081	24.99	One Size Fits Most
	A-TACS FG	308820091		



A-TACS AU

A-TACS FG



QUIK-COVER MULTI-FUNCTION HEAD GEAR

Versatile piece can be worn as a beanie, neck gaiter, headband, balaclava and more • Seamless tubular construction helps prevent chafing • Unique fabric makeup helps control human scent • Offers excellent UV protection

	DESCRIPTION	CODE NUMBER	RETAIL	SIZE
	A-TACS AU	308526081	20.00	One Size Fits Most
	A-TACS FG	308526091		

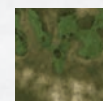

A-TACS AU

A-TACS FG



Versatile piece can be worn as a beanie, neck gaiter, headband, balaclava and more



PHASE LINER GLOVE

Lightweight stretch fabric provides a perfect fit with great dexterity
 • Exclusive A-TACS camo patterns • Tacky surface on palm and fingers makes for a sure grip • Comfortable extended cuffs

DESCRIPTION	CODE NUMBER	RETAIL	SIZE
(SHOWN IN A-TACS AU)			
A-TACS AU	30782308	29.99	M-XL
A-TACS FG	30782309		



A-TACS AU



A-TACS FG



BACKCOUNTRY GLOVE

2-Layer soft shell features a stretch woven shell fabric bonded to a soft quiet stretch fleece providing high breathability, and great water and wind resistance • Exclusive A-TACS camo patterns • Pre-curved fingers provide great dexterity and comfort • Tacky surface on palm and fingers makes for sure grip • Comfortable extended cuffs

DESCRIPTION	CODE NUMBER	RETAIL	SIZE
(SHOWN IN A-TACS AU)			
A-TACS AU	30782608	39.99	M-XL
A-TACS FG	30782609		



A-TACS AU



A-TACS FG



HELLFIRE GLOVE

3-Layer soft shell features a stretch woven outer fabric that is 100% windproof, breathable and water-resistant laminated to a soft, stretchy fleece lining • Exclusive A-TACS camo patterns • Pre-curved fingers provide great dexterity and comfort • Hook and loop cuff closure for snug fit • Palm and fingers feature leather and an extra overlay on the palm and thumb for durability

DESCRIPTION	CODE NUMBER	RETAIL	SIZE
(SHOWN IN A-TACS AU)			
A-TACS AU	30782708	69.99	M-XL
A-TACS FG	30782709		

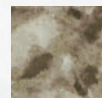

A-TACS AU



A-TACS FG





MATT HUGHES

UFC® Hall of Famer and nine-time welterweight world champion Matt Hughes retired from the Octagon and took a new job in the great outdoors as the host of *Uncaged*. Follow Matt on this exciting show on The Sportsman Channel. Read more about Matt on page 307.







HELL'S CANYON SOFT SHELL

Midweight 3-Layer shell fabric is windproof, water-resistant and breathable • Soft fleece lining features **ADVANCED SCENT CONTROL** Powered by Agion Active XL™ to significantly reduce human scent • Articulated patterning provides comfort and additional freedom of movement • Athletic Cut **JACKET** Harness Access opening on the back allows the jacket to be worn over a treestand safety harness • Stretch nylon adjustable cuffs with hook and loop closures eliminate drafts and prevent water entry • Underarm pit-zips provide ventilation to breathe away perspiration • Sleeves are lined for easy on/off and additional freedom of motion • Two mesh-lined chest pockets with zipper closures • Two mesh-lined handwarmer pockets with zipper closures • External pocket zippers have garages to prevent water entry • Drop-back bottom hem with drawcord seals in warm air and prevents drafts • Corded zipper pulls reduce noise and are easy to grab even with gloves on **PANT** Fully constructed waist with zippered fly, belt loops and no-slip rubberized strip • Hip pockets with reinforced overlay for knife clip • One pocket on each thigh for carrying gear • One rear pocket with zipper closure and storm flap • Side seam ventilation zippers on the hips • Open cuffs with zip-to-knee opening for easy on/off • Articulated knees for comfort



DESCRIPTION	CODE NUMBER	RETAIL	SIZE
JACKET (SHOWN IN MOBUC)			
MOBUC	30458128	179.99	S-XL
		189.99	2XL-3XL
RTX	30458124	179.99	S-XL
		189.99	2XL-3XL
PANT (SHOWN IN MOBUC)			
MOBUC	30258128	169.99	S-XL
		179.99	2XL-3XL
RTX	30258124	169.99	S-XL
		179.99	2XL-3XL

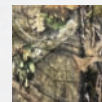

Mossy Oak Break-Up Country

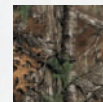

Realtree Xtra



HELL'S BELLES SOFT SHELL

Midweight 3-Layer shell fabric is windproof, water-resistant and breathable • Soft fleece lining features **ADVANCED SCENT CONTROL** Powered by Agion Active XL™ to significantly reduce human scent • Pink camo contrast (Patent Pending) • Women's contoured fit **JACKET** Stretch nylon adjustable cuffs with hook and loop closures eliminate drafts and prevent water entry • Two mesh-lined handwarmer pockets with zipper closures • Zippered pocket on left sleeve • Drop-back bottom hem with drawcord seals in warm air and prevents drafts • Corded zipper pulls reduce noise and are easy to grab even with gloves on **PANT** Fully constructed waist with zippered fly, belt loops and no-slip rubberized strip • Hip pockets • Thigh pocket on right leg carries loads of gear • One rear pocket with zipper closure • Open cuffs with zip-to-knee opening for easy on/off



DESCRIPTION	CODE NUMBER	RETAIL	SIZE
JACKET (SHOWN IN MOBUC)			
MOBUC	30461028	169.99	S-2XL
RTX	30461024		S-2XL
PANT (SHOWN IN MOBUC)			
MOBUC	30261028	159.99	S-2XL
RTX	30261024		S-2XL



Mossy Oak Break-Up Country

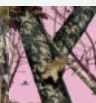

Mossy Oak Pink

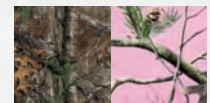

Realtree Xtra Realtree Pink





HELL'S CANYON ULTRA-LITE

Lightweight 2-Layer shell fabric is wind- and water-resistant and highly breathable • Soft fleece lining features **ADVANCED SCENT CONTROL** Powered by Agion Active XL™ to significantly reduce human scent • Articulated patterning provides comfort and additional freedom of movement • Athletic Cut **JACKET** Harness Access opening on the back allows the jacket to be worn over a treestand safety harness • Stretch internal cuffs eliminate drafts • Sleeves are lined for easy on/off and additional freedom of motion • Two oversize pockets with zipper closures and zipper garages prevent water entry • Drop-back bottom hem with drawcord seals in warm air and prevents drafts • Corded zipper pulls reduce noise **PANT** Fully constructed waist with zippered fly, belt loops and no-slip rubberized strip • Hip pockets with reinforced overlays for knife clip • Thigh pockets with zipper closures • One rear pocket with zipper closure • Open cuffs with zip-to-knee opening for easy on/off • Articulated knees for comfort



DESCRIPTION	CODE NUMBER	RETAIL	SIZE
JACKET (SHOWN IN MOBUC)			
MOBUC	30458828	159.99	S-XL
		169.99	2XL-3XL
RTX	30458824	159.99	S-XL
		169.99	2XL-3XL
RTMI	30458823	159.99	S-XL
		169.99	2XL-3XL
PANT (SHOWN IN MOBUC)			
MOBUC	30258828	149.99	S-XL
		159.99	2XL-3XL
RTX	30258824	149.99	S-XL
		159.99	2XL-3XL
RTMI	30258823	149.99	S-XL
		159.99	2XL-3XL

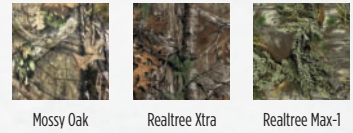

Mossy Oak Break-Up Country

Realtree Xtra

Realtree Max-1



HELL'S BELLES ULTRA-LITE

Lightweight 2-Layer shell fabric is wind- and water-resistant and highly breathable • Soft fleece lining features **ADVANCED SCENT CONTROL** Powered by Agion Active XL™ to significantly reduce human scent • Articulated patterning provides comfort and additional freedom of movement • Pink camo contrast (Patent Pending) • Women's contoured fit **JACKET** Stretch internal cuffs eliminate drafts • Sleeves are lined for easy on/off and additional freedom of motion • Two handwarmer pockets with zipper closures • Drop-back bottom hem with drawcord seals in warm air and prevents drafts • Corded zipper pulls reduce noise **PANT** Elasticized waist with drawcord and belt loops • Two fleece-lined hip pockets • One rear pocket with zipper closure • Open cuffs with zip-to-knee opening for easy on/off



DESCRIPTION	CODE NUMBER	RETAIL	SIZE
JACKET (SHOWN IN MOBUC)			
MOBUC	30468828	149.99	S-2XL
RTX	30468824		S-2XL
PANT (SHOWN IN MOBUC)			
MOBUC	30268828	139.99	S-2XL
RTX	30268824		S-2XL

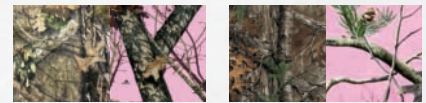

Mossy Oak Break-Up Country

Mossy Oak Pink

Realtree Xtra

Realtree Pink





HELL'S CANYON PRIMALOFT® 4-IN-1 PARKA AND BIB

Quiet Pre-Vent shell fabric is waterproof, windproof and breathable • All seams are taped for 100% waterproof protection • Lightweight, lofty Primaloft® insulation provides unequalled warmth for its weight • All external pocket zippers have garages or pocket flaps to prevent water entry • Articulated patterning for great fit and freedom of movement • Regular Cut **4-IN-1 PARKA** Mesh lining in upper body and taffeta in lower body and sleeves • Detachable hood is fully adjustable for complete protection from the elements • Two large, easily accessible chest pockets with zipper closures • Two large bellows pockets with zipper closures • Handwarmer pockets behind bellows pockets • Internal zippered security pocket for valuables • Underarm gussets provide unrestricted arm movement • Full-length YKK® AquaGuard® front closure with laminated internal zipper flap to prevent water entry • Waist drawcord seals in warm air and prevents drafts • License tab on back doesn't sacrifice waterproofness • Primaloft liner has a highly water- and wind-resistant shell fabric that reverses to solid color **BIB** Lightweight, lofty Primaloft insulation provides unequalled warmth for its weight • Low-front design eliminates bulk when worn with matching parka • Elasticized suspenders and waist allow for a perfect fit and great comfort • Two hip pockets with waterproof zipper closures • One rear zippered pocket • Full-length side seam zippers extend from cuff to thigh for easy on/off • One rear pocket with zipper closure



DESCRIPTION	CODE NUMBER	RETAIL	SIZE
4-IN-1 PARKA (SHOWN IN MOBUC)			
MOBUC	30358628	299.99	S-XL
		329.99	2XL-3XL
RTX	30358624	299.99	S-XL
		329.99	2XL-3XL
BIB (SHOWN IN MOBUC)			
MOBUC	30658628	219.99	S-XL
		229.99	2XL-3XL
RTX	30658624	219.99	S-XL
		229.99	2XL-3XL

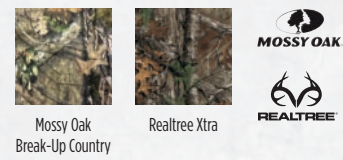

HELL'S CANYON PACKABLE RAIN WEAR

Quiet ultralight Pre-Vent shell fabric is waterproof, windproof and breathable • All seams are taped for 100% waterproof protection • Compresses into provided compact stuff bag • Regular Cut **JACKET** Attached hood is fully adjustable for complete protection from the elements • Elasticized hook and loop adjustable cuffs prevent water entry • Drop-back bottom hem with drawcord seals in warm air and prevents drafts • Upper chest pocket and two handwarmer pockets feature laminated waterproof zippers and zipper garages to prevent water entry • Articulated patterning provides great fit and freedom of movement • License tab on back doesn't sacrifice waterproofness • Full-length YKK® AquaGuard® zippered front closure • Laminated internal storm flap prevents water entry and fleece lined beard guard provides extra comfort **PANT** Elasticized waist with drawcord for easy on/off • Zippered fly • Rear pocket with hook and loop closure • Open cuffs with zip-to-knee opening for easy on/off



DESCRIPTION	CODE NUMBER	RETAIL	SIZE
JACKET (SHOWN IN RTX)			
MOBUC	30458528	189.99	S-XL
		199.99	2XL-3XL
RTX	30458524	189.99	S-XL
		199.99	2XL-3XL
PANT (SHOWN IN RTX)			
MOBUC	30258528	149.99	S-XL
		159.99	2XL-3XL
RTX	30258524	149.99	S-XL
		159.99	2XL-3XL

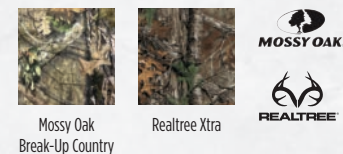

LESS IS MORE.

Down is an incredible insulator with one big drawback — the performance suffers once it gets wet. Synthetic insulations do better with water, but usually can't match up to the warmth of down. By combining warm down with water-resistant synthetic insulation, a dynamic new garment is created, one that will keep you warm in a wider variety of climatic conditions.



HELL'S CANYON BLENDED DOWN JACKET • HELL'S BELLES BLENDED DOWN JACKET

Blended down insulation offers maximum warmth and water-resistance • Highly constructed shell fabric is wind- and water-resistant • Full-length front zipper closure with internal flap to block drafts • Handwarmer pockets with zipper closures • Inside pocket with zipper closure for valuables • Drop back bottom hem and drawcord seals in warm air and keeps out cold • Elasticized cuff closures for added protection from the elements • Stuffs into provided stuff sack for easy storage • Athletic Cut • Hell's Belles has a women's contoured fit



DESCRIPTION	CODE NUMBER	RETAIL	SIZE
JACKET (SHOWN IN MOBUC)			
MOBUC	30473928	169.99	S-XL
		179.99	2XL-3XL
RTX	30473924	169.99	S-XL
		179.99	2XL-3XL
Black	30473990	159.99	S-XL
		169.99	2XL-3XL
HELL'S BELLES JACKET (SHOWN IN MOBUC)			
MOBUC	30461828	159.99	S-2XL
RTX	30461824		S-2XL
Black	30461890	149.99	S-2XL

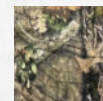

Mossy Oak Break-Up Country

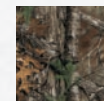

Realtree Xtra



Black



HELL'S CANYON PRIMALOFT® JACKET • HELL'S BELLES PRIMALOFT® JACKET

Featherweight shell fabric is highly water- and wind-resistant • Lightweight Primaloft® insulation throughout assures ultimate lightweight warmth and comfort • Two handwarmer pockets with zipper closures • Inside zippered pocket for valuables • Hell's Canyon has one chest pocket • Drop back bottom hem and drawcord seals in warm air and keeps out cold • Lycra® cuff closures for added protection from the elements • Stuffs into provided stuff sack for easy storage • Full-length front zipper closure with internal flap to block wind and rain • Articulated patterning for great fit and freedom of movement • Athletic Cut • Hell's Belles has a women's contoured fit



DESCRIPTION	CODE NUMBER	RETAIL	SIZE
JACKET (SHOWN IN RTX)			
MOBUC	30458728	159.99	S-XL
		169.99	2XL-3XL
RTX	30458724	159.99	S-XL
		169.99	2XL-3XL
HELL'S BELLES JACKET (SHOWN IN RTX)			
MOBUC	30461228		S-2XL
RTX	30431224	149.99	S-2XL



Mossy Oak Break-Up Country

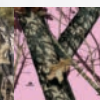

Mossy Oak Pink

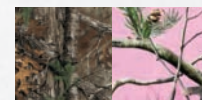

Realtree Xtra

Realtree Pink





PUREHUNTING

WILLI SCHMIDT

Join Willi Schmidt in taking hunting to a new level as he trains, scouts and brings home the trophies in Pure Hunting on The Sportsman Channel. Read more about Willi on page 306.







HELL'S CANYON PERFORMANCE FLEECE 1/4 ZIP JACKET

Warm performance fleece construction • Zippered neck opening for ventilation and easy on/off • Knit cuffs with thumb hole bottom hem block out cold • Zippered chest pocket for valuables • Ideal as a layering or stand alone jacket • Athletic Cut

DESCRIPTION	CODE NUMBER	RETAIL	SIZE
(SHOWN IN RTX)			
MOBUC	30458428	129.99	S-XL
		139.99	2XL-3XL
RTX	30458424	129.99	S-XL
		139.99	2XL-3XL

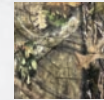

Mossy Oak Break-Up Country

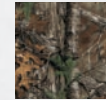

Realtree Xtra



HELL'S CANYON PERFORMANCE FLEECE HOODIE

Warm performance fleece construction • Classic hoodie design with kangaroo pocket and attached hood with drawcord • Knit cuffs with thumb hole bottom hem block out cold • Ideal as a layering or stand alone garment • Athletic Cut

DESCRIPTION	CODE NUMBER	RETAIL	SIZE
(SHOWN IN RTX)			
MOBUC	30158428	129.99	S-XL
		139.99	2XL-3XL
RTX	30158424	129.99	S-XL
		139.99	2XL-3XL

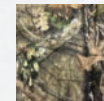

Mossy Oak Break-Up Country

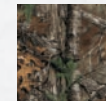

Realtree Xtra



HELL'S CANYON LIGHTWEIGHT BASE LAYER TOP

Lightweight 100% polyester fabric is perfect for both warm weather and layering • OdorSmart™ antimicrobial technology helps control the bacteria that causes human odors • Flatlock stitching for additional comfort • Crew neck • Athletic Cut

DESCRIPTION	CODE NUMBER	RETAIL	SIZE
(SHOWN IN MOBUC)			
MOBUC	30180328	49.99	S-XL
		54.99	2XL-3XL
RTX	30180324	49.99	S-XL
		54.99	2XL-3XL
RTM1	30180323	49.99	S-XL
		54.99	2XL-3XL

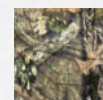

Mossy Oak Break-Up Country

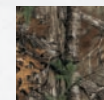

Realtree Xtra

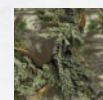

Realtree Max-1





**HELL'S CANYON MIDWEIGHT BASE LAYER
1/4 ZIP TOP AND BOTTOM**

Midweight 100% polyester fabric is ideal for layering in cold conditions • Smooth face with fleece inner layer adds comfort and traps warm air next to the skin for additional warmth • OdorSmart™ antimicrobial technology helps control the bacteria that causes human odors • Flatlock stitching for additional comfort • 1/4 zip collar offers additional ventilation • Fly opening • Elasticized waist • Athletic Cut

DESCRIPTION	CODE NUMBER	RETAIL	SIZE
1/4 ZIP TOP (SHOWN IN MOBUC)			
MOBUC	30180528	49.99	S-XL
		54.99	2XL-3XL
RTX	30180524	49.99	S-XL
		54.99	2XL-3XL
RTM1	30180523	49.99	S-XL
		54.99	2XL-3XL
BOTTOM (SHOWN IN RTM1)			
MOBUC	30215828	39.99	S-XL
		44.99	2XL-3XL
RTX	30215824	39.99	S-XL
		44.99	2XL-3XL
RTM1	30215823	39.99	S-XL
		44.99	2XL-3XL

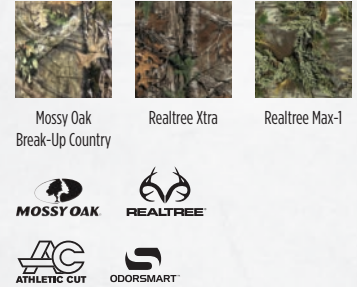

HELL'S CANYON PRE-VENT GLOVE AND HELL'S CANYON GLOVE

PRE-VENT GLOVE Pre-Vent waterproof, breathable shell fabric • PrimaLoft® insulation • Overlay on palm, thumb and fingers • Articulated pre-curved fingers • Elasticized wrist with hook and loop cuff closure for a snug fit
GLOVE Wind- and water-resistant Hell's Canyon fabric throughout • Overlay on palm and thumb for firm grip • Conductive trigger finger works with touch screen electronics • Comfortable fleece cuffs for a snug fit

DESCRIPTION	CODE NUMBER	RETAIL	SIZE
A PRE-VENT GLOVE (SHOWN IN RTX)			
MOBUC	30780328	79.99	M-XL
RTX	30780324		
B GLOVE (SHOWN IN MOBUC)			
MOBUC	30780128	39.99	M-XL
RTX	30780124		

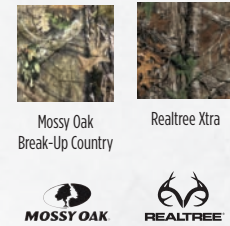

HELL'S CANYON BEANIE

Four-way stretch fabric assures comfortable fit • Warm, comfortable lining • Easily stuffs away into pocket or pack

DESCRIPTION	CODE NUMBER	RETAIL	SIZE
BEANIE (SHOWN IN MOBUC)			
MOBUC	30894128	29.99	One Size Fits Most
RTX	30894124		



NEW CAMO

HELL'S CANYON CLOSURE Hook and Loop Back

NEW 2016	DESCRIPTION	CODE NUMBER	RETAIL
• A	MOBUC	308147281	20.00
B	RTX	308147241	
C	Black	308147991	18.00



WASATCH SOFT SHELL

Quiet, 3-Layer windproof, breathable, water-resistant fabric offers lasting performance **JACKET** Full-length front zipper • Zippered handwarmer pockets • Zippered chest pocket • Raglan sleeve design offers improved freedom of motion • Adjustable cuffs seal out drafts • Stand-up, zip-through collar **PANT** Two front pockets • Two rear zippered pockets • Two zippered cargo pockets • Belt loops • Zippered fly • Regular Cut

DESCRIPTION	CODE NUMBER	RETAIL	SIZE
JACKET (SHOWN IN RTX)			
MOBUC	30414128	79.99	S-XL
		89.99	2XL-3XL
RTX	30414124	79.99	S-XL
		89.99	2XL-3XL
PANT (SHOWN IN RTX)			
MOBUC	30213628	79.99	S-XL
		89.99	2XL-3XL
RTX	30213624	79.99	S-XL
		89.99	2XL-3XL

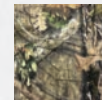

Mossy Oak
Break-Up Country

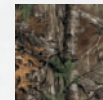

Realtree Xtra



WASATCH FLEECE JACKET

100% midweight polyester fleece is ideal as an insulation layer or outer layer in drier weather • Full-length front zipper • Zippered handwarmer pockets • Lycra® cuffs seal out drafts • Stand-up, zip-through collar • Regular Cut

DESCRIPTION	CODE NUMBER	RETAIL	SIZE
RTX	30413924	59.99	S-XL
		64.99	2XL-3XL

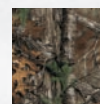

Realtree Xtra





WASATCH INSULATED HOODED JACKET

7 oz. cotton/poly twill shell fabric • Brushed tricot lining
 • Smooth taffeta sleeve lining for easy on/off • SelectWeight™ insulation • Large front pockets with snap closures • Drawcord hood • Rib knit cuffs • Elastic waistband • Regular Cut

DESCRIPTION	CODE NUMBER	RETAIL	SIZE
(SHOWN IN RTX)			
MOBUC	30413728	79.99	S-XL
		89.99	2XL-3XL
RTX	30413724	79.99	S-XL
		89.99	2XL-3XL

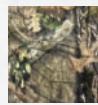

Mossy Oak
Break-Up Country

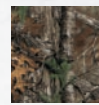

Realtree Xtra



WASATCH MESH-LITE

Cool, comfortable 100% polyester mesh fabric offers excellent ventilation **SHIRTS** Back ventilation panels • Zippered front pockets • Seven-button front • Button down collar
PANT Zippered, angled cargo pockets • Adjustable side tabs • Regular Cut

DESCRIPTION	CODE NUMBER	RETAIL	SIZE
LONG SLEEVE (SHOWN IN RTX)			
MOBUC	30185028	34.99	S-XL
		39.99	2XL-3XL
RTX	30185024	34.99	S-XL
		39.99	2XL-3XL
SHORT SLEEVE (SHOWN IN RTX)			
MOBUC	30185128	29.99	S-XL
		34.99	2XL-3XL
RTX	30185124	29.99	S-XL
		34.99	2XL-3XL
PANT (SHOWN IN RTX)			
MOBUC	30215228	39.99	S-XL
		44.99	2XL-3XL
RTX	30215224	39.99	S-XL
		44.99	2XL-3XL

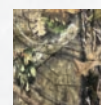

Mossy Oak
Break-Up Country

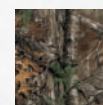

Realtree Xtra





Mossy Oak Shadow
Grass Blades

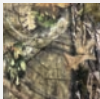

Mossy Oak
Break-Up Country



Mossy Oak
Bottomland

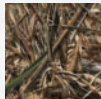

Realtree Max-5

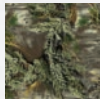

Realtree Max-1

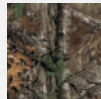

Realtree Xtra



WASATCH SHIRT AND PANT

SHIRT 7 oz., 55% cotton/45% polyester twill fabric

• Seven-button front with long tails • Double pleated back for full range of motion • Button-down collar • Double-needle side seam construction • Adjustable button cuffs and longer sleeve plackets for easier roll-up • Regular Cut

PANT 7 oz., 55% cotton/45% polyester twill • Deep front pockets • Oversized side cargo pockets with flap and button closure • Drawcord cuffs for snug fit around boots

• Adjustable waist tabs for comfortable fit • Rear flap button-through pockets • Regular Cut

DESCRIPTION	CODE NUMBER	RETAIL	SIZE
SHIRT (SHOWN IN MOBUC)			
MOSGB	30113525	29.99	S-XL
		34.99	2XL-3XL
MOBUC	30113528	29.99	S-XL
		34.99	2XL-3XL
MOBL	30113519	29.99	S-XL
		34.99	2XL-3XL
RTM5	30113576	29.99	S-XL
		34.99	2XL-3XL
RTM1	30113523	29.99	S-XL
		34.99	2XL-3XL
RTX	30113524	29.99	S-XL
		34.99	2XL-3XL
PANT (SHOWN IN MOBUC)			
MOSGB	30213525	29.99	S-XL
		34.99	2XL-3XL
MOBUC	30213528	29.99	S-XL
		34.99	2XL-3XL
MOBL	30213519	29.99	S-XL
		34.99	2XL-3XL
RTM5	30213576	29.99	S-XL
		34.99	2XL-3XL
RTM1	30213523	29.99	S-XL
		34.99	2XL-3XL
RTX	30213524	29.99	S-XL
		34.99	2XL-3XL



WASATCH T-SHIRTS

Lightweight, 100% cotton • Loose, comfortable fit

• Crew neck • Regular Cut

DESCRIPTION	CODE NUMBER	RETAIL	SIZE
SHORT SLEEVE (SHOWN IN RTM5)			
RTX	30112524	13.99	S-XL
		16.99	2XL-3XL
RTM5	30112576	13.99	S-XL
		16.99	2XL-3XL
LONG SLEEVE (SHOWN IN RTM5)			
RTX	30112624	16.99	S-XL
		19.99	2XL-3XL
RTM5	30112676	16.99	S-XL
		19.99	2XL-3XL

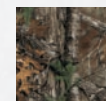

Realtree Xtra

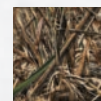

Realtree Max-5





JUNIOR WASATCH

SHIRTS 100% cotton • Loose, comfortable fit • Crew neck
PANT 7 oz., 55% cotton/45% polyester twill
 • Deep front pockets • Oversized side cargo pockets with flap and button closure • Drawcord cuffs for snug fit around boots • Adjustable waist tabs for comfortable fit
 • Rear flap button-through pockets

DESCRIPTION	CODE NUMBER	RETAIL	SIZE
SHORT SLEEVE			
RTX	30113624	11.99	S-XL
LONG SLEEVE			
RTX	30113724	13.99	S-XL
PANT			
RTX	30219024	29.99	S-XL

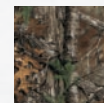

Realtree Xtra



WASATCH FOR HER

SHIRTS 100% cotton • Loose, comfortable fit • Crew neck
PANT 7 oz., 55% cotton/45% polyester twill • Deep front pockets • Oversized side cargo pockets with flap and button closure • Drawcord cuffs for snug fit around boots • Adjustable waist tabs for comfortable fit • Rear flap button-through pockets • Women's contoured fit

DESCRIPTION	CODE NUMBER	RETAIL	SIZE
SHORT SLEEVE			
RTX	30145524	13.99	S-2XL
LONG SLEEVE			
RTX	30145624	16.99	S-2XL
PANT			
RTX	30216424	29.99	S-2XL

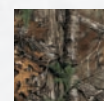

Realtree Xtra





back

front



VAPOR MAX SHORT SLEEVE SHIRT

100% polyester Vapor Max fabric effectively transfers moisture away from your skin • Quick drying • OdorSmart™ antimicrobial technology minimizes human odors • Crew neck • Athletic Cut

DESCRIPTION	CODE NUMBER	RETAIL	SIZE
(SHOWN IN RTX)			
RTX	30188124	27.99	S-XL
		32.99	2XL-3XL
MOBUC	30188103	27.99	S-XL
		32.99	2XL-3XL
RTM1	30188123	27.99	S-XL
		32.99	2XL-3XL
MOSGB	30188125	27.99	S-XL
		32.99	2XL-3XL

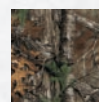

Realtree Xtra

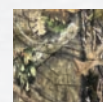

Mossy Oak Break-Up Country

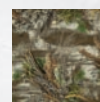

Realtree Max-1

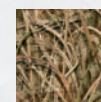

Mossy Oak Shadow Grass Blades



back (RTM1)

front (MOBUC)



VAPOR MAX LONG SLEEVE SHIRT

100% polyester Vapor Max fabric effectively transfers moisture away from your skin • Quick drying • OdorSmart™ antimicrobial technology minimizes human odors • Crew neck • Athletic Cut

DESCRIPTION	CODE NUMBER	RETAIL	SIZE
(SHOWN IN RTM1 AND MOBUC)			
RTX	30188224	32.99	S-XL
		37.99	2XL-3XL
MOBUC	30188203	32.99	S-XL
		37.99	2XL-3XL
RTM1	30188223	32.99	S-XL
		37.99	2XL-3XL
MOSGB	30188225	32.99	S-XL
		37.99	2XL-3XL

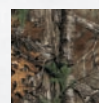

Realtree Xtra

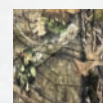

Mossy Oak Break-Up Country

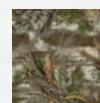

Realtree Max-1

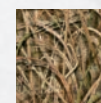

Mossy Oak Shadow Grass Blades





BUCKMARK HOODIE

Midweight cotton/polyester blend • Rib knit cuffs and waist seal in warmth • Drawcord hood • Kangaroo-style handwarmer pocket • Regular Cut

DESCRIPTION	CODE NUMBER	RETAIL	SIZE
(SHOWN IN RTX)			
RTX	30113024	49.99	S-XL
		54.99	2XL-3XL
MOBUC	30113028	49.99	S-XL
		54.99	2XL-3XL

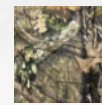
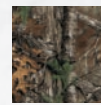

Realtree Xtra

Mossy Oak
Break-Up Country



NEW CAMO



PERFORMANCE II HOODIE

100% polyester fleece • Outer fabric surface is smooth, inner fabric is fleece for additional warmth • Rib knit cuffs seal in warmth • Drawcord hood • Kangaroo-style handwarmer pocket • Appliqué patch logo • Regular Cut

NEW 2016	DESCRIPTION	CODE NUMBER	RETAIL	SIZE
(SHOWN IN RTSNW AND RTX)				
MOBUC	30173828	59.99	S-XL	
		69.99	2XL-3XL	
RTX	30173824	59.99	S-XL	
		69.99	2XL-3XL	
• RTSNW	30173827	59.99	S-XL	
		69.99	2XL-3XL	

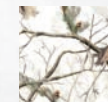
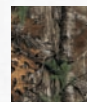
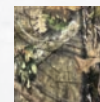

Mossy Oak
Break-Up Country

Realtree Xtra

Realtree Snow



**TWO-TONE II HOODIE**

100% polyester fleece • Outer fabric surface is smooth, inner fabric is fleece for additional warmth • Contrasting solid color panels • Rib knit cuffs seal in warmth • Drawcord hood • Kangaroo-style handwarmer pocket • Appliqué patch logo • Regular Cut

DESCRIPTION	CODE NUMBER	RETAIL	SIZE
(SHOWN IN RTX)			
MOBUC	30173928	59.99	S-XL
		69.99	2XL-3XL
RTX	30173924	59.99	S-XL
		69.99	2XL-3XL

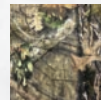

Mossy Oak
Break-Up Country

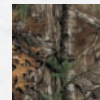

Realtree Xtra

**BLAZE HOODIE**

100% polyester fleece • Outer fabric surface is smooth, inner fabric is fleece for additional warmth • Rib knit cuffs seal in warmth • Kangaroo-style handwarmer pocket • Appliqué patch logo • Regular Cut

DESCRIPTION	CODE NUMBER	RETAIL	SIZE
Blaze/RTX	30175029	49.99	S-XL
		54.99	2XL-3XL



Blaze





NEW CAMO



PERFORMANCE HOODIE FOR HER

100% polyester fleece • Outer fabric surface is smooth, inner fabric is fleece for additional warmth • Rib knit cuffs seal in warmth • Drawcord hood • Kangaroo-style handwarmer pocket • Appliqué patch logo • Regular Cut

NEW 2016	DESCRIPTION	CODE NUMBER	RETAIL	SIZE
(SHOWN IN RTSNW)				
	MOBUC	30174028		
	RTX	30174024	59.99	S-2XL
•	RTSNW	30174027		

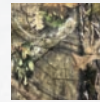

Mossy Oak Break-Up Country

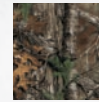

Realtree Xtra



Realtree Snow



NEW 2016



TWO-TONE II HOODIE FOR HER

100% polyester fleece • Outer fabric surface is smooth, inner fabric is fleece for additional warmth • Contrasting solid color panels • Rib knit cuffs seal in warmth • Drawcord hood • Kangaroo-style handwarmer pocket • Appliqué patch logo • Regular Cut

DESCRIPTION	CODE NUMBER	RETAIL	SIZE
(SHOWN IN RTX)			
MOBUC	30174928		
RTX	30174924	59.99	S-2XL

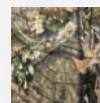

Mossy Oak Break-Up Country

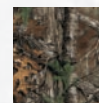

Realtree Xtra







FRED ZINK

Hosted by Fred Zink, *Avian-X* showcases waterfowl and turkey hunts across North America. You can join Fred and his crew on the Pursuit Channel. Read more about Fred on page 307.

WICKED WING — PERFECT FOR WICKED WEATHER.

As if walking through a swamp or laying in a snow covered blind isn't enough, duck hunting often includes soaking rain and freezing cold. Wicked Wing waterfowl gear is built to keep you hunting in comfort regardless of the conditions. Browning professionals have spent countless hours testing and re-testing these Wicked Wing products and the evidence shows with fit and features only real-world experience can produce.

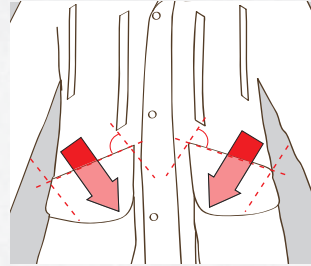
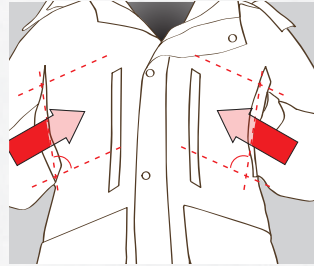
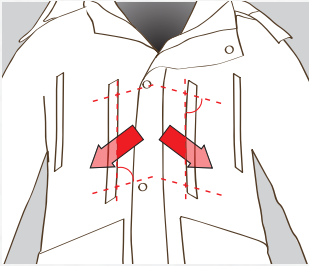
**ANGLE-ENTRY POCKETS**

- Angle-Entry pockets are designed around the arm and hand.
- When the hands are above the elbows they naturally point up, and when they are below the elbows they point down.
- The interiors of the chest accessory Angle-Entry pockets and the shell pockets are slanted down to align with hand angles while the two handwarmer Angle-Entry pockets slant up.

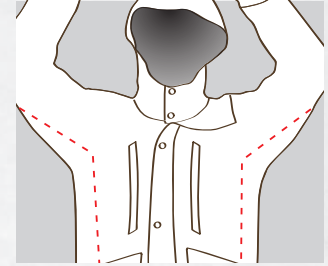
**ARROW GUSSETS**

- The Arrow Gusset armpit design has a smooth, tapering shape as it rises along the side to under the sleeve.
- Offers a better fit, enhanced range of movement and no binding.

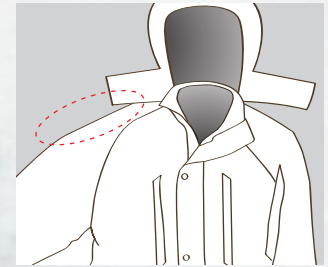
**RAGLAN SLEEVES**

- Raglan sleeves are cut at a long tapering angle right up to the collar line.
- The top of the sleeve becomes one seamless piece of fabric all along the shoulder with no exposed seams to leak, even in the worst downpours.





WICKED WING 4-IN-1 PARKA

SHELL Pre-Vent waterproof, breathable fabric shell • Angle-Entry pocket design • Two upper Angle-Entry handwarmer pockets • Two zippered chest Angle-Entry accessory pockets • Two lower bellows Angle-Entry pockets with magnetic closure and internal pleat • Raglan sleeve design eliminates top shoulder seam for a more waterproof design • Arrow Gusset armpit design and articulated elbow for greater range of motion • Overlay forearm patches to prevent wear • Detachable, adjustable hood • Inside security pocket • External and internal storm flap • Adjustable, watertight laminated cuffs • Molded shoulder strips prevent wear on shoulder areas • Internal waist drawcord • Mesh moisture barrier strip between shell and lining • X-Change System compatible • License tab **LINER** Camo fleece reverses to solid-color woven fabric • PrimaLoft® Synergy insulation • Set-in sleeves • Elasticized bottom and cuffs • Two slash pockets on each side • X-Change System compatible • Regular Cut

DESCRIPTION	CODE NUMBER	RETAIL	SIZE
(SHOWN IN MOSGB)			
MOSGB	30331025	329.99	S-XL
		339.99	2XL-3XL
RTM5	30331076	329.99	S-XL
		339.99	2XL-3XL

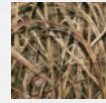

Mossy Oak Shadow Grass Blades

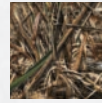

Realtree Max-5



WICKED WING WADER JACKET

Pre-Vent waterproof, breathable fabric shell • PrimaLoft® Synergy insulation maximizes warmth and freedom of movement • Angle-Entry pocket design • Two upper Angle-Entry handwarmer pockets • Two lower bellows Angle-Entry shell pockets with magnetic closure and internal pleat • Raglan sleeve eliminates top shoulder seam for a more waterproof design • Arrow Gusset armpit design and articulated elbow for greater range of motion • Overlay forearm patches to prevent wear • Detachable, adjustable hood • Inside security pocket • Watertight zipper guard • Adjustable, watertight laminated cuffs • Molded shoulder strips prevent wear on shoulder areas • Mesh moisture barrier strip between shell and lining • Shorter wader design with elasticized waist • License tab • Regular Cut

DESCRIPTION	CODE NUMBER	RETAIL	SIZE
(SHOWN IN MOSGB)			
MOSGB	30430225	249.99	S-XL
		259.99	2XL-3XL
RTM5	30430276	249.99	S-XL
		259.99	2XL-3XL

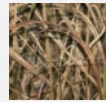

Mossy Oak Shadow Grass Blades



Realtree Max-5



WICKED WING INSULATED BIB

Pre-Vent waterproof, breathable fabric shell • PrimaLoft® Synergy insulation • Overlay protection on seat, knees and inner cuff • Articulated knees for greater range of motion • Full-length, two-way side and front zippers with storm flaps • Rib knit side gussets • Elasticized shoulder straps with cam lock buckles • Two front handwarmer pockets • One zippered chest pocket • Mesh moisture barrier strip between shell and lining • Regular Cut

DESCRIPTION	CODE NUMBER	RETAIL	SIZE
(SHOWN IN RTM5)			
MOSGB	30631225	219.99	S-XL
		229.99	2XL-3XL
RTM5	30631276	219.99	S-XL
		229.99	2XL-3XL

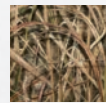

Mossy Oak Shadow Grass Blades

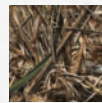

Realtree Max-5



WICKED TIMBER NEEDS WICKED WING.

Wicked Wing Timber is ideal for the unique backdrop of flooded timber. Shorter length jacket styles stay above the waterline to keep the gear in your pockets dry. Soft shells include UTW (Under The Wader) Technology with water-resistant uppers and breathable fleece lowers to keep you from overheating. Fleecees are also designed to wear under waders and have the advantage of splash protection panels on the sleeves to help keep you dry when trudging through the muck.



WICKED WING TIMBER WADER JACKET

Pre-Vent waterproof, breathable fabric shell • Shorter wader length with elastic drawcord waist • Angle-Entry pocket design • Two upper Angle-Entry handwarmer pockets • Two lower bellows shell Angle-Entry pockets with magnetic closure and internal pleat • Raglan sleeve design eliminates top shoulder seam for a more waterproof design • Arrow Gusset armpit design and articulated elbow for greater range of motion • Overlay forearm patches to prevent wear • Detachable, adjustable hood • Inside security pocket • External and internal storm flap • Adjustable, watertight laminated cuffs • Molded shoulder strips prevent wear on shoulder areas • Mesh moisture barrier strip between shell and lining • License tab • Regular Cut

DESCRIPTION	CODE NUMBER	RETAIL	SIZE
(SHOWN IN RTM5)			
MOBL	30433019	229.99	S-XL
		239.99	2XL-3XL
RTM5	30433076	229.99	S-XL
		239.99	2XL-3XL

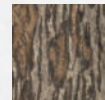

Mossy Oak Bottomland

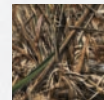

Realtree Max-5



WICKED WING TIMBER RAIN JACKET

Lightweight Pre-Vent shell fabric is 100% waterproof/windproof/breathable • Taped seams prevent water entry • Articulated patterning provides comfort and additional freedom of movement • Attached hood is fully adjustable for complete protection from the elements • Elasticized, hook and loop adjustable cuffs seal out water and wind • Welded chest pocket with laminated zipper closure • Two large handwarmer pockets with laminated zipper closures • All pocket zippers have garages to prevent water entry • Internal storm flap with fleece lined beard guard • Drop-back bottom hem with drawcord seals in warm air and prevents drafts • Corded zipper pulls reduce noise and are easy to grab even with gloves on • License tab • Regular Cut

DESCRIPTION	CODE NUMBER	RETAIL	SIZE
(SHOWN IN MOBL)			
MOBL	30433119	229.99	S-XL
		239.99	2XL-3XL
RTM5	30433176	229.99	S-XL
		239.99	2XL-3XL

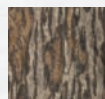

Mossy Oak Bottomland

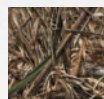

Realtree Max-5





**WICKED WING TIMBER SOFT SHELL
1/4 ZIP TOP AND HOODIE**

UTW Technology provides water-resistant protection on top and breathable fabric on bottom for extra comfort underneath chest waders • 2-Layer wind- and water-resistant fabric on the chest and sleeves provides water and splash protection • Highly breathable smoothbore fleece fabric on the lower half of the body • Lined sleeves for easy on/off • Angle-Entry pocket design • Two upper handwarmer pockets • One zippered chest pocket • One magnetic chest pocket • Lower zippered pockets • Drawcord bottom • 1/4-length zipper • Lycra® binding cuff • Stand-up, zip-through collar • Athletic Cut

DESCRIPTION	CODE NUMBER	RETAIL	SIZE
1/4 ZIP (SHOWN IN MOBL)			
MOBL	30162519	149.99	S-XL
		159.99	2XL-3XL
RTM5	30162576	149.99	S-XL
		159.99	2XL-3XL
HOODIE (SHOWN IN RTM5)			
MOBL	30162619	149.99	S-XL
		159.99	2XL-3XL
RTM5	30162676	149.99	S-XL
		159.99	2XL-3XL



**WICKED WING TIMBER FLEECE
1/4 ZIP TOP AND HOODIE**

Stretchable midweight fleece fabric with Smoothbore outer facing • 2-Layer wind- and water-resistant fabric on the sleeves provides splash protection • Angle-Entry pocket design • Two upper handwarmer pockets • Hoodie has lower kangaroo pocket • Thumbhole cuff design • Welded shoulder pocket with zipper • Lycra® binding waist • Athletic Cut

DESCRIPTION	CODE NUMBER	RETAIL	SIZE
1/4 ZIP (SHOWN IN RTM5)			
MOBL	30162719	139.99	S-XL
		149.99	2XL-3XL
RTM5	30162776	139.99	S-XL
		149.99	2XL-3XL
HOODIE (SHOWN IN MOBL)			
MOBL	30162819	139.99	S-XL
		149.99	2XL-3XL
RTM5	30162876	139.99	S-XL
		149.99	2XL-3XL

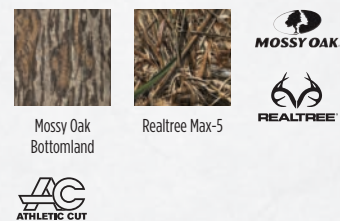



WICKED WING WINDKILL JACKET

3-Layer WindKill fabric blocks wind and prevents water from soaking through • Low-nap fleece inner liner • Lined sleeves for easy on/off • Angle-Entry pocket design • Two upper handwarmer pockets • One zippered pocket • One magnetic chest pocket • Lower zippered pockets • Gusseted shoulder panels for greater range of motion • Mesh lined zip pits • Adjustable, watertight laminated cuffs • Drawcord bottom • Full-length zipper • Stand-up, zip-through collar • Athletic Cut

DESCRIPTION	CODE NUMBER	RETAIL	SIZE
(SHOWN IN RTM5)			
MOSGB	30432625	189.99	S-XL
		199.99	2XL-3XL
RTM5	30432676	189.99	S-XL
		199.99	2XL-3XL

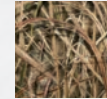

Mossy Oak Shadow Grass Blades

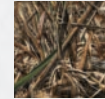

Realtree Max-5



WICKED WING SOFT SHELL PULLOVER

2-Layer wind- and water-resistant fabric • Highly breathable • Low-nap fleece inner liner with lined sleeves for easy on/off • Angle-Entry pocket design • Two upper handwarmer pockets • One zippered chest pocket • One magnetic chest pocket • Lower zippered pockets • Drawcord bottom • 1/4-length zipper • Lycra® binding cuff • Stand-up, zip-through collar • Athletic Cut

DESCRIPTION	CODE NUMBER	RETAIL	SIZE
(SHOWN IN MOSGB)			
MOSGB	30432525	149.99	S-XL
		159.99	2XL-3XL
RTM5	30432576	149.99	S-XL
		159.99	2XL-3XL

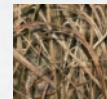

Mossy Oak Shadow Grass Blades

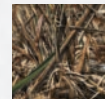

Realtree Max-5



WICKED WING WADER PANT

2-Layer wind- and water-resistant fabric • Single layer fabric below the knee to eliminate bulk in the wader • Hook and loop adjustable tabs on the cuffs tighten around the ankle for sliding into waders • Smooth shell fabric allows waders to slide on/off easy and adds range of motion while wearing with waders • Fully constructed waist with partial elastic waistband • One rear security pocket and two front pockets • Athletic Cut

DESCRIPTION	CODE NUMBER	RETAIL	SIZE
(SHOWN IN MOSGB)			
MOSGB	30232525	99.99	S-XL
		109.99	2XL-3XL
RTM5	30232576	99.99	S-XL
		109.99	2XL-3XL

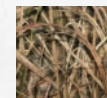

Mossy Oak Shadow Grass Blades

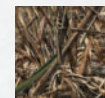

Realtree Max-5





WICKED WING SMOOTHBORE FLEECE 1/4 ZIP TOP

Stretchable midweight fleece fabric with Smoothbore outer facing • Angle-Entry pocket design • Two upper handwarmer pockets • Thumbhole cuff design • 1/4 zip front with stand-up, zip-through collar • Full-length zipper guard and chin protector • Welded shoulder pocket with zipper • Lycra® binding waist and collar • Athletic Cut

DESCRIPTION	CODE NUMBER	RETAIL	SIZE
(SHOWN IN RTM5)			
MOSGB	30161525	139.99	S-XL
		149.99	2XL-3XL
RTM5	30161576	139.99	S-XL
		149.99	2XL-3XL

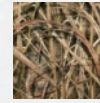

Mossy Oak
Shadow Grass Blades

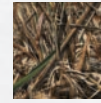

Realtree Max-5



WICKED WING SMOOTHBORE FLEECE HOODIE

Stretchable midweight fleece fabric with Smoothbore outer facing • Angle-Entry pocket design • Two upper handwarmer pockets • Lower kangaroo pockets • Thumbhole cuff design • Attached hood with drawcord • Welded shoulder pocket with zipper • Lycra® binding waist • Athletic Cut

DESCRIPTION	CODE NUMBER	RETAIL	SIZE
(SHOWN IN MOSGB)			
MOSGB	30161625	139.99	S-XL
		149.99	2XL-3XL
RTM5	30161676	139.99	S-XL
		149.99	2XL-3XL

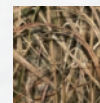

Mossy Oak
Shadow Grass Blades

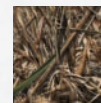

Realtree Max-5



WICKED WING HOODIE

Midweight cotton/polyester blend fabric • Rib knit cuffs and waist seal in warmth • Drawcord hood • Kangaroo-style handwarmer pocket • Regular Cut

DESCRIPTION	CODE NUMBER	RETAIL	SIZE
RTM5	30161776	49.99	S-XL
		54.99	2XL-3XL

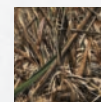

Realtree Max-5





NEW CAMO

WICKED WING INSULATED DECOY GLOVE

Pre-Vent fabric for 100% waterproof protection
 • PrimaLoft® One insulation • Decoy length gauntlet with a unique one-handed cord lock closure • Elasticized wrist for snug fit • Overlay on palm, thumb and fingers for firm grip
 • Articulated fingers with Sensi-Flex trigger finger

NEW 2016	DESCRIPTION	CODE NUMBER	RETAIL	SIZE
(SHOWN IN MOSGB)				
	MOSGB	30730025		
	RTM5	30730076	79.99	M-XL
	• MOBL	30730019		

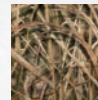

Mossy Oak Shadow Grass Blades

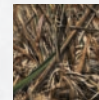

Realtree Max-5

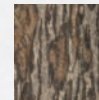

Mossy Oak Bottomland



NEW CAMO

WICKED WING GUNNER'S GLOVE

Pre-Vent fabric for 100% waterproof protection • Elasticized wrist for snug fit • Overlay on palm, thumb and fingers for firm grip • Articulated fingers with Sensi-Flex trigger finger

NEW 2016	DESCRIPTION	CODE NUMBER	RETAIL	SIZE
(SHOWN IN MOSGB)				
	MOSGB	30730125		
	RTM5	30730176	69.99	M-XL
	• MOBL	30730119		



Mossy Oak Shadow Grass Blades



Realtree Max-5



Mossy Oak Bottomland



NEW CAMO

WICKED WING INSULATED GLOVE

Pre-Vent fabric for 100% waterproof protection • PrimaLoft® One insulation • Elasticized wrist for snug fit • Overlay on palm, thumb and fingers for firm grip

NEW 2016	DESCRIPTION	CODE NUMBER	RETAIL	SIZE
(SHOWN IN MOSGB)				
	MOSGB	30730225		
	RTM5	30730276	79.99	M-XL
	• MOBL	30730219		

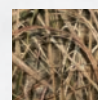

Mossy Oak Shadow Grass Blades

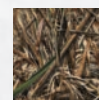

Realtree Max-5

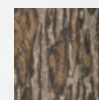

Mossy Oak Bottomland





WICKED WING INSULATED HANDWARMER

3mm neoprene construction • Fleece lined handwarmer compartment with internal handwarmer pockets • 20 shell loops • Dual bellows pockets each hold a box of shells • Zippered valuables pouch • Adjustable nylon belt with buckle fits up to a 60" waist size

DESCRIPTION	CODE NUMBER	RETAIL	SIZE
RTM5	129222	49.99	One Size Fits Most



Realtree Max-5



NEW CAMO

WICKED WING BEANIE

Stretchable midweight fleece fabric with Smoothbore outer facing resists wind • Low-nap fleece lining

NEW 2016	DESCRIPTION	CODE NUMBER	RETAIL	SIZE
(SHOWN IN MOSGB)				
	MOSGB	30837325		
	RTM5	30837376	34.99	One Size Fits Most
	• MOBL	30837319		



Mossy Oak Shadow Grass Blades

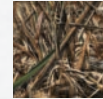

Realtree Max-5

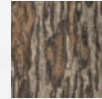

Mossy Oak Bottomland



NEW CAMO

WICKED WING CAP

CLOSURE Hook and Loop

NEW 2016	DESCRIPTION	CODE NUMBER	RETAIL
A	MOSGB	308374251	
B	RTM5	308374761	20.00
• C	MOBL	308374191	

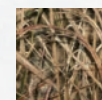

Mossy Oak Shadow Grass Blades

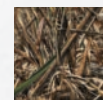

Realtree Max-5

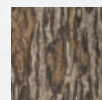

Mossy Oak Bottomland





PHEASANTS
forever



Bob St. Pierre is part of the crew of *Rooster Road Trip*, an online and Facebook promotion for Pheasants Forever. Learn more about Rooster Road Trip and the rest of the team on page 308.



PHEASANTS FOREVER® — JOIN THE GOOD FIGHT.

Without the conservation efforts of Pheasants Forever, millions of acres of prime pheasant habitat would be lost. Pheasants Forever chapters all over the United States work to protect, restore and enhance wildlife habitat by establishing and maintaining local and regional projects. From encouraging farmers to leave longer wheat stubble, to the purchase of upland habitat land, Pheasants Forever continues to work to preserve America's favorite game bird. To become a member or volunteer, please call toll free (877) 773-2070. With every Browning Pheasants Forever product sold, we proudly make a contribution to this most worthy conservation organization.



PHEASANTS FOREVER JACKET

12 oz., 100% cotton canvas • 100% polyester blaze overlay — over 400 square inches
 • Available with Pheasants Forever embroidery • Large bloodproof front load game bag with zip opening for easy cleaning • Shell pockets • Hook and loop pocket flap for easy shell pocket access • D-rings for dog training accessories • Two zippered front pockets • Two-way front zipper with snap storm flap • Adjustable cuffs • REACTAR G2 pad pocket behind each shoulder patch (pad sold separately) • Regular Cut

DESCRIPTION	CODE NUMBER	RETAIL	SIZE
With Embroidery	30411632	119.99	S-XL
		129.99	2XL-3XL
Without Embroidery	30411932	119.99	S-XL
		129.99	2XL-3XL



PHEASANTS FOREVER VEST

12 oz., 100% cotton canvas • Bloodproof game bag with zip opening
 • Available with or without Pheasants Forever embroidery
 • Two zippered front pockets • Zipper front • D-rings for dog training accessories • REACTAR G2 pad pocket behind each shoulder patch (pad sold separately) • Regular Cut

DESCRIPTION	CODE NUMBER	RETAIL	SIZE
With Embroidery	30511632	89.99	S-XL
		99.99	2XL-3XL
Without Embroidery	30511932	89.99	S-XL
		99.99	2XL-3XL



PHEASANTS FOREVER STRAP VEST

Mesh-back game bag with a breathable, bloodproof laminate in the game bag • Shell pockets • Adjustable shoulder straps • Adjustable front belt with speed buckle • Side adjustment straps • Available with or without Pheasants Forever embroidery • Regular Cut

DESCRIPTION	CODE NUMBER	RETAIL	SIZE
With Embroidery	30511732	79.99	One Size
Without Embroidery	30512032		Fits Most



PUSH THROUGH.

Grabby bushes and briars can make a real mess of a pair of jeans and the skin beneath. Upland pants and chaps prevent the barbs from reaching your skin and the smooth surface allows you to slip through heavy cover with ease.



PHEASANTS FOREVER PANT

12 oz., 100% cotton canvas • Briar-resistant overlay • Comfortable, work pant style fit • Deep front pockets • Zipper fly • Flap rear pockets
 • Available with or without Pheasants Forever embroidery • Regular Cut
 • Waist 32"-44" • Inseam lengths 30", 32"

DESCRIPTION	CODE NUMBER	RETAIL
With Embroidery	30211632	69.99
		79.99
Without Embroidery	30211932	69.99
		79.99



PHEASANTS FOREVER CHAPS

12 oz., 100% cotton canvas • Briar-resistant overlay • Double sized adjustment loops with hook and loop closures • Snap side opening for easy on and off • Available with or without Pheasants Forever embroidery
 • Regular Cut • Inseam lengths 28" Regular, 31" Tall

DESCRIPTION	CODE NUMBER	RETAIL
With Embroidery	30011632	69.99
		79.99
Without Embroidery	30011932	69.99
		79.99



MORE COMFORT, GREATER LOAD CAPACITY.

Walking miles with water, lunch, ammunition and, if you are lucky, a couple of birds becomes a real burden if you are using a traditional upland hunting vest. Hunt harder and stay fresh longer with Browning Bird'n Lite gear. Bird'n Lite is essentially a backpack built into an upland hunting vest. Like a backpack, the integrated load-bearing system evenly distributes weight between the shoulders and hips and stabilizes the load to reduce fatigue and increase comfort.



BIRD'N LITE VEST

Browning Bird'n Lite Technology weight distribution system secures the load • Rugged, lightweight cotton/ polyester shell fabric • Blaze shoulder overlays • Front-loading bloodproof game bag with zip-top opening and load stabilizing strap • Oversized shell pockets with internal shell loops and snap closures • Built-in rucksack with elastic top • Zipper front • Transmitter pocket with antenna loop • REACTAR G2 pad pockets behind each quilted shoulder patch (pad sold separately) • Lined handwarmer pockets behind shell pockets • Water bottle pockets • D-rings for accessories • Available with or without Pheasants Forever embroidery • License tab • Regular Cut

DESCRIPTION	CODE NUMBER	RETAIL	SIZE
With Embroidery	30568958	129.99	S-XL
		139.99	2XL-3XL
Without Embroidery	30568858	129.99	S-XL
		139.99	2XL-3XL

Bird'n Lite®



BIRD'N LITE STRAP VEST

Browning Bird'n Lite Technology weight distribution system secures the load • Rugged, lightweight cotton/ polyester shell fabric • Padded blaze shoulder straps • Front-loading bloodproof game bag with load stabilizing strap • Oversized shell pockets with internal shell loops and snap closures • Built-in rucksack with elastic top • Adjustable belt • Lined handwarmer pockets behind shell pockets • Water bottle pockets • Available with or without Pheasants Forever embroidery • Regular Cut

DESCRIPTION	CODE NUMBER	RETAIL	SIZE
With Embroidery	30068958	129.99	M/L
		139.99	XL/ZXL
Without Embroidery	30068858	129.99	M/L
		139.99	XL/ZXL

Bird'n Lite®



- Wide nylon shoulder straps transfer the load to the shoulders, yet still allows you to swing through the bird naturally.
- Quick-release sternum strap helps keep the weight centered between your shoulders for improved balance and less fatigue.
- Fully-adjustable load bearing straps place the load's center of gravity where it's most comfortable to carry.

- Ergonomically-contoured, padded adjustable waist belt offers added support to your lower back and allows part of the load to be carried on your hips for greater comfort.
- Quick-release composite buckle allows for quick on and off.

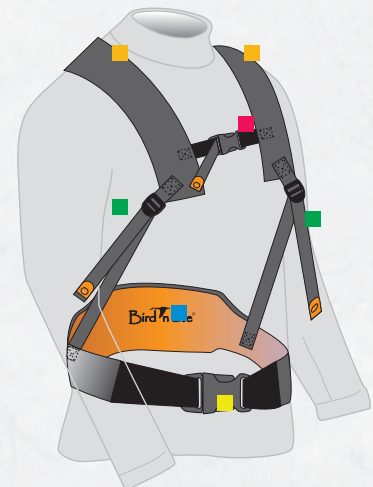



CROSS COUNTRY UPLAND SHIRT

100% polyester fabric moves moisture away from the body • Blaze or loden overlays and shoulder patch • REACTAR G2 pad pocket (pad sold separately) • Angled front pocket • Regular Cut

DESCRIPTION	CODE NUMBER	RETAIL	SIZE
(SHOWN IN KHAKI/LODEN)			
Khaki/Loden	30119340	49.99	S-XL
		54.99	2XL-3XL
Khaki/Blaze	30119358	49.99	S-XL
		54.99	2XL-3XL



Khaki Loden



Khaki Blaze



PRAIRIELANDS UPLAND SHIRT

100% cotton canvas • Contrasting sleeve and shoulder • Pleated action back for comfort and mobility • Chest pocket • REACTAR G2 pad pocket (pad sold separately) • Padded shoulder patch • Longer sleeve placket for easy roll-up • Button-down collar • Regular Cut

DESCRIPTION	CODE NUMBER	RETAIL	SIZE
Desert/Forest	30113764	49.99	S-XL
		54.99	2XL-3XL



Desert Forest



NTS UPLAND SHIRT

Moisture moving 100% polyester fabric is perfect for hot weather bird hunting • Two-tone design • Athletic Cut

DESCRIPTION	CODE NUMBER	RETAIL	SIZE
Khaki/Blaze	30118201	39.99	S-XL
		44.99	2XL-3XL



Khaki Blaze



TAKE A BREATHER.

Hunting in the heat and humidity of late summer and early fall will sap the energy out of you. When shade is scarce, drink plenty of water and wear a lightweight Browning vest. Our vests make good use of breathable mesh and lightweight fabrics to help keep you cool and ready when the shooting heats up.



UPLAND GAME VEST

100% poly oxford • Front load bloodproof game bag • Elasticized shell loops • Large bellows pockets • Mesh sides and back for light weight and increased ventilation • Regular Cut

DESCRIPTION	CODE NUMBER	RETAIL	SIZE
RTX	30517024	49.99	S-XL
		54.99	2XL-3XL

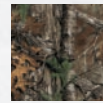

Realtree Xtra



Khaki



UPLAND DOVE VEST

7 oz. 55%/45% cotton/poly twill fabric • Lightweight, comfortable design is ideal for hot weather • Mesh front and back panels provide greater breathability • Two bellows shell pockets • Bloodproof rear game bag • Zippered front • Regular Cut

DESCRIPTION	CODE NUMBER	RETAIL	SIZE
RTX	30510324	29.99	S-XL
		34.99	2XL-3XL

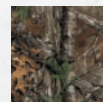

Realtree Xtra



Olive



BELTED DOVE GAME BAG

100% poly oxford fabric • Web belt with adjustable buckle • Two large shell pockets with accessory pockets for choke tubes, glasses and other small items • Large bloodproof game bag with mesh sides for ventilation • Pockets slide on belt for easy positioning • Snap closures • Regular Cut

DESCRIPTION	CODE NUMBER	RETAIL	SIZE
RTX	30910624	29.99	One Size Fits Most

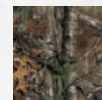

Realtree Xtra



SAFETY COMES FIRST.

The safety orange vest is usually a necessary hunting requirement. Don't skimp on a cheap vest, pick up a functional vest that is built to last and features large pockets for gear and ammo.



SAFETY VEST

100% polyester oxford • Zip front • Back license loop • Large snap flap shell pockets • Buckmark embroidery on front and back • Regular Cut

DESCRIPTION	CODE NUMBER	RETAIL	SIZE
Blaze	30510001	16.99	S-3XL



Blaze



JUNIOR SAFETY VEST

100% polyester oxford • Zip front • Back license loop • Large snap flap shell pockets • Buckmark embroidery on front and back

SIZES S (6-8), M (10-12), L (14-16), XL (18-20)

DESCRIPTION	CODE NUMBER	RETAIL	SIZE
Blaze	30550001	14.99	S-XL



Blaze

**TEAM BROWNING SHOOTING VEST**

Full-length suede shooting patch • 100% cotton body construction
 • Mesh sides for ventilation • Two-way front zipper • Four large front shell pockets • Bar tacks at all stress points • Side tab adjustments • Sewn-in REACTAR G2 pad pocket (pad sold separately) • Split shoulder for ease of movement • Chest pocket • D-rings for towel

DESCRIPTION	CODE NUMBER	RETAIL	RIGHT/LEFT	SIZE
Black/Gold	30515499	64.99	Right-Hand	S-3XL

**REACTAR G2**

Black

Gold

**TEAM BROWNING SHOOTING POLO SHIRTS**

100% polyester knit fabric with moisture wicking properties • Lightweight breathable material keeps you comfortable in hot and humid weather
 • Long lasting sublimated printed design

DESCRIPTION	CODE NUMBER	RETAIL	RIGHT/LEFT	SIZE
Black/Gold/Gray	30105569	64.99	Right-Hand	S-3XL

**REACTAR G2**

Black

Gold

Gray

**TEAM BROWNING GLOVE**

Durable 4-way stretch hard face fleece shell fabric provides lightweight warmth • Flat seamed palm and back of hand for added comfort and durability • Silicone imprint on palm and fingertips improves grip • Washable

DESCRIPTION	CODE NUMBER	RETAIL	SIZE
Black/Gold	30701599	34.99	S-2XL



Black

Gold



SANTA FE PRO SHOOTING VEST

Crazy Horse Leather full-length shooting patch and trim • Cotton twill and polyester mesh body for ventilation • Two-way front zipper • Four large front shell pockets • Bar tacks at all stress points • Back tab adjustments • Large back pocket for empties or other gear • Sewn-in REACTAR G2 pad system • Elastic choke tube loops • Split shoulder for ease of movement • 100% polyester mesh • Interior security pocket

DESCRIPTION	CODE NUMBER	RETAIL	RIGHT/LEFT	SIZE
Sage/Oak	30504154	189.99	Right-Hand	S-2XL

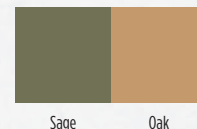

MASTER-LITE LEATHER PATCH VEST

Full-length leather shooting patch • 100% cotton body construction • Mesh sides for ventilation • Two-way front zipper • Four large front shell pockets • Bar tacks at all stress points • Side tab adjustments • Sewn-in REACTAR G2 pad system • Split shoulder for ease of movement • Chest pocket • Towel loop

DESCRIPTION	CODE NUMBER	RETAIL	RIGHT/LEFT	SIZE
Black/Orange	30503099	179.99	Right-Hand	S-3XL

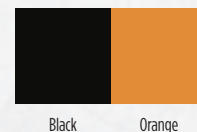

DELUXE MESH SHOOTING VEST

Twill full-length shooting patch • Mesh body for ventilation • Two-way front zipper • Four large front shell pockets • Bar tacks at all stress points • Side tab adjustments • Large back pocket for empties or other gear • Sewn-in REACTAR G2 pad system • Split shoulder for ease of movement • 60% cotton/40% poly twill • 100% polyester mesh

DESCRIPTION	CODE NUMBER	RETAIL	RIGHT/LEFT	SIZE
Black/Tan	30501799	119.99	Right-Hand	S-3XL
Black/Tan	30502799		Left-Hand	M-2XL

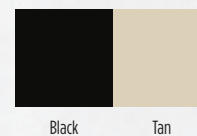



RHETT SHOOTING VEST

Full-length 100% cotton garment-washed shooting patches on right and left shoulders with sewn-in REACTAR G2 pad pockets (pad sold separately) • 100% polyester mesh body for ventilation • Choke tube loops • Two-way front zipper • Bellows shell pockets • Side tab adjustments • Large back pocket for empties or other gear • Inside security pocket

	DESCRIPTION	CODE NUMBER	RETAIL	RIGHT/LEFT	SIZE
A	Olive/Tan	30502974	54.99	Ambidextrous	S-3XL
B	Charcoal/Tan	30502979			

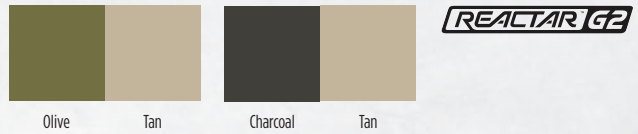

NEW COLOR



SUMMIT SHOOTING VEST

Durable polyester shooting patches on right and left shoulders with sewn-in REACTAR G2 pad pockets (pad sold separately) • 100% polyester mesh body for ventilation • Two-way front zipper • Bellows shell pockets • Side tab adjustments • Large back pocket for empties or other gear

NEW 2016	DESCRIPTION	CODE NUMBER	RETAIL	RIGHT/LEFT	SIZE
A	Tan/Chocolate/Taupe	30503168	64.99	Ambidextrous	S-3XL
B	White/Black/Charcoal	30503199			
C	Tan/Green/Dark Gray	30503184			



NEW 2016



ACE SHOOTING VEST

Smooth nylon full-length shooting patch • Polyester/Spandex construction • Two-way front zipper • Bellows shell pockets • Choke tube and valuables pockets • Large back pocket for empties or other gear • Room on back panel to embroider shooting team/school name • Side tab adjustments • Sewn-in REACTAR G2 pad pocket (pad sold separately)

	DESCRIPTION	CODE NUMBER	RETAIL	RIGHT/LEFT	SIZE
A	Black/Gray/Blue	30508265	64.99	Right-Hand	XS-2XL
B	Black/Gray/Neon Yellow	30508205			

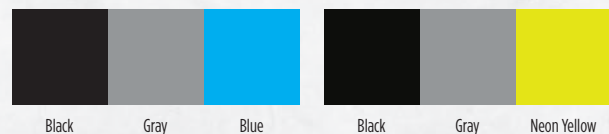



A

TRAPPER CREEK MESH SHOOTING VEST

100% poly mesh body for ventilation • Full-length 100% garment washed cotton twill shooting patch • Internal REACTAR G2 pad pocket (pad sold separately) • Four large shell pockets • Bar tacks at stress points • Side tab adjustments • Large rear pocket for hulls and other gear

	DESCRIPTION	CODE NUMBER	RETAIL	RIGHT/LEFT	SIZE
A	RTX/Brown	30502624	54.99	Right-Hand	S-3XL
B	Black/Tan	30502689	49.99	Right-Hand	S-3XL
	Black/Tan	30503689		Left-Hand	M-2XL
C	Sage/Black	30502654	49.99	Right-Hand	S-3XL
D	Clay/Black	30502668		Right-Hand	S-3XL
E	Sand/Black	30502628		Right-Hand	S-3XL
	Sand/Black	30503628		Left-Hand	M-2XL



B



C



D



E



Realtree Xtra

Brown

Black

Tan

Sage

Black

Clay

Black

Sand

Black



A

TRAPPER CREEK MESH HALF VEST

Adjustable polyester web belt with speed buckle • Double, oversized shell pockets • Mesh shell pouch with zip bottom for easy emptying

	DESCRIPTION	CODE NUMBER	RETAIL	SIZE
A	Sage/Black	30900754	39.99	One Size Fits Most
B	Black/Black	30900798		



B



Sage

Black

Black/Black



A



B



C

NEW COLOR

SUMMIT SHOOTING VEST FOR HER

Durable polyester shooting patches on right and left shoulders with sewn-in REACTAR G2 pad pockets (pad sold separately) • 100% polyester mesh body for ventilation • Two-way front zipper • Bellows shell pockets • Side tab adjustments • Large back pocket for empties or other gear • Women's contoured fit

NEW 2016	DESCRIPTION	CODE NUMBER	RETAIL	RIGHT/LEFT	SIZE
A	Cream/Plum/Dark Gray	30507191	64.99	Ambidextrous	S-2XL
B	Tan/Brown/Cinnamon	30507188			
C	Cream/Fuchsia/Smoke	30507194			

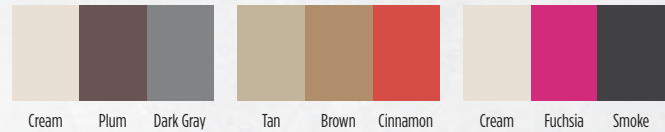

REACTAR G2



A



B



C

SPORTER II SHOOTING VEST FOR HER

Twill full-length shooting patch • Mesh body for ventilation • Two-way front zipper • Two large front shell pockets • Bar tacks at all stress points • Side tab adjustments • Large back pocket for empties or other gear • Sewn-in REACTAR G2 pad system (pad sold separately) • Split shoulder for ease of movement • 60% cotton/40% poly twill • 100% polyester mesh • Women's contoured fit

	DESCRIPTION	CODE NUMBER	RETAIL	RIGHT/LEFT	SIZE
A	Sage/Tan/Pink	30506754	64.99	Ambidextrous	S-2XL
B	Brown/Pink/Tan	30506788			
C	Sage/Tan/RTAPP	30506726			

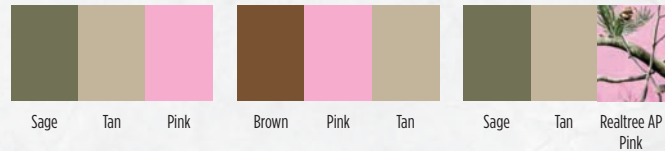

REACTAR G2



A



B

NEW 2016

ACE SHOOTING VEST FOR HER

Smooth nylon full-length shooting patch • Polyester/Spandex construction • Two-way front zipper • Bellows shell pockets • Choke tube and valuables pockets • Large back pocket for empties or other gear • Room on back panel to embroider shooting team/school name • Side tab adjustments • Sewn-in REACTAR G2 pad pocket (pad sold separately) • Women's contoured fit

	DESCRIPTION	CODE NUMBER	RETAIL	RIGHT/LEFT	SIZE
A	Black/Gray/Hot Pink	30507277	64.99	Right-Hand	XS-2XL
B	Black/Gray/Purple	30507296			

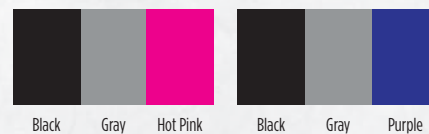

REACTAR G2

COOL COMFORT FOR THE WHOLE FAMILY.

We offer stylish, comfortable shooting vests tailored for every member of the family. Constructed from high quality materials, our shooting vests are built to last.



A



B



JUNIOR TRAPPER CREEK SHOOTING VEST

100% poly mesh body for ventilation • Full-length 100% garment washed cotton twill shooting patch • Internal REACTAR G2 pad pocket (pad sold separately) • Two-way front zipper • Large shell pockets • Side tab adjustments • Large back pocket for empties or other gear • Inside security pocket • Buckmark and Claymaster embroidery
SIZES S (6-8), M (10-12), L (14-16), XL (18-20), 2XL (22)

	DESCRIPTION	CODE NUMBER	RETAIL	RIGHT/LEFT	SIZE
A	Sage/Black	30505454	44.99	Ambidextrous	S-2XL
B	Black/Tan	30505489			

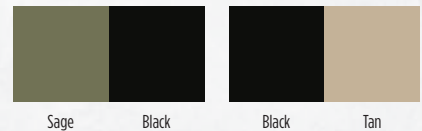

NEW COLOR



A



B



JUNIOR TRAPPER CREEK SHOOTING VEST FOR HER

100% poly mesh body for ventilation • Full-length 100% garment washed cotton twill shooting patch • Internal REACTAR G2 pad pocket (pad sold separately) • Two-way front zipper • Large shell pockets • Side tab adjustments • Large back pocket for empties or other gear • Inside security pocket • Buckmark and Claymaster embroidery
SIZES S (6-8), M (10-12), L (14-16), XL (18-20), 2XL (22)

NEW 2016	DESCRIPTION	CODE NUMBER	RETAIL	RIGHT/LEFT	SIZE
• A	Brown/Pink/Tan	30505488	44.99	Ambidextrous	S-2XL
B	Sage/Tan/Pink	30505444			

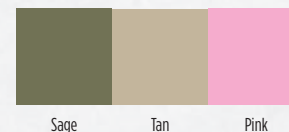
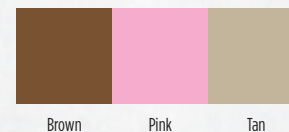



DURA-LITE SHOOTING GLOVE

Durable yet sensitive digital goatskin leather palm and fingers for enhanced grip
 • Supple Cabretta sheepskin leather on fingers and thumb for added dexterity
 • Perforated vents keep hands cool and comfortable • Stretchy and breathable
 Lycra® inserts at knuckle articulation points • Adjustable hook and loop closure

DESCRIPTION	CODE NUMBER	RETAIL	SIZE
Black	30701699	59.99	S-2XL

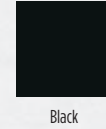

Black



MESH BACK SHOOTING GLOVE

Lightweight, soft brushed synthetic suede • Stretch mesh back for comfortable fit and enhanced air circulation • Hook and loop closure tab allows for adjustable, comfortable fit • Claymaster embroidery • Washable

	DESCRIPTION	CODE NUMBER	RETAIL	SIZE
A	Tan/Black	30701188	29.99	S-2XL
B	Black	30701190		



Tan

Black

Black



**TRAPPER CREEK SHOOTING GLOVE
 TRAPPER CREEK SHOOTING GLOVE FOR HER**

Lightweight, soft brushed synthetic suede • Stretch mesh back for comfortable fit and enhanced air circulation • Comfortable pull-on style • Washable

	DESCRIPTION	CODE NUMBER	RETAIL	SIZE
A	Charcoal/Black	30701379	34.99	S-2XL
B	White/Fuchsia	30701447		



Charcoal

Black

White

Fuchsia



SHOOTING TOWEL

100% cotton construction • Sturdy eyelet with clip attaches to shooting vest
 • Tri-fold design is compact and unobtrusive • Buckmark embroidery

	DESCRIPTION	CODE NUMBER	RETAIL	SIZE
A	Black/Gold	309009991	15.00	13x22
B	Black/Pink	309009992		



Black

Gold

Black

Pink



A



B

REACTAR G2 PAD • REACTAR G2 PAD AND HARNESS

PAD Exclusive REACTAR G2 pad (REcoil ACTION ARrestor) absorbs recoil on the inside of vest, jacket or shirt without altering appearance or increasing length of pull • Uses patented, environmentally-friendly Impact Gel™ to reduce peak recoil • Only 8mm thick • Lightweight • Flexible to form to the body • Dimensions: 3-3/4" W x 7" L **PAD AND HARNESS** Includes REACTAR G2 pad • Heavy-duty 500 denier Cordura® • Reversible for use by right- or left-handed shooters • Elastic strap with buckle size adjustment

	CODE NUMBER	RETAIL	SIZE
A	REACTAR G2 PAD		
	309013	24.99	One Size Fits Most
B	REACTAR G2 PAD AND HARNESS		
	309011	49.99	One Size Fits Most



A



BRIDGER SHOOTING JACKET

Warm wool body • Polyester shooting patch and contrasting overlays • Stand-up, zip-through collar • Zipper handwarmer pockets • Zipper pocket on left arm and chest • Sewn-in REACTAR G2 pad pocket (pad sold separately) • Athletic Cut

	DESCRIPTION	CODE NUMBER	RETAIL	SIZE
A	Lodden/Brown	30408064	139.99 144.99	S-XL 2XL-3XL
B	Black/Gray	30408099	139.99 144.99	S-XL 2XL-3XL



B

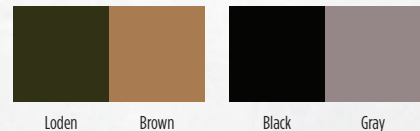



NEW 2016

AUSTIN SHOOTING SHIRTS

100% lightweight woven cotton canvas • Pleated back for greater mobility • Snap button front
 • Left chest pocket • Quilted shooting patch • Internal REACTAR G2 pad pocket (pad sold separately)
 • Athletic Cut

DESCRIPTION	CODE NUMBER	RETAIL	SIZE
SHORT SLEEVE (SHOWN IN TAUPE/LODEN)			
Taupe/Loden	30106578	44.99	S-XL
		49.99	2XL-3XL
Loden/Taupe	30106564	44.99	S-XL
		49.99	2XL-3XL
LONG SLEEVE (SHOWN IN LODEN/TAUPE)			
Taupe/Loden	30106678	49.99	S-XL
		54.99	2XL-3XL
Loden/Taupe	30106664	49.99	S-XL
		54.99	2XL-3XL



NEW 2016

PHENIX SHOOTING SHIRTS

100% polyester woven jaquard fabric is lightweight and breathable • Vented back
 • Zippered pocket on right chest, hook and loop closure pocket on left chest
 • Athletic Cut

DESCRIPTION	CODE NUMBER	RETAIL	SIZE
SHORT SLEEVE (SHOWN IN KHAKI)			
Khaki	30107658	49.99	S-XL
		54.99	2XL-3XL
Dark Olive	30107664	49.99	S-XL
		54.99	2XL-3XL
LONG SLEEVE (SHOWN IN KHAKI)			
Khaki	30107758	54.99	S-XL
		59.99	2XL-3XL
Dark Olive	30107764	54.99	S-XL
		59.99	2XL-3XL

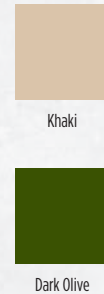

HIGHLINE TECH SHIRTS

Moisture wicking 73% polyester, 22% rayon, 5% spandex blend fabric
 • Comfortable and stretches to provide superb freedom of movement
 • Internal REACTAR G2 pad pocket (pad sold separately) **POLO** Three-button front placket • Polo collar **1/4 ZIP** 1/4 zip front placket • Stand-up collar
 • Athletic Cut

DESCRIPTION	CODE NUMBER	RETAIL	SIZE
POLO SHIRT (SHOWN IN GRAY)			
Heather	30107069	49.99	S-XL
		54.99	2XL-3XL
Coffee	30107088	49.99	S-XL
		54.99	2XL-3XL
Gray	30107079	49.99	S-XL
		54.99	2XL-3XL
1/4 ZIP SHIRT (SHOWN IN COFFEE)			
Heather	30107169	54.99	S-XL
		59.99	2XL-3XL
Coffee	30107188	54.99	S-XL
		59.99	2XL-3XL
Gray	30107179	54.99	S-XL
		59.99	2XL-3XL

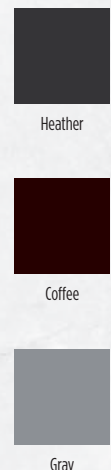



BLACK LABEL TACTICAL SHIRTS

Lightweight cotton/spandex fabric • Seven-button front placket • SnapShot hidden magnetic center buttons for fast access to shoulder holster or security credentials • Internal REACTAR G2 pad pockets (pad not included) • Vented back • Hidden collar stays • Two front-load pockets • Two pleated chest pockets • Elbow overlays on long sleeve models • Regular Cut

DESCRIPTION	CODE NUMBER	RETAIL	SIZE
SHORT SLEEVE (SHOWN IN SAND)			
Black	30138499	39.99	S-XL
		44.99	2XL-3XL
Sand	30138448	39.99	S-XL
		44.99	2XL-3XL
Forest	30138494	39.99	S-XL
		44.99	2XL-3XL
LONG SLEEVE (SHOWN IN FOREST)			
Black	30138599	49.99	S-XL
		54.99	2XL-3XL
Sand	30138548	49.99	S-XL
		54.99	2XL-3XL
Forest	30138594	49.99	S-XL
		54.99	2XL-3XL

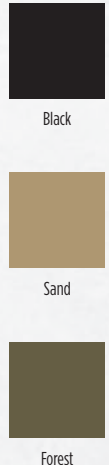

BLACK LABEL PERFORMANCE POLO SHIRT

Wrinkle-resistant polyester knit fabric with moisture wicking properties • Sewn self-fabric collar • Vented back • Internal REACTAR G2 pad pockets (pad not included) • ConcealAccess split sides with hook and loop closure • Lower placket microphone clip loop • Pen pockets on left sleeve • Welded patch pocket on right sleeve • Regular Cut

DESCRIPTION	CODE NUMBER	RETAIL	SIZE
(SHOWN IN FOREST)			
Black	30138299	39.99	S-XL
		44.99	2XL-3XL
Sand	30138248	39.99	S-XL
		44.99	2XL-3XL
Forest	30138294	39.99	S-XL
		44.99	2XL-3XL

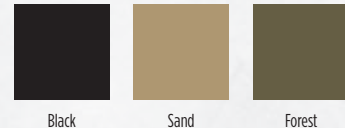

BLACK LABEL TACTICAL PRO PANT

Lightweight poly/cotton ripstop fabric • Partial elasticized waistband • Heavy-duty belt loops • Gusseted crotch • Internal knee pad pockets (pads not included) • Two accessory side pockets • Two rear pockets • Pocket flaps for added security • Knife clip overlay on front pockets • Internal cuff guard • Regular Cut **WAIST SIZES 32", 34", 36", 38", 40", 42", 44"** **INSEAM LENGTHS 32", 34"**

DESCRIPTION	CODE NUMBER	RETAIL	SIZE
(SHOWN IN SAND)			
Black	30238199	59.99	32, 34, 36, 38
		64.99	40, 42, 44
Sand	30238148	59.99	32, 34, 36, 38
		64.99	40, 42, 44

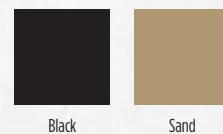



BLACK LABEL

BLACK LABEL TEAM TECH T-SHIRT

100% polyester knit fabric with moisture wicking properties
 • Lightweight breathable material keeps you comfortable in hot and humid weather • Long lasting sublimated printed design
 • Regular Cut

DESCRIPTION	CODE NUMBER	RETAIL	SIZE
Gray/Black	30138899	79.99	S-XL
		84.99	2XL-3XL



Gray Black



BLACK LABEL PERFORMANCE T-SHIRTS

Polyester knit fabric with moisture wicking properties • Comfortable crew neck • Ideal for wear with duty uniform, body armor or web gear
 • Regular Cut

DESCRIPTION	CODE NUMBER	RETAIL	SIZE
SHORT SLEEVE			
Black	30138099	29.99	S-XL
		34.99	2XL-3XL
LONG SLEEVE			
Black	30138199	39.99	S-XL
		44.99	2XL-3XL



Black



BLACK LABEL TACTICAL PERFORMANCE HOODIE

100% polyester knit fabric • Smooth outer surface with contrasting color panels • Soft fleece interior surface • Self cuffs • ConcealAccess split sides • Roomy drawcord hood • Regular Cut

DESCRIPTION	CODE NUMBER	RETAIL	SIZE
Black/Steel	30138999	49.99	S-XL
		54.99	2XL-3XL



Black Steel





BLACK LABEL FIREPOWER FLEECE JACKET

Midweight polyester fleece • ConcealAccess split sides with non-locking zippers • Two side slash pockets • Internal REACTAR G2 pad pockets (pad not included) • Lined sleeves for easy on/off • Lycra® cuffs and sleeve pocket • Regular Cut

DESCRIPTION	CODE NUMBER	RETAIL	SIZE
Forest	30438394	139.99	S-XL
		149.99	2XL-3XL

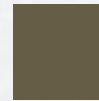

Forest



BLACK LABEL TRACER SOFT SHELL JACKET

2-Layer soft shell fabric is highly breathable • One chest concealed carry pocket • ConcealAccess split sides with non-locking zippers • Two side slash pockets with hidden internal zippered pocket • Internal REACTAR G2 pad pockets (pad not included) • Lycra® cuffs and welded sleeve pocket with zipper • Regular Cut

DESCRIPTION	CODE NUMBER	RETAIL	SIZE
Forest/Desert	30438294	149.99	S-XL
		159.99	2XL-3XL



Forest

Desert



BLACK LABEL FMJ WINDKILL JACKET

3-Layer WindKill fabric • Upper body faced in ripstop fabric • Two chest concealed carry pockets • ConcealAccess split sides with non-locking zippers • Armpit zippers • Two side slash pockets • Adjustable cuffs • Internal REACTAR G2 pad pockets (pad not included) • Welded sleeve pocket • Regular Cut

DESCRIPTION	CODE NUMBER	RETAIL	SIZE
(SHOWN IN BLACK/GRAY)			
Black/Gray	30438179	169.99	S-XL
		179.99	2XL-3XL
Forest/Desert	30438194	169.99	S-XL
		179.99	2XL-3XL



Black

Gray



Forest

Desert





ROCKWELL
CLOSURE Flexfit

	DESCRIPTION	CODE NUMBER	RETAIL
A	Black S/M	308709992	25.00
	Black L/XL	308709994	
B	Heather S/M	308709492	
	Heather L/XL	308709494	



TARTAN
CLOSURE Flexfit

DESCRIPTION	CODE NUMBER	RETAIL
Black Plaid S/M	308708992	25.00
Black Plaid L/XL	308708994	

DYLAN
CLOSURE Flexfit

DESCRIPTION	CODE NUMBER	RETAIL
Black/Khaki S/M	308706582	25.00
Black/Khaki L/XL	308706584	

FLASHBACK
CLOSURE Flexfit

DESCRIPTION	CODE NUMBER	RETAIL
Bubble Camo S/M	308704292	25.00
Bubble Camo L/XL	308704294	



CORONADO
CLOSURE Flexfit

DESCRIPTION	CODE NUMBER	RETAIL
Black S/M	308007992	25.00
Black L/XL	308007994	

DOUGLAS
CLOSURE Flexfit

DESCRIPTION	CODE NUMBER	RETAIL
Olive Plaid S/M	308705842	25.00
Olive Plaid L/XL	308705844	

STALKER
CLOSURE Flex



DESCRIPTION	CODE NUMBER	RETAIL
Camo S/M	308178342	25.00
Camo L/XL	308178344	



COLSTRIP
CLOSURE Flexfit

	DESCRIPTION	CODE NUMBER	RETAIL
A	Charcoal S/M	308702892	25.00
	Charcoal L/XL	308702894	
B	Dark Brown S/M	308702982	
	Dark Brown L/XL	308702984	



PORTER
CLOSURE Flex

	DESCRIPTION	CODE NUMBER	RETAIL
A	Black S/M	308711992	25.00
	Black L/XL	308711994	
B	Gray S/M	308711792	
	Gray L/XL	308711794	
C	Sage S/M	308711542	
	Sage L/XL	308711544	

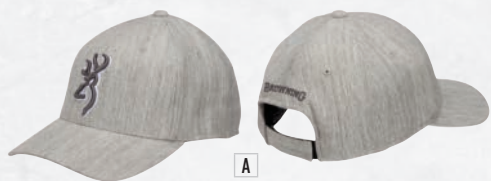

A



B

110
CLOSURE Hook and Loop



	DESCRIPTION	CODE NUMBER	RETAIL
A	Heather	308190691	25.00
B	Charcoal	308190791	



A



B



FLASHBACK NEON
CLOSURE Snap



	DESCRIPTION	CODE NUMBER	RETAIL
A	Charcoal/Neon Green	308177541	18.00
B	Charcoal/Neon Orange	308177621	

CODY
CLOSURE Hook and Loop



	DESCRIPTION	CODE NUMBER	RETAIL
	Brown/Orange	308187881	18.00



A



B



C



DENIM
CLOSURE Hook and Loop

	DESCRIPTION	CODE NUMBER	RETAIL
A	Green	308180941	18.00
B	Red	308180711	
C	Orange	308180621	



A



B

CACHE
CLOSURE Snap



	DESCRIPTION	CODE NUMBER	RETAIL
A	Black/Gray	308181991	18.00
B	Sage/Brown	308181541	



A



B



C



OVER/UNDER
CLOSURE Hook and Loop

	DESCRIPTION	CODE NUMBER	RETAIL
A	Olive	308248841	18.00
B	Brown	308248881	
C	Black	308248991	

Realtree Xtra® Camo on underside of brim



**NEW
COLOR**



RHINO
CLOSURE Hook and Loop

NEW 2016	DESCRIPTION	CODE NUMBER	RETAIL
A	Brown	308378881	18.00
• B	Gray	308378791	



**NEW
2016**

GRUNGE
CLOSURE Snap

	DESCRIPTION	CODE NUMBER	RETAIL
A	Black	308188991	20.00
B	Brown	308188881	
C	Stone	308188481	



BOZEMAN
CLOSURE Hook and Loop

	DESCRIPTION	CODE NUMBER	RETAIL
A	Black	308357991	18.00
B	Brown	308357981	
C	Olive	308357841	
D	Orange	308357721	



STACK-LITE
CLOSURE Hook and Loop

	DESCRIPTION	CODE NUMBER	RETAIL
A	White	308290471	18.00
B	Charcoal	308290891	
C	Black	308290991	



STRAW WITH REPEL-TEX BRIM
CLOSURE Hook and Loop

DESCRIPTION	CODE NUMBER	RETAIL
Straw/Brown	308106881	28.00



BECKER
CLOSURE Hook and Loop

DESCRIPTION	CODE NUMBER	RETAIL
Brown	308251881	20.00



A



B



C



LEGACY
CLOSURE Hook and Loop

	DESCRIPTION	CODE NUMBER	RETAIL
A	Navy	308186951	20.00
B	Brown	308186881	
C	Pebble	308186491	

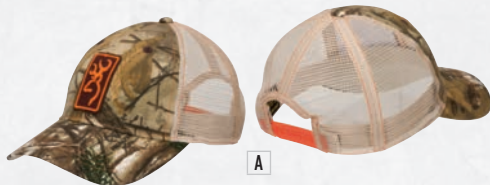

A



B



CONWAY
CLOSURE Snap



	DESCRIPTION	CODE NUMBER	RETAIL
A	RTX/Orange	308175721	18.00
B	RTX/Lime	308175541	



A



B

LOGAN
CLOSURE Slide Buckle



	DESCRIPTION	CODE NUMBER	RETAIL
A	Brown/Orange	308296881	20.00
B	White/Black	308296471	



A



B

BOONE
CLOSURE Hook and Loop



	DESCRIPTION	CODE NUMBER	RETAIL
A	Gray/Black	308149791	20.00
B	Black/Gray	308149991	
C	Brown/Khaki	308149881	



C



BIG BUCKMARK TWO-TONE
CLOSURE Hook and Loop

DESCRIPTION	CODE NUMBER	RETAIL
Black/Gray	308014991	20.00



TWO-TONE WAX
CLOSURE Hook and Loop



DESCRIPTION	CODE NUMBER	RETAIL
Dark Brown/Brown	308192981	25.00



A



B

DURA-WAX WITH CORPORATE LOGO
CLOSURE Hook and Loop

	DESCRIPTION	CODE NUMBER	RETAIL
A	Olive	308412381	25.00
B	Brown	3084121	



LIBERTY WAX
CLOSURE Hook and Loop

DESCRIPTION	CODE NUMBER	RETAIL
Dark Brown	308776881	25.00



DURA-WAX WITH 3D BUCKMARK
CLOSURE Hook and Loop

DESCRIPTION	CODE NUMBER	RETAIL
Brown	308412881	25.00



LITE WAX WITH CORPORATE LOGO
CLOSURE Hook and Loop

DESCRIPTION	CODE NUMBER	RETAIL
Khaki	308412581	25.00



REPEL-TEX CLOTH TWO-TONE WITH 3D BUCKMARK
CLOSURE Hook and Loop

DESCRIPTION	CODE NUMBER	RETAIL
Acorn/Olive	308110341	22.00



A



B



BIG BUCKMARK AND CAMO
CLOSURE Hook and Loop

	DESCRIPTION	CODE NUMBER	RETAIL
NEW 2016			
A	RTX	308204241	20.00
B	MOBUC	308204031	





STRUTTER
CLOSURE Hook and Loop

NEW 2016



DESCRIPTION	CODE NUMBER	RETAIL
RTXG	308173241	22.00



DIGI-CAMO DESERT
CLOSURE Hook and Loop

DESCRIPTION	CODE NUMBER	RETAIL
Digi Camo	308506291	18.00



RIMFIRE
CLOSURE Hook and Loop

	DESCRIPTION	CODE NUMBER	RETAIL
A	MOBL	308379191	20.00
B	MOSGB	308379251	
C	MOBUC	308379281	
D	RTM5	308379761	
E	RTM1	308379231	
F	RTX	308379241	
G	RTSNW	308379271	



NEW 2016

BOZEMAN BROWN MESH
CLOSURE Hook and Loop



	DESCRIPTION	CODE NUMBER	RETAIL
A	RTX	308367241	20.00
B	RTM5	308367761	
C	RTM1	308367231	
D	MOBUC	308367281	
E	MOSGB	308367251	
F	MOBL	308367191	



FLASHBACK MESH
CLOSURE Snap

DESCRIPTION	CODE NUMBER	RETAIL
Bubble Camo	308174421	23.00



MESH-LITE
CLOSURE Hook and Loop



DESCRIPTION	CODE NUMBER	RETAIL
RTX	308160211	20.00

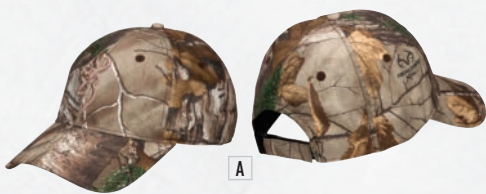

A



B



C



D



TRAIL-LITE
CLOSURE Hook and Loop

	DESCRIPTION	CODE NUMBER	RETAIL
A	RTX	308150241	25.00
B	RTM5	308150761	
C	MOBUC	308150281	
D	MOSGB	308150251	



A



B



C



CO-BRANDED
CLOSURE Hook and Loop

	DESCRIPTION	CODE NUMBER	RETAIL
A	RTX	308720241	18.00
B	RTX/MESH	308720881	
C	BLACK	308720991	



A



B



SPEED
CLOSURE Hook and Loop

	DESCRIPTION	CODE NUMBER	RETAIL
A	A-TACS AU	308826081	20.00
B	A-TACS FG	308826091	





BLAZE CAMO
CLOSURE Snap 

DESCRIPTION	CODE NUMBER	RETAIL
Blaze Camo	308381291	20.00



SAFETY WITH 3D BUCKMARK
CLOSURE Hook and Loop

DESCRIPTION	CODE NUMBER	RETAIL
Blaze/Black	30840501	18.00



SAFETY PHEASANTS FOREVER EMBROIDERY
CLOSURE Hook and Loop



DESCRIPTION	CODE NUMBER	RETAIL
Blaze	308126011	18.00



SURE SHOT
CLOSURE Hook and Loop

DESCRIPTION	CODE NUMBER	RETAIL
Blaze	308380011	18.00



HI-VIZ BLAZE
CLOSURE Hook and Loop

DESCRIPTION	CODE NUMBER	RETAIL
Blaze	308461591	18.00



FLEXFIT SAFETY
CLOSURE Flexfit

DESCRIPTION	CODE NUMBER	RETAIL
Blaze S/M	308707722	25.00
Blaze L/XL	308707724	



YOUTH BLAZE
CLOSURE Hook and Loop

DESCRIPTION	CODE NUMBER	RETAIL
Blaze	30850101Y	16.00



BRAVO FLEXFIT TWILL
CLOSURE Flexfit

DESCRIPTION	CODE NUMBER	RETAIL
Gray S/M	308551892	25.00
Gray L/XL	308551894	



DUTY
CLOSURE Hook and Loop

DESCRIPTION	CODE NUMBER	RETAIL
Digi Camo	308555291	18.00



A



B

ROGUE
CLOSURE Hook and Loop

	DESCRIPTION	CODE NUMBER	RETAIL
A	Black	308558991	20.00
B	Sand	308558481	
C	Olive Drab	308558841	
D	Desert Brown	308558681	



C



D



SHIELD
CLOSURE Snap

DESCRIPTION	CODE NUMBER	RETAIL
Black	308556991	23.00



A



CHELSEIE
CLOSURE Hook and Loop

	DESCRIPTION	CODE NUMBER	RETAIL
A	Black/Pink	308244511	20.00
B	Black/Purple	308244461	



B



GEENA
CLOSURE Hook and Loop

DESCRIPTION	CODE NUMBER	RETAIL
Olive/Magenta	308255841	25.00



NADIA
CLOSURE Hook and Loop

DESCRIPTION	CODE NUMBER	RETAIL
Gray/White	308246691	25.00



JEWELLED MESH BACK FOR HER
CLOSURE Hook and Loop

DESCRIPTION	CODE NUMBER	RETAIL
Brown	308355881	18.00



SWEETHEART MESH
CLOSURE Hook and Loop

DESCRIPTION	CODE NUMBER	RETAIL
Black/Hot Pink	308239992	20.00



FLASHBACK NEON 
CLOSURE Snap

DESCRIPTION	CODE NUMBER	RETAIL
Charcoal/Neon	308177771	18.00



DURA WAX W/CORPORATE LOGO FOR HER
CLOSURE Hook and Loop

DESCRIPTION	CODE NUMBER	RETAIL
Brown/Pink	308412511	23.00



DIVA
CLOSURE Slide Buckle

DESCRIPTION	CODE NUMBER	RETAIL
Black/Fuchsia	308363991	20.00



TIVA 
CLOSURE Snap

DESCRIPTION	CODE NUMBER	RETAIL
Fuchsia/Black	308192771	18.00



HEARTBREAKER
CLOSURE Snap 

DESCRIPTION	CODE NUMBER	RETAIL
Navy/Pink	308193951	18.00



PIXIE
CLOSURE Hook and Loop 

DESCRIPTION	CODE NUMBER	RETAIL
Pink	308194511	20.00



HEATHER
CLOSURE Hook and Loop 

DESCRIPTION	CODE NUMBER	RETAIL
Gray/Pink	308195691	24.00



FAUX
CLOSURE Hook and Loop 

DESCRIPTION	CODE NUMBER	RETAIL
Brown/Fuchsia	308184121	20.00



DIGBY
CLOSURE Snap 

DESCRIPTION	CODE NUMBER	RETAIL
Pink/Camo	308161411	18.00



NEW CAMO

3D BUCKMARK FOR HER
CLOSURE Hook and Loop

NEW 2016	DESCRIPTION	CODE NUMBER	RETAIL
A	RTX/Fuchsia	308179242	18.00
B	MOBUC/Fuchsia	308179281	



GUNNER FOR HER
CLOSURE Hook and Loop



DESCRIPTION	CODE NUMBER	RETAIL
MOINF/Pink	308129202	24.00



BIG BUCKMARK AND CAMO FOR HER
CLOSURE Hook and Loop



DESCRIPTION	CODE NUMBER	RETAIL
RTX/Fuchsia	308204771	20.00



SWEETHEART CAMO

CLOSURE Hook and Loop



DESCRIPTION	CODE NUMBER	RETAIL
RTX/Hot Pink	308239242	22.00



COUNTRY

CLOSURE Hook and Loop



DESCRIPTION	CODE NUMBER	RETAIL
RTX/Pink	308183241	20.00



SIERRA

CLOSURE Hook and Loop



DESCRIPTION	CODE NUMBER	RETAIL
Olive/RTX	308153841	20.00



JEWELLED WITH CAMO

CLOSURE Hook and Loop



DESCRIPTION	CODE NUMBER	RETAIL
RTX/Brown	308355241	18.00



CONWAY

CLOSURE Snap



DESCRIPTION	CODE NUMBER	RETAIL
RTM1/Pink	308175231	18.00



FLURRY

CLOSURE Hook and Loop



DESCRIPTION	CODE NUMBER	RETAIL
RTSNW	308185271	20.00



RIMFIRE FOR HER

CLOSURE Hook and Loop



DESCRIPTION	CODE NUMBER	RETAIL
RTAPP	308379261	18.00



BLAZE BEAUTY

CLOSURE Slide Buckle



DESCRIPTION	CODE NUMBER	RETAIL
Blaze	308196011	22.00

DISCOVER THE BROWNING CUSTOM CAP COLLECTION

This is your chance to create your own unique Browning Buckmark cap using your favorite color scheme. Visit your local Authorized Browning Dealer and design custom caps for your family reunion, shooting team or hunting club and stand out from the crowd. You can also create special caps that show your loyalty to your local college or pro sports team. Have fun!

RETAIL
25.00



CAP COLOR

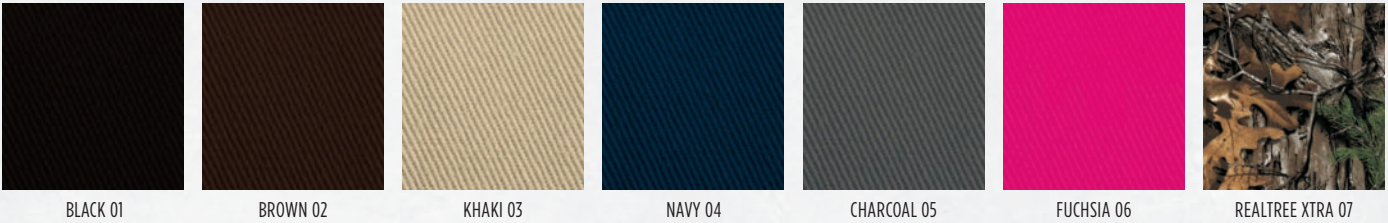

EMBROIDERY COLOR

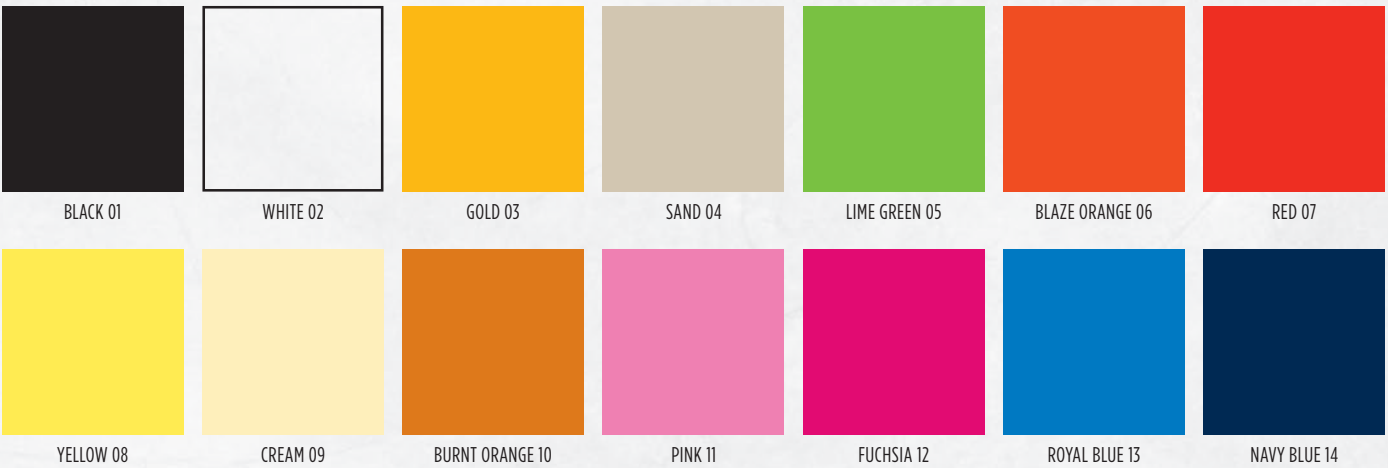



KENAI KNIT

DESCRIPTION	CODE NUMBER	RETAIL	SIZE
Blaze/Black Logo	308509011	15.00	One Size Fits Most



ALL SEASON REVERSIBLE FLEECE

DESCRIPTION	CODE NUMBER	RETAIL	SIZE
RTX/Blaze	308511011	20.00	One Size Fits Most



ELEMENT REVERSIBLE



DESCRIPTION	CODE NUMBER	RETAIL	SIZE
RTX/Stone	308528241	25.00	One Size Fits Most



ALL SEASON REVERSIBLE KNIT

DESCRIPTION	CODE NUMBER	RETAIL	SIZE
Camo/Blaze	308530011	25.00	One Size Fits Most



A



B

JUNEAU FLEECE



	DESCRIPTION	CODE NUMBER	RETAIL	SIZE
A	RTX/Gold Logo	308519241	17.00	One Size Fits Most
B	MOBUC/Gold Logo	308519281		



ECHO TACTICAL

DESCRIPTION	CODE NUMBER	RETAIL	SIZE
Black	308554991	17.00	One Size Fits Most



QUIK-COVER MULTI-FUNCTION HEAD GEAR

Versatile piece can be worn as a beanie, neck gaiter, headband, balaclava and more • Seamless tubular construction helps prevent chafing • Unique fabric makeup helps control human scent • Offers excellent UV protection



NEW 2016	DESCRIPTION	CODE NUMBER	RETAIL	SIZE
(SHOWN IN SHADOW GRASS BLADES)				
	MOSGB	308526251	20.00	One Size Fits Most
	MOBUC	308526281		
	RTM5	308526761		
	RTX	308526241		
	AU	308526081		
	FG	308526091		

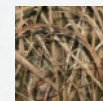

Mossy Oak Shadow Grass Blades

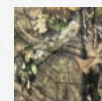

Mossy Oak Break-Up Country

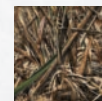

Realtree Max-5

A-TACS 2.0
ADVANCED TACTICAL CONCEALMENT SYSTEM

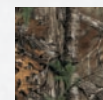

Realtree Xtra

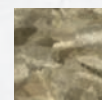

A-TACS AU

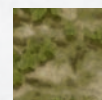

A-TACS FG



Versatile piece can be worn as a beanie, neck gaiter, headband, balaclava and more

From world-class shooters to the hardest of the hardcore hunters to unique personalities, the members of the Browning Pro Staff all share a love of the outdoors, the shooting sports and the greatest gun brand in the world. Pro Staff members are chosen for their skill, professionalism and enthusiasm in promoting the Browning brand. Look for these faces at major shooting events and on your television screen.

WILLIAM AND McLEAN RUSSELL



BOUNDLESS
HUNTING

William and McLean Russell grew up on the family ranches in Texas and have had a gun in their hands since they could walk. Taking full advantage of the wealth of hunting and shooting possibilities offered in their home state, the brothers have put their passion for the outdoors into *Boundless Hunting TV*.

This exciting show takes the Russell brothers across the globe in search of life-changing hunting adventures. While they may be brothers, the pair are quite different. William prefers to take extreme hunting to the next level with his knowledge of tracking and survival techniques, and McLean uses his interests in photography, cooking and game management to bring a unique twist to the program.

What really sets *Boundless Hunting* apart from other hunting shows is its message of family and the bonds created by being outdoors.

WILLI SCHMIDT



Pt
PUREHUNTING

Once mired in the corporate world, Willi Schmidt took the leap and decided to pursue his passion for the outdoors as a host on outdoor TV. This new pursuit led him on the path to showcase the way he loved to hunt, with the challenge of succeeding and failing on his own.

As the host of *Pure Hunting*, Willi takes you on his Do-it-Yourself adventures and shows that pure hunting opportunities still exist for those willing to put in the effort. *Pure Hunting* explores the training, nutrition and gear that goes into the preparation of a self-sustained hunt. Willi appreciates the journey leading up to the hunt, not just the result and he enjoys the friendships made and camaraderie experienced along the way.

MATT HUGHES



Matt Hughes is a nine-time UFC® World Welterweight Champion who was inducted into the UFC Hall of Fame in 2010. Matt spent a good portion of his younger years hunting and shooting — passions that have never left him.

Matt is now the host of the television show *Uncaged*. This unscripted reality show gives you an inside look at his hunting adventures and gives unprecedented access inside Matt's life beyond the Octagon as a husband, father and hunter.

Uncaged follows Matt as he travels in pursuit of some of the world's most challenging big game species.

FRED ZINK



As host of the popular TV series, *Avian-X*, Fred Zink shares the excitement of waterfowling as he embarks on hunts throughout the U.S. and Canada. Along the way he shares the secrets of his highly successful calling tactics and strategies.

Fred founded Zink Calls™ in 2001 as a way to put exceptional calls into the hands of waterfowlers and professionals who demanded high-end calls. A nationally-recognized goose caller in his own right, Zink's business continues to grow and set new standards in the industry.

Zink's high-octane 24/7 DVD series is designed to speak to hunters with exciting footage that shares his hunting experiences with his viewers.

BOB REDFERN



Bob Redfern's experience as an outdoor TV personality extends back more than 35 years. With his lifelong devotion to promoting hunting, shooting sports, fishing, and conservation efforts, Bob ventured out on his own in 2001 to begin the highly successful outdoor series, *Bob Redfern's Outdoor Magazine*.

Bob enjoys bringing the outdoors and the best it has to offer to the screen each week featuring real life hunting and fishing adventures with featured segments on how to succeed at hunting, shooting, and fishing as well as the award-winning *Sportsman's Table* weekly cooking segment. Each week Bob features hunting and fishing destinations around the country for the sportsman who seeks the best places to enjoy the outdoors year round.

ANDREW VAVRA, BOB ST. PIERRE AND ANTHONY HAUCK



Andrew Vavra, Bob St. Pierre and Anthony Hauck are the hosts of Pheasants Forever's *Rooster Road Trip*, an exciting online program that takes hunters road tripping across the country, hunting exclusively on public land, in pursuit of America's most popular upland game bird.

But their dedication to hunting and conservation goes well beyond the entertainment industry. Andrew is a published writer, accomplished blogger and serves as the Marketing Manager for Pheasants Forever. Bob is also a well-known blogger and spends his non-hunting hours as the Director of Marketing and Public Relations at Pheasants Forever and Quail Forever. Anthony also works at Pheasants Forever as the online editor.

Go to pheasantsforever.org to view episodes of *Rooster Road Trip*. While there, join Pheasants Forever and help ensure the future of the pheasant and its habitat.

CHRIS DENHAM



Chris Denham is one of the hosts of *Western Hunter TV*, a program committed to teaching and entertaining viewers hunting in the vast expanse of the American West.

Chris brings notable credentials to the program. He was the editor of *Western Hunter Magazine* for nearly a decade and has spent the better part of 30 years in the hunting industry. As a passionate hunter and guide, he possesses a great deal of knowledge about the region and its game animals.

One of his most important endeavors is the group Outdoor Experience 4 All, which helps children with terminal or life-limiting illnesses get into the field on a hunting trip of their own.

JESSI JO STANFILL, JESS HULL AND KRISTY LEE COOK



MOST WANTED LIST

Girls will be girls — and hunting and being outdoors shouldn't change that. Country music singer Kristy Lee Cook is a long-time member of the Browning Pro Staff and her new program, *Most Wanted List*, is her latest endeavor.

Kristy brought her amazing voice to the TV screen on the 7th season of *American Idol*®. Now Kristy is a rising country music singer and possesses an infectious passion for everything she does, whether it is singing, hunting or saving horses through the Kristy Lee Horse Heaven Foundation.

Her new show, *Most Wanted List*, takes the bucket list concept up a notch and focuses on Kristy and her friends Jess Hull and Jessi Jo Stanfill as they embark on a series of adventures. These three ladies take to the road and travel across the country on an epic adventure full of dream hunts, friendship, challenges and the satisfaction of achieving their lifelong goals.

ROBBIE PURSER



Robbie started shooting skeet at the age of six. Over the years he has accumulated an impressive list of shooting titles including 1980 World Skeet Champion, 1991 and 1998 NSCA Champion, Zone 4 Champion, Quail Unlimited Champion, four-time Ducks Unlimited Champion, 2002 Sportsman Team Challenge Champion and an ESPN Great Outdoor Games gold medalist. He is also a twelve-time All-American Team member, a member of Team USA and a ten-time Georgia State Champion. All told, Robbie has more than 200 tournament wins to his credit.

RICK AND JULIE KREUTER



Husband and wife hunting duo Rick and Julie Kreuter host *Beyond the Hunt*. This unique program follows this dynamic pair on more than just their hunting adventures, it also focuses on wildlife conservation and land management.

Rick grew up in the outdoors of Wyoming and adventure has been a part of his life from an early age. After graduating from college, Rick received his guide license and soon became an outfitter full time.

Julie has also had a love of the outdoors from her earliest days in Nebraska. She and Rick were married after she received her degree in Physical Therapy.

As their outfitter business grew, so did their success and popularity, and after 16 years of guiding hunters, *Beyond the Hunt* is their own adventure.

JARED WIHONGI



Jared Wihongi has more than 25 years of martial arts experience and is trained in the Filipino blade-fighting system of Pekiti-Tirsia Kali.

As a sought after instructor, Jared has worked with the U.S. Army Special Forces Groups, the DEA, Philippine National Police Academy, Special Action Force commandos, Marine Force Recon and Germany's GSG-9 to name a few.

Originally from New Zealand, home of the legendary Maori warriors, he currently serves as a reserve SWAT officer in a city near the Browning headquarters in Utah.

Jared works closely with Russ Kommer on the development of every Browning Black Label Tactical knife to make sure they are up to our demands and meet the real world needs of discerning users like you.

JOHNNY MEITZEN

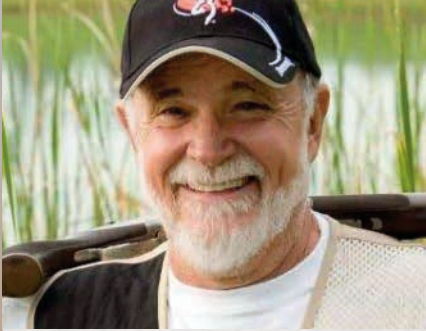

Johnny Meitzen has been a Browning Pro Staffer for years and was recently honored when he was inducted into the Texas Sporting Clays Hall of Fame.

Johnny started shooting competitively in 1987 and has shot over 100,000 competitive matches, winning a number of shooting titles including two-time NSCA Nationals Vet Champion and two-time NSCA Nationals FITASC Vet Champion. Johnny is a six-time All-American Sporting Team member, two-time Team USA Sporting member and two-time Team USA FITASC member. He also has many state and zone championship titles to his credit. He is an NSCA Level III instructor and a die-hard Citori man who currently shoots a Citori 725 Sporting.

FOSTER AND MATT BARTHOLOW



Foster and Matt are rising stars on the ATA trapshooting circuit, and both shoot Browning Citori shotguns. The brothers came up through the Scholastic Clay Target Program and have made their mark within the pro ranks. Matt has earned several Grand American Championship titles, holds the 2nd Longest recorded singles run at 1840, achieved his Grand Slam (and Grand American Grand Slam), owns several South Dakota State Champion titles and is a three time All American Team member.

Foster is also a Grand American Champion and set a shoot off record at the Grand with 200 targets in program and 900 in shoot off. He is a two time All American Team member, achieved his Grand Slam (and Grand American Grand Slam) shooting 200 singles, 100 doubles and 100 handicap from the 27 yard line. He too holds multiple South Dakota State Champion titles.

Both Matt and Foster will tell you that the Citori shotgun is a workhorse that just keeps on shooting, round after round, year after year.

RUSS KOMMER



Russ Kommer is the man responsible for most of our lineup of world-class knives.

Russ grew up in the north woods of Minnesota, hunting, fishing, trapping and logging. His career as a guide took him to Idaho in search of big game in the formidable Selway-Bitterroot Mountains and eventually led him to guide hunters in the wilds of Alaska.

Having to dress big game as a hunting guide, Russ learned the meaning of the word quality, and how important it is in a knife. His experiences quickly taught him what he needed in his knives and, when he couldn't find what he wanted, started making his own knives to meet his demanding needs.

Now a world renowned name in the knife industry, Russ spends much of his time on his ranch in North Dakota developing new designs.

TOMMY THACKER



With a nickname like "Tommy Gun," you had better be fast on the trigger — especially if you are competing on the 3-Gun Nation tour.

Tommy Thacker is ranked among the best 3-Gun competitors in the nation, amassing an impressive list of victories and top finishes that includes winning the 3-Gun Nation Pro Series Championship in 2011 and 2012. With his success, Tommy has his pick of autoloading shotguns — he chooses to get it done with his Browning A5.

ALEX WAMPLER



Californian Alex Wampler began shooting sporting clays in 2004 and by 2007 had earned her way onto the All American Team. In addition to winning the 2013 US Open Lady FITASC Championship, she has been National Lady Sub Gauge HOA champion, regional champion and California Ladies Champion each on several occasions.

Her shooting interests also go beyond the range. She is a guide at Birds Landing Hunting Preserve, an NRA Range Safety Officer and attends the University of California Davis with aspirations to become a veterinarian.

GREG JORDAN



What began in 2007 as shooting in a few local USPSA matches has become a full-fledged career for Greg Jordan.

Like many shooters, Greg caught the bug and his new hobby soon turned into a passion. Two short years later he earned the title of USPSA Grand Master and found a new interest, 3-Gun competition.

Greg's hard work and commitment to practice, training and equipment continues to pay off. In 2014 he became 3-Gun Nation Champion with his Browning A5.

TENNILLE CHIDESTER



Hailing from Salt Lake City, Utah, Tennille Chidester began shooting competitively in the USPSA ranks in her mid teens. Now she has found her true passion as a competitor in the 3-Gun Nation Pro Series, with her reliable Browning A5 speeding her through the shotgun events. You may also recognize Tennille as a competitor on season 4 of *Ammo and Attitude*, which she won.

In addition to the fast-paced competition, it is the amazing people and camaraderie that draws Tennille to the exciting sport of 3-Gun shooting. She especially enjoys introducing others to the sport and encouraging their development.

SHILOAH MATTOON



Born in the small town of Kamiah, Idaho, Shiloah Mattoon fondly recalls that firearms have always been a part of his life. His competitive shooting career began in 2011, and his early experiences ignited Shiloah's passion for 3-Gun competition. Now he competes against the best shooters in the 3-Gun Nation tour.

In addition to having a full-time job, Shiloah spends hours practicing and takes an athletic approach to the sport, training daily in the gym.

Shiloah shoots a Browning A5 with absolute faith in its unwavering reliability and Speed Load Plus feature.



As much an emblem of the outdoor lifestyle as it is of the Browning brand, the Buckmark is the most recognizable symbol in the firearm industry. Whether on vehicles, T-shirts, caps, or permanently inked on the body, the Buckmark is a statement about your lifestyle. We have partnered with the companies on the following pages to represent the Browning brand with quality products and to share the Browning commitment to the outdoor industry.

AIRGUNS

High-performance designs like the 800 Series pistols, replica Buck Mark, and under-lever cocking Leverage Air Rifle are cornerstones of this versatile line-up of top-quality airguns.

UMAREX USA

7700 Chad Colley Blvd., Fort Smith, AR 72916

Phone: 479-646-4210

www.umarexusa.com/browning



NEW
2016

AMMUNITION

Browning and Winchester team up to create a full line of advanced technology ammunition for shotgun, rifle, handgun and rimfire shooters.

BROWNING AMMUNITION

PO Box 699, Arnold, MO 63010

www.browningammo.com

BED AND BATH

Available Products: Sheet Sets • Comforter Sets • Drapes • Valances • Accent Pillows • Crib Bedding • Bath Towels • Bath Mats • Toothbrush Holders • Waste Baskets • Tumblers • Lotion Pumps • Shower Curtain Hooks • Soap Dishes • Tissue Box Covers • Night Lights • Throws • Wall Border • Area Rugs

KIMLOR INNOVATIVE HOME FASHIONS

2630 St. Matthews Rd., Orangeburg, SC 29118

Phone: 800-762-0007

www.kimlor.com

CAMPING

Hunting camps require sturdy and weather-resistant tents, warm and comfortable sleeping bags, air pads that soften the ground and add warmth, furniture that is durable and comfortable and fully featured hunting blinds.

ALPS

4575 Hwy. 185, New Haven, MO 63068

Phone: 800-344-2577

www.browningcamping.com

CASUAL SPORTSWEAR

Our lifestyle casual sportswear includes outdoor and casual belts and suspenders, rugged work wear, plus performance and classic casual pieces that provide style and comfort day-in and day-out. You'll appreciate our unique details and thoughtfully selected colors.

SIGNATURE PRODUCTS GROUP

1490 N. 2200 W., Salt Lake City, UT 84116

Phone: 800-553-1098

www.spgcompany.com

FISHING

Lightweight, precision geared casting reels, sensitive, high tensile strength carbon rods and durable machined aluminum pliers offer serious value and performance to every angler.

BASS PRO SHOPS

2500 E. Kearney, Springfield, MO 65898

Phone: 417-873-5274

www.browningfishing.com

GIFTS

Lifestyle-driven gift and stationery products that make fine gifts, plus a large selection of other unique products is available from games, to jewelry, to wrapping paper.

SIGNATURE PRODUCTS GROUP

1490 N. 2200 W., Salt Lake City, UT 84116

Phone: 800-553-1098

www.spgcompany.com

OUTDOOR COOKWEAR

Committed to providing a full selection of high quality cooking equipment for the true sportsman who is dedicated to cooking for hunters with an appetite.

CAMP CHEF

3985 N. 75 W., Hyde Park, UT 84318

Phone: 800-650-2433

www.campchef.com

METAL PRODUCTS

Helping outdoorsmen enjoy juicy steaks or grilled trout fresh from the day's catch by cooking them on a grill or smoker. Food processing equipment including grinders, slicers and dehydrators are also available.

RANKAM GROUP

1618 W. Rosecrans Ave., Gardena, CA 90249

Phone: 248-330-8273

www.rankam.com

SIGNATURE AUTOMOTIVE

Automotive accessories that showcase the iconic Buckmark, with a full line of quality interior and exterior products designed to provide protection and personalization and compliment the outdoor lifestyle.

SIGNATURE PRODUCTS GROUP

1490 N. 2200 W., Salt Lake City, UT 84116

Phone: 800-553-1098

www.spgcompany.com

SOCKS

Made in the USA equates to quality and immediate availability. Socks are produced using only premium materials and the latest fiber technologies and are ready for all season wear with warmth, comfort and durability for every member of the family.

CAROLINA HOSIERY

2316 Tucker St., Burlington, NC 27215

Phone: 336-226-5581

www.carolinahosiery.com

SPORTING BAGS AND TRAVEL GEAR

High quality packs and bags geared to meet all your carry needs. Whether you're out hunting, traveling, or just showing your Buckmark pride, our line will be what you're looking for. Durable materials, customer understanding, and product innovation provide the right tools for the right job.

SIGNATURE PRODUCTS GROUP

1490 N. 2200 W., Salt Lake City, UT 84116

Phone: 800-553-1098

www.spgcompany.com

TRAIL CAMERAS

A complete line of motion-sensing trail cameras capable of capturing still pictures, video clips or time-lapse imagery of game. Tree mounts, SD cards, security boxes and batteries are also available.

PROMETHEUS GROUP

Two Perimeter Park South, Suite 305 East, Birmingham, AL 35243

Phone: 888-618-4496

www.browningtrailcameras.com



POLARIS
RANGER
FEATURING PROSTAR



NEW! 44hp PROSTAR® ENGINE | 2000 LBS. TOWING CAPACITY | PRO-FIT CAB INTEGRATION ADVANTAGE

GO FURTHER, HUNT LONGER.

INTRODUCING THE ALL-NEW 2015 POLARIS RANGER® 570 FULL-SIZE

Legendary off-road performance, modern conveniences, unstoppable durability – RANGER® takes you where trophies lurk, and back. With industry leading ProStar® power and easy to accessorize Pro-Fit integration, these are the Hardest Working, Smoothest Riding off-road vehicles period.

CHECK OUT GREAT DEALS
» SEE YOUR LOCAL POLARIS DEALER FOR DETAILS

WARNING: The Polaris® RANGER® can be hazardous to operate and is not intended for on-road use. Driver must be at least 16 years old with a valid driver's license to operate. Passengers must be at least 12 years old. Drivers and passengers should always wear helmets, ROPS protection, and seat belts. Always use safe nets or doors (as equipped). Never engage in stunt driving, and avoid excessive speeds and sharp turns. Riding and alcohol/drugs don't mix. All drivers should take a safety training course. Call 800-942-0764 for additional information. Check local laws before riding on trails. ©2015 Polaris Industries Inc.



**NEW! 2015 RANGER®
570 FULL-SIZE
SAGE GREEN**



**NEW! 2015 RANGER®
570 FULL-SIZE
TURBO SILVER**

BUILD YOUR PERFECT RANGER® AT POLARIS.COM



BROWNING IS COMMITTED TO SERVING YOU

Every effort has been made to ensure that all product photographs, descriptions and specifications in this catalog are accurate; however, inadvertent errors may occur. Changes in design or materials due to our continual effort to improve products may result in specification changes before subsequent publications are issued. Browning reserves the right to modify or change specifications without notice.

BE A SAFE SHOOTER



Read and follow all safety information in the owner's manual provided with each firearm before use. Additional copies are available for free download on the Browning website. Browning endeavors to make the safest firearms possible; however, firearm safety begins with you. At all times treat any firearm with intense respect for its power and potential danger. Always point the muzzle in a safe direction. There is no excuse for careless or abusive handling of any firearm.

BROWNING.COM • 800-333-3288

Browning • One Browning Place • Morgan, UT 84050-9326

Distributed in Canada by:

Browning Canada Sports Ltd/Ltée

5583 Chemin St-François, St-Laurent, Quebec H4S 1W6

©Copyright, Browning, December 2015. No part of this catalog may be reproduced without the written permission of Browning.
Printed in U.S.A. GAC1512175/15031

PRICES IN US \$ / LES PRIX SONT EN \$ US