



2015
MASTER
CATALOG



FIREARMS

BROWNING®



WELCOME TO MOSSY OAK COUNTRY.



Country means something a little different to everyone. It might be the music you listen to. Maybe it's a location anywhere except the city. Maybe country is a way of life that is just a whole lot more easygoing.

The folks at Mossy Oak see country as being all those things and more. They think of country as a lifestyle, one in which hunting and spending time in the great outdoors is a big part. They know that time outdoors is family time, and that is time well spent. This is why we are proud to introduce Mossy Oak's all new Break-Up Country® camouflage pattern.

Break-Up Country is the first camo pattern ever that utilizes true-to-life size elements, unmatched digital clarity and accuracy to conceal your outline anywhere and in any season you hunt. In Break-Up Country, the elements are larger and more sparse to prevent the muddy darkness of other patterns. All the elements are actual objects, precisely represented in a digital format for unmatched realism and concealment. The leaf you see is a picture of a leaf, not just an artist's rendition.

When you remove all the technical jargon, Mossy Oak Break-Up Country is more than just another camo pattern, at its core, it's the country life itself.

Welcome to Break-Up Country.

BREAK-UP
COUNTRY

TOTAL BARREL DYNAMICS — FROM EXPERIMENTATION TO SCIENCE

- Our engineers have fired literally millions of shells in order to improve the relationship between the shotgun barrel and shotshell. What began as experiments have become the science of shot pattern performance.
- Extensive testing has shown that shot is deformed as it passes through the restrictions of the forcing cone, a tight bore and the choke tube. When shot is deformed it is less stable in flight, leading to flyers and holes in patterns. Our Vector Pro lengthened forcing cone is designed to reduce stress on the shot column, and Back-Bored Technology allows the shot column to exit the barrel at maximum velocity. Our proven choke tube technologies further minimize the stress placed on the shot as it exits the barrel while constricting it to the pattern you need. Other manufacturers use shorter forcing cones that smash the shot, a bore that is too tight or loose, and shorter choke tubes that result in inferior pattern performance.
- Total Barrel Dynamics — standard on A5, Maxus, BT-99 and on 12 and 20 gauge Citori and Cynergy models — is a system of technologies that function together to reduce shot deformation and significantly improve pattern consistency and performance. Each component of Total Barrel Dynamics plays a part in keeping shot patterns whole and pellets on target, and to ignore any single part weakens performance.

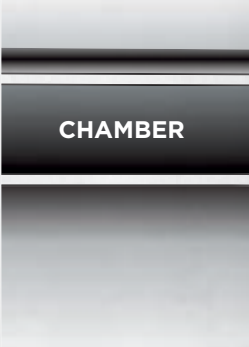

CHAMBER

FEATHER TECHNOLOGY

HEAVY DUTY, LIGHT WEIGHT

- Feather technology significantly reduces the weight of an over and under shotgun (about one pound) by using a high quality alloy for the receiver rather than steel.
- To maintain maximum durability, the breech face is a dovetailed steel insert.
- Citori models also use a full-width steel hinge pin and Cynergy shotguns feature steel MonoLock Hinge surfaces.

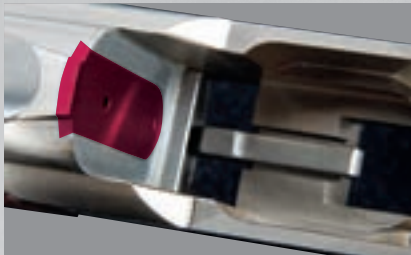

STEEL BREECH FACE

All Feather models feature a steel breech face that resists wear, allowing the receiver to be built from weight-saving alloy.



CITORI STEEL HINGE PIN

The full-width, steel hinge pin in the Citori provides maximum strength and lasting endurance.



CYNERGY STEEL INSERTS

To ensure longevity, steel inserts are added to the MonoLock Hinge.

RECOIL REDUCTION TECHNOLOGIES



INFLEX TECHNOLOGY RECOIL PAD

- Inflex recoil pads incorporate directional deflection construction that guides the comb down and away from your face, reducing felt recoil for greater shooting comfort and faster, more accurate follow-up shots.
- The Inflex recoil pads are made from a soft material for the best recoil absorbing performance available.

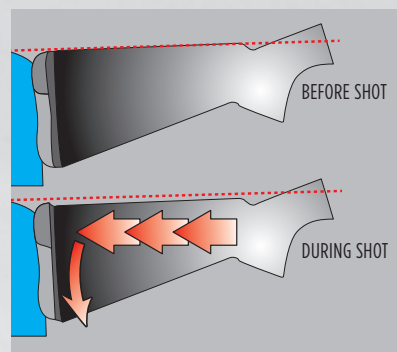

STOCK FINISHES

MAXIMUM GRIP

- Dura-Touch Armor Coating is extremely durable.
- Improves grip in wet and cold conditions.



FOR SMALLER SHOOTERS

MICRO MIDAS FIREARMS

- Micro Midas firearms are specifically designed to give younger or smaller shooters a high quality, great fitting firearm.
- Micro Midas firearms are constructed with the same quality components and attention to detail as all Browning firearms.

BROWNING GROWTH INSURANCE PROGRAM

- Micro and Micro Midas models are eligible for the Growth Insurance Program that allows new owners to purchase a full-size stock at 50% off the retail price.
- Growth Insurance allows Micro and Micro Midas firearms to grow with the shooter.
- Offers you a higher rate of return on your firearm investment.
- Visit browning.com for complete details.

ALL BROWNING FIREARMS ARE SHIPPED WITH A FREE LOCKING DEVICE TO ASSIST IN THE SAFE STORAGE OF FIREARMS.



VECTORPRO™

BACK-BORED TECHNOLOGY

INVECTOR-DS
INVECTOR-Plus™

VECTOR PRO

LONGER IS BETTER. THE ADVANTAGES OF A LENGTHENED FORCING CONE

- The forcing cone is the tapered transition between the chamber and the bore that constricts the shot column. The longer the forcing cone is, the more gradual the constriction.
- A gradual constriction reduces stress on the shot column as it passes into the bore, resulting in fewer deformed pellets. Less pellet deformation produces more uniform patterns and keeps more pellets in the central part of the pattern. Vector Pro is better than the competitors' forcing cone designs because of the more gradual constriction.
- Lengthening forcing cones is a popular and expensive aftermarket practice done to increase shot pattern performance. But it comes standard on A5, Maxus, BT-99 and on 12 and 20 gauge Citori and Cynergy models.

BACK-BORED TECHNOLOGY

WHAT IS BACK-BORING?

- Back-boring enlarges the bore to the maximum diameter to increase shot velocity, minimize pellet deformity for more uniform patterns and reduce felt recoil.
- Extensive testing has shown that Back-Bored Technology reduces the friction between the shot cup and the bore, but does not allow gases to slip past the shot cup that would result in reduced pellet velocity and blown patterns.
- Back-Bore Technology specifications minimize shot deformation and maximize pattern uniformity, consistency and density. Back-Bored Technology is standard on A5, Maxus, BT-99 and on 12 and 20 gauge Citori, Cynergy, BPS and Silver models.

INVECTOR-DS

TAKING CHOKE TUBES TO THE MAX

- Invector-DS choke tubes combine muzzle-end threads and thin-wall construction for a longer, more gradually tapered choke tube that produces extremely consistent, dense shot patterns.
- From Cylinder to Extra Full, Invector-DS shot patterns tighten consistently in reliable, evenly scaled steps.
- Muzzle threads minimize the flare at the end of the barrel for improved shotgun appearance. A slightly lighter overall barrel weight is achieved for faster swinging and improved balance.
- The more gradual taper of Invector-DS choke tubes reduces shot deformation for fewer flyers and gaps in the pattern and allows higher shot velocities for hard hitting performance.
- The "DS" stands for double-seal. Our proprietary differential-banded brass seal compresses against the barrel wall to keep the choke tube threads clean and make installation and removal easier than any other muzzle thread system.
- Invector-DS is standard on A5 and Citori 725 models.
- View the full line of Invector-DS choke tubes on pages 145 and 147.

STANDARD
INVECTOR™

STANDARD INVECTOR

PATTERN VERSATILITY FOR 10 GA., 16 GA., 28 GA. AND .410 BORE SHOTGUNS

- The Standard Invector interchangeable choke tube system offers consistent, dense shot patterns with the constriction needed for the shooting situation.
- Threads on the breech end help prevent gases from slipping between the choke tube and barrel that could damage the choke tube and the barrel.
- Standard Invector is standard on 10, 16 and 28 gauge, and .410 bore Citori, Cynergy, Gold and BPS models.
- See pages 144 through 149 for a complete listing of choke tubes.

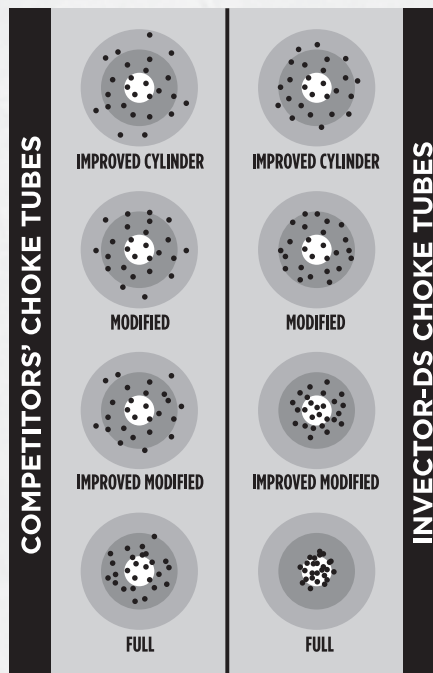

INVECTOR-DS CHOKE TUBES VS. COMPETITORS' CHOKE TUBES

Invector-DS tubes have even pattern percentage increments, offering just the right pattern for any shooting situation.

Competitors' choke tubes show little pattern difference between choke constrictions.

INVECTOR-PLUS

CHAMPIONSHIP PROVEN PERFORMANCE

- Invector-Plus started the long choke tube revolution. An ever-growing collection of championship medals is proof of its patterning performance.
- The Invector-Plus choke tube system works with Vector Pro and Back-Bored Technology to offer consistent, dense shot patterns with the constriction needed for the shooting situation.
- The long choke taper inside an Invector-Plus choke tube produces consistent patterns with more uniform densities and fewer flyers.
- Threads on the breech end help prevent gases from slipping between the choke tube and barrel that could damage the choke tube and the barrel.
- Invector-Plus is standard on 12 and 20 gauge Maxus, Citori, Cynergy, Silver, BPS and BT-99 models.
- View the full line of Invector-DS choke tubes on pages 145 and 147.

THE BROWNING HIGH GRADE PROGRAM — YEAR THREE.

For a unique, limited edition firearm, look no further than the Browning High Grade Program. 2015 brings the in-demand Citori 725 to the artisan's workbench, where these fine over and unders receive as much as 30 hours of hand-engraving and touch-up prior to being precisely set into finely wrought, high-grade walnut.

NEW**NEW**

Fitted John M. Browning Signature distressed leather case included with the Citori 725 Sporting Grade VII.



Canvas/distressed leather fitted case included with the Citori 725 Sporting Grade V.



A CITORI 725 SPORTING GRADE V



Grade V Engraving, Right



Grade V Engraving, Left



Grade V Engraving, Bottom



B CITORI 725 SPORTING GRADE VII



Grade VII Engraving, Right



Grade VII Engraving, Left



Grade VII Engraving, Bottom

A CITORI 725 SPORTING GRADE V

RECEIVER Steel • Low profile • Silver nitride finish • Grade V deep-relief engraving **BARREL** Ventilated top and side rib • Ported **ACTION** Fire Lite mechanical trigger system • Hammer ejectors • Top-tang barrel selector/safety **STOCK** Oil finish Grade IV/V walnut with close radius pistol grip and palm swell **FEATURES** Vector Pro lengthened forcing cones • Five Invector-DS Extended choke tubes • HiViz® Pro-Comp sight and ivory mid-bead • Inflex recoil pad • Fitted canvas/distressed leather case included **IDEAL USAGE** Hunting/Sporting Clays

B CITORI 725 SPORTING GRADE VII

RECEIVER Steel • Low profile • Blued finish • Gold accented Grade VII deep-relief engraving **BARREL** Ventilated top and side rib • Ported **ACTION** Fire Lite mechanical trigger system • Hammer ejectors • Top-tang barrel selector/safety **STOCK** Oil finish Grade VI/VII walnut with close radius pistol grip and palm swell **FEATURES** Vector Pro lengthened forcing cones • Five Invector-DS Extended choke tubes • HiViz® Pro-Comp sight and ivory mid-bead • Inflex recoil pad • John M. Browning Signature fitted case included **IDEAL USAGE** Hunting/Sporting Clays

NEW 2015	GAUGE	CODE NUMBER	SUGGESTED RETAIL	BARREL LENGTH Inches	CHOKES Included	CHAMBER Inches	AVERAGE WEIGHT lbs./Oz.	OVERALL LENGTH Inches	DROP AT COMB Inches	DROP AT HEEL Inches	LENGTH OF PULL Inches	RIB WIDTH Inches
CITORI 725 SPORTING GRADE V												
A	• 12	0136823009	5,339.99	32	F,IM,M,IC,SK	3	7 / 10	50	1-9/16	2-3/8	14-3/4	5/16-7/16
	• 12	0136823010	5,339.99	30	F,IM,M,IC,SK	3	7 / 8	48	1-9/16	2-3/8	14-3/4	5/16-7/16
CITORI 725 SPORTING GRADE VII												
B	• 12	0180013009	6,269.99	32	F,IM,M,IC,SK	3	7 / 10	50	1-9/16	2-3/8	14-3/4	5/16-7/16
	• 12	0180013010	6,269.99	30	F,IM,M,IC,SK	3	7 / 8	48	1-9/16	2-3/8	14-3/4	5/16-7/16



ONE WITH THE GUN.

The Citori 725 combines legendary reliability with the pointability and feel of a low profile receiver and the precision of a mechanical trigger. Lightweight, precisely fit and finished, quick to the shoulder and even quicker to the target, the Citori 725 is the ideal way to feel “one with the gun.”

725

CITORI

PRO



TRIPLE TRIGGER SYSTEM

- The Triple Trigger System fine tunes finger-to-trigger reach on target models.
- Includes three trigger shoes: Wide checkered, narrow smooth and wide smooth canted.

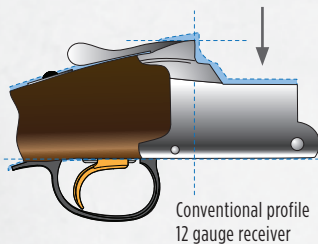

LOW PROFILE RECEIVER

- Improved recoil control and less muzzle jump are two of the big benefits of a low profile receiver. There is also the “one with the gun” feeling that makes the Citori 725 feel like an extension of the body.
- Places the front hand closer to the bore line for superior hand-eye coordination and pointability.



PALM SWELL

- Aids in control.
- Optimizes finger-to-trigger placement.
- Provides a comfortable, secure grip.

PRO FIT ADJUSTABLE COMB



- The new Browning Pro Fit Adjustable Comb makes it easy to find the perfect comb position.



- Pro Fit offers single bolt adjustment for both cast and drop. The revised design allows the stock to be professionally fit for shorter length of pull.
- Easy to read markings allow the shotgun to be dialed-in and easily replicated should the comb be removed.

PRO BALANCE SYSTEM

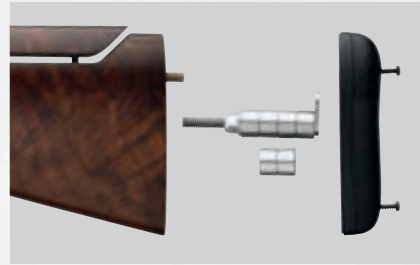

- The Pro Balance System allows shooters to fine-tune the balance point for a perfect mount and swing.
- Adding weights to the stock helps balance the shotgun, aids follow-up shots and the additional mass reduces felt recoil.



- Stock weights reduce muzzle jump for more accurate follow-up shots and allow a smoother follow through.
- Pro Balance weights are easy to install.



INVECTOR-DS CHOKE TUBE SYSTEM

- Citori 725 Pro models include five extended Invector-DS tubes.
- Invector-DS choke tubes combine muzzle-end threads and thin-wall construction for a longer, more gradually tapered choke tube that produces extremely consistent, dense shot patterns.
- From Cylinder to Extra Full, Invector-DS shot patterns tighten consistently in reliable, evenly scaled steps.
- The more gradual taper of Invector-DS choke tubes reduces shot deformation for fewer flyers and gaps in the pattern and allows higher shot velocities for hard hitting performance.
- The “DS” stands for double-seal. Our proprietary differential-banded brass seal compresses against the barrel wall to keep the choke tube threads clean and make installation and removal easier than any other muzzle thread system.

ALL BROWNING FIREARMS ARE SHIPPED WITH A FREE LOCKING DEVICE TO ASSIST IN THE SAFE STORAGE OF FIREARMS.

CITORI 725 PRO — COMPETITION GRADE PERFORMANCE.

Be it for a paycheck or bragging rights, a top-notch shotgun is essential for maximum scores. 725 Pro models offer a host of performance extras straight from the box.

NEW



A CITORI 725 PRO SPORTING WITH PRO FIT ADJUSTABLE COMB



Pro Sporting Engraving, Right

NEW



B CITORI 725 PRO TRAP WITH PRO FIT ADJUSTABLE COMB



Pro Trap Engraving, Right

A CITORI 725 PRO SPORTING WITH PRO FIT ADJUSTABLE COMB

RECEIVER Steel • Low-profile (12 gauge) • Silver nitride finish • Gold accented engraving **BARREL** Ventilated top and side ribs • Ported **ACTION** Fire Lite Mechanical trigger system • Hammer ejectors • Top-tang barrel selector/safety **STOCK** Gloss oil finish Grade III/IV walnut with close radius pistol grip and palm swell • Pro Fit Adjustable Comb • Inflex recoil pad **FEATURES** Vector Pro lengthened forcing cones • Five Invector-DS extended choke tubes • Pro Balance System • Triple Trigger System • HiViz® Pro-Comp sight and ivory mid-bead **IDEAL USAGE** Sporting Clays/Skeet

B CITORI 725 PRO TRAP WITH PRO FIT ADJUSTABLE COMB

RECEIVER Steel • Low-profile • Silver nitride finish • Gold accented engraving **BARREL** Ventilated top and side ribs • Ported **ACTION** Fire Lite Mechanical trigger system • Hammer ejectors • Top-tang barrel selector/safety **STOCK** Gloss finish Grade III/IV walnut with close radius pistol grip and palm swell • Pro Fit Adjustable Comb • Semi-beavertail forearm with finger grooves **FEATURES** Vector Pro lengthened forcing cones • Five Invector-DS extended choke tubes • Pro Balance System • Triple Trigger System • HiViz® Pro-Comp sight and ivory mid-bead **IDEAL USAGE** Trap

NEW 2015	GAUGE	CODE NUMBER	SUGGESTED RETAIL	BARREL LENGTH Inches	CHOKES Included	CHAMBER Inches	AVERAGE WEIGHT lbs. / Oz.	OVERALL LENGTH Inches	DROP AT COMB Inches	DROP AT HEEL Inches	LENGTH OF PULL Inches	RIB WIDTH Inches
CITORI 725 PRO SPORTING WITH PRO FIT ADJUSTABLE COMB												
•	12	0180024009	3,999.99	32	F,IM,M,IC,SK	2-3/4	7 / 13	50	1-3/4 adj.	2-1/2 adj.	14-3/4	5/16-7/16
A	•	12	0180024010	3,999.99	30	F,IM,M,IC,SK	2-3/4	7 / 11	48	1-3/4 adj.	2-1/2 adj.	5/16-7/16
	•	20	0180027009	3,999.99	32	F,IM,M,IC,SK	2-3/4	6 / 11	50	1-3/4 adj.	2-1/2 adj.	5/16-7/16
	•	20	0180027010	3,999.99	30	F,IM,M,IC,SK	2-3/4	6 / 9	48	1-3/4 adj.	2-1/2 adj.	5/16-7/16
CITORI 725 PRO TRAP WITH PRO FIT ADJUSTABLE COMB												
•	12	0180033009	3,999.99	32	F,LF,IM,IM,M	2-3/4	8 / 11	50	1-11/16 adj.	1-15/16 adj.	14-3/8	1/4-3/8
B	•	12	0180033010	3,999.99	30	F,LF,IM,IM,M	2-3/4	8 / 8	48	1-11/16 adj.	1-15/16 adj.	1/4-3/8



CITORI 725 — LESS GUN, MORE FEATURES.

Citori shotguns are known for their durability, long outliving most over and unders. The Citori 725 models utilize a new low-profile receiver design that retains the features that make the Citori so tough. A mechanical trigger provides superb performance with a light, crisp break.

725 CITORI



TRIPLE TRIGGER SYSTEM

- The Triple Trigger System fine tunes finger-to-trigger reach on target models.
- Includes three trigger shoes: Wide checkered, narrow smooth and wide smooth canted.



HIGH RIB

- Offers increased visibility, the barrels don't cover up the target.
- Improved cooling helps prevent heat waves from distorting visibility.

BECOME
ONE
WITH THE
GUN

**FIRE
LITE**
MECHANICAL
TRIGGER



FIRE LITE MECHANICAL TRIGGER

- Exclusive mechanical trigger design.
- Unlike an inertia trigger, Fire Lite does not rely on recoil to set the next shot; instead, it offers immediate second shot capability.
- Features less take-up, a crisp break and shorter overtravel.
- The Fire Lite Mechanical Trigger is light, crisp and has minimal overtravel.



TAPERED LOCKING BOLT

- Unlike other low-profile over and unders, the Citori 725 features a transverse-mounted, full-width tapered locking bolt and full-width hinge pin just like other Citori models for maximum strength and longevity.
- The locking bolt engages a full-width tapered recess in the monobloc. Tapering the bolt and recess allows the bolt to seat deeper over time, accommodating for wear.

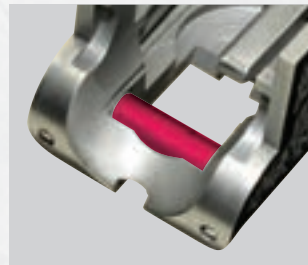

FULL-WIDTH HINGE PIN

The Citori 725's full-width hinge pin provides maximum strength and long-lasting endurance.

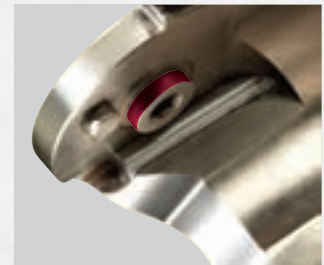

COMPETING TRUNNION DESIGN

The competitors' trunnions provide only a fraction of the bearing surface that the Citori 725's full-width hinge pin provides.

**ERGO
BALANCED**

ERGO BALANCED

- Incredibly balanced in the hands from pad to muzzle.
- Facilitates a light feel and fast swing.
- Promotes follow through.

ALL BROWNING FIREARMS ARE SHIPPED WITH A FREE LOCKING DEVICE
TO ASSIST IN THE SAFE STORAGE OF FIREARMS.

GET A SPORTING CHANCE.

Sporting clays is as challenging as it is exciting, and achieving top scores requires a Browning Citori 725 Sporting. 725 Sporting guns pack a load of features into a rugged and reliable package. Barrel porting keeps recoil light and muzzle climb to a minimum for fast, accurate second shots.



A CITORI 725 SPORTING



725 Sporting Engraving, Right



725 Sporting Engraving, Bottom



B CITORI 725 SPORTING WITH ADJUSTABLE COMB

NEW



C CITORI 725 HIGH RIB SPORTING WITH ADJUSTABLE COMB

RECEIVER Steel • Low-profile (12 gauge) • Silver nitride finish • Gold accented engraving **BARREL** Ventilated top and side ribs • Ported **ACTION** Fire Lite Mechanical trigger system • Hammer ejectors • Top-tang barrel selector/safety **STOCK** Gloss oil finish Grade III/IV walnut with close radius pistol grip and palm swell • Available with adjustable comb • Inflex recoil pad **FEATURES** Vector Pro lengthened forcing cones • Five Invector-DS extended choke tubes • Triple Trigger System • HiViz® Pro-Comp sight and ivory mid-bead **IDEAL USAGE** Sporting Clays/Skeet

	NEW 2015 GAUGE	CODE NUMBER	SUGGESTED RETAIL	BARREL LENGTH Inches	CHOKES Included	CHAMBER Inches	AVERAGE WEIGHT lbs. / Oz.	OVERALL LENGTH Inches	DROP AT COMB Inches	DROP AT HEEL Inches	LENGTH OF PULL Inches	RIB WIDTH Inches
CITORI 725 SPORTING												
A	12	0135313009	3,139.99	32	F,IM,M,IC,SK	3	7 / 10	50	1-9/16	2-3/8	14-3/4	5/16-7/16
	12	0135313010	3,139.99	30	F,IM,M,IC,SK	3	7 / 8	48	1-9/16	2-3/8	14-3/4	5/16-7/16
	20	0135316009	3,139.99	32	F,IM,M,IC,SK	3	6 / 8	50	1-9/16	2-3/16	14-3/4	5/16-7/16
	20	0135316010	3,139.99	30	F,IM,M,IC,SK	3	6 / 6	48	1-9/16	2-3/16	14-3/4	5/16-7/16
CITORI 725 SPORTING WITH ADJUSTABLE COMB, STANDARD RIB												
B	12	0135533009	3,529.99	32	F,IM,M,IC,SK	3	7 / 13	50	1-3/4 adj.	2-1/2 adj.	14-3/4	5/16-7/16
	12	0135533010	3,529.99	30	F,IM,M,IC,SK	3	7 / 11	48	1-3/4 adj.	2-1/2 adj.	14-3/4	5/16-7/16
CITORI 725 HIGH RIB SPORTING WITH ADJUSTABLE COMB												
C	• 12	0136243009	3,599.99	32	F,IM,M,IC,SK	3	7 / 10	50	1-9/16 adj.	2-3/8 adj.	14-3/4	5/16-7/16
	• 12	0136243010	3,599.99	30	F,IM,M,IC,SK	3	7 / 8	48	1-9/16 adj.	2-3/8 adj.	14-3/4	5/16-7/16





A CITORI 725 SKEET



725 Skeet Engraving, Right



725 Skeet Engraving, Bottom



B CITORI 725 SKEET WITH ADJUSTABLE COMB



C CITORI 725 TRAP



D CITORI 725 TRAP WITH ADJUSTABLE COMB

A CITORI 725 SKEET B CITORI 725 SKEET WITH ADJUSTABLE COMB

RECEIVER Steel • Low-profile • Silver nitride finish • Gold accented engraving **BARREL** Floating, ventilated top and side ribs • Ported **ACTION** Fire Lite Mechanical trigger system • Hammer ejectors • Top-tang barrel selector/safety **STOCK** Gloss finish Grade III/IV walnut with close radius pistol grip and palm swell • Available with adjustable comb • Semi-beavertail forearm with finger grooves • Inflex recoil pad **FEATURES** Vector Pro lengthened forcing cones • Three Invector-DS choke tubes • Triple Trigger System • HiViz® Pro-Comp sight and ivory mid-bead **IDEAL USAGE** Skeet/Sporting Clays

C CITORI 725 TRAP D CITORI 725 TRAP WITH ADJUSTABLE COMB

RECEIVER Steel • Low-profile • Silver nitride finish • Gold accented engraving **BARREL** Ventilated top and side ribs • Ported **ACTION** Fire Lite Mechanical trigger system • Hammer ejectors • Top-tang barrel selector/safety **STOCK** Gloss finish Grade III/IV walnut with close radius pistol grip and palm swell • Monte Carlo cheekpiece or adjustable comb • Ventilated trap recoil pad • Semi-beavertail forearm with finger grooves **FEATURES** Vector Pro lengthened forcing cones • Three Invector-DS choke tubes • Triple Trigger System • HiViz® Pro-Comp sight and ivory mid-bead **IDEAL USAGE** Trap

	NEW 2015 GAUGE	CODE NUMBER	SUGGESTED RETAIL	BARREL LENGTH Inches	CHOKES Included	CHAMBER Inches	AVERAGE WEIGHT Lbs. / Oz.	OVERALL LENGTH Inches	DROP AT COMB Inches	DROP AT HEEL Inches	LENGTH OF PULL Inches	RIB WIDTH Inches
CITORI 725 SKEET												
A	12	0136163010	3,139.99	30	SK,SK,IC	3	7 / 11	48	1-3/4	1-3/4	14-3/8	3/8
	12	0136163011	3,139.99	28	SK,SK,IC	3	7 / 9	46	1-3/4	1-3/4	14-3/8	3/8
CITORI 725 SKEET WITH ADJUSTABLE COMB												
B	12	0136173010	3,529.99	30	SK,SK,IC	3	8 / 0	48	1-7/8 adj.	1-7/8 adj.	14-3/8	3/8
	12	0136173011	3,529.99	28	SK,SK,IC	3	7 / 14	46	1-7/8 adj.	1-7/8 adj.	14-3/8	3/8
CITORI 725 TRAP												
C	12	0135793009	3,339.99	32	F,IM,M	2-3/4	8 / 10	50	1-9/16	1-15/16	14-3/8	1/4-3/8
	12	0135793010	3,339.99	30	F,IM,M	2-3/4	8 / 7	48	1-9/16	1-15/16	14-3/8	1/4-3/8
CITORI 725 TRAP WITH ADJUSTABLE COMB												
D	12	0135803009	3,739.99	32	F,IM,M	2-3/4	8 / 11	50	1-11/16 adj.	1-15/16 adj.	14-3/8	1/4-3/8
	12	0135803010	3,739.99	30	F,IM,M	2-3/4	8 / 8	48	1-11/16 adj.	1-15/16 adj.	14-3/8	1/4-3/8



GO AFIELD WITH A CITORI 725.

A Browning Citori 725 Field gun is the match to a fast-moving pheasant climbing out of the corn and into the sky. Ruggedly beautiful and ready to shoulder in an instant, the 725 is the epitome of over and under excellence.

NEW 20 GAUGE



E CITORI 725 FEATHER



Feather 12 Gauge Engraving, Right



Feather 12 Gauge Engraving, Left



F CITORI 725 FIELD



Field 20 Gauge Engraving, Right



Field 20 Gauge Engraving, Left

E CITORI 725 FEATHER

RECEIVER Lightweight alloy with steel breech face and hinge pin • Low-profile (12 gauge) • Silver nitride finish • Accented, high-relief engraving **BARREL** Ventilated top rib **ACTION** Fire Lite Mechanical trigger system • Hammer ejectors • Top-tang barrel selector/safety **STOCK** Gloss oil finish Grade II/III walnut with close radius pistol grip • Inflex recoil pad **FEATURES** Vector Pro lengthened forcing cones • Three Invector-DS choke tubes • Ivory front and mid-bead sights **IDEAL USAGE** Hunting/Sporting Clays

F CITORI 725 FIELD

RECEIVER Steel • Low-profile (12 gauge) • Silver nitride finish • Accented, high-relief engraving **BARREL** Ventilated top rib **ACTION** Fire Lite Mechanical trigger system • Hammer ejectors • Top-tang barrel selector/safety **STOCK** Gloss oil finish Grade II/III walnut with close radius pistol grip • Inflex recoil pad **FEATURES** Vector Pro lengthened forcing cones • Three Invector-DS choke tubes • Ivory front and mid-bead sights **IDEAL USAGE** Hunting/Sporting Clays

	NEW 2015 GAUGE	CODE NUMBER	SUGGESTED RETAIL	BARREL LENGTH Inches	CHOKES Included	CHAMBER Inches	AVERAGE WEIGHT lbs./oz.	OVERALL LENGTH Inches	DROP AT COMB Inches	DROP AT HEEL Inches	LENGTH OF PULL Inches	RIB WIDTH Inches
CITORI 725 FEATHER												
E	12	0135663004	2,549.99	28	F,M,I,C	3	6 / 9	45-3/4	1-5/8	2-1/2	14-1/4	1/4
	12	0135663005	2,549.99	26	F,M,I,C	3	6 / 7	43-3/4	1-5/8	2-1/2	14-1/4	1/4
	• 20	0135666004	2,549.99	28	F,M,I,C	3	6 / 6	45-3/4	1-1/2	2-3/8	14-1/4	1/4
	• 20	0135666005	2,549.99	26	F,M,I,C	3	6 / 4	43-3/4	1-1/2	2-3/8	14-1/4	1/4
CITORI 725 FIELD												
	12	0135303004	2,469.99	28	F,M,I,C	3	7 / 6	45-3/4	1-5/8	2-1/2	14-1/4	1/4
	12	0135303005	2,469.99	26	F,M,I,C	3	7 / 4	43-3/4	1-5/8	2-1/2	14-1/4	1/4
F	20	0135306004	2,469.99	28	F,M,I,C	3	6 / 6	45-3/4	1-1/2	2-3/8	14-1/4	1/4
	20	0135306005	2,469.99	26	F,M,I,C	3	6 / 4	43-3/4	1-1/2	2-3/8	14-1/4	1/4



HAND-FINISHED RELIABILITY.

Every Browning Citori is fitted, polished and assembled by hand, achieving a level of perfection that rivals guns often costing much more. The extra attention to detail assures smooth operation and flawless looks, while adding longevity and integrity to a gun so it's ready for the next generation.

Citori®



TRIPLE TRIGGER SYSTEM

Citori target shotguns come equipped with the Triple Trigger System, which fine tunes finger-to-trigger length of pull. Choose a wide checkered, narrow smooth or wide smooth canted trigger shoe.



LOCKING BOLT AND HINGE PIN

The Citori features a heavy-duty, transverse-mounted, full-width tapered locking bolt that engages a full-width tapered recess in the rear barrel lugs. Tapering the bolt and recess allows the bolt to seat deeper, accommodating for wear. The hinge pin extends across the width of the receiver for maximum strength. Engineering like this ensures the Citori wears in, not out.



Browning pattern with Back-Bored Technology

The competitors' pattern without Back-Bored Technology

CHROME CHAMBERS

For increased durability and corrosion resistance, all Citori shotguns have hard chrome-plated chambers to resist the toll that thousands of shells can take on lesser quality guns.



STEEL SHOT PERFORMANCE

The strength of Browning barrels is legendary, and built to handle the punishment of steel shot. Unlike some manufacturers' barrels that show pitting after shooting steel, Browning pioneered construction that maximizes steel shot performance and barrel durability. Browning barrels meet the strictest material and construction quality standards. The barrel blanks are made from rolled and tempered steel bars and are stress relieved to offer exceptional mechanical properties. The barrel blanks are then precision drilled, reamed and honed to exacting specifications. With proper care, Browning Citori barrels will last a lifetime.

HAMMERS AND HAMMER EJECTORS

For positive primer ignition, Citori hammers are driven by powerful coil-type mainsprings. The convenient barrel selector allows a shooter to choose which barrel fires on the first pull of the single trigger, and the second pull fires the remaining barrel. Ejectors are fired by a sharp hammer blow for more positive ejection than the push imparted by competitors' ejectors. The automatic ejectors eject fired hulls when the breech is opened and elevate unfired shells for easy removal.

VECTORPRO™

VECTOR PRO LENGTHENED FORCING CONES ON 12 AND 20 GAUGE CITORI SHOTGUNS

Browning was the first manufacturer to recognize the performance advantages of a back-bored barrel and to make it a standard feature on shotguns.

Longer, tapered Vector Pro forcing cone dimensions minimize shot deformation and maximize pattern uniformity, consistency and density.

Back-boring increases bore diameter specifications and decreases friction between the shot cup and the bore to maximize shot pellet velocity and to reduce felt recoil. Reducing constriction from the forcing cone on the shot column results in fewer deformed pellets for more uniform patterns, and keeps more pellets in the central part of the pattern where they're needed to bag more upland birds, waterfowl and clay targets. Browning back-bore specifications represent the ideal bore dimensions. A larger bore diameter can let gases slip by the shot cup, resulting in both reduced pellet velocity and blown patterns. A smaller bore diameter means the forcing cone can deform pellets, leading to flyers and poor ballistic performance.

INVECTOR CHOKE TUBE SYSTEMS

The proven Standard Invector (28 gauge, .410 bore) or Invector-Plus (12, 20 gauge) interchangeable choke tube systems are featured on every Citori shotgun and provide consistent, dense shot patterns in the constriction needed for the specific shooting situation. The longer choke taper inside an Invector-Plus choke tube works with back-bored barrels and Vector Pro lengthened forcing cones to produce dense patterns with uniform densities and fewer flyers. The superior designs of the Invector systems are far more durable than the choke systems found in competitors' guns, especially when shooting steel shot loads. The Invector systems eliminate gases slipping between the choke tube and barrel that could damage both the choke tube and the barrel. See pages 144 to 149 for a complete listing of choke tubes.



A CITORI LIGHTNING

Lightning Engraving, Right



B CITORI WHITE LIGHTNING

White Lightning Engraving, Right



C CITORI MICRO MIDAS

A CITORI LIGHTNING B CITORI WHITE LIGHTNING

RECEIVER Steel • High-relief engraving • Blued finish on Lightning • Silver Nitride finish on White Lightning **BARREL** Ventilated rib **ACTION** Single selective trigger • Hammer ejectors • Top-tang barrel selector/safety **STOCK** Lightning-style stock and forearm • Gloss finish • Grade I/II walnut on Lightning • Grade II/III on White Lightning **FEATURES** Vector Pro lengthened forcing cones on 12 and 20 • Three Invector-Plus choke tubes with 12 and 20 • Three Standard Invector choke tubes with 28 and .410 • Recoil pad on 12 gauge model • Silver front bead sight **IDEAL USAGE** Hunting/Sporting Clays

C CITORI MICRO MIDAS

RECEIVER Steel • Blued finish **BARREL** Ventilated rib **ACTION** Single selective trigger • Hammer ejectors • Top-tang barrel selector/safety **STOCK** Satin finish walnut • Compact stock with 13" length of pull **FEATURES** Vector Pro lengthened forcing cones • Three Invector-Plus choke tubes • Ventilated recoil pad • Silver front bead sight **IDEAL USAGE** Hunting/Sporting Clays **ELIGIBLE FOR THE GROWTH INSURANCE PROGRAM** See page 2 for details.

	NEW 2015	GAUGE / BORE	CODE NUMBER	SUGGESTED RETAIL	BARREL LENGTH Inches	CHOKES Included	CHAMBER Inches	AVERAGE WEIGHT Lbs. / Oz.	OVERALL LENGTH Inches	DROP AT COMB Inches	DROP AT HEEL Inches	LENGTH OF PULL Inches	RIB WIDTH Inches
CITORI LIGHTNING													
		12	013461304	1,989.99	28	F,M,IC	3	8 / 2	45	1-5/8	2-1/2	14-1/4	5/16
		12	013461305	1,989.99	26	F,M,IC	3	8 / 0	43	1-5/8	2-1/2	14-1/4	5/16
A		20	013461604	1,989.99	28	F,M,IC	3	6 / 9	45	1-1/2	2-3/8	14-1/4	1/4
		20	013461605	1,989.99	26	F,M,IC	3	6 / 7	43	1-1/2	2-3/8	14-1/4	1/4
		28	013461813	2,069.99	28	F,M,IC	2-3/4	6 / 12	45	1-1/2	2-3/8	14-1/4	1/4
		28	013461814	2,069.99	26	F,M,IC	2-3/4	6 / 10	43	1-1/2	2-3/8	14-1/4	1/4
		.410	013461913	2,069.99	28	F,M,IC	3	6 / 10	45	1-1/2	2-3/8	14-1/4	1/4
		.410	013461914	2,069.99	26	F,M,IC	3	6 / 8	43	1-1/2	2-3/8	14-1/4	1/4
CITORI WHITE LIGHTNING													
		12	013462304	2,069.99	28	F,M,IC	3	8 / 2	45	1-5/8	2-1/2	14-1/4	5/16
B		12	013462305	2,069.99	26	F,M,IC	3	8 / 0	43	1-5/8	2-1/2	14-1/4	5/16
		20	013462604	2,069.99	28	F,M,IC	3	6 / 9	45	1-1/2	2-3/8	14-1/4	1/4
		20	013462605	2,069.99	26	F,M,IC	3	6 / 7	43	1-1/2	2-3/8	14-1/4	1/4
		28	013462813	2,139.99	28	F,M,IC	2-3/4	6 / 12	45	1-1/2	2-3/8	14-1/4	1/4
		28	013462814	2,139.99	26	F,M,IC	2-3/4	6 / 10	43	1-1/2	2-3/8	14-1/4	1/4
		.410	013462913	2,139.99	28	F,M,IC	3	6 / 10	45	1-1/2	2-3/8	14-1/4	1/4
		.410	013462914	2,139.99	26	F,M,IC	3	6 / 8	43	1-1/2	2-3/8	14-1/4	1/4
CITORI MICRO MIDAS													
		12	013497305	1,649.99	26	F,M,IC	3	7 / 12	41-3/4	1-5/8	2-1/2	13	5/16
C		12	013497306	1,649.99	24	F,M,IC	3	7 / 10	39-3/4	1-5/8	2-1/2	13	5/16
		20	013497605	1,649.99	26	F,M,IC	3	6 / 1	41-3/4	1-1/2	2-3/8	13	1/4
		20	013497606	1,649.99	24	F,M,IC	3	5 / 15	39-3/4	1-1/2	2-3/8	13	1/4





A CITORI FEATHER LIGHTNING

Feather Lightning Engraving, Right



B CITORI SUPERLIGHT FEATHER

Superlight Feather Engraving, Bottom



C CITORI LIGHTNING FEATHER COMBO



Traditional fitted case included with Lightning Feather Combo.

A CITORI FEATHER LIGHTNING

RECEIVER Lightweight alloy with steel breech face and hinge pin • High-relief engraving **BARREL** Ventilated rib **ACTION** Single selective trigger • Hammer ejectors • Top-tang barrel selector/safety **STOCK** Gloss oil finish Grade II/III walnut • Lightning-style stock and forearm **FEATURES** Vector Pro lengthened forcing cones • Three Invector-Plus choke tubes • Recoil pad on 12 gauge model • Silver front bead sight **IDEAL USAGE** Hunting/Sporting Clays

B CITORI SUPERLIGHT FEATHER

RECEIVER Lightweight alloy with steel breech face and hinge pin • High-relief engraving **BARREL** Ventilated rib **ACTION** Single selective trigger • Hammer ejectors • Top-tang barrel selector/safety **STOCK** Gloss finish walnut • English-style straight grip stock • Schnabel forearm **FEATURES** Vector Pro lengthened forcing cones • Three Invector-Plus choke tubes • Silver front bead sight **IDEAL USAGE** Hunting/Sporting Clays

C CITORI LIGHTNING FEATHER COMBO

RECEIVER Lightweight alloy with steel breech face and hinge pin • High-relief engraving **BARREL** Combo includes 3" chambered 20 gauge and 2-3/4" chambered 28 gauge barrels in 27" length • Ventilated rib **ACTION** Single selective trigger • Hammer ejectors • Top-tang barrel selector/safety **STOCK** Gloss finish walnut • Lightning-style stock and forearm **FEATURES** Vector Pro lengthened forcing cones on 20 gauge barrels • Three Invector-Plus 20 gauge choke tubes • Three Standard Invector 28 gauge choke tubes • Silver front bead sight • Traditional fitted case included **IDEAL USAGE** Hunting/Sporting Clays

NEW 2015	GAUGE	CODE NUMBER	SUGGESTED RETAIL	BARREL LENGTH Inches	CHOKES Included	CHAMBER Inches	AVERAGE WEIGHT lbs. / oz.	OVERALL LENGTH Inches	DROP AT COMB Inches	DROP AT HEEL Inches	LENGTH OF PULL Inches	RIB WIDTH Inches
CITORI FEATHER LIGHTNING												
	12	013554304	2,179.99	28	F,M,IC	3	7 / 2	45	1-5/8	2-1/2	14-1/4	1/4
	12	013554305	2,179.99	26	F,M,IC	3	7 / 0	43	1-5/8	2-1/2	14-1/4	1/4
A	20	013554604	2,179.99	28	F,M,IC	3	6 / 0	45	1-1/2	2-3/8	14-1/4	1/4
	20	013554605	2,179.99	26	F,M,IC	3	5 / 14	43	1-1/2	2-3/8	14-1/4	1/4
CITORI SUPERLIGHT FEATHER												
	12	013055405	2,389.99	26	F,M,IC	2-3/4	6 / 4	43	1-5/8	2-1/2	14-1/4	1/4
B	20	013055705	2,389.99	26	F,M,IC	2-3/4	5 / 11	43	1-1/2	2-3/8	14-1/4	7/32
CITORI LIGHTNING FEATHER COMBO												
C	20/28	013064735	3,579.99	27	F,M,IC	3 & 2-3/4	6 / 3	44	1-1/2	2-3/8	14-1/4	1/4



PREMIUM VALUE.

The Browning Citori XT is a legend among trap shooters for its long-term reliability, achieved from using a full width steel hinge pin (not simply a pair of trunnions) and a tapered locking lug that seats deeper with wear. No wonder people say that through the years a Citori wears in, not out.



D CITORI XT TRAP, GRADE I



E CITORI XT TRAP, GRADE I WITH ADJUSTABLE COMB



XT Trap Engraving, Right

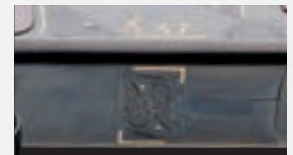

XT Trap Engraving, Bottom

D CITORI XT TRAP, GRADE I

RECEIVER Steel • Blued finish • Gold accented, high-relief engraving **BARREL** Ventilated top and side ribs • Tapered, floating high-post top rib • Ported **ACTION** Single selective trigger • Hammer ejectors • Top-tang barrel selector/safety **STOCK** Gloss finish Grade II/III walnut with right-hand palm swell • Ventilated trap recoil pad • Semi-beavertail forearm with finger grooves **FEATURES** Vector Pro lengthened forcing cones • Three Invector-Plus choke tubes • Triple Trigger System • HiViz® Pro-Comp sight • Mid-bead sight **IDEAL USAGE** Trap

E CITORI XT TRAP, GRADE I WITH ADJUSTABLE COMB

RECEIVER Steel • Blued finish • Gold accented, high-relief engraving **BARREL** Ventilated top and side ribs • Tapered, floating high-post top rib • Ported **ACTION** Single selective trigger • Hammer ejectors • Top-tang barrel selector/safety **STOCK** Gloss finish Grade II/III walnut with right-hand palm swell • Adjustable comb • Ventilated trap recoil pad • Semi-beavertail forearm with finger grooves **FEATURES** Vector Pro lengthened forcing cones • Three Invector-Plus choke tubes • Triple Trigger System • HiViz® Pro-Comp sight • Mid-bead sight **IDEAL USAGE** Trap

NEW 2015	GAUGE	CODE NUMBER	SUGGESTED RETAIL	BARREL LENGTH Inches	CHOKES Included	CHAMBER Inches	AVERAGE WEIGHT lbs./ Oz.	OVERALL LENGTH Inches	DROP AT COMB Inches	DROP AT HEEL Inches	LENGTH OF PULL Inches	RIB WIDTH Inches
CITORI XT TRAP, GRADE I												
	12	013620427	2,649.99	32	F,F,IM	2-3/4	8 / 8	49	1-9/16	2	14-3/8	1/4-3/8
D	12	013620426	2,649.99	30	F,F,IM	2-3/4	8 / 6	47	1-9/16	2	14-3/8	1/4-3/8
CITORI XT TRAP, GRADE I WITH ADJUSTABLE COMB												
	12	013621427	2,999.99	32	F,F,IM	2-3/4	8 / 13	49	1-11/16 adj.	1-15/16 adj.	14-3/8	1/4-3/8
E	12	013621426	2,999.99	30	F,F,IM	2-3/4	8 / 11	47	1-11/16 adj.	1-15/16 adj.	14-3/8	1/4-3/8



CYNERGY SHOTGUNS.
Loaded with high performance features.

CYNERGY®

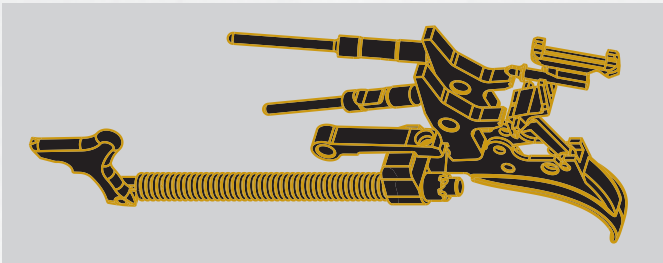

REVERSE STRIKER MECHANICAL TRIGGER

- The Reverse Striker is a striker-based, mechanical trigger system that does not use the inertia from recoil to set the hammers.
- Reverse Striker offers the benefits of a crisp feel, reduced locktime and less overtravel than other over and under shotguns.
- Because inertia is not needed for the hammers to set, the design eliminates the possibility of the second barrel not firing.
- Cynergy target models are equipped with the Triple Trigger System, allowing finger to trigger length adjustment and the ability to switch between styles of trigger shoes: Wide checkered, narrow smooth or wide smooth canted.



MONOLOCK HINGE

- The strong MonoLock Hinge design is the engineering behind the Cynergy's low profile receiver.
- Integrates the monobloc and the hinge for up to 300% more surface area to pivot on than traditional trunnion-style hinges.
- Rectangular locking pins provide extra strength and feature a "Wear-In Relief" that keeps the action tight.

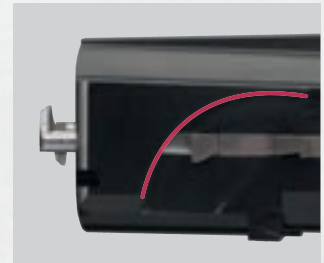

CHROME CHAMBERS

- Cynergy shotguns feature hard chrome-plated chambers.
- Increased durability and corrosion resistance.

IMPACT EJECTORS

- Impact Ejectors are aided by the punch of a secondary striker spring for positive, reliable ejection of fired hulls from the chambers.
- Unfired shells are elevated for easy removal.

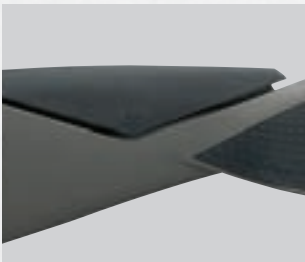

ADJUSTABLE COMB

- Composite models include an integrated, adjustable comb system that allows the gun to be easily customized.
- Drop at comb adjustments are made in 1/8" increments.
- For cast on/cast off customizing, we offer accessory combs that are shown below.

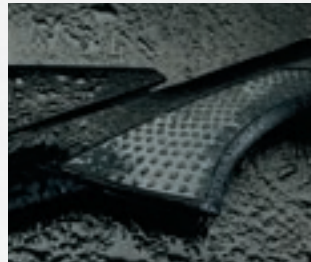

SUPERIOR GRIPPING SURFACES

- Composite Cynergy models combine molded-in rubberized textured gripping surfaces.



CYNERGY ACCESSORIES

RECOIL PADS FOR COMPOSITE GUNS



A



C

RECOIL PADS FOR WOOD GUNS



E

SPACERS

F



COMPOSITE MODEL ADJUSTABLE COMB

ALL BROWNING FIREARMS ARE SHIPPED WITH A FREE LOCKING DEVICE TO ASSIST IN THE SAFE STORAGE OF FIREARMS.

NEW 2015	DESCRIPTION	CODE NUMBER	SUGGESTED RETAIL
CYNERGY ACCESSORIES			
A	Short Composite Recoil Pad	11400	58.00
	Medium Composite Recoil Pad	11401	58.00
B	Long Composite Recoil Pad	11402	58.00
C	Short Wood Recoil Pad	11410	58.00
	Medium Wood Recoil Pad	11411	58.00
D	Long Wood Recoil Pad	11412	58.00
E	1/4" Composite Stock Spacer	11430	12.00
F	1/4" Wood Stock Spacer	11431	12.00
G	Cast-on Adj. Comb, Composite	11420	38.00
	Cast-off Adj. Comb, Composite	11421	38.00

Length of pull is adjustable from 13-1/4" - 15" with the recoil pads and stock spacers above. See page 2 for details on Inflex pads. All new guns ship with medium pads.

DESIGNED TO BE DIFFERENT.

The Browning Cynergy is designed to be the lowest profile over and under available, and also the strongest. The ultra low profile receiver reduces weight without sacrificing strength and helps control recoil, making the Cynergy easy on the shoulder.

NEW



H CYNERGY FIELD



Field 12 Gauge Engraving, Right



Field 12 Gauge Engraving, Left



Field 20, 28 Gauge and .410 Bore Engraving, Right



Field 20, 28 Gauge and .410 Bore Engraving, Left

NEW



I CYNERGY MICRO MIDAS



Micro Midas Engraving, Right



Micro Midas Engraving, Left

H CYNERGY FIELD

RECEIVER Steel • Silver nitride finish • Ultra-low profile • Engraved receiver **BARREL** Lightweight profile • Ventilated top and side ribs • Matte blued finish **ACTION** Reverse Striker ignition system • Impact Ejectors • Top-tang barrel selector/safety **STOCK** Satin varnish finish • Grade 1/II walnut • Inflex recoil pad **FEATURES** Vector Pro lengthened forcing cones on 12 and 20 • Three Invector-Plus choke tubes with 12 and 20 • Three Standard Invector choke tubes with 28 and .410 • 1/4" stock spacer • Ivory front bead sight **IDEAL USAGE** Hunting/Sporting Clays

I CYNERGY MICRO MIDAS

RECEIVER Steel • Silver nitride finish • Ultra-low profile • MonoLock Hinge • Engraved receiver **BARREL** Lightweight profile • Ventilated top and side ribs • Matte blued finish **ACTION** Reverse Striker ignition system • Impact Ejectors • Top-tang barrel selector/safety **STOCK** Satin varnish finish • Grade 1/II walnut • Inflex recoil pad • Compact 13" length of pull **FEATURES** Vector Pro lengthened forcing cones • Three Invector-Plus choke tubes • Three 1/4" stock spacers • Ivory front bead sight **IDEAL USAGE** Hunting/Sporting Clays **ELIGIBLE FOR THE GROWTH INSURANCE PROGRAM** See page 2 for details.

	NEW 2015	GAUGE / BORE	CODE NUMBER	SUGGESTED RETAIL	BARREL LENGTH Inches	CHOKES Included	CHAMBER Inches	AVERAGE WEIGHT lbs. / Oz.	OVERALL LENGTH Inches	DROP AT COMB Inches	DROP AT HEEL Inches	LENGTH OF PULL Inches	RIB WIDTH Inches
CYNERGY FIELD													
H	• 12	018706304	1,869.99	28	F,M,IC	3	7 / 11	45	1-5/8	2	14-1/4	5/16	
	• 12	018706305	1,869.99	26	F,M,IC	3	7 / 9	43	1-5/8	2	14-1/4	5/16	
	• 20	018706604	1,939.99	28	F,M,IC	3	6 / 4	45	1-5/8	2	14-1/4	7/32	
	• 20	018706605	1,939.99	26	F,M,IC	3	6 / 2	43	1-5/8	2	14-1/4	7/32	
	• 28	018706813	1,939.99	28	F,M,IC	2-3/4	6 / 4	45	1-5/8	2	14-1/4	7/32	
	• 28	018706814	1,939.99	26	F,M,IC	2-3/4	6 / 2	43	1-5/8	2	14-1/4	7/32	
	• .410	018706913	1,939.99	28	F,M,IC	3	6 / 1	45	1-5/8	2	14-1/4	7/32	
	• .410	018706914	1,939.99	26	F,M,IC	3	5 / 15	43	1-5/8	2	14-1/4	7/32	
CYNERGY MICRO MIDAS													
I	• 20	018701605	1,869.99	26	F,M,IC	3	6 / 2	43-3/4	1-5/8	2	13	7/32	
	• 20	018701606	1,869.99	24	F,M,IC	3	6 / 0	41-3/4	1-5/8	2	13	7/32	



FEATHERWEIGHTS.

A lightweight, ultra-low profile alloy receiver makes carrying a Cynergy Feather a joy. But over time its weight — or lack of weight — is most noticeable when it is pulled to the shoulder and swung onto a fast-moving target.

NEW

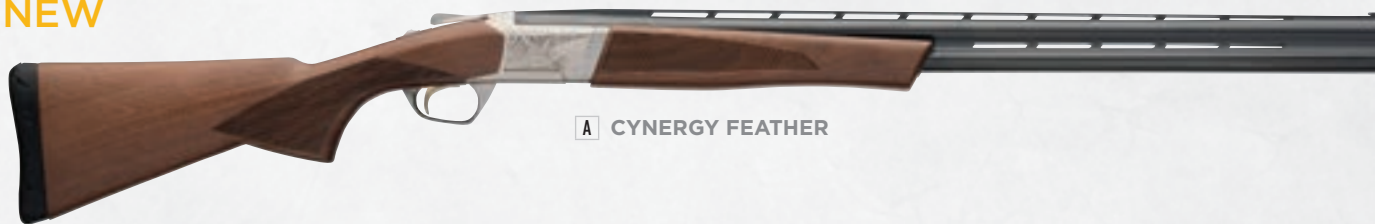

A CYNERGY FEATHER

NEW

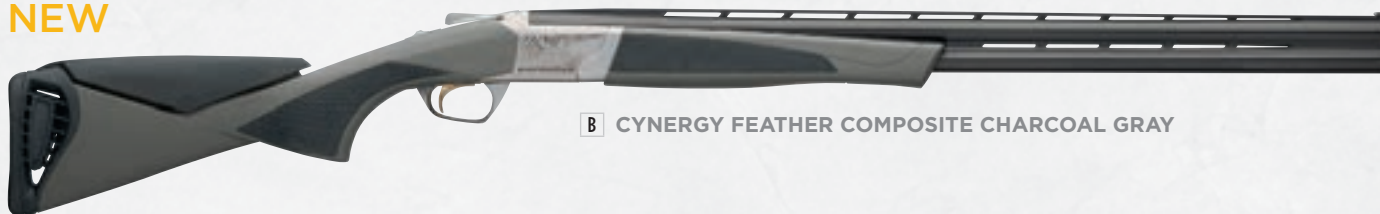

B CYNERGY FEATHER COMPOSITE CHARCOAL GRAY

A CYNERGY FEATHER

RECEIVER Lightweight alloy with steel breech face • Ultra-low profile • MonoLock Hinge • Engraved receiver **BARREL** Lightweight profile • Ventilated top and side ribs • Matte blued finish **ACTION** Reverse Striker ignition system • Impact Ejectors • Top-tang barrel selector/safety **STOCK** Satin varnish finish • Grade I/II walnut • Inflex recoil pad **FEATURES** Vector Pro lengthened forcing cones • Three Invector-Plus choke tubes • 1/4" stock spacer • Ivory front bead sight **IDEAL USAGE** Hunting/Sporting Clays

B CYNERGY FEATHER COMPOSITE CHARCOAL GRAY

RECEIVER Lightweight alloy with steel breech face • Gold enhanced grayed finish • Ultra-low profile • MonoLock Hinge • Engraved receiver **BARREL** Lightweight profile • Ventilated top and side ribs • Matte blued finish **ACTION** Reverse Striker ignition system • Impact Ejectors • Top-tang barrel selector/safety **STOCK** Charcoal gray composite with black rubber overmolding in grip areas • Adjustable comb **FEATURES** Vector Pro lengthened forcing cones • Three Invector-Plus choke tubes • Inflex recoil pad • 1/4" stock spacer • Ivory front bead sight **IDEAL USAGE** Hunting/Sporting Clays

NEW 2015	GAUGE	CODE NUMBER	SUGGESTED RETAIL	BARREL LENGTH Inches	CHOKES Included	CHAMBER Inches	AVERAGE WEIGHT lbs. / Oz.	OVERALL LENGTH Inches	DROP AT COMB Inches	DROP AT HEEL Inches	LENGTH OF PULL Inches	RIB WIDTH Inches
CYNERGY FEATHER												
A •	12	018703304	2,139.99	28	F,M,IC	3	6 / 12	45	1-5/8	2	14-1/4	5/16
•	12	018703305	2,139.99	26	F,M,IC	3	6 / 10	43	1-5/8	2	14-1/4	5/16
•	20	018703604	2,199.99	28	F,M,IC	3	5 / 12	45	1-5/8	2	14-1/4	5/16
•	20	018703605	2,199.99	26	F,M,IC	3	5 / 10	43	1-5/8	2	14-1/4	5/16
CYNERGY FEATHER COMPOSITE CHARCOAL GRAY												
B •	12	018702304	2,069.99	28	F,M,IC	3	7 / 11	45	1-5/8	2	14-1/4	5/16
•	12	018702305	2,069.99	26	F,M,IC	3	7 / 9	43	1-5/8	2	14-1/4	5/16



NEW



C CYNERGY SPORTING

NEW



D CYNERGY SPORTING WITH ADJUSTABLE COMB

NEW

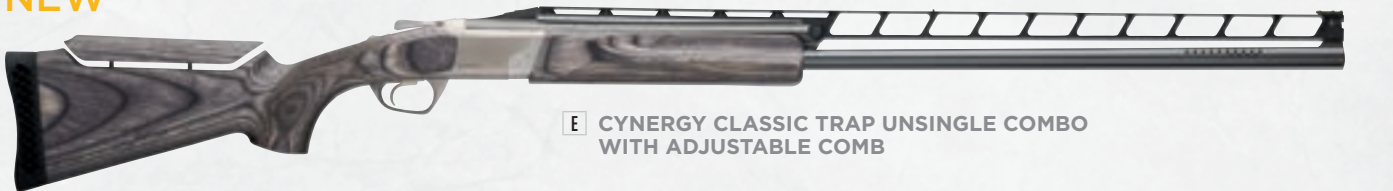

E CYNERGY CLASSIC TRAP UNSINGLE COMBO WITH ADJUSTABLE COMB



Canvas/Leather fitted case included with every Cynergy Trap Unsingle Combo.

C CYNERGY SPORTING D CYNERGY SPORTING WITH ADJUSTABLE COMB

RECEIVER Steel • Silver nitride finish • Ultra-low profile • MonoLock Hinge • Engraved receiver **BARREL** Lightweight profile • Ventilated top and side ribs • Ported • Matte blued finish **ACTION** Reverse Striker ignition system • Impact Ejectors • Top-tang barrel selector/safety **STOCK** Satin varnish finish • Grade I/II walnut • Inflex recoil pad • Available with adjustable comb **FEATURES** Vector Pro lengthened forcing cones • Three Invector-Plus Midas Grade choke tubes • Adjustable length of pull trigger • 1/4" stock spacer • HiViz® Pro-Comp fiber-optic sight • Ivory mid-bead sight **IDEAL USAGE** Skeet/Sporting Clays

E CYNERGY CLASSIC TRAP UNSINGLE COMBO WITH ADJUSTABLE COMB

RECEIVER Steel • Silver nitride finish • Ultra-low profile • MonoLock Hinge • Engraved receiver **BARREL** Double and Unsingle barrel sets included • Lightweight profile over and under barrel set • Single barrel set features an adjustable rib for fine-tuning of rib angle for sight picture and point of impact • Ported • Matte blued finish **ACTION** Reverse Striker ignition system • Impact Ejectors • Top-tang barrel selector/safety **STOCK** Gray laminated Monte Carlo stock with right-hand palm swell • Adjustable comb • Modified semi-beavertail forearm with finger grooves **FEATURES** Vector Pro lengthened forcing cones • Four Invector-Plus Midas Grade choke tubes • Adjustable length of pull trigger • HiViz® Pro-Comp fiber-optic sight • Ivory mid-bead sight • Green canvas/leather fitted case with Cynergy logo **IDEAL USAGE** Trap

NEW 2015	GAUGE	CODE NUMBER	SUGGESTED RETAIL	BARREL LENGTH Inches	CHOKES Included	CHAMBER Inches	AVERAGE WEIGHT Lbs. / Oz.	OVERALL LENGTH Inches	DROP AT COMB Inches	DROP AT HEEL Inches	LENGTH OF PULL Inches	RIB WIDTH Inches
CYNERGY SPORTING												
C	12	018704326	2,399.99	32	M,IC,SK	3	8 / 0	50	1-5/8	2	14-1/4	5/16-7/16
		018704327	2,399.99	30	M,IC,SK	3	7 / 14	48	1-5/8	2	14-1/4	5/16-7/16
D CYNERGY SPORTING WITH ADJUSTABLE COMB												
D	12	018705326	2,669.99	32	M,IC,SK	3	8 / 6	50	1-5/8 adj.	2 adj.	14-1/4	5/16-7/16
	12	018705327	2,669.99	30	M,IC,SK	3	8 / 4	48	1-5/8 adj.	2 adj.	14-1/4	5/16-7/16
E CYNERGY CLASSIC TRAP UNSINGLE COMBO WITH ADJUSTABLE COMB												
	12	018707479	4,269.99	32/34	F,F,F,IM	2-3/4	8 / 15	48-1/4 • 50-1/4	1-1/16 adj.	2 adj.	14-3/8	1/4-3/8
	12	018707469	4,269.99	32/32	F,F,F,IM	2-3/4	8 / 15	48-1/4	1-1/16 adj.	2 adj.	14-3/8	1/4-3/8
	12	018707468	4,269.99	30/34	F,F,F,IM	2-3/4	8 / 13	46-1/4 • 50-1/4	1-1/16 adj.	2 adj.	14-3/8	1/4-3/8



MORE POPULAR THAN EVER.

Trap shooting is a challenging discipline that requires tremendous focus and plenty of practice. Having a specialized gun like the fast swinging BT-99 is a big advantage when taking a shot at victory.

BT99



FOREARM

- A beavertail forearm helps control recoil and assists hand-eye coordination.

RIB

- High-post, 11/32" rib offers natural sighting and target acquisition.



CHROME CHAMBER

- The chrome-plated chamber resists wear and corrosion.

ALL BROWNING FIREARMS ARE SHIPPED WITH A FREE LOCKING DEVICE TO ASSIST IN THE SAFE STORAGE OF FIREARMS.



A BT-99 GOLDEN CLAYS



Golden Clays Engraving, Right

NEW



B BT-99 PLUS



Plus Engraving, Right

A BT-99 GOLDEN CLAYS

RECEIVER Steel • Silver nitride finish • Gold accented, high-relief engraving **BARREL** High-post ventilated rib • Ported **ACTION** Extractor only **STOCK** Gloss finish Grade V/VI walnut • Ventilated trap recoil pad • Beavertail forearm **FEATURES** Vector Pro lengthened forcing cone • Three Invector-Plus choke tubes • Adjustable straight comb • Adjustable GraCoil® recoil reduction system • Ivory front and mid-bead sights **IDEAL USAGE** Trap

B BT-99 PLUS

RECEIVER Steel • Polished blued finish • High-relief engraving **BARREL** High-post ventilated rib • Ported **ACTION** Ejector only **STOCK** Gloss oil finish Grade III/IV walnut • Pachmayr® Decelerator XLT recoil pad • Modified beavertail forearm **FEATURES** Vector Pro lengthened forcing cone • One Midas Grade Invector-Plus choke tube • Adjustable straight comb • Ivory front and mid-bead sights **IDEAL USAGE** Trap

NEW 2015	GAUGE	CODE NUMBER	SUGGESTED RETAIL	BARREL LENGTH Inches	CHOKES Included	CHAMBER Inches	AVERAGE WEIGHT Lbs. / Oz.	OVERALL LENGTH Inches	DROP AT COMB Inches	DROP AT HEEL Inches	LENGTH OF PULL Inches	RIB WIDTH Inches
BT-99 GOLDEN CLAYS												
	12	017057401	4,339.99	34	F,IM,M	2-3/4	9 / 0	51	1-9/16 adj.	1-3/4 adj.	13-3/8 - 14-3/8	11/32
A	12	017057402	4,339.99	32	F,IM,M	2-3/4	8 / 15	49	1-9/16 adj.	1-3/4 adj.	13-3/8 - 14-3/8	11/32
BT-99 PLUS												
B	• 12	017080401	2,939.99	34	IM	2-3/4	8 / 7	51	1-1/4 adj.	2 adj.	14-3/8	11/32
	• 12	017080402	2,939.99	32	IM	2-3/4	8 / 6	49	1-1/4 adj.	2 adj.	14-3/8	11/32



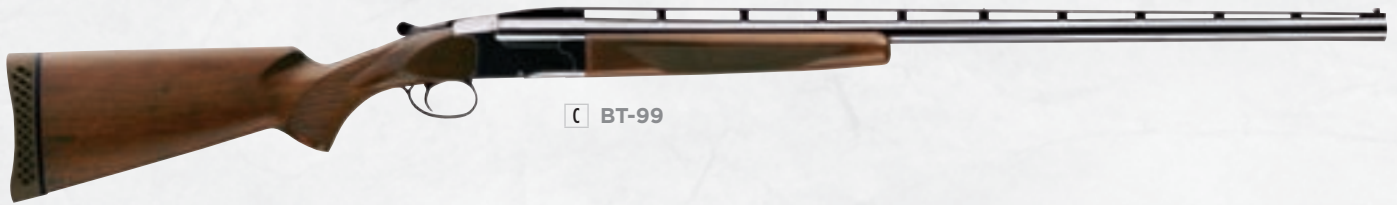

C BT-99

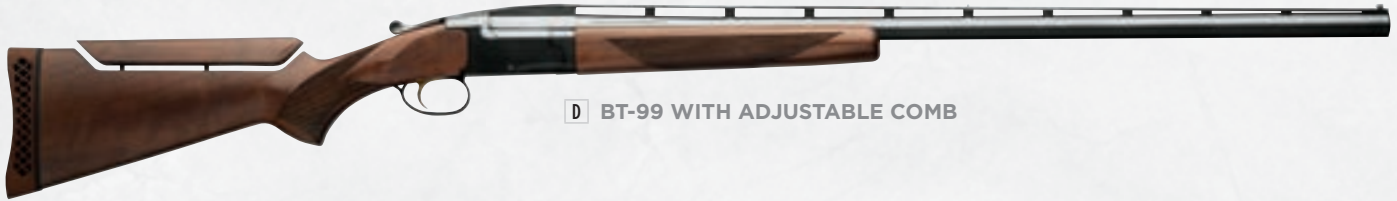

D BT-99 WITH ADJUSTABLE COMB

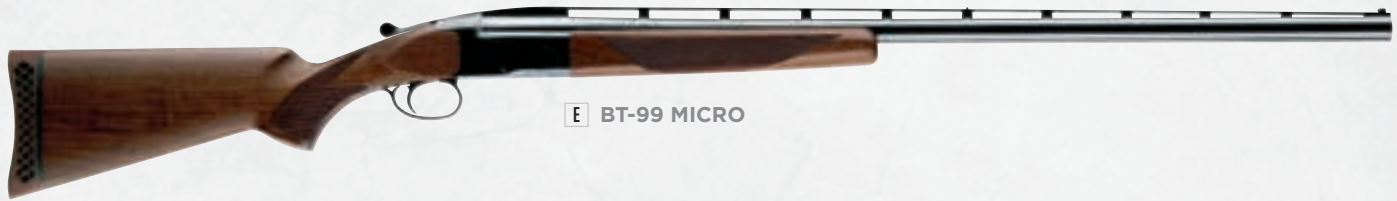

E BT-99 MICRO



F BT-99 MICRO MIDAS

C BT-99 **D BT-99 WITH ADJUSTABLE COMB**

RECEIVER Steel • Blued finish **BARREL** High-post ventilated rib **ACTION** Extractor only **STOCK** Satin finish walnut • Ventilated trap recoil pad • Available with adjustable comb • Beavertail forearm
FEATURES Vector Pro lengthened forcing cone • One Invector-Plus choke tube • Ivory front and mid-bead sights **IDEAL USAGE** Trap

E BT-99 MICRO **F BT-99 MICRO MIDAS**

RECEIVER Steel • Blued finish **BARREL** High-post ventilated rib **ACTION** Extractor only **STOCK** Satin finish walnut • Ventilated trap recoil pad • Beavertail forearm • Scaled down to comfortably fit smaller shooters **FEATURES** Vector Pro lengthened forcing cone • One Invector-Plus choke tube • Ivory front and mid-bead sights **IDEAL USAGE** Trap **ELIGIBLE FOR THE GROWTH INSURANCE PROGRAM** See page 2 for details.

	NEW 2015 GAUGE	CODE NUMBER	SUGGESTED RETAIL	BARREL LENGTH Inches	CHOKES Included	CHAMBER Inches	AVERAGE WEIGHT lbs. / Oz.	OVERALL LENGTH Inches	DROP AT COMB Inches	DROP AT HEEL Inches	LENGTH OF PULL Inches	RIB WIDTH Inches
BT-99												
C	12	017054401	1,429.99	34	Full	2-3/4	8 / 5	51	1-7/16	1-5/8	14-3/8	11/32
	12	017054402	1,429.99	32	Full	2-3/4	8 / 4	49	1-7/16	1-5/8	14-3/8	11/32
BT-99 WITH ADJUSTABLE COMB												
D	12	017055401	1,679.99	34	Full	2-3/4	8 / 5	51	1-9/16 adj.	1-3/4 adj.	14-3/8	11/32
	12	017055402	1,679.99	32	Full	2-3/4	8 / 4	49	1-9/16 adj.	1-3/4 adj.	14-3/8	11/32
BT-99 MICRO												
E	12	017061402	1,429.99	32	Full	2-3/4	7 / 13	48-1/2	1-7/16	1-5/8	13-3/4	11/32
	12	017061403	1,429.99	30	Full	2-3/4	7 / 12	46-1/2	1-7/16	1-5/8	13-3/4	11/32
BT-99 MICRO MIDAS												
F	12	017075403	1,429.99	30	IM	2-3/4	7 / 12	45-3/4	1-7/16	1-5/8	13	11/32
	12	017075404	1,429.99	28	IM	2-3/4	7 / 11	45-3/4	1-7/16	1-5/8	13	11/32



A5 — TRADITION AND TECHNOLOGY COLLIDE.

The familiar silhouette of a humpbacked Browning A5 may bring back memories, but this is not the Browning you grew up with. Built with cutting edge design and features, the A5 is ready to be the shotgun the next generation so fondly remembers.



ERGO BALANCED

- Incredibly balanced in the hands from pad to muzzle.
- Facilitates a light feel and fast swing.
- Promotes smoother follow through.
- Places front hand closer to the bore line for superior hand eye coordination and pointability.



TURNKEY MAGAZINE PLUG

- The patented TurnKey Magazine Plug is easily removed in seconds using a car key.



GET THE HUMPBACK ACQUISITION ADVANTAGE

- Extends the sight plane for faster, more natural sight alignment.
- Speeds target acquisition.



KINEMATIC DRIVE SYSTEM

- Kinetic energy is defined as the energy of motion.
- The A5 uses kinetic energy to power the recoil-operated Kinematic Drive System.
- Simplicity of design for consistent, reliable function with any load and under the full extremes of weather, temperature, moisture and grime.
- Kinematic Drive is so reliable that the A5 is the first ever autoloading shotgun to carry a 100,000-round or five-year guarantee – come hell or high water.
- Clean operation because gases are sent out the barrel and away from the action.
- Extreme load versatility for reliable performance with virtually all loads down to one ounce field with no adjustments.



SPEED LOAD PLUS

- Patented feeding system sends the first shell loaded into the magazine directly into the chamber.
- Speed Unload feature makes emptying the magazine fast and easy, without chambering and ejecting every shell with the bolt handle.



ABS CASE INCLUDED

- Sturdy ABS case is perfect for storing the A5.
- Lockable.

100,000
ROUND GUARANTEE
OR FIVE YEARS



ERGONOMIC BOLT LATCH

- Conveniently located just ahead of the trigger guard.
- Locks the bolt to the rear when the magazine is unloaded and releases a shell from the magazine when the bolt is closed for faster loading.
- Oversized shape makes the bolt latch easy to locate and operate with or without gloves.

ALL BROWNING FIREARMS ARE SHIPPED WITH A FREE LOCKING DEVICE TO ASSIST IN THE SAFE STORAGE OF FIREARMS.



A A5 ULTIMATE

RECEIVER Strong, lightweight aluminum alloy • Satin finish with brushed accents • Engraving pattern depicts pheasants on the left side and mallards on the right side, all surrounded by intricate scrollwork **BARREL** Lightweight profile • Flat, ventilated rib • Gloss blued finish **ACTION** 3" chamber • Recoil-operated Kinematic Drive **STOCK** Gloss oil finish walnut with close radius pistol grip • Sharp 22 lines-per-inch checkering • Shim adjustable for length of pull, cast and drop • 1/4" and 1/2" stock spacers for length of pull adjustment **FEATURES** Vector Pro lengthened forcing cone • Three Invector-DS choke tubes • Inflex recoil pad • Fiber-optic front sight • Ivory mid-bead sight • Includes ABS case **IDEAL USAGE** Hunting/Sporting Clays

NEW 2015	GAUGE	CODE NUMBER	SUGGESTED RETAIL	BARREL LENGTH Inches	CHOKES Included	CHAMBER Inches	AVERAGE WEIGHT Lbs. / Oz.	OVERALL LENGTH Inches	DROP AT COMB Inches	DROP AT HEEL Inches	LENGTH OF PULL Inches / Adjustable	RIB WIDTH Inches
A5 ULTIMATE												
A	12	0118203004	1,989.99	28	F,M,IC	3	6 / 11	49-5/8	1-3/4	2	14-1/4	1/4
	12	0118203005	1,989.99	26	F,M,IC	3	6 / 11	47-5/8	1-3/4	2	14-1/4	1/4





B A5 HUNTER

C A5 STALKER

D A5, MOSSY OAK® SHADOW GRASS BLADES

E A5, MOSSY OAK® BREAK-UP COUNTRY®

NEW CAMO

B A5 HUNTER

RECEIVER Strong, lightweight aluminum alloy • Black anodized bi-tone finish **BARREL** Lightweight profile • Flat, ventilated rib **ACTION** 3" and 3-1/2" chamber models • Recoil-operated Kinematic Drive **STOCK** Gloss finish walnut with close radius pistol grip • Sharp 18 lines-per-inch checkering • Shim adjustable for length of pull, cast and drop • 1/4" and 1/2" stock spacers for length of pull adjustment **FEATURES** Vector Pro lengthened forcing cone • Three Invector-DS choke tubes • Inflex recoil pad • Fiber-optic front sight • Ivory mid-bead sight • Includes ABS case **IDEAL USAGE** Hunting/Sporting Clays

C A5 STALKER **D A5, MOSSY OAK SHADOW GRASS BLADES** **E A5, MOSSY OAK BREAK-UP COUNTRY**

RECEIVER Strong, lightweight aluminum alloy **BARREL** Lightweight profile • Flat, ventilated rib **ACTION** 3" and 3-1/2" chamber models • Recoil-operated Kinematic Drive **STOCK** Composite with close radius pistol grip • Textured gripping surfaces • Shim adjustable for length of pull, cast and drop • Matte black or Mossy Oak® camo finishes • Dura-Touch Armor Coating • 1/4" and 1/2" stock spacers for length of pull adjustment **FEATURES** Vector Pro lengthened forcing cone • Three Invector-DS choke tubes • Inflex recoil pad • Fiber-optic front sight • Ivory mid-bead sight • Includes ABS case **IDEAL USAGE** Hunting/Sporting Clays/Turkey

	NEW 2015 GAUGE	CODE NUMBER	SUGGESTED RETAIL	BARREL LENGTH Inches	CHOKES Included	CHAMBER Inches	AVERAGE WEIGHT Lbs./Oz.	OVERALL LENGTH Inches	DROP AT COMB Inches	DROP AT HEEL Inches	LENGTH OF PULL Inches	RIB WIDTH Inches
A5 HUNTER												
	12	0118002003	1,759.99	30	F,M,I,C	3-1/2	6 / 15	51-5/8	1-3/4	2	14-1/4	1/4
	12	0118002004	1,759.99	28	F,M,I,C	3-1/2	6 / 13	49-5/8	1-3/4	2	14-1/4	1/4
B	12	0118002005	1,759.99	26	F,M,I,C	3-1/2	6 / 11	47-5/8	1-3/4	2	14-1/4	1/4
	12	0118003003	1,629.99	30	F,M,I,C	3	6 / 15	51-5/8	1-3/4	2	14-1/4	1/4
	12	0118003004	1,629.99	28	F,M,I,C	3	6 / 13	49-5/8	1-3/4	2	14-1/4	1/4
	12	0118003005	1,629.99	26	F,M,I,C	3	6 / 11	47-5/8	1-3/4	2	14-1/4	1/4
A5 STALKER												
	12	0118012003	1,629.99	30	F,M,I,C	3-1/2	7 / 7	51-5/8	1-3/4	2	14-1/4	1/4
	12	0118012004	1,629.99	28	F,M,I,C	3-1/2	7 / 5	49-5/8	1-3/4	2	14-1/4	1/4
C	12	0118012005	1,629.99	26	F,M,I,C	3-1/2	7 / 3	47-5/8	1-3/4	2	14-1/4	1/4
	12	0118013003	1,499.99	30	F,M,I,C	3	7 / 7	51-5/8	1-3/4	2	14-1/4	1/4
	12	0118013004	1,499.99	28	F,M,I,C	3	7 / 5	49-5/8	1-3/4	2	14-1/4	1/4
	12	0118013005	1,499.99	26	F,M,I,C	3	7 / 3	47-5/8	1-3/4	2	14-1/4	1/4
A5, MOSSY OAK SHADOW GRASS BLADES												
	12	0118182003	1,759.99	30	F,M,I,C	3-1/2	7 / 7	51-5/8	1-3/4	2	14-1/4	1/4
	12	0118182004	1,759.99	28	F,M,I,C	3-1/2	7 / 5	49-5/8	1-3/4	2	14-1/4	1/4
D	12	0118182005	1,759.99	26	F,M,I,C	3-1/2	7 / 3	47-5/8	1-3/4	2	14-1/4	1/4
	12	0118183003	1,629.99	30	F,M,I,C	3	7 / 7	51-5/8	1-3/4	2	14-1/4	1/4
	12	0118183004	1,629.99	28	F,M,I,C	3	7 / 5	49-5/8	1-3/4	2	14-1/4	1/4
	12	0118183005	1,629.99	26	F,M,I,C	3	7 / 3	47-5/8	1-3/4	2	14-1/4	1/4
A5, MOSSY OAK BREAK-UP COUNTRY												
	• 12	0118332003	1,759.99	30	F,M,I,C	3-1/2	7 / 7	51-5/8	1-3/4	2	14-1/4	1/4
E	• 12	0118332004	1,759.99	28	F,M,I,C	3-1/2	7 / 5	49-5/8	1-3/4	2	14-1/4	1/4
	• 12	0118332005	1,759.99	26	F,M,I,C	3-1/2	7 / 3	47-5/8	1-3/4	2	14-1/4	1/4
	• 12	0118333003	1,629.99	30	F,M,I,C	3	7 / 7	51-5/8	1-3/4	2	14-1/4	1/4
	• 12	0118333004	1,629.99	28	F,M,I,C	3	7 / 5	49-5/8	1-3/4	2	14-1/4	1/4
	• 12	0118333005	1,629.99	26	F,M,I,C	3	7 / 3	47-5/8	1-3/4	2	14-1/4	1/4

MAXUS SHOTGUNS.

Loaded with high performance features.

MAXUS®

POWER DRIVE
GAS SYSTEM



POWER DRIVE GAS SYSTEM

- Extensive research has produced the most reliable gas piston design ever.
- The gas piston features larger exhaust ports that dump gases faster with heavy loads to control recoil.
- 20% longer piston stroke travel increases reliability with light loads.
- An enclosed seal keeps residue out of the action for cleaner operation.

LESS MUZZLE JUMP

- The Power Drive Gas System works with the Inflex Technology recoil pad.
- Reduces muzzle jump up to 44% compared to the competition.

TURNKEY
MAGAZINE PLUG

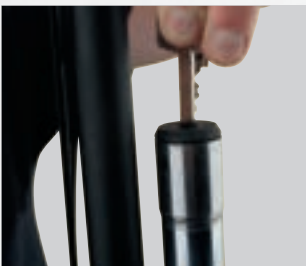

TURNKEY MAGAZINE PLUG

- The patented TurnKey Magazine Plug is easily removed in seconds using a standard car key.



MAGAZINE CUT-OFF

- The magazine cut-off (not available on Sporting models) allows the chamber to be unloaded to change loads without cycling a shell from the magazine.
- Useful when hunting different bird species and different loads are instantly required.

SPEED LOCK
FOREARM



SPEED LOCK FOREARM

- The patented Speed Lock Forearm replaces the traditional screw-on magazine cap.
- Makes taking down the Maxus for cleaning or storage fast.
- Makes attaching or removing the sling a snap.

SPEED LOAD
PLUS

SPEED LOAD PLUS

- Patented feeding system sends the first shell loaded into the magazine directly into the chamber.
- Speed Unload feature makes emptying the magazine fast and easy, without chambering and ejecting every shell with the bolt handle.

OPTIMAL DIMENSIONS

- The Maxus features a trim forearm and close radius pistol grip to maximize control.
- An externally relieved steel magazine tube reduces weight for a faster swing while retaining durability.
- Drop and cast can be tuned using the included stock shim kit.
- A low rib is in line with the top of the receiver and translates into dead-flat point of impact.

LIGHTNING
TRIGGER



LIGHTNING TRIGGER

- The Lightning Trigger is the finest fire control system ever offered in an autoloading shotgun.
- Offers a smooth, crisp feel with minimal travel.
- Lock times average .0052 seconds, 24% faster than the nearest competing autoloader.
- Easy to remove for cleaning.

THE SOFTEST SHOOTING
AUTOLOADER EVER

- Felt recoil is more than an instantaneous peak force; it is the total energy absorbing experience felt when a shell is fired.
- The Power Drive Gas System, Inflex Technology recoil pad, back-boring and natural Browning balance combine to transfer up to 18% less total felt recoil force to the shoulder than other autoloaders on the market.

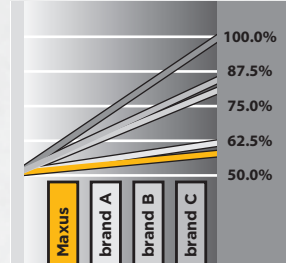

MUZZLE JUMP COMPARISON

LESS MUZZLE JUMP

- The Power Drive Gas System works with the Inflex Technology recoil pad.
- Reduces muzzle jump up to 44% compared to the competition.

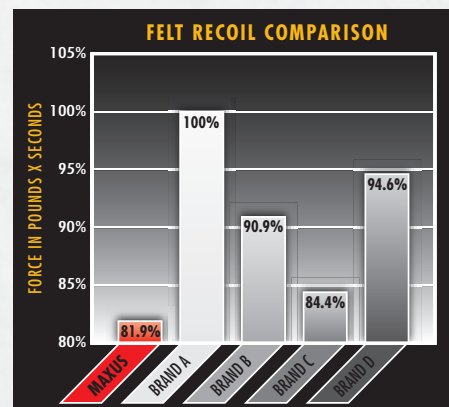
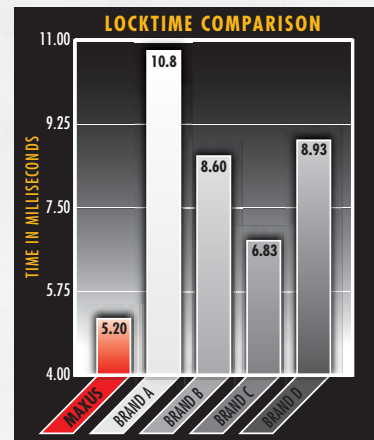

ALL BROWNING FIREARMS ARE SHIPPED WITH A FREE LOCKING DEVICE TO ASSIST IN THE SAFE STORAGE OF FIREARMS.

MAXIMUM SPEED AND RELIABILITY.

Maximum performance, maximum reliability and maximum cycling speed are what the Browning Maxus delivers. This premium gas-operated autoloader is feature packed and will exceed expectations every time it comes to the shoulder.



A MAXUS ULTIMATE

Ultimate Engraving, Left



B MAXUS HUNTER

Hunter Engraving, Right

Hunter Engraving, Left

A MAXUS ULTIMATE

RECEIVER Strong, lightweight aluminum alloy • Durable satin nickel finish • Laser engraving (pheasants on the right, mallards on the left) **BARREL** Lightweight profile • Flat, ventilated rib **ACTION** Gas-operated autoloader • 3" chamber • Power Drive Gas System reduces recoil and cycles a wide range of loads • Polished, engine-turned bolt finish **STOCK** Gloss oil finish Grade III walnut with close radius pistol grip • Sharp 22 lines-per-inch checkering • Speed Lock Forearm • Shim adjustable for length of pull, cast and drop • Two 1/4" stock spacers for length of pull adjustment **FEATURES** Vector Pro lengthened forcing cone • Three Invector-Plus choke tubes • Inflex recoil pad • Magazine Cut-Off • Brass front bead sight • Includes ABS case **IDEAL USAGE** Hunting/Sporting Clays

B MAXUS HUNTER

RECEIVER Strong, lightweight aluminum alloy • Durable satin nickel finish • Laser engraving (pheasant on the right, mallard on the left) **BARREL** Lightweight profile • Flat, ventilated rib **ACTION** Gas-operated autoloader • 3" and 3-1/2" chambered models • Power Drive Gas System reduces recoil and cycles a wide range of loads **STOCK** Gloss finish Grade I walnut with close radius pistol grip • Sharp 22 lines-per-inch checkering • Speed Lock Forearm • Shim adjustable for length of pull, cast and drop • One 1/4" stock spacer for length of pull adjustment **FEATURES** Vector Pro lengthened forcing cone • Three Invector-Plus choke tubes • Inflex recoil pad • Magazine Cut-Off • Brass front bead sight • Ivory mid-bead sight **IDEAL USAGE** Hunting/Sporting Clays

	NEW 2015 GAUGE	CODE NUMBER	SUGGESTED RETAIL	BARREL LENGTH Inches	CHOKES Included	CHAMBER Inches	AVERAGE WEIGHT lbs./Oz.	OVERALL LENGTH Inches	DROP AT COMB Inches	DROP AT HEEL Inches	LENGTH OF PULL Inches	RIB WIDTH Inches
MAXUS ULTIMATE												
A	12	011640303	1,939.99	30	F,M,I,C	3	7 / 4	51	1-3/4	2	14-1/4	1/4
	12	011640304	1,939.99	28	F,M,I,C	3	7 / 3	49	1-3/4	2	14-1/4	1/4
	12	011640305	1,939.99	26	F,M,I,C	3	7 / 1	47	1-3/4	2	14-1/4	1/4
MAXUS HUNTER												
B	12	011608203	1,699.99	30	F,M,I,C	3-1/2	7 / 4	51	1-3/4	2	14-1/4	1/4
	12	011608204	1,699.99	28	F,M,I,C	3-1/2	7 / 3	49	1-3/4	2	14-1/4	1/4
	12	011608205	1,699.99	26	F,M,I,C	3-1/2	7 / 1	47	1-3/4	2	14-1/4	1/4
	12	011608303	1,549.99	30	F,M,I,C	3	7 / 4	51	1-3/4	2	14-1/4	1/4
	12	011608304	1,549.99	28	F,M,I,C	3	7 / 3	49	1-3/4	2	14-1/4	1/4
	12	011608305	1,549.99	26	F,M,I,C	3	7 / 1	47	1-3/4	2	14-1/4	1/4



A MAXUS STALKER

B MAXUS, MOSSY OAK® SHADOW GRASS BLADES

NEW CAMO

C MAXUS ALL-PURPOSE HUNTER, MOSSY OAK® BREAK-UP COUNTRY®

NEW CAMO

D MAXUS RIFLED DEER, MOSSY OAK® BREAK-UP COUNTRY®

E MAXUS RIFLED DEER STALKER

- A MAXUS STALKER B MAXUS, MOSSY OAK SHADOW GRASS BLADES
- C MAXUS ALL-PURPOSE HUNTER, MOSSY OAK BREAK-UP COUNTRY

RECEIVER Strong, lightweight aluminum alloy **BARREL** Lightweight profile • Flat, ventilated rib **ACTION** Gas-operated autoloader • 3" and 3-1/2" chambered models • Power Drive Gas System reduces recoil and cycles a wide range of loads **STOCK** Composite with close radius pistol grip • Speed Lock Forearm • Textured gripping surfaces • Shim adjustable for length of pull, cast and drop • One 1/4" stock spacer for length of pull adjustment • Matte black or Mossy Oak® camo finishes • Dura-Touch Armor Coating **FEATURES** Vector Pro lengthened forcing cone • Three Invector-Plus choke tubes (All-Purpose Hunter also includes X-Tra Full Turkey tube) • Inflex recoil pad • Magazine Cut-Off • Fiber-optic front sight • Ivory mid-bead sight • All-Purpose Hunter includes a HiViz® magnetic combo sight set for turkey hunting and a brass bead front sight **IDEAL USAGE** Hunting/Sporting Clays/Turkey

- D MAXUS RIFLED DEER, MOSSY OAK BREAK-UP COUNTRY E MAXUS RIFLED DEER STALKER

RECEIVER Strong, lightweight aluminum alloy **BARREL** Thick-walled, fully rifled for slug ammunition **ACTION** Gas-operated autoloader • 3" chamber • Power Drive Gas System reduces recoil and cycles a wide range of loads **STOCK** Composite with close radius pistol grip • Speed Lock Forearm • Textured gripping surfaces • Shim adjustable for length of pull, cast and drop • One 1/4" stock spacer for length of pull adjustment • Matte black or Mossy Oak® camo finish • Dura-Touch Armor Coating **FEATURES** Cantilever scope mount • Inflex recoil pad **IDEAL USAGE** Deer Hunting

	NEW 2015 GAUGE	CODE NUMBER	SUGGESTED RETAIL	BARREL LENGTH Inches	CHOKES Included	CHAMBER Inches	AVERAGE WEIGHT Lbs./ Oz.	OVERALL LENGTH Inches	DROP AT COMB Inches	DROP AT HEEL Inches	LENGTH OF PULL Inches	RIB WIDTH Inches
MAXUS STALKER												
A	12	011600204	1,549.99	28	F,M,IC	3-1/2	7 / 2	49-1/4	1-3/4	2	14-1/4	1/4
	12	011600205	1,549.99	26	F,M,IC	3-1/2	7 / 0	47-1/4	1-3/4	2	14-1/4	1/4
	12	011600304	1,379.99	28	F,M,IC	3	7 / 2	49-1/4	1-3/4	2	14-1/4	1/4
	12	011600305	1,379.99	26	F,M,IC	3	7 / 0	47-1/4	1-3/4	2	14-1/4	1/4
MAXUS, MOSSY OAK SHADOW GRASS BLADES												
B	12	011645204	1,659.99	28	F,M,IC	3-1/2	7 / 2	49-1/4	1-3/4	2	14-1/4	1/4
	12	011645205	1,659.99	26	F,M,IC	3-1/2	7 / 0	47-1/4	1-3/4	2	14-1/4	1/4
	12	011645304	1,519.99	28	F,M,IC	3	7 / 3	49-1/4	1-3/4	2	14-1/4	1/4
	12	011645305	1,519.99	26	F,M,IC	3	7 / 0	47-1/4	1-3/4	2	14-1/4	1/4
MAXUS ALL PURPOSE HUNTER, MOSSY OAK BREAK-UP COUNTRY												
C	• 12	011659205	1,739.99	26	XF,F,M,IC	3-1/2	7 / 1	47-1/4	1-3/4	2	14-1/4	1/4
MAXUS RIFLED DEER, MOSSY OAK BREAK-UP COUNTRY												
D	• 12	011660321	1,639.99	22	Rif. Bbl./Cant.	3	7 / 3	43-1/4	1-3/4	2	14-1/4	28
MAXUS RIFLED DEER STALKER												
E	12	011620321	1,519.99	22	Rif. Bbl./Cant.	3	7 / 3	43-1/4	1-3/4	2	14-1/4	28





F MAXUS SPORTING GOLDEN CLAYS



Golden Clays Engraving, Top



Golden Clays Engraving, Right



Golden Clays Engraving, Left



G MAXUS SPORTING

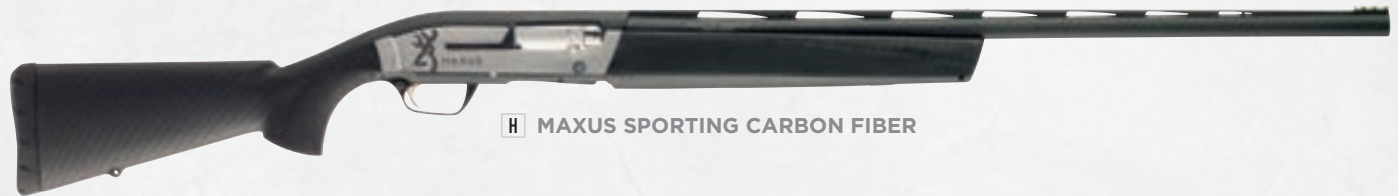

H MAXUS SPORTING CARBON FIBER

F MAXUS SPORTING GOLDEN CLAYS

RECEIVER Strong, lightweight aluminum alloy • Durable satin nickel finish • Gold enhanced engravings of game birds transforming into a clay target (quail on the right, mallard on the left)
BARREL Lightweight profile • Flat, ventilated rib **ACTION** Gas-operated autoloader • 3" chamber • Power Drive Gas System reduces recoil and cycles a wide range of loads • Polished, engine-turned bolt finish **STOCK** Gloss finish Grade III walnut with close radius pistol grip • Sharp 22 lines-per-inch checkering • Speed Lock Forearm • Shim adjustable for length of pull, cast and drop • Two 1/4" stock spacers for length of pull adjustment **FEATURES** Vector Pro lengthened forcing cone • Five Invector-Plus choke tubes • Inflex recoil pad • HiViz® TriComp fiber-optic front sight • Ivory mid-bead sight • Includes ABS case **IDEAL USAGE** Hunting/Sporting Clays

G MAXUS SPORTING

RECEIVER Strong, lightweight aluminum alloy • Durable satin nickel finish • Full coverage, high-relief engraving features game birds transforming into a clay target (quail on the right, mallard on the left) **BARREL** Lightweight profile • Flat, ventilated rib **ACTION** Gas-operated autoloader • 3" chamber • Power Drive Gas System reduces recoil and cycles a wide range of loads
STOCK Gloss varnish finish High Grade walnut with close radius pistol grip • Sharp 22 lines-per-inch checkering • Speed Lock Forearm • Shim adjustable for length of pull, cast and drop • Two 1/4" stock spacers for length of pull adjustment **FEATURES** Vector Pro lengthened forcing cone • Five Invector-Plus choke tubes • Inflex recoil pad • HiViz® TriComp fiber-optic front sight • Ivory mid-bead sight • Includes ABS case **IDEAL USAGE** Hunting/Sporting Clays

H MAXUS SPORTING CARBON FIBER

RECEIVER Strong, lightweight aluminum alloy • Carbon fiber finish on top and bottom **BARREL** Lightweight profile • Flat, ventilated rib • Carbon fiber finish **ACTION** Gas-operated autoloader • 3" chamber • Power Drive Gas System reduces recoil and cycles a wide range of loads **STOCK** Composite with close radius pistol grip • Speed Lock Forearm • Textured gripping surfaces • Shim adjustable for length of pull, cast and drop • Carbon fiber finish • Dura-Touch Armor Coating • Two 1/4" stock spacers for length of pull adjustment **FEATURES** Vector Pro lengthened forcing cone • Five Invector-Plus choke tubes • Inflex recoil pad • HiViz® TriComp fiber-optic front sight • Ivory mid-bead sight • Includes ABS case **IDEAL USAGE** Hunting/Sporting Clays

NEW 2015	GAUGE	CODE NUMBER	SUGGESTED RETAIL	BARREL LENGTH Inches	CHOKES Included	CHAMBER Inches	AVERAGE WEIGHT Lbs./Oz.	OVERALL LENGTH Inches	DROP AT COMB Inches	DROP AT HEEL Inches	LENGTH OF PULL Inches	RIB WIDTH Inches
MAXUS SPORTING GOLDEN CLAYS												
F	12	011635303	2,069.99	30	F,IM,M,IC,SK	3	7 / 4	51	1-3/4	2	14-1/4	1/4-5/16
	12	011635304	2,069.99	28	F,IM,M,IC,SK	3	7 / 3	49	1-3/4	2	14-1/4	1/4-5/16
MAXUS SPORTING												
	12	011616303	1,759.99	30	F,IM,M,IC,SK	3	7 / 4	51	1-3/4	2	14-1/4	1/4-5/16
G	12	011616304	1,759.99	28	F,IM,M,IC,SK	3	7 / 3	49	1-3/4	2	14-1/4	1/4-5/16
MAXUS SPORTING CARBON FIBER												
	12	011609303	1,549.99	30	F,IM,M,IC,SK	3	7 / 3	51	1-3/4	2	14-1/4	1/4-5/16
H	12	011609304	1,549.99	28	F,IM,M,IC,SK	3	7 / 2	49	1-3/4	2	14-1/4	1/4-5/16

PURE BROWNING PERFORMANCE.

Adding extra features to a shotgun also adds cost. The truth is, some people simply want a high-quality, long-lasting autoloader that gets the job done every time they pull the trigger. The Browning Silver fills that role with genuine Browning style.



LESS RECOIL WITH THE ACTIVE VALVE

- The self-adjusting Active Valve gas system in Silver autoloaders diverts gases from fired shells to operate the action instead of adding to recoil.
- When shooting light loads, most of the gases operate the action.
- With magnum loads, only a small amount of gas is necessary to operate the action, while the remaining gases are vented out the top of the forearm and away from the receiver for cleaner, more reliable operation.
- Superior recoil reduction from the Active Valve means faster, more accurate follow-up shots and all-day shooting comfort regardless of the loads being fired.



MAXIMUM GRIP

- Composite Silver models combine checkered gripping surfaces and proven Dura-Touch Armor Coating for a sure hold and a sleek feel in all climate conditions.



TRIGGER

- The trigger assembly can be removed in just seconds for a thorough cleaning.
- The trigger guard is large and has carefully rounded edges to accommodate gloved fingers.

LOAD VERSATILITY

- The Active Valve-equipped gas piston efficiently adjusts to reliably fire a wide range of loads.
- 12 gauge 3" models fire everything from light, 1 oz., 2-3/4" field loads to the heaviest 3" magnums. The 3-1/2" version is built to handle a similar range, from 1-1/8 oz., 2-3/4" field loads up to hard-hitting 3-1/2" magnum loads.



Light Load (1 oz.)



Heavy Load (2 oz.)

ALL BROWNING FIREARMS ARE SHIPPED WITH A FREE LOCKING DEVICE TO ASSIST IN THE SAFE STORAGE OF FIREARMS.



A SILVER LIGHTNING, FULL LINE DEALER



RECEIVER Strong, lightweight aluminum alloy • Semi-humpback design • Silver finish **BARREL** Lightweight profile • Ventilated rib **ACTION** Gas-operated autoloader • 3" chamber • Active Valve System reliably cycles a wide range of loads **STOCK** Lightning-style, gloss finish walnut **FEATURES** Three Invector-Plus choke tubes • Brass front bead sight • Available only from Browning Full Line and Medallion Dealers **IDEAL USAGE** Hunting/Sporting Clays

NEW 2015 GAUGE	CODE NUMBER	SUGGESTED RETAIL	BARREL LENGTH Inches	CHOKES Included	CHAMBER Inches	AVERAGE WEIGHT lbs. / oz.	OVERALL LENGTH Inches	DROP AT COMB Inches	DROP AT HEEL Inches	LENGTH OF PULL Inches	RIB WIDTH Inches
SILVER LIGHTNING, FULL LINE DEALER											
A 12	011368304	1,199.99	28	F,M,IC	3	7 / 6	49	1-3/4	2	14-1/4	1/4
12	011368305	1,199.99	26	F,M,IC	3	7 / 4	47	1-3/4	2	14-1/4	1/4





B SILVER HUNTER MICRO MIDAS



C SILVER HUNTER



D SILVER SPORTING MICRO

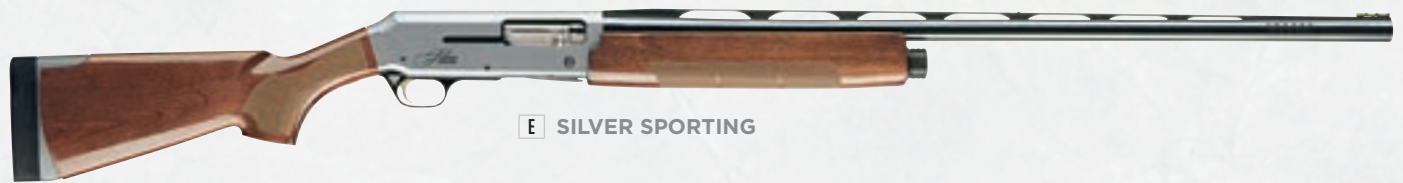

E SILVER SPORTING

B SILVER HUNTER MICRO MIDAS **C SILVER HUNTER**

RECEIVER Strong, lightweight aluminum alloy • Semi-humpback design • Silver finish **BARREL** Lightweight profile • Ventilated rib **ACTION** Gas-operated autoloader • 3" and 3-1/2" chamber models • Active Valve System reliably cycles a wide range of loads **STOCK** Satin finish walnut • Inflex recoil pad • Micro Midas comes with one 1/4" stock spacer **FEATURES** Three Invector-Plus choke tubes • Brass front bead sight **IDEAL USAGE** Hunting/Sporting Clays **MICRO MIDAS IS ELIGIBLE FOR THE GROWTH INSURANCE PROGRAM** See page 2 for details.

D SILVER SPORTING MICRO **E SILVER SPORTING**

RECEIVER Strong, lightweight aluminum alloy • Semi-humpback design • Silver finish **BARREL** Lightweight profile • Ventilated rib • Ported **ACTION** Gas-operated autoloader • 2-3/4" chamber • Active Valve System reliably cycles a wide range of loads **STOCK** Gloss finish walnut stock and forearm • 3/4" length of pull adjustment in 1/4" increments using the three included adjustment spacers • Premium Pachmayr® Decelerator® recoil pad **FEATURES** Three Invector-Plus choke tubes • Sporting has a HiViz® TriComp fiber-optic sight and mid-bead • Sporting Micro has a brass bead sight and mid-bead • Two Active Valve pistons included to optimize performance with light or heavy loads **IDEAL USAGE** Skeet/Sporting Clays **MICRO IS ELIGIBLE FOR THE GROWTH INSURANCE PROGRAM** See page 2 for details.

NEW 2015	GAUGE	CODE NUMBER	SUGGESTED RETAIL	BARREL LENGTH Inches	CHOICES Included	CHAMBER Inches	AVERAGE WEIGHT lbs./oz.	OVERALL LENGTH Inches	DROP AT COMB Inches	DROP AT HEEL Inches	LENGTH OF PULL Inches	RIB WIDTH Inches
SILVER HUNTER MICRO MIDAS												
B	12	011389305	1,199.99	26	F,M,IC	3	7 / 5	45-3/4	1-1/2	1-3/4	13	1/4
	12	011389306	1,199.99	24	F,M,IC	3	7 / 3	43-3/4	1-1/2	1-3/4	13	1/4
	20	011389605	1,199.99	26	F,M,IC	3	6 / 2	45-3/4	1-1/2	1-3/4	13	1/4
	20	011389606	1,199.99	24	F,M,IC	3	6 / 0	43-3/4	1-1/2	1-3/4	13	1/4
SILVER HUNTER												
C	12	011350204	1,359.99	28	F,M,IC	3-1/2	7 / 9	49	1-3/4	2	14-1/4	1/4
	12	011350205	1,359.99	26	F,M,IC	3-1/2	7 / 8	47	1-3/4	2	14-1/4	1/4
	12	011350303	1,199.99	30	F,M,IC	3	7 / 6	51	1-3/4	2	14-1/4	1/4
	12	011350304	1,199.99	28	F,M,IC	3	7 / 5	49	1-3/4	2	14-1/4	1/4
	12	011350305	1,199.99	26	F,M,IC	3	7 / 4	47	1-3/4	2	14-1/4	1/4
	20	011350604	1,199.99	28	F,M,IC	3	6 / 7	48-3/4	1-3/4	2-1/4	14-1/4	1/4
	20	011350605	1,199.99	26	F,M,IC	3	6 / 5	46-3/4	1-3/4	2-1/4	14-1/4	1/4
SILVER SPORTING MICRO												
D	12	011373428	1,319.99	28	F,M,IC	2-3/4	7 / 5	48	1-1/2	1-3/4	13-3/8	1/4
SILVER SPORTING												
E	12	011377427	1,319.99	30	F,M,IC	2-3/4	7 / 9	50-3/4	1-1/2	1-3/4	14-1/4 adj.	1/4
	12	011377428	1,319.99	28	F,M,IC	2-3/4	7 / 8	48-3/4	1-1/2	1-3/4	14-1/4 adj.	1/4





A SILVER STALKER



B SILVER, MOSSY OAK® SHADOW GRASS BLADES

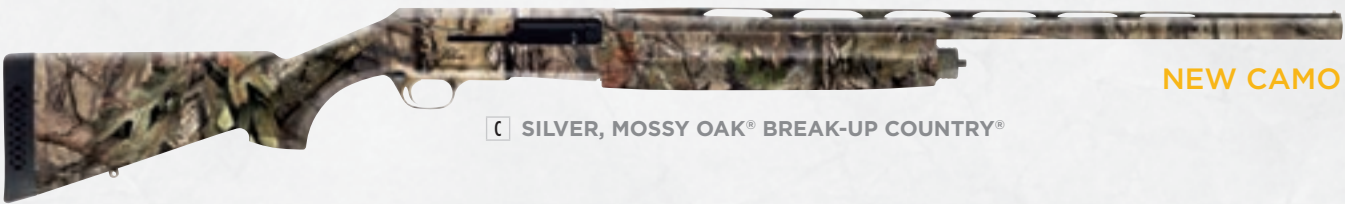

C SILVER, MOSSY OAK® BREAK-UP COUNTRY®

NEW CAMO



D SILVER NWTF®, MOSSY OAK® BREAK-UP COUNTRY®

NEW CAMO

A SILVER STALKER

RECEIVER Aluminum alloy • Semi-humpback design **BARREL** Lightweight profile • Ventilated rib **ACTION** Gas-operated autoloader • 3-1/2" chamber • Active Valve System reliably cycles a wide range of loads **STOCK** Composite • Matte black finish • Dura-Touch Armor Coating **FEATURES** Three Invector-Plus choke tubes • Brass front bead sight **IDEAL USAGE** Hunting/Sporting Clays

B SILVER, MOSSY OAK SHADOW GRASS BLADES **C SILVER, MOSSY OAK BREAK-UP COUNTRY**

RECEIVER Aluminum alloy • Semi-humpback design **BARREL** Lightweight profile • Ventilated rib **ACTION** Gas-operated autoloader • 3-1/2" chamber • Active Valve System reliably cycles a wide range of loads **STOCK** Composite • Dura-Touch Armor Coating • Mossy Oak® camo finishes **FEATURES** Three Invector-Plus choke tubes • Brass front bead sight **IDEAL USAGE** Hunting

D SILVER NWTF, MOSSY OAK BREAK-UP COUNTRY

RECEIVER Aluminum alloy • Semi-humpback design • Drilled and tapped for scope mounts **BARREL** Lightweight profile • Ventilated rib **ACTION** Gas-operated autoloader • 3-1/2" chamber • Active Valve System reliably cycles a wide range of loads **STOCK** Composite • Dura-Touch Armor Coating • Mossy Oak® Break-Up Country® camo finish **FEATURES** Three Invector-Plus choke tubes including a Full Strut Turkey tube • HiViz® 4-in-1 fiber-optic sight **IDEAL USAGE** Turkey Hunting

NEW 2015	GAUGE	CODE NUMBER	SUGGESTED RETAIL	BARREL LENGTH Inches	CHOKES Included	CHAMBER Inches	AVERAGE WEIGHT Lbs./ Oz.	OVERALL LENGTH Inches	DROP AT COMB Inches	DROP AT HEEL Inches	LENGTH OF PULL Inches	RIB WIDTH Inches
SILVER STALKER												
A	12	011351204	1,229.99	28	F,M,IC	3-1/2	7 / 9	49	1-3/4	2	14-1/4	1/4
	12	011351205	1,229.99	26	F,M,IC	3-1/2	7 / 8	47	1-3/4	2	14-1/4	1/4
SILVER, MOSSY OAK SHADOW GRASS BLADES												
B	12	011403204	1,359.99	28	F,M,IC	3-1/2	7 / 9	49	1-3/4	2	14-1/4	1/4
	12	011403205	1,359.99	26	F,M,IC	3-1/2	7 / 8	47	1-3/4	2	14-1/4	1/4
SILVER, MOSSY OAK BREAK-UP COUNTRY												
C	• 12	011409205	1,359.99	26	F,M,IC	3-1/2	7 / 8	47	1-3/4	2	14-1/4	1/4
SILVER NWTF, MOSSY OAK BREAK-UP COUNTRY												
D	• 12	011410206	1,579.99	24	Full Str Trky,M,IC	3-1/2	7 / 4	45	1-3/4	2	14-1/4	1/4



VALUE AND VERSATILITY.

Hunting deer, bear or wild boar with a shotgun is increasing in popularity, and improvements in ammunition make modern slug guns — like the Browning Silver — very effective at bringing down heavy game. There is also a side benefit to hunting with a Browning, accessory barrels are available that easily convert the same shotgun into a wingshooter. The cantilever scope mount makes swapping barrels easy without affecting the scope's zero.



E SILVER RIFLED DEER STALKER



NEW CAMO

F SILVER RIFLED DEER, MOSSY OAK® BREAK-UP COUNTRY®



G SILVER RIFLED DEER SATIN

E SILVER RIFLED DEER STALKER F SILVER RIFLED DEER, MOSSY OAK BREAK-UP COUNTRY

RECEIVER Aluminum alloy • Semi-humpback design **BARREL** Thick-walled, fully rifled for slug ammunition **ACTION** Gas-operated autoloader • 3" chamber • Active Valve System reliably cycles a wide range of loads **STOCK** Composite • Dura-Touch Armor Coating • Matte black or Mossy Oak® Break-Up Country® camo finish **FEATURES** Cantilever scope mount **IDEAL USAGE** Deer Hunting

G SILVER RIFLED DEER SATIN

RECEIVER Aluminum alloy • Semi-humpback design **BARREL** Thick-walled fully rifled for slug ammunition **ACTION** Gas-operated autoloader • 3" chamber • Active Valve System reliably cycles a wide range of loads **STOCK** Satin finish walnut **FEATURES** Cantilever scope mount (Scope and rings not included) **IDEAL USAGE** Deer Hunting

NEW 2015	GAUGE	CODE NUMBER	SUGGESTED RETAIL	BARREL LENGTH Inches	CHOKES Included	CHAMBER Inches	AVERAGE WEIGHT Lbs./Oz.	OVERALL LENGTH Inches	DROP AT COMB Inches	DROP AT HEEL Inches	LENGTH OF PULL Inches	RATE OF TWIST Inches
SILVER RIFLED DEER STALKER												
E	12	011351321	1,309.99	22	Rif. Bbl./Cant.	3	7 / 12	43	1-3/4	2	14-1/4	28
SILVER RIFLED DEER, MOSSY OAK BREAK-UP COUNTRY												
F	• 12	011411321	1,459.99	22	Rif. Bbl./Cant.	3	7 / 12	43	1-3/4	2	14-1/4	28
	• 20	011411621	1,459.99	22	Rif. Bbl./Cant.	3	6 / 12	42-3/4	1-3/4	2-1/4	14-1/4	24
SILVER RIFLED DEER SATIN												
G	20	011371621	1,359.99	22	Rif. Bbl./Cant.	3	6 / 12	42-3/4	1-3/4	2-1/4	14-1/4	24



THE BEST PUMP THERE IS.

For most companies, the pump shotgun is an entry-level item built for the beginner. We don't see it that way, knowing there are shooters who demand the highest quality and reliability from their pump shotgun. The BPS uses a rugged, steel frame and twin action bars for long-lasting, bind-free, pump-action performance.

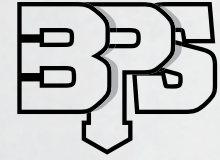

BOTTOM EJECTION AND LOADING

- Unique bottom ejection throws empty hulls straight down, out of the line of sight.
- The BPS is the best pump shotgun choice for both right- and left-handed shooters.

MAGAZINE CAPACITY

- 2-3/4": Four in magazine, one in chamber.
- 3": Three in magazine, one in chamber.
- 3-1/2": Three in magazine, one in chamber.
- A three-shot magazine adaptor plug is included.



RELIABLE PUMP-ACTION

- The proven pump-action features rugged steel components.
- The receiver is machined from a solid block of forged steel.
- Rigid double slide bars are made from heat-treated steel to eliminate twisting and binding for faster, more efficient slide-action operation.
- Reliable in all conditions.
- A convenient serrated slide release is located at the rear of the trigger guard.



MAXIMUM GRIP

- Camo composite BPS models combine in-molded checkered gripping surfaces and our proven Dura-Touch Armor Coating for a sure hold and a sleek feel in all climate conditions.



TANG SAFETY

- The thumb-operated, top-tang safety on the BPS can easily be operated with the right or left hand, even with gloves on.

ALL BROWNING FIREARMS ARE SHIPPED WITH A FREE LOCKING DEVICE TO ASSIST IN THE SAFE STORAGE OF FIREARMS.



A BPS HUNTER

RECEIVER Forged and machined steel • High polish blued finish **BARREL** Ventilated rib **ACTION** Bottom ejection • Dual steel action bars • Top-tang safety **STOCK** Satin finish walnut **FEATURES** Three Invector-Plus choke tubes with 12 and 20 • Three Standard Invector choke tubes with 16, 28 and .410 • Recoil pad on 12 gauge model • Silver colored front bead sight **IDEAL USAGE** Hunting/Sporting Clays

	NEW 2015 GAUGE / BORE	CODE NUMBER	SUGGESTED RETAIL	BARREL LENGTH inches	CHOKES Included	CHAMBER inches	AVERAGE WEIGHT lbs. / Oz.	OVERALL LENGTH inches	DROP AT COMB inches	DROP AT HEEL inches	LENGTH OF PULL inches	RIB WIDTH inches
BPS HUNTER												
A	12	012211304	699.99	28	F,M,I,C	3	7 / 11	48-3/4	1-5/8	1-7/8	14-1/4	5/16
	12	012211305	699.99	26	F,M,I,C	3	7 / 10	46-3/4	1-5/8	1-7/8	14-1/4	5/16
	16	012211513	729.99	28	F,M,I,C	2-3/4	7 / 2	48-3/4	1-5/8	1-7/8	14-1/4	5/16
	16	012211514	729.99	26	F,M,I,C	2-3/4	7 / 1	46-3/4	1-5/8	1-7/8	14-1/4	5/16
	20	012211604	699.99	28	F,M,I,C	3	7 / 1	48-3/4	1-5/8	1-7/8	14-1/4	5/16
	20	012211605	699.99	26	F,M,I,C	3	7 / 0	46-3/4	1-5/8	1-7/8	14-1/4	5/16
	28	012211813	729.99	28	F,M,I,C	2-3/4	7 / 0	48-3/4	1-5/8	1-7/8	14-1/4	5/16
	28	012211814	729.99	26	F,M,I,C	2-3/4	6 / 15	46-3/4	1-5/8	1-7/8	14-1/4	5/16
	.410	012211914	729.99	26	F,M,I,C	3	7 / 0	46-3/4	1-5/8	1-7/8	14-1/4	5/16
	.410	012270915	729.99	24	F,M,I,C	3	6 / 15	43-3/4	1-5/8	1-7/8	14-1/4	5/16



B BPS MICRO MIDAS



C BPS UPLAND SPECIAL



D BPS TRAP



E BPS MICRO TRAP

B BPS MICRO MIDAS

RECEIVER Forged and machined steel • High polish blued finish **BARREL** Ventilated rib **ACTION** Bottom ejection • Dual steel action bars • Top-tang safety **STOCK** Satin finish walnut • Compact 13" length of pull • Scaled down to comfortably fit smaller shooters **FEATURES** Three Invector-Plus choke tubes with 12 and 20 • Three Standard Invector choke tubes with .410 • Inflex recoil pad • Two 1/4" stock spacers • Silver colored front bead sight **IDEAL USAGE** Hunting/Sporting Clays **ELIGIBLE FOR THE GROWTH INSURANCE PROGRAM** See page 2 for details.

C BPS UPLAND SPECIAL

RECEIVER Forged and machined steel • High polish blued finish **BARREL** Ventilated rib **ACTION** Bottom ejection • Dual steel action bars • Top-tang safety **STOCK** Satin finish walnut • English-style straight grip **FEATURES** Three Invector-Plus choke tubes with 12 and 20 • Three Standard Invector with 16 • Silver colored front bead sight **IDEAL USAGE** Hunting/Sporting Clays

D BPS TRAP **E BPS MICRO TRAP**

RECEIVER Engraved • Forged and machined steel • High polish blued finish **BARREL** Ventilated rib **ACTION** Bottom ejection • Dual steel action bars • Top-tang safety **STOCK** Satin finish walnut • Raised comb **FEATURES** Magazine cut-off • Three Invector-Plus choke tubes • HiViz® Pro-Comp fiber-optic sight • Mid-bead sight **IDEAL USAGE** Trap **MICRO TRAP IS ELIGIBLE FOR THE GROWTH INSURANCE PROGRAM** See page 2 for details.

	NEW 2015	GAUGE / BORE	CODE NUMBER	SUGGESTED RETAIL	BARREL LENGTH Inches	CHOKES Included	CHAMBER Inches	AVERAGE WEIGHT lbs. / Oz.	OVERALL LENGTH Inches	DROP AT COMB Inches	DROP AT HEEL Inches	LENGTH OF PULL Inches	RIB WIDTH Inches
BPS MICRO MIDAS													
		12	012270305	699.99	26	F,M,IC	3	7 / 10	45-3/4	1-5/8	1-5/8	13	5/16
B		12	012270306	699.99	24	F,M,IC	3	7 / 9	43-3/4	1-5/8	1-5/8	13	5/16
		12	012270307	699.99	22	F,M,IC	3	7 / 8	41-3/4	1-5/8	1-5/8	13	5/16
		20	012270605	699.99	26	F,M,IC	3	7 / 11	45-3/4	1-5/8	1-5/8	13	5/16
		20	012270606	699.99	24	F,M,IC	3	7 / 0	43-3/4	1-5/8	1-5/8	13	5/16
		20	012270607	699.99	22	F,M,IC	3	6 / 15	41-3/4	1-5/8	1-5/8	13	5/16
		.410	012270914	729.99	26	F,M,IC	3	7 / 0	45-3/4	1-5/8	1-5/8	13	5/16
		.410	012270915	729.99	24	F,M,IC	3	6 / 15	43-3/4	1-5/8	1-5/8	13	5/16
BPS UPLAND SPECIAL													
		12	012216307	699.99	22	F,M,IC	3	7 / 8	42-1/2	1-5/8	1-7/8	14	5/16
		16	012216514	729.99	26	F,M,IC	2-3/4	6 / 13	46-1/2	1-5/8	1-7/8	14	5/16
		16	012216515	729.99	24	F,M,IC	2-3/4	6 / 12	44-1/2	1-5/8	1-7/8	14	5/16
C		20	012216607	699.99	22	F,M,IC	3	6 / 11	42-1/2	1-5/8	1-7/8	14	5/16
BPS TRAP													
D		12	012242403	839.99	30	F,IM,M	2-3/4	8 / 6	51	1-3/8	2	14-3/8	5/16
BPS MICRO TRAP													
E		12	012241404	839.99	28	F,IM,M	2-3/4	8 / 1	48-1/4	1-3/8	2	13-3/4	5/16



A BPS STALKER



B BPS, MOSSY OAK® SHADOW GRASS BLADES



C BPS, MOSSY OAK® BREAK-UP COUNTRY®

NEW CAMO



D BPS NWTF®, MOSSY OAK® BREAK-UP COUNTRY®

NEW CAMO

A BPS STALKER B BPS, MOSSY OAK SHADOW GRASS BLADES C BPS, MOSSY OAK BREAK-UP COUNTRY

RECEIVER Forged and machined steel **BARREL** Ventilated rib **ACTION** Bottom ejection • Dual steel action bars • Top-tang safety **STOCK** Composite • Matte black or Mossy Oak® camo finishes
FEATURES Three Invector-Plus choke tubes • Silver colored front bead sight **IDEAL USAGE** Hunting/Sporting Clays

D BPS NWTF, MOSSY OAK BREAK-UP COUNTRY

RECEIVER Forged and machined steel • Drilled and tapped for scope mounts **BARREL** Ventilated rib **ACTION** Bottom ejection • Dual steel action bars • Top-tang safety **STOCK** Composite • Dura-Touch Armor Coating • Mossy Oak® Break-Up Country® camo finish **FEATURES** Three Invector-Plus choke tubes • HiViz® 4-in-1 fiber-optic sight • NWTF® buttstock decal **IDEAL USAGE** Hunting/Turkey Hunting

	NEW 2015 GAUGE	CODE NUMBER	SUGGESTED RETAIL	BARREL LENGTH Inches	CHOKES Included	CHAMBER Inches	AVERAGE WEIGHT Lbs. / Oz.	OVERALL LENGTH Inches	DROP AT COMB Inches	DROP AT HEEL Inches	LENGTH OF PULL Inches	RIB WIDTH Inches
BPS STALKER												
	12	012212204	799.99	28	F,M,I,C	3-1/2	8 / 5	49-1/4	1-1/2	2-1/2	14-1/4	5/16
	12	012212205	799.99	26	F,M,I,C	3-1/2	8 / 4	47-1/4	1-1/2	2-1/2	14-1/4	5/16
A	12	012212303	699.99	30	F,M,I,C	3	8 / 2	50-3/4	1-1/2	2-1/2	14-1/4	5/16
	12	012212304	699.99	28	F,M,I,C	3	8 / 1	48-3/4	1-1/2	2-1/2	14-1/4	5/16
	12	012212305	699.99	26	F,M,I,C	3	8 / 0	46-3/4	1-1/2	2-1/2	14-1/4	5/16
BPS, MOSSY OAK SHADOW GRASS BLADES												
	12	012271204	949.99	28	F,M,I,C	3-1/2	8 / 5	49-1/4	1-1/2	2-1/2	14-1/4	5/16
B	12	012271205	949.99	26	F,M,I,C	3-1/2	8 / 4	47-1/4	1-1/2	2-1/2	14-1/4	5/16
	12	012271304	819.99	28	F,M,I,C	3	8 / 1	48-3/4	1-1/2	2-1/2	14-1/4	5/16
	12	012271305	819.99	26	F,M,I,C	3	8 / 0	46-3/4	1-1/2	2-1/2	14-1/4	5/16
BPS, MOSSY OAK BREAK-UP COUNTRY												
C	• 12	012279204	949.99	28	F,M,I,C	3-1/2	8 / 5	49-1/4	1-1/2	2-1/2	14-1/4	5/16
	• 12	012279205	949.99	26	F,M,I,C	3-1/2	8 / 4	47-1/4	1-1/2	2-1/2	14-1/4	5/16
	• 12	012279304	819.99	28	F,M,I,C	3	8 / 1	48-3/4	1-1/2	2-1/2	14-1/4	5/16
	• 12	012279305	819.99	26	F,M,I,C	3	8 / 0	46-3/4	1-1/2	2-1/2	14-1/4	5/16
BPS NWTF, MOSSY OAK BREAK-UP COUNTRY												
D	• 12	012280206	1,029.99	24	XF Trky,M,I,C	3-1/2	8 / 3	45-1/4	1-1/2	2-1/2	14-1/4	5/16
	• 12	012280306	949.99	24	XF Trky,M,I,C	3	7 / 15	44-3/4	1-1/2	2-1/2	14-1/4	5/16



READY FOR ANY PURSUIT.

Why limit a shotgun as great as the BPS to just wingshooting? This versatile and incredibly durable pump-action platform lends itself well to every type of hunting and shooting sport.

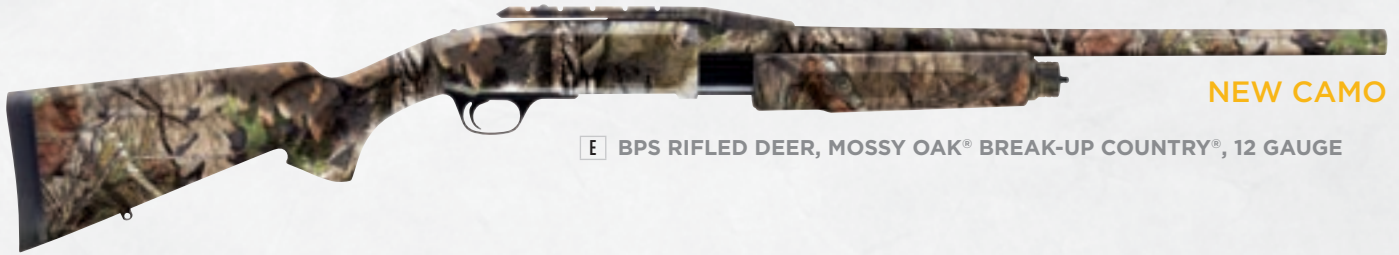

NEW CAMO

E BPS RIFLED DEER, MOSSY OAK® BREAK-UP COUNTRY®, 12 GAUGE



NEW CAMO

F BPS RIFLED DEER, MOSSY OAK® BREAK-UP COUNTRY®, 20 GAUGE



G BPS RIFLED DEER HUNTER

E BPS RIFLED DEER, MOSSY OAK BREAK-UP COUNTRY, 12 GA. F BPS RIFLED DEER, MOSSY OAK BREAK-UP COUNTRY, 20 GA.

RECEIVER Forged and machined steel **BARREL** Thick-walled for slug and sabot ammunition • Rifled 12 gauge: 1 in 28", 20 gauge: 1 in 35 twist **ACTION** Bottom ejection • Dual steel action bars • Top-tang safety **STOCK** 12 gauge: Composite • 20 gauge: Walnut • Dura-Touch Armor Coating • Mossy Oak® Break-Up Country® camo finish **FEATURES** Cantilever scope mount **IDEAL USAGE** Deer Hunting

G BPS RIFLED DEER HUNTER

RECEIVER Forged and machined steel **BARREL** Thick-walled for slug and sabot ammunition • Rifled, 12 gauge: 1 in 28" twist, 20 gauge: 1 in 35" twist **ACTION** Bottom ejection • Dual steel action bars • Top-tang safety **STOCK** Satin finish walnut **FEATURES** Cantilever scope mount **IDEAL USAGE** Deer Hunting

NEW 2015	GAUGE	CODE NUMBER	SUGGESTED RETAIL	BARREL LENGTH Inches	CHOKES Included	CHAMBER Inches	AVERAGE WEIGHT lbs. / Oz.	OVERALL LENGTH Inches	DROP AT COMB Inches	DROP AT HEEL Inches	LENGTH OF PULL Inches	RATE OF TWIST Inches
BPS RIFLED DEER, MOSSY OAK BREAK-UP COUNTRY, 12 GAUGE												
E	• 12	012281324	869.99	22	Rif. Bbl./Cant.	3	7 / 10	42-1/2	1-1/2	2-1/2	14-1/4	28
BPS RIFLED DEER, MOSSY OAK BREAK-UP COUNTRY, 20 GAUGE												
F	• 20	012281624	979.99	22	Rif. Bbl./Cant.	3	7 / 5	42-1/4	1-5/8	1-7/8	14	35
BPS RIFLED DEER HUNTER												
G	12	012214324	829.99	22	Rif. Bbl./Cant.	3	7 / 10	42-1/4	1-1/2	1-5/8	14	28
	20	012214624	839.99	22	Rif. Bbl./Cant.	3	7 / 4	42-1/4	1-5/8	1-5/8	14	35

BIG BORES.

The potent 10 gauge is always a force to be reckoned with. When the quarry is big, like geese and turkey, there is no substitute for a large bore size and a hefty shot payload to match.

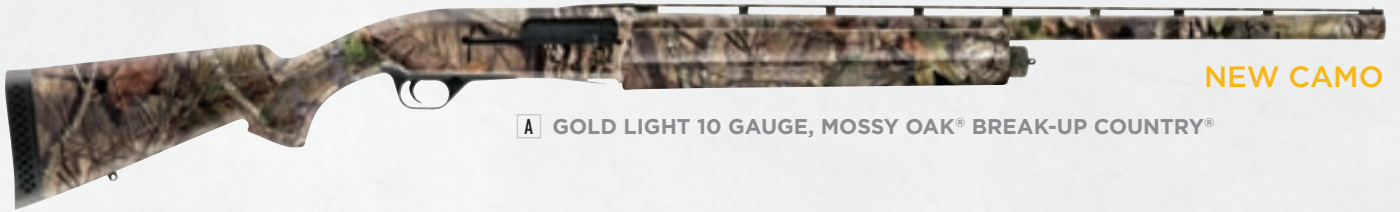

A GOLD LIGHT 10 GAUGE, MOSSY OAK® BREAK-UP COUNTRY®



B BPS 10 GAUGE



C NWTf® BPS 10 GAUGE, MOSSY OAK® BREAK-UP COUNTRY®

A GOLD LIGHT 10 GAUGE, MOSSY OAK BREAK-UP COUNTRY

RECEIVER Aluminum alloy **BARREL** Ventilated rib **ACTION** Gas-operated autoloader • 3-1/2" chamber • Magazine capacity - Four in the magazine plus one in the chamber **STOCK** Composite • Dura-Touch Armor Coating • Mossy Oak® camo finishes **FEATURES** Three Standard Invector choke tubes • National Wild Turkey Federation model includes HiViz® 4-in-1 fiber-optic sight and NWTf® logo on the buttstock • Receiver is drilled and tapped for scope mount **IDEAL USAGE** Waterfowl/Turkey

B BPS 10 GAUGE

RECEIVER Forged and machined steel **BARREL** Ventilated rib **ACTION** Bottom ejection • Dual steel action bars • 3-1/2" chamber • Top-tang safety • Magazine capacity - Four in the magazine plus one in the chamber **STOCK** Composite • Dura-Touch Armor Coating • Mossy Oak® camo finishes • Matte black on Stalker **FEATURES** Three Standard Invector choke tubes • Brass front bead sight **IDEAL USAGE** Waterfowl

C NWTf BPS 10 GAUGE, MOSSY OAK BREAK-UP COUNTRY

RECEIVER Forged and machined steel • Drilled and tapped for scope mounts **BARREL** Ventilated rib • 24" length **ACTION** Bottom ejection • Dual steel action bars • 3-1/2" chamber • Top-tang safety • Magazine capacity - Four in the magazine plus one in the chamber **STOCK** Composite • Dura-Touch Armor Coating • Mossy Oak® Break-Up Country® camo finish • NWTf® logo on the buttstock **FEATURES** Standard Invector X-Full Turkey choke tube • HiViz® 4-in-1 fiber-optic sight • Endorsed by the National Wild Turkey Federation **IDEAL USAGE** Turkey

NEW 2015	MODEL	GAUGE	CODE NUMBER	SUGGESTED RETAIL	BARREL LENGTH Inches	CHOKES Included	CHAMBER Inches	AVERAGE WEIGHT lbs./Oz.	OVERALL LENGTH Inches	DROP AT COMB Inches	DROP AT HEEL Inches	LENGTH OF PULL Inches	RIB WIDTH Inches
GOLD LIGHT 10 GAUGE, MOSSY OAK BREAK-UP COUNTRY													
A	• MOBUC	10	011289113	1,739.99	28	F,M,IC	3-1/2	9 / 10	50	1-1/2	2-1/2	14-1/2	5/16
	• MOBUC	10	011289114	1,739.99	26	F,M,IC	3-1/2	9 / 9	48	1-1/2	2-1/2	14-1/2	5/16
	• NWTf/MOBUC	10	011288115	1,869.99	24	XF Turkey	3-1/2	9 / 4	46	1-1/2	2-1/2	14-1/2	5/16
	• MOSGB	10	011287113	1,739.99	28	F,M,IC	3-1/2	9 / 10	50	1-1/2	2-1/2	14-1/2	5/16
	• MOSGB	10	011287114	1,739.99	26	F,M,IC	3-1/2	9 / 9	48	1-1/2	2-1/2	14-1/2	5/16
BPS 10 GAUGE (SHOWN IN MOSSY OAK SHADOW GRASS BLADES)													
	• Stalker	10	012212113	799.99	28	F,M,IC	3-1/2	10 / 9	50	1-1/2	2-1/2	14-1/4	5/16
	• Stalker	10	012212114	799.99	26	F,M,IC	3-1/2	10 / 8	48	1-1/2	2-1/2	14-1/4	5/16
	• MOBUC	10	012279113	949.99	28	F,M,IC	3-1/2	10 / 9	50	1-1/2	2-1/2	14-1/4	5/16
	• MOBUC	10	012279114	949.99	26	F,M,IC	3-1/2	10 / 8	48	1-1/2	2-1/2	14-1/4	5/16
B	• MOSGB	10	012271113	949.99	28	F,M,IC	3-1/2	10 / 9	50	1-1/2	2-1/2	14-1/4	5/16
	• MOSGB	10	012271114	949.99	26	F,M,IC	3-1/2	10 / 8	48	1-1/2	2-1/2	14-1/4	5/16
NWTf BPS 10 GAUGE, MOSSY OAK BREAK-UP COUNTRY													
C	• MOBUC	10	012280115	1,029.99	24	XF Turkey	3-1/2	10 / 3	46	1-1/2	2-1/2	14-1/4	5/16



THE SHOTGUN THAT THINKS IT'S A RIFLE.

Featuring a crisp trigger, smooth bolt operation, short 60° bolt lift and detachable box magazine, the A-Bolt shotgun shares many of the same features that made the A-Bolt rifle so popular. Most importantly, these traits provide a high level of reliability and accuracy.



BARREL

- Rifled 1 in 28" twist barrel.
- Designed exclusively for use with sabot-type slugs.
- Superb accuracy with 1-1/2" groups or better typical at 100 yards.



PERFORMANCE

- Smooth, anti-bind bolt design.
- Non-rotating bolt sleeve.

ALL BROWNING FIREARMS ARE SHIPPED WITH A FREE LOCKING DEVICE TO ASSIST IN THE SAFE STORAGE OF FIREARMS.



COMPOSITE STOCK

- Rugged composite stock.
- Right-hand palm swell pistol grip.
- Checkered gripping surfaces and Dura-Touch Armor Coating provide security in all conditions.



DETACHABLE MAGAZINE

- Detachable magazine on a hinged floorplate for fast reloads.
- 2 + 1 capacity.



D A-BOLT SHOTGUN STALKER



NEW CAMO

E A-BOLT SHOTGUN, MOSSY OAK® BREAK-UP COUNTRY®



F A-BOLT SHOTGUN HUNTER



D A-BOLT SHOTGUN STALKER

E A-BOLT SHOTGUN, MOSSY OAK BREAK-UP COUNTRY

RECEIVER Steel • Low-luster blued finish • Drilled and tapped for scope mounts **BARREL** Low-luster blued finish • Thick-walled, fully rifled for slug and sabot ammunition **ACTION** 3" chamber • Bolt-action • 60° bolt lift • Detachable two-round magazine • Top-tang safety **STOCK** Composite • Checkered gripping surfaces • Matte black or Mossy Oak® Break-Up Country® camo finish • Dura-Touch Armor Coating **FEATURES** Sling swivel studs installed • Recoil pad • TRUGLO®/Marble Arms® fiber-optic front sight • Rear sight is adjustable for windage and elevation

F A-BOLT SHOTGUN HUNTER

RECEIVER Steel • Low-luster blued finish • Drilled and tapped for scope mounts **BARREL** Low-luster blued finish • Thick-walled, fully rifled for slug and sabot ammunition **ACTION** 3" chamber • Bolt-action • 60° bolt lift • Detachable two-round magazine • Top-tang safety **STOCK** Satin finish walnut • Checkered **FEATURES** Sling swivel studs installed • Recoil pad • TRUGLO®/Marble Arms® fiber-optic front sight • Rear sight is adjustable for windage and elevation

NEW 2015	GAUGE	CODE NUMBER	SUGGESTED RETAIL	BARREL LENGTH Inches	CHAMBER Inches	AVERAGE WEIGHT Lbs. / Oz.	OVERALL LENGTH Inches	SIGHT RADIUS Inches	DROP AT COMB Inches	DROP AT HEEL Inches	LENGTH OF PULL Inches	RATE OF TWIST Inches
A-BOLT SHOTGUN STALKER												
D	12	015003120	1,149.99	22	3	7 / 0	43-3/4	15-7/8	5/8	1/2	14	28
A-BOLT SHOTGUN, MOSSY OAK BREAK-UP COUNTRY												
E	12	015008120	1,299.99	22	3	7 / 0	43-3/4	15-7/8	5/8	1/2	14	28
A-BOLT SHOTGUN HUNTER												
F	12	015001120	1,279.99	22	3	7 / 2	43-3/4	15-7/8	5/8	1/2	14	28

MODEL	GAUGE	CODE NUMBER	SUGGESTED RETAIL	BARREL LENGTH Inches	CHOKES Included	CHAMBER Inches
A5 EXTRA BARRELS						
Hunter	12	1118002003	479.99	30	F,M,I,C	3-1/2
Hunter	12	1118002004	479.99	28	F,M,I,C	3-1/2
Hunter	12	1118002005	479.99	26	F,M,I,C	3-1/2
Stalker	12	1118012003	479.99	30	F,M,I,C	3-1/2
Stalker	12	1118012004	479.99	28	F,M,I,C	3-1/2
Stalker	12	1118012005	479.99	26	F,M,I,C	3-1/2
MOINF	12	1118022003	519.99	30	F,M,I,C	3-1/2
MOINF	12	1118022004	519.99	28	F,M,I,C	3-1/2
MOINF	12	1118022005	519.99	26	F,M,I,C	3-1/2
MOSGB	12	1118182003	519.99	30	F,M,I,C	3-1/2
MOSGB	12	1118182004	519.99	28	F,M,I,C	3-1/2
MOSGB	12	1118182005	519.99	26	F,M,I,C	3-1/2
Hunter	12	1118003003	399.99	30	F,M,I,C	3
Hunter	12	1118003004	399.99	28	F,M,I,C	3
Hunter	12	1118003005	399.99	26	F,M,I,C	3
Stalker	12	1118013003	399.99	30	F,M,I,C	3
Stalker	12	1118013004	399.99	28	F,M,I,C	3
Stalker	12	1118013005	399.99	26	F,M,I,C	3
MOINF	12	1118023003	439.99	30	F,M,I,C	3
MOINF	12	1118023004	439.99	28	F,M,I,C	3
MOINF	12	1118023005	439.99	26	F,M,I,C	3
MOSGB	12	1118183003	439.99	30	F,M,I,C	3
MOSGB	12	1118183004	439.99	28	F,M,I,C	3
MOSGB	12	1118183005	439.99	26	F,M,I,C	3
A5 shotgun barrels listed in this chart are designed to fit A5 shotguns built in 2012 and later. They are not compatible with any other Browning autoloading shotgun.						
SILVER EXTRA BARRELS						
Hunter	12	1113502004	419.99	28	F,M,I,C	3-1/2
Hunter	12	1113502005	419.99	26	F,M,I,C	3-1/2
Stalker	12	1113512004	419.99	28	F,M,I,C	3-1/2
Stalker	12	1113512005	419.99	26	F,M,I,C	3-1/2
MONBU	12	1113522006	439.99	24	F,M,I,C	3-1/2
MOSGB	12	1114032004	439.99	28	F,M,I,C	3-1/2
MOSGB	12	1114032005	439.99	26	F,M,I,C	3-1/2
Hunter	12	1113503003	339.99	30	F,M,I,C	3
Hunter	12	1113503004	339.99	28	F,M,I,C	3
Hunter	12	1113503005	339.99	26	F,M,I,C	3
Hunter/Micro*	20	1113506004	339.99	28	F,M,I,C	3
Hunter/Micro*	20	1113506005	339.99	26	F,M,I,C	3
Deer Satin	20	111371621	419.99	22	Rif. Bbl./Cant.	3
Deer MONBU**	12	111379321	539.99	22	Rif. Bbl./Cant.	3
Deer MOINF**	12	111387321	539.99	22	Rif. Bbl./Cant.	3
Deer Stalker**	12	111380321	459.99	22	Rif. Bbl./Cant.	3
*20 gauge Silver shotgun barrels fit on Silver Hunter and Silver Micro 20 gauge models. **To prevent damage to forearms, all Silver rifled cantilever barrels are delivered with a new forearm specifically designed to fit over the thicker, rifled barrel walls.						
GOLD EXTRA BARRELS						
- 12 & 20 GAUGE						
Deer Hunter	12	111106319	435.99	22	Rif. Tube/Cant.	3
Fusion	20	111141604	480.99	28	F,M,I,C	3
Fusion	20	111141605	480.99	26	F,M,I,C	3
Evolve Sporting	12	111262428	552.99	28	F,M,I,C	2-3/4
- 10 GAUGE						
MOINF	10	111280113	354.99	28	F,M,I,C	3-1/2
MOINF	10	111280114	354.99	26	F,M,I,C	3-1/2
MOINF	10	111280115	354.99	24	XF Turkey	3-1/2
MAXUS EXTRA BARRELS						
Hunter	12	111608203	419.99	30	F,M,I,C	3-1/2
Hunter	12	111608204	419.99	28	F,M,I,C	3-1/2
Hunter	12	111608205	419.99	26	F,M,I,C	3-1/2
Stalker	12	111600204	419.99	28	F,M,I,C	3-1/2
Stalker	12	111600205	419.99	26	F,M,I,C	3-1/2
MODB	12	111601204	439.99	28	F,M,I,C	3-1/2
MOSGB	12	111645204	439.99	28	F,M,I,C	3-1/2
MOSGB	12	111645205	439.99	26	F,M,I,C	3-1/2
Hunter	12	111608303	339.99	30	F,M,I,C	3
Hunter	12	111608304	339.99	28	F,M,I,C	3
Hunter	12	111608305	339.99	26	F,M,I,C	3
Stalker	12	111600304	339.99	28	F,M,I,C	3
Stalker	12	111600305	339.99	26	F,M,I,C	3
MODB	12	111601304	379.99	28	F,M,I,C	3
MODB	12	111601305	379.99	26	F,M,I,C	3
MOSGB	12	111645304	379.99	28	F,M,I,C	3
MOSGB	12	111645305	379.99	26	F,M,I,C	3
MOINF	12	111644304	379.99	28	F,M,I,C	3
MOINF	12	111644305	379.99	26	F,M,I,C	3
Rifled Deer Stalker†	12	111620321	459.99	22	Rif. Bbl./Cant.	3
†To prevent damage to forearms, all Maxus rifled cantilever barrels are delivered with a new forearm specifically designed to fit over the thicker rifled barrel walls.						

MODEL	GAUGE	CODE NUMBER	SUGGESTED RETAIL	BARREL LENGTH Inches	CHOKES Included	CHAMBER Inches
BPS EXTRA BARRELS						
- 10 GAUGE						
Hunter	10	111211113	309.99	28	F,M,I,C	3-1/2
Hunter	10	111211114	309.99	26	F,M,I,C	3-1/2
Hunter	10	111211115	309.99	24	F,M,I,C	3-1/2
Stalker	10	111212113	309.99	28	F,M,I,C	3-1/2
Stalker	10	111212114	309.99	26	F,M,I,C	3-1/2
Stalker	10	111212115	309.99	24	F,M,I,C	3-1/2
MONSG	10	111220113	339.99	28	F,M,I,C	3-1/2
MONSG	10	111220114	339.99	26	F,M,I,C	3-1/2
MONSG	10	111220115	339.99	24	F,M,I,C	3-1/2
MONBU	10	111219113	339.99	28	F,M,I,C	3-1/2
MONBU	10	111219114	339.99	26	F,M,I,C	3-1/2
MONBU	10	111219115	339.99	24	XF Turkey	3-1/2
MOINF	10	111257113	339.99	28	F,M,I,C	3-1/2
MOINF	10	111257114	339.99	26	F,M,I,C	3-1/2
MOINF	10	111257115	339.99	24	XF Turkey	3-1/2
MODB	10	111243113	339.99	28	F,M,I,C	3-1/2
MODB	10	111243114	339.99	26	F,M,I,C	3-1/2
MOSGB	10	111271113	339.99	28	F,M,I,C	3-1/2
MOSGB	10	111271114	339.99	26	F,M,I,C	3-1/2
- 12 GAUGE						
Hunter	12	111211204	309.99	28	F,M,I,C	3-1/2
Hunter	12	111211205	309.99	26	F,M,I,C	3-1/2
Hunter	12	111211206	309.99	24	F,M,I,C	3-1/2
Stalker	12	111212204	309.99	28	F,M,I,C	3-1/2
Stalker	12	111212205	309.99	26	F,M,I,C	3-1/2
Stalker	12	111212206	309.99	24	F,M,I,C	3-1/2
MONBU	12	111219204	339.99	28	F,M,I,C	3-1/2
MONBU	12	111219205	339.99	26	F,M,I,C	3-1/2
MOINF	12	111257204	339.99	28	F,M,I,C	3-1/2
MOINF	12	111257205	339.99	26	F,M,I,C	3-1/2
MOINF	12	111257206	339.99	24	XF Turkey	3-1/2
MONSG	12	111220205	339.99	26	F,M,I,C	3-1/2
MODB	12	111243205	339.99	26	F,M,I,C	3-1/2
MOSGB	12	111271204	339.99	28	F,M,I,C	3-1/2
MOSGB	12	111271205	339.99	26	F,M,I,C	3-1/2
Hunter	12	111211304	269.99	28	F,M,I,C	3
Hunter	12	111211305	269.99	26	F,M,I,C	3
Hunter	12	111211306	269.99	24	F,M,I,C	3
Stalker	12	111212303	269.99	30	F,M,I,C	3
Stalker	12	111212304	269.99	28	F,M,I,C	3
Stalker	12	111212305	269.99	26	F,M,I,C	3
Stalker	12	111212306	269.99	24	F,M,I,C	3
Upland Special	12	111216307	269.99	22	F,M,I,C	3
MOINF	12	111257304	299.99	28	F,M,I,C	3
MOINF	12	111257305	299.99	26	F,M,I,C	3
MOINF	12	111257306	299.99	24	XF Turkey	3
MONSG	12	111220306	299.99	24	F,M,I,C	3
MODB	12	111243304	299.99	28	F,M,I,C	3
MODB	12	111243305	299.99	26	F,M,I,C	3
MOSGB	12	111271304	299.99	28	F,M,I,C	3
MOSGB	12	111271305	299.99	26	F,M,I,C	3
- 16 GAUGE, 20 GAUGE, 28 GAUGE & .410 BORE						
Hunter	20	111211604	269.99	28	F,M,I,C	3
Hunter	20	111211605	269.99	26	F,M,I,C	3
Hunter	20	111211607	269.99	22	F,M,I,C	3
Hunter	.410	111211914	269.99	26	F,M,I,C	3
Hunter	16	111211513	269.99	28	F,M,I,C	2-3/4
Hunter	16	111211514	269.99	26	F,M,I,C	2-3/4
Hunter	28	111211813	269.99	28	F,M,I,C	2-3/4
Hunter	28	111211814	269.99	26	F,M,I,C	2-3/4
- GAME GUN						
Deer Special††	20	111214621	399.99	22	Rif. Bbl./Cant.	3
Deer Special†††	12	111214324	399.99	22	Rif. Bbl./Cant.	3
††Satin, cantilever scope mount. †††Satin, with sight.						

IMPORTANT: DO NOT ATTEMPT THE USE OF 3-1/2" CHAMBERED BARRELS WITH 3" RECEIVERS OR 3" CHAMBERED BARRELS WITH 3-1/2" RECEIVERS.



TOTAL ACCURACY.

With new models and calibers, there is a Browning X-Bolt rifle for every customer. All feature precision construction for tack-driving performance right from the box. Pick up an X-Bolt and pull the trigger.



FEATHERTRIGGER™

FEATHER TRIGGER

- For precise shooting there is absolutely no substitute for a crisp, predictable trigger.
- The X-Bolt's three-lever Feather Trigger provides a clean, crisp pull with no take-up or creep and minimal overtravel.
- The trigger is screw adjustable from 3 to 5 lbs. and factory pre-set at approximately 3-1/2 - 4 lbs.
- An alloy trigger housing contains hard chromed steel components that are highly polished on all critical contact surfaces.

X-BOLT RIFLES. PERFORMANCE IS A FEATURE.

- The Browning X-Bolt is a modern bolt-action rifle with a host of innovative features.
- The total accuracy advantage gives added confidence in the field to make longer shots.
- Inflex recoil pad softens recoil and allows faster, more accurate second shots.
- Fast-operating 60° bolt lift offers fast cycling and prevents interference from the scope when working the bolt.
- The bolt unlock button allows the bolt to be cycled with the safety in the on safe position.
- Bolt design is simple, with three locking lugs for superior lock-up.

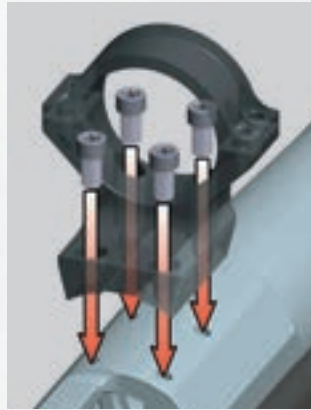

X-LOCK SCOPE MOUNTING SYSTEM

- Securely mounted optics are essential for accuracy and precision on any rifle.
- X-Lock mounts feature a four screws per base design that replaces the traditional two screw system.
- Offers more accurate placement and more secure attachment to the receiver.

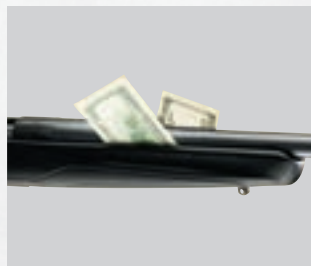

FREE-FLOATING BARREL

- Every X-Bolt is individually bedded into the stock for a true free-floating barrel, not bedded using a master receiver like the competition.
- The X-Bolt barrel is free-floated by bedding the front and rear of the action for stability.
- Maintains barrel to stock spacing for consistent accuracy.
- The recessed muzzle crown helps protect the rifling from damage.
- Barrels are triple checked for interior finish, straightness and air-gauged for uniformity.
- Hand-reamed chamber for precision accuracy.



BOLT UNLOCK BUTTON

- The bolt unlock button works in conjunction with the top-tang safety to provide an extra margin of safety when checking and unloading the chamber.
- Located on top of the bolt handle, the bolt unlock button allows the bolt to be unlocked and opened with the tang safety in the on safe position.
- The convenient tang safety blocks the trigger sear and features a firing pin block for added security.

PERSONALIZED ENGRAVING ON THE X-BOLT

- The bolt can be personalized with an individual's name. Call (800) 333-3288.



Block



Script

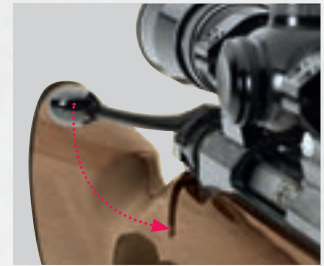

60° BOLT LIFT

- Short 60° bolt lift is fast cycling and the hand easily clears the scope.
- The bolt is machined from solid steel bar stock for strength and custom rifle precision.
- Three locking lugs provide exceptional bolt strength.



ROTARY MAGAZINE

- The unique rotary magazine is removable, durable, easy to load and feeds rounds from the center line — not off to the side like other rifles — for straight to the chamber feeds.
- Unique design holds U.S. patent numbers: 8,156,675; 8,484,875 and 8,745,912



TANG SAFETY

- Tang safety is easy to reach with the thumb.

ALL BROWNING FIREARMS ARE SHIPPED WITH A FREE LOCKING DEVICE TO ASSIST IN THE SAFE STORAGE OF FIREARMS.



A X-BOLT ECLIPSE HUNTER

NEW



B X-BOLT ECLIPSE TARGET

NEW

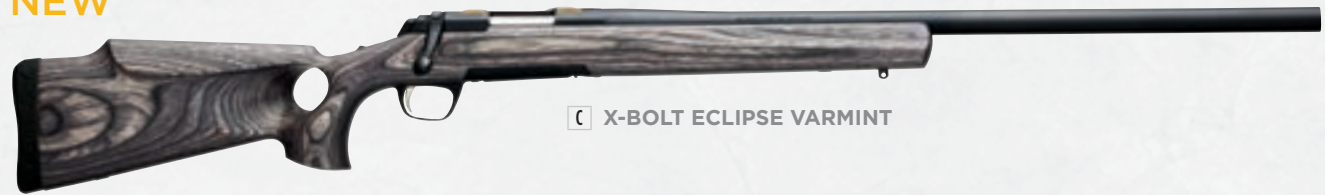

C X-BOLT ECLIPSE VARMINT

A X-BOLT ECLIPSE HUNTER

RECEIVER Steel • Matte blued finish • Glass bedded • Drilled and tapped for scope mounts **BARREL** Matte blued finish • Free-floating • Hand chambered • Target crown **ACTION** Bolt-action • 60° bolt lift • Adjustable Feather Trigger • Detachable rotary magazine • Top-tang safety • Bolt unlock button **STOCK** Laminated gray satin varnish finish • Thumbhole grip • Monte Carlo cheekpiece • Checkered **FEATURES** Sling swivel studs installed • Inflex recoil pad (Scope and mounts not included)

B X-BOLT ECLIPSE TARGET **C X-BOLT ECLIPSE VARMINT**

RECEIVER Steel • Matte blued finish • Glass bedded • Drilled and tapped for scope mounts **BARREL** Heavy bull • Matte blued finish • Free-floating • Hand chambered • Target crown **ACTION** Bolt-action • 60° bolt lift • Adjustable Feather Trigger is factory set at 3 to 3-1/2 lbs. • Detachable rotary magazine • Top-tang safety • Bolt unlock button **STOCK** Laminated gray satin varnish finish • Thumbhole grip • Raised cheekpiece **FEATURES** Swivel stud for bipod • Two QD swivel cups • Inflex recoil pad

NEW 2015	CALIBER	CODE NUMBER	SUGGESTED RETAIL	ACTION SS / Super Short S / Short L / Long	BARREL LENGTH Inches	TOTAL CAPACITY Includes one in the chamber	AVERAGE WEIGHT Lbs. / Oz.	OVERALL LENGTH Inches	DROP AT COMB Inches	DROP AT HEEL Inches	LENGTH OF PULL Inches	RATE OF TWIST Inches
X-BOLT ECLIPSE HUNTER												
	243 Win.	035299211	1,019.99	S	22	5	6 / 7	42-1/8	5/8	1/2	13-3/4	10
	308 Win.	035299218	1,019.99	S	22	5	6 / 7	42-1/8	5/8	1/2	13-3/4	12
	7mm-08 Rem.	035299216	1,019.99	S	22	5	6 / 7	42-1/8	5/8	1/2	13-3/4	10
	270 WSM	035299248	1,059.99	S	23	4	7 / 2	43-1/8	5/8	1/2	13-3/4	10
	300 WSM	035299246	1,059.99	S	23	4	7 / 2	43-1/8	5/8	1/2	13-3/4	10
	25-06 Rem.	035299223	1,019.99	L	24	5	7 / 6	44-7/8	5/8	1/2	13-3/4	10
	270 Win.	035299224	1,019.99	L	22	5	7 / 4	42-7/8	5/8	1/2	13-3/4	10
A	30-06 Sprg.	035299226	1,019.99	L	22	5	7 / 5	42-7/8	5/8	1/2	13-3/4	10
	7mm Rem. Mag.	035299227	1,059.99	L	26	4	7 / 8	46-7/8	5/8	1/2	13-3/4	9-1/2
	300 Win. Mag.	035299229	1,059.99	L	26	4	7 / 8	46-7/8	5/8	1/2	13-3/4	10
X-BOLT ECLIPSE TARGET												
B	• 6.5 Creedmoor	035337282	1,069.99	S	28	5	10 / 3	48-1/8	5/8	1/2	13-3/4	8
	• 308 Win.	035337218	1,069.99	S	28	5	10 / 0	48-1/8	5/8	1/2	13-3/4	10
X-BOLT ECLIPSE VARMINT												
	• 204 Rgr.	035338274	1,069.99	SS	26	6	9 / 6	45-5/8	5/8	1/2	13-3/4	12
C	• 223 Rem.	035338208	1,069.99	SS	26	6	9 / 5	45-5/8	5/8	1/2	13-3/4	12
	• 22-250 Rem.	035338209	1,069.99	SS	26	5	9 / 5	45-5/8	5/8	1/2	13-3/4	14



A X-BOLT MEDALLION

**NEW TWIST RATES
223 REM. AND 22-250 REM.**



B X-BOLT HIGH GRADE HUNTER
FULL LINE DEALER

NEW



C X-BOLT HUNTER, FULL LINE DEALER



A X-BOLT MEDALLION

RECEIVER Steel • Engraved with polished blued finish • Glass bedded • Drilled and tapped for scope mounts **BARREL** Blued finish • Free-floating • Hand chambered • Target crown
ACTION Bolt-action • 60° bolt lift • Adjustable Feather Trigger • Detachable rotary magazine • Top-tang safety • Bolt unlock button **STOCK** Gloss finish checkered walnut • Rosewood fore-end grip and pistol grip cap **FEATURES** Sling swivel studs • Inflex recoil pad (Scope and mounts not included) • 375 H&H Mag. includes open sights with 18" sight radius

B X-BOLT HIGH GRADE HUNTER, FULL LINE DEALER **C X-BOLT HUNTER, FULL LINE DEALER**

RECEIVER Steel • Matte blued finish • Glass bedded • Drilled and tapped for scope mounts **BARREL** Matte blued finish • Free-floating • Hand chambered • Target crown • Hunter has round barrel • High Grade Hunter has full octagon barrel • **ACTION** Bolt-action • 60° bolt lift • Adjustable Feather Trigger • Detachable rotary magazine • Top-tang safety • Bolt unlock button **STOCK** Raised cheekpiece • Hunter has satin finish checkered walnut • High Grade Hunter has oil finish Grade III/IV checkered walnut with rosewood fore-end grip and pistol grip caps **FEATURES** Sling swivel studs • Inflex recoil pad • Available only from Browning Full Line and Medallion Dealers

NEW 2015	CALIBER	RIGHT-HAND MODELS		NEW 2015	LEFT-HAND MODELS		ACTION SS / Super-Short S / Short, L / Long	BARREL LENGTH Inches	TOTAL CAPACITY Includes one in the chamber	AVERAGE WEIGHT lbs., oz.	OVERALL LENGTH Inches	DROP AT COMB Inches	DROP AT HEEL Inches	LENGTH OF PULL Inches	RATE OF TWIST Inches
		CODE NUMBER	SUGGESTED RETAIL		CODE NUMBER	SUGGESTED RETAIL									
X-BOLT MEDALLION															
	• 223 Rem.	035344208	1,039.99		—	—	SS	22	6	6 / 6	41-1/2	11/16	1/2	13-5/8	8
	• 22-250 Rem.	035344209	1,039.99		—	—	SS	22	5	6 / 6	41-1/2	11/16	1/2	13-5/8	9
	243 Win.	035200211	1,039.99		035253211	1,069.99	S	22	5	6 / 8	42	11/16	1/2	13-5/8	10
	308 Win.	035200218	1,039.99		035253218	1,069.99	S	22	5	6 / 8	42	11/16	1/2	13-5/8	12
	270 WSM	035200248	1,079.99		035253248	1,099.99	S	23	4	6 / 11	43	11/16	1/2	13-5/8	10
	7mm WSM	035200249	1,079.99		—	—	S	23	4	6 / 11	43	11/16	1/2	13-5/8	9-1/2
A	300 WSM	035200246	1,079.99		035253246	1,099.99	S	23	4	6 / 11	43	11/16	1/2	13-5/8	10
	325 WSM	035200277	1,079.99		—	—	S	23	4	6 / 11	43	11/16	1/2	13-5/8	10
	25-06 Rem.	035200223	1,039.99		—	—	L	24	5	6 / 14	44-3/4	11/16	1/2	13-5/8	10
	270 Win.	035200224	1,039.99		035253224	1,069.99	L	22	5	6 / 12	42-3/4	11/16	1/2	13-5/8	10
	280 Rem.	035200225	1,039.99		—	—	L	22	5	6 / 12	42-3/4	11/16	1/2	13-5/8	10
	30-06 Sprg.	035200226	1,039.99		035253226	1,069.99	L	22	5	6 / 12	42-3/4	11/16	1/2	13-5/8	10
	7mm Rem. Mag.	035200227	1,079.99		035253227	1,099.99	L	26	4	7 / 0	46-3/4	11/16	1/2	13-5/8	9-1/2
	300 Win. Mag.	035200229	1,079.99		035253229	1,099.99	L	26	4	7 / 0	46-3/4	11/16	1/2	13-5/8	10
	338 Win. Mag.	035200231	1,079.99		—	—	L	26	4	7 / 0	46-3/4	11/16	1/2	13-5/8	10
	375 H&H Mag.	035200132	1,079.99		—	—	L	24	4	7 / 0	44-3/4	11/16	1/2	13-5/8	12

X-BOLT HIGH GRADE HUNTER, FULL LINE DEALER				X-BOLT HUNTER, FULL LINE DEALER											
	• 243 Win.	035341211	1,469.99		035281211	1,039.99	S	22	5	6 / 8	42	3/4	1-7/16	13-5/8	10
	7mm-08 Rem.	—	—		035281216	1,039.99	S	22	5	6 / 8	42	3/4	1-7/16	13-5/8	9-1/2
	• 308 Win.	035341218	1,469.99	C	035281218	1,039.99	S	22	5	6 / 8	42	3/4	1-7/16	13-5/8	12
	• 270 WSM	035341248	1,509.99		035281248	1,049.99	S	23	4	6 / 11	43	3/4	1-7/16	13-5/8	10
	• 300 WSM	035341246	1,509.99		035281246	1,049.99	S	23	4	6 / 11	43	3/4	1-7/16	13-5/8	10
	• 270 Win.	035341224	1,469.99		035281224	1,039.99	L	22	5	6 / 12	42-3/4	3/4	1-7/16	13-5/8	10
	• 30-06 Sprg.	035341226	1,469.99		035281226	1,039.99	L	22	5	6 / 12	42-3/4	3/4	1-7/16	13-5/8	10
	• 7mm Rem. Mag.	035341227	1,509.99		035281227	1,049.99	L	26	4	7 / 0	46-3/4	3/4	1-7/16	13-5/8	9-1/2
B	• 300 Win. Mag.	035341229	1,509.99		035281229	1,049.99	L	26	4	7 / 0	46-3/4	3/4	1-7/16	13-5/8	10



**NEW TWIST RATES
223 REM. AND 22-250 REM.**

**D X-BOLT
WHITE GOLD MEDALLION**



White Gold Medallion Engraving, Right



White Gold Medallion Engraving, Left



**E X-BOLT RMEF®
WHITE GOLD MEDALLION**



**NEW
CALIBER**

RMEF Logo Grip Cap



**F X-BOLT RMEF®
SPECIAL HUNTER**



**NEW
CALIBER**

RMEF Logo Grip Cap

D X-BOLT WHITE GOLD MEDALLION E X-BOLT RMEF WHITE GOLD MEDALLION

RECEIVER Stainless steel • Polished finish • Glass bedded • Drilled and tapped for scope mounts • Scroll engraving on front and rear receiver **BARREL** Stainless steel • Polished stainless finish • Free-floating • Hand chambered • Target crown **ACTION** Bolt-action • 60° bolt lift • Adjustable Feather Trigger • Detachable rotary magazine • Top-tang safety • Bolt unlock button **STOCK** Gloss finish checkered walnut • Raised cheekpiece • Rosewood fore-end grip and pistol grip caps • RMEF® model features logo inset grip cap **FEATURES** Sling swivel studs • Inflex recoil pad

F X-BOLT RMEF SPECIAL HUNTER

RECEIVER Steel • Low-luster blued finish • Glass bedded • Drilled and tapped for scope mounts **BARREL** Matte blued finish • Free-floating • Hand chambered • Target crown **ACTION** Bolt-action • 60° bolt lift • Adjustable Feather Trigger • Detachable rotary magazine • Top-tang safety • Bolt unlock button **STOCK** Satin finish walnut • Raised cheekpiece • Checkered • Rosewood grip cap • RMEF® logo inset grip cap **FEATURES** Sling swivel studs • Inflex recoil pad

NEW 2015	CALIBER	CODE NUMBER	SUGGESTED RETAIL	ACTION SS/Super Short S/Short L/Long	BARREL LENGTH Inches	TOTAL CAPACITY Includes one in the chamber	AVERAGE WEIGHT lbs./Oz.	OVERALL LENGTH Inches	DROP AT COMB Inches	DROP AT HEEL Inches	LENGTH OF PULL Inches	RATE OF TWIST Inches
X-BOLT WHITE GOLD MEDALLION												
•	223 Rem.	035345208	1,419.99	SS	22	6	6 / 6	41-1/2	3/4	1-7/16	13-5/8	8
•	22-250 Rem.	035235209	1,419.99	SS	22	5	6 / 6	41-1/2	3/4	1-7/16	13-5/8	9
D	243 Win.	035235211	1,419.99	S	22	5	6 / 8	42	3/4	1-7/16	13-5/8	10
	7mm-08 Rem.	035235216	1,419.99	S	22	5	6 / 8	42	3/4	1-7/16	13-5/8	9-1/2
	308 Win.	035235218	1,419.99	S	22	5	6 / 8	42	3/4	1-7/16	13-5/8	12
	270 WSM	035235248	1,459.99	S	23	4	6 / 8	43	3/4	1-7/16	13-5/8	10
	7mm WSM	035235249	1,459.99	S	23	4	6 / 11	43	3/4	1-7/16	13-5/8	9-1/2
	300 WSM	035235246	1,459.99	S	23	4	6 / 11	43	3/4	1-7/16	13-5/8	10
	25-06 Rem.	035235223	1,419.99	L	24	5	6 / 14	44-3/4	3/4	1-7/16	13-5/8	10
	270 Win.	035235224	1,419.99	L	22	5	6 / 12	42-3/4	3/4	1-7/16	13-5/8	10
	280 Rem.	035235225	1,419.99	L	22	5	6 / 12	42-3/4	3/4	1-7/16	13-5/8	10
	30-06 Sprg.	035235226	1,419.99	L	22	5	6 / 12	42-3/4	3/4	1-7/16	13-5/8	10
	7mm Rem. Mag.	035235227	1,459.99	L	26	4	7 / 0	46-3/4	3/4	1-7/16	13-5/8	9-1/2
	300 Win. Mag.	035235229	1,459.99	L	26	4	7 / 0	46-3/4	3/4	1-7/16	13-5/8	10
	338 Win. Mag.	035235231	1,459.99	L	26	4	7 / 0	46-3/4	3/4	1-7/16	13-5/8	10
X-BOLT RMEF WHITE GOLD MEDALLION												
E	• 300 Win. Mag.	035217229	1,539.99	L	26	4	7 / 0	46-3/4	3/4	1-7/16	13-5/8	10
X-BOLT RMEF SPECIAL HUNTER												
F	• 300 WSM	035218246	1,109.99	S	23	4	6 / 11	43	3/4	1-7/16	13-5/8	10

THE FEEL OF TRADITION.

Composite stocks have become the material of choice for many gun makers, but there is something special about the warmth, beauty and feel of finely finished walnut in the hands that can't be beat. We offer the X-Bolt in several wood-stocked configurations, all bedded at the recoil lug and all feature a rear action screw to help ensure accuracy.



A X-BOLT HUNTER

**NEW TWIST RATES
223 REM. AND 22-250 REM.**



B X-BOLT MICRO MIDAS

**NEW CALIBERS
NEW TWIST RATE
22-250 REM.**

A X-BOLT HUNTER

RECEIVER Steel • Matte blued finish • Glass bedded • Drilled and tapped for scope mounts **BARREL** Matte blued finish • Free-floating • Hand chambered • Target crown **ACTION** Bolt-action • 60° bolt lift • Adjustable Feather Trigger • Detachable rotary magazine • Top-tang safety • Bolt unlock button **STOCK** Satin finish checkered walnut **FEATURES** Sling swivel studs • Inflex recoil pad • 375 H&H Mag. includes open sights with 18" sight radius (Scope and mounts not included)

B X-BOLT MICRO MIDAS

RECEIVER Steel • Matte blued finish • Glass bedded • Drilled and tapped for scope mounts **BARREL** Matte blued finish • Free-floating • Hand chambered • Target crown **ACTION** Bolt-action • 60° bolt lift • Adjustable Feather Trigger • Detachable rotary magazine • Top-tang safety • Bolt unlock button **STOCK** Satin finish checkered walnut **FEATURES** Sling swivel studs • Inflex recoil pad • Three 1/4" stock spacers **ELIGIBLE FOR THE GROWTH INSURANCE PROGRAM** See page 2 for details.

NEW 2015	CALIBER	RIGHT-HAND MODELS		LEFT-HAND MODELS		ACTION SS / Super Short S / Short, L / Long	BARREL LENGTH Inches	TOTAL CAPACITY Includes one in the chamber	AVERAGE WEIGHT lbs. / Oz.	OVERALL LENGTH Inches	DROP AT COMB Inches	DROP AT HEEL Inches	LENGTH OF PULL Inches	RATE OF TWIST Inches
		CODE NUMBER	SUGGESTED RETAIL	NEW 2015	CODE NUMBER									
X-BOLT HUNTER														
	• 223 Rem.	035342208	899.99	• 035343208	939.99	SS	22	6	6 / 6	41-1/4	11/16	1/2	13-5/8	8
	• 22-250 Rem.	035342209	899.99	• 035343209	939.99	SS	22	5	6 / 6	41-1/4	11/16	1/2	13-5/8	9
	243 Win.	035208211	899.99	035255211	939.99	S	22	5	6 / 8	41-1/4	11/16	1/2	13-5/8	10
	7mm-08 Rem.	035208216	899.99	035255216	939.99	S	22	5	6 / 8	41-1/4	11/16	1/2	13-5/8	9-1/2
	308 Win.	035208218	899.99	035255218	939.99	S	22	5	6 / 8	41-1/4	11/16	1/2	13-5/8	12
	270 WSM	035208248	949.99	035255248	979.99	S	23	4	6 / 11	42-3/4	11/16	1/2	13-5/8	10
A	300 WSM	035208246	949.99	035255246	979.99	S	23	4	6 / 11	42-3/4	11/16	1/2	13-5/8	10
	325 WSM	035208277	949.99	—	—	S	23	4	6 / 11	42-3/4	11/16	1/2	13-5/8	10
	25-06 Rem.	035208223	899.99	035255223	939.99	L	24	5	6 / 14	42-3/4	11/16	1/2	13-5/8	10
	270 Win.	035208224	899.99	035255224	939.99	L	22	5	6 / 12	42-3/4	11/16	1/2	13-5/8	10
	280 Rem.	035208225	899.99	—	—	L	22	5	6 / 12	42-3/4	11/16	1/2	13-5/8	10
	30-06 Sprg.	035208226	899.99	035255226	939.99	L	22	5	6 / 12	42-3/4	11/16	1/2	13-5/8	10
	7mm Rem. Mag.	035208227	949.99	035255227	979.99	L	26	4	7 / 0	46-3/4	11/16	1/2	13-5/8	9-1/2
	300 Win. Mag.	035208229	949.99	035255229	979.99	L	26	4	7 / 0	46-3/4	11/16	1/2	13-5/8	10
	338 Win. Mag.	035208231	949.99	—	—	L	26	4	7 / 0	46-3/4	11/16	1/2	13-5/8	10
	375 H&H Mag.	035208132	949.99	—	—	L	24	4	7 / 0	46-3/4	11/16	1/2	13-5/8	12
X-BOLT MICRO MIDAS														
	• 22-250 Rem.	035346209	859.99	—	—	SS	20	5	6 / 1	38-3/8	11/16	1/2	12-1/2	9
B	243 Win.	035248211	859.99	• 035279211	939.99	S	20	5	6 / 1	38-7/8	11/16	1/2	12-1/2	10
	7mm-08 Rem.	035248216	859.99	• 035279216	979.99	S	20	5	6 / 1	38-7/8	11/16	1/2	12-1/2	9-1/2
	308 Win.	035248218	859.99	• 035279218	979.99	S	20	5	6 / 1	38-7/8	11/16	1/2	12-1/2	12
	• 270 WSM	035248248	899.99	—	—	S	22	4	6 / 6	40-7/8	11/16	1/2	12-1/2	10
	• 300 WSM	035248246	899.99	—	—	S	22	4	6 / 6	40-7/8	11/16	1/2	12-1/2	10



C X-BOLT COMPOSITE STALKER

NEW CALIBER

NEW TWIST RATES
223 REM. AND 22-250 REM.



D X-BOLT STAINLESS STALKER

NEW CALIBER

NEW TWIST RATES
223 REM. AND 22-250 REM.



E X-BOLT VARMINT STALKER, MOSSY OAK® BRUSH®

NEW

C X-BOLT COMPOSITE STALKER D X-BOLT STAINLESS STALKER

RECEIVER Steel or stainless steel • Matte blued or stainless finish • Glass bedded • Drilled and tapped for scope mounts **BARREL** Matte blued or stainless finish • Free-floating • Hand chambered • Target crown **ACTION** Bolt-action • 60° bolt lift • Adjustable Feather Trigger • Detachable rotary magazine • Top-tang safety • Bolt unlock button **STOCK** Composite • Textured gripping surfaces • Palm swell • Matte black • Dura-Touch Armor Coating **FEATURES** Sling swivel studs • Inflex recoil pad • 375 H&H Mag. includes open sights with 18" sight radius (Scope and mounts not included)

E X-BOLT VARMINT STALKER, MOSSY OAK BRUSH

RECEIVER Steel • Matte blued finish • Glass bedded • Drilled and tapped for scope mounts **BARREL** Heavy sporter contour • Matte blued finish • Free-floating • Hand chambered • Target crown **ACTION** Bolt-action • 60° bolt lift • Adjustable Feather Trigger • Detachable rotary magazine • Top-tang safety • Bolt unlock button **STOCK** Composite • Textured gripping surfaces • Palm swell • Mossy Oak® Brush® camo finish • Dura-Touch Armor Coating **FEATURES** Sling swivel studs • Inflex recoil pad

NEW 2015	CALIBER	X-BOLT COMPOSITE STALKER		NEW 2015	X-BOLT STAINLESS STALKER		ACTION SS / Super Short S / Short, L / Long	BARREL LENGTH Inches	TOTAL CAPACITY Includes one in the chamber	AVERAGE WEIGHT Lbs. / Oz.	OVERALL LENGTH Inches	DROP AT COMB Inches	DROP AT HEEL Inches	LENGTH OF PULL Inches	RATE OF TWIST Inches
		CODE NUMBER	SUGGESTED RETAIL		CODE NUMBER	SUGGESTED RETAIL									
C	• 223 Rem.	035335208	859.99	D	• 035336208	1,139.99	SS	22	6	6 / 5	41-1/2	11/16	1/2	13-5/8	8
	• 22/250 Rem.	035335209	859.99		• 035336209	1,139.99	SS	22	5	6 / 5	41-1/2	11/16	1/2	13-5/8	9
	• 243 Win.	035201211	859.99		• 035202211	1,139.99	S	22	5	6 / 5	42	11/16	1/2	13-5/8	10
	• 6.5 Creedmoor	035201282	859.99		• 035202282	1,139.99	S	22	5	6 / 5	42	11/16	1/2	13-5/8	8
	• 7mm-08 Rem.	035201216	859.99		• 035202216	1,139.99	S	22	5	6 / 5	42	11/16	1/2	13-5/8	9-1/2
	• 308 Win.	035201218	859.99		• 035202218	1,139.99	S	22	5	6 / 5	42	11/16	1/2	13-5/8	12
	• 270 WSM	035201248	899.99		• 035202248	1,179.99	S	23	4	6 / 8	43	11/16	1/2	13-5/8	10
	• 7mm WSM	-	-		• 035202249	1,179.99	S	23	4	6 / 8	43	11/16	1/2	13-5/8	9-1/2
	• 300 WSM	035201246	899.99		• 035202246	1,179.99	S	23	4	6 / 8	43	11/16	1/2	13-5/8	10
	• 325 WSM	-	-		• 035202277	1,179.99	S	23	4	6 / 8	43	11/16	1/2	13-5/8	10
	• 25-06 Rem.	035201223	859.99		• 035202223	1,139.99	L	24	5	6 / 11	44-3/4	11/16	1/2	13-5/8	10
	• 270 Win.	035201224	859.99		• 035202224	1,139.99	L	22	5	6 / 9	42-3/4	11/16	1/2	13-5/8	10
	• 280 Rem.	035201225	859.99		• 035202225	1,139.99	L	22	5	6 / 9	42-3/4	11/16	1/2	13-5/8	10
	• 30-06 Sprg.	035201226	859.99		• 035202226	1,139.99	L	22	5	6 / 9	42-3/4	11/16	1/2	13-5/8	10
	• 7mm Rem. Mag.	035201227	899.99		• 035202227	1,179.99	L	26	4	6 / 13	46-3/4	11/16	1/2	13-5/8	9-1/2
	• 300 Win. Mag.	035201229	899.99		• 035202229	1,179.99	L	26	4	6 / 13	46-3/4	11/16	1/2	13-5/8	10
	• 338 Win. Mag.	035201231	899.99		• 035202231	1,179.99	L	26	4	6 / 13	46-3/4	11/16	1/2	13-5/8	10
	• 375 H&H	-	-		• 035202132	1,179.99	L	24	4	6 / 13	44-3/4	11/16	1/2	13-5/8	12

NEW 2015	CALIBER	CODE NUMBER	SUGGESTED RETAIL	ACTION SS / Super Short S / Short	BARREL LENGTH Inches	TOTAL CAPACITY Includes one in the chamber	AVERAGE WEIGHT Lbs. / Oz.	OVERALL LENGTH Inches	DROP AT COMB Inches	DROP AT HEEL Inches	LENGTH OF PULL Inches	RATE OF TWIST Inches
X-BOLT VARMINT STALKER, MOSSY OAK BRUSH												
•	204 Rgr.	035334274	939.99	SS	24	6	6 / 15	43-1/2	11/16	1/2	13-5/8	12
•	223 Rem.	035334208	939.99	SS	24	6	6 / 15	43-1/2	11/16	1/2	13-5/8	12
•	22-250 Rem.	035334209	939.99	SS	26	5	7 / 2	45-1/2	11/16	1/2	13-5/8	14
•	243 Win.	035334211	939.99	S	24	5	6 / 14	44	11/16	1/2	13-5/8	10
E	• 308 Win.	035334218	939.99	S	24	5	6 / 13	44	11/16	1/2	13-5/8	12



THE AB3 — NOW IN SHORT ACTION CALIBERS.

The Browning AB3 packs a tremendous amount of performance and features into a very affordable package, without sacrificing the quality that we are renowned for. These straight-shooting rifles are now available in short action calibers to meet the demands of even more shooters. The AB3's secret to accuracy is the barrel, made to the same quality standards as other Browning rifles.

**LARGE BOLT SURFACE**

- The robust bolt offers additional rigidity.
- The bolt is machined from solid steel bar stock and machined internally to keep weight low.
- Three locking lugs provide exceptional bolt strength.
- Super smooth chrome bolt finish is great looking, quieter and offers smooth cycling.

**INFLEX RECOIL PAD**

- Inflex recoil pad softens recoil and allows faster, more accurate second shots.
- Internal structure is designed to pull the rifle down and away from the face to reduce felt recoil.

**BOLT LOCK OVERRIDE BUTTON**

- The bolt lock override button provides an additional margin of safety when checking and unloading the chamber.
- Located behind the bolt handle, the bolt lock override allows the bolt to be unlocked and opened with the tang safety in the on safe position.
- The convenient tang safety blocks the trigger sear and sear.

**DETACHABLE MAGAZINE**

- Polymer and steel construction is lightweight and extra tough.
- Unique spring and follower design minimizes follower tilt for more reliable feeding.

**FREE-FLOATING BARREL**

- The free-floating maintains barrel to stock spacing for consistent accuracy.
- Recessed muzzle crown helps protect the rifling from damage.
- Precision button-rifled barrel is triple checked for interior finish, straightness and air-gauged for uniformity.
- Hand-reamed chamber for precision accuracy.

**60° BOLT LIFT**

- Short 60° bolt lift is fast cycling and the hand easily clears the scope.

ALL BROWNING FIREARMS ARE SHIPPED WITH A FREE LOCKING DEVICE TO ASSIST IN THE SAFE STORAGE OF FIREARMS.

IT LOOKS GOOD TOO.

The Browning AB3 is a super value with a top-quality barrel, Inflex recoil pad and smooth-riding chromed bolt, but great lengths were taken to ensure the AB3 looks as good as it shoots. The composite stock features a tight radius grip for optimum finger-to-trigger reach and a narrow fore-end with textured gripping surfaces for enhanced control. The crisp trigger breaks between 3-1/2 to 4-1/2 ounces. Pick up an AB3; it might be difficult to put back down.



A AB3 COMPOSITE STALKER

NEW CALIBERS

RECEIVER Steel • Matte blued finish • Drilled and tapped for scope mounts **BARREL** Matte blued finish • Free-floating • Hand chambered • Target crown **ACTION** Bolt-action • 60° bolt lift • Detachable box magazine • Top-tang safety • Bolt lock override button **STOCK** Composite • Textured gripping surfaces **FEATURES** Sling swivel studs installed • Inflex recoil pad (Scope and mounts not included)

NEW 2015	CALIBER	CODE NUMBER	SUGGESTED RETAIL	ACTION S / Short L / Long	BARREL LENGTH Inches	TOTAL CAPACITY Includes one in the chamber	AVERAGE WEIGHT Lbs. / Oz.	OVERALL LENGTH Inches	DROP AT COMB Inches	DROP AT HEEL Inches	LENGTH OF PULL Inches	RATE OF TWIST Inches
AB3 COMPOSITE STALKER												
•	243 Win.	035800211	599.99	S	22	6	6 / 11	42	11/16	1/2	13-5/8	10
•	7mm-08 Rem.	035800216	599.99	S	22	6	6 / 10	42	11/16	1/2	13-5/8	9-1/2
•	308 Win.	035800218	599.99	S	22	6	6 / 9	43	11/16	1/2	13-5/8	12
•	270 WSM	035800248	599.99	S	23	4	6 / 11	43	11/16	1/2	13-5/8	10
•	300 WSM	035800246	599.99	S	23	4	6 / 12	43	11/16	1/2	13-5/8	10
A	270 Win.	035800224	599.99	L	22	5	6 / 13	42-3/4	11/16	1/2	13-5/8	10
	30/06 Sprg.	035800226	599.99	L	22	5	6 / 13	42-3/4	11/16	1/2	13-5/8	10
	7mm Rem. Mag	035800227	599.99	L	26	4	7 / 3	46-3/4	11/16	1/2	13-5/8	9-1/2
	300 Win. Mag.	035800229	599.99	L	26	4	7 / 3	46-3/4	11/16	1/2	13-5/8	10



SADDLE UP.

Compact, easy to handle and fast to cycle, the Browning BLR makes a winning argument against those that claim lever-action rifle technology peaked in the late 1800s. With a detachable box magazine that allows the use of superior pointed bullets, a strong multi-lug bolt, glass-smooth lever-action and accuracy that rivals some bolt-action rifles, the BLR proves that lever-actions are not out to pasture.



RECEIVER

- Lightweight, sturdy machined aircraft-grade aluminum. Drilled and tapped to accept scope mounts.



ACTION

- Lightning fast, glass-smooth rack and pinion lever-action.
- Strong rotating head, multiple-lug breech bolt with a recessed bolt face and side ejection.



HAMMER

- The folding hammer provides an added measure of safety when the hammer is at half-cock.
- The fold-down hammer has two positions at half-cock so the status of the rifle is readily seen; and four basic positions: Full-cock, half-cock, folded hammer position and the dropped, or fired position.



TAKEDOWN FEATURES

- BLR Takedown models are just as accurate and reliable as their unified counterparts but much easier to transport and store.
- The rifle is easily and quickly assembled by simply sliding the barrel half into the receiver half and locking them together with the flip of a lever. The lever mechanically engages a stout locking lug into a recess in the bottom of the receiver. The system is rugged, precise and blends seamlessly into the styling of the rifle.

ALL BROWNING FIREARMS ARE SHIPPED WITH A FREE LOCKING DEVICE TO ASSIST IN THE SAFE STORAGE OF FIREARMS.



A BLR LIGHTWEIGHT '81 STAINLESS TAKEDOWN



RECEIVER Aircraft-grade alloy • Satin nickel finish • Drilled and tapped for scope mounts **BARREL** Matte stainless steel finish • Crowned muzzle • Adjustable sights • Drilled and tapped for scout scope mount (not included) **ACTION** Lever-action • Rotating bolt • Detachable box magazine **STOCK** Satin finish gray laminate wood • Checkered straight grip **FEATURES** Recoil pad • Separates for storage or transportation • Optional scout-style scope mount • TRUGLO®/Marble Arms® fiber-optic front sight

NEW 2015	CALIBER	CODE NUMBER	SUGGESTED RETAIL	ACTION S/ Short L/ Long	BARREL LENGTH Inches	TOTAL CAPACITY Includes one in the chamber	AVERAGE WEIGHT Lbs./ Oz.	OVERALL LENGTH Inches	SIGHT RADIUS Inches	DROP AT COMB Inches	DROP AT HEEL Inches	LENGTH OF PULL Inches	RATE OF TWIST Inches
BLR LIGHTWEIGHT '81 STAINLESS TAKEDOWN													
	223 Rem.	034015108	1,229.99	S	20	5	6 / 8	40	17-3/4	7/8	15/16	13-3/4	12
	22-250 Rem.	034015109	1,229.99	S	20	5	6 / 8	40	17-3/4	7/8	15/16	13-3/4	14
	243 Win.	034015111	1,229.99	S	20	5	6 / 8	40	17-3/4	7/8	15/16	13-3/4	10
	7mm-08 Rem.	034015116	1,229.99	S	20	5	6 / 8	40	17-3/4	7/8	15/16	13-3/4	9-1/2
A	308 Win.	034015118	1,229.99	S	20	5	6 / 8	40	17-3/4	7/8	15/16	13-3/4	12
	358 Win.	034015120	1,229.99	S	20	5	6 / 8	40	17-3/4	7/8	15/16	13-3/4	12
	450 Marlin	034015150	1,229.99	S	20	4	7 / 0	40	17-3/4	7/8	15/16	13-3/4	20
	270 WSM	034015148	1,299.99	S	22	4	6 / 12	42	19-3/4	7/8	15/16	13-3/4	10
	300 WSM	034015146	1,299.99	S	22	4	6 / 12	42	19-3/4	7/8	15/16	13-3/4	10
	270 Win.	034015124	1,279.99	L	22	5	7 / 4	43	19-3/4	1	1-3/8	14-1/4	10
	30-06 Sprg.	034015126	1,279.99	L	22	5	7 / 4	43	19-3/4	1	1-3/8	14-1/4	10
	7mm Rem. Mag.	034015127	1,279.99	L	24	4	7 / 12	45	20	1	1-3/8	14-1/4	9-1/2
	300 Win. Mag.	034015129	1,279.99	L	24	4	7 / 12	45	20	1	1-3/8	14-1/4	10



B BLR LIGHTWEIGHT '81



C BLR LIGHTWEIGHT STAINLESS WITH PISTOL GRIP



D BLR LIGHTWEIGHT WITH PISTOL GRIP



B BLR LIGHTWEIGHT '81

RECEIVER Aircraft-grade alloy • Blued finish • Drilled and tapped for scope mounts **BARREL** Blued finish • Crowned muzzle • Adjustable sights **ACTION** Lever-action • Rotating bolt • Detachable box magazine **STOCK** Gloss finish walnut • Checkered • Straight grip **FEATURES** Recoil pad

C BLR LIGHTWEIGHT STAINLESS WITH PISTOL GRIP

D BLR LIGHTWEIGHT WITH PISTOL GRIP

RECEIVER Aircraft-grade alloy • Satin nickel finish or polished blued finish • Drilled and tapped for scope mounts **BARREL** Matte stainless steel or polished blued finish • Crowned muzzle • Adjustable sights **ACTION** Lever-action • Rotating bolt • Detachable box magazine **STOCK** Gloss finish walnut • Checkered pistol grip with Schnabel forearm **FEATURES** Sling swivel studs • Recoil pad

NEW 2015	CALIBER	CODE NUMBER	SUGGESTED RETAIL	ACTION S / Short L / Long	BARREL LENGTH Inches	TOTAL CAPACITY Includes one in the chamber	AVERAGE WEIGHT Lbs. / Oz.	OVERALL LENGTH Inches	SIGHT RADIUS Inches	DROP AT COMB Inches	DROP AT HEEL Inches	LENGTH OF PULL Inches	RATE OF TWIST Inches
BLR LIGHTWEIGHT '81													
	223 Rem.	034006108	959.99	S	20	5	6 / 8	40	17-3/4	7/8	15/16	13-3/4	12
	22-250 Rem.	034006109	959.99	S	20	5	6 / 8	40	17-3/4	7/8	15/16	13-3/4	14
	243 Win.	034006111	959.99	S	20	5	6 / 8	40	17-3/4	7/8	15/16	13-3/4	10
	7mm-08 Rem.	034006116	959.99	S	20	5	6 / 8	40	17-3/4	7/8	15/16	13-3/4	9-1/2
	308 Win.	034006118	959.99	S	20	5	6 / 8	40	17-3/4	7/8	15/16	13-3/4	12
	358 Win.	034006120	959.99	S	20	5	6 / 8	40	17-3/4	7/8	15/16	13-3/4	12
B	270 WSM	034006148	1,039.99	S	22	4	6 / 12	42	19-3/4	7/8	15/16	13-3/4	10
	300 WSM	034006146	1,039.99	S	22	4	6 / 12	42	19-3/4	7/8	15/16	13-3/4	10
	270 Win.	034006124	1,019.99	L	22	5	7 / 4	43	19-3/4	1	1-3/8	14-1/4	10
	30-06 Sprg.	034006126	1,019.99	L	22	5	7 / 4	43	19-3/4	1	1-3/8	14-1/4	10
	7mm Rem. Mag.	034006127	1,019.99	L	24	4	7 / 12	45	20	1	1-3/8	14-1/4	9-1/2
	300 Win. Mag.	034006129	1,019.99	L	24	4	7 / 12	45	20	1	1-3/8	14-1/4	10
BLR LIGHTWEIGHT STAINLESS WITH PISTOL GRIP													
	223 Rem.	034018108	1,099.99	S	20	5	6 / 8	40	17-3/4	1	15/16	13-3/4	12
	22-250 Rem.	034018109	1,099.99	S	20	5	6 / 8	40	17-3/4	1	15/16	13-3/4	14
	243 Win.	034018111	1,099.99	S	20	5	6 / 8	40	17-3/4	1	15/16	13-3/4	10
	7mm-08 Rem.	034018116	1,099.99	S	20	5	6 / 8	40	17-3/4	1	15/16	13-3/4	9-1/2
	308 Win.	034018118	1,099.99	S	20	5	6 / 8	40	17-3/4	1	15/16	13-3/4	12
	358 Win.	034018120	1,099.99	S	20	5	6 / 8	40	17-3/4	1	15/16	13-3/4	12
	450 Marlin	034018150	1,099.99	S	20	4	7 / 0	40	17-3/4	1	15/16	13-3/4	20
C	270 WSM	034018148	1,179.99	S	22	4	6 / 12	42	19-3/4	1	15/16	13-3/4	10
	300 WSM	034018146	1,179.99	S	22	4	6 / 12	42	19-3/4	1	15/16	13-3/4	10
	270 Win.	034018124	1,149.99	L	22	5	7 / 4	43	19-3/4	7/8	15/16	14-1/4	10
	30-06 Sprg.	034018126	1,149.99	L	22	5	7 / 4	43	19-3/4	7/8	15/16	14-1/4	10
	7mm Rem. Mag.	034018127	1,149.99	L	24	4	7 / 12	45	20	7/8	15/16	14-1/4	9-1/2
	300 Win. Mag.	034018129	1,149.99	L	24	4	7 / 12	45	20	7/8	15/16	14-1/4	10
BLR LIGHTWEIGHT WITH PISTOL GRIP													
	223 Rem.	034009108	1,019.99	S	20	5	6 / 8	40	17-3/4	7/8	15/16	13-3/4	12
	22-250 Rem.	034009109	1,019.99	S	20	5	6 / 8	40	17-3/4	7/8	15/16	13-3/4	14
	243 Win.	034009111	1,019.99	S	20	5	6 / 8	40	17-3/4	7/8	15/16	13-3/4	10
	7mm-08 Rem.	034009116	1,019.99	S	20	5	6 / 8	40	17-3/4	7/8	15/16	13-3/4	9-1/2
D	308 Win.	034009118	1,019.99	S	20	5	6 / 8	40	17-3/4	7/8	15/16	13-3/4	12
	358 Win.	034009120	1,019.99	S	20	5	6 / 8	40	17-3/4	7/8	15/16	13-3/4	12
	450 Marlin	034009150	1,019.99	S	20	4	7 / 0	40	17-3/4	7/8	15/16	13-3/4	20
	270 WSM	034009148	1,099.99	S	22	4	6 / 12	42	17-3/4	7/8	15/16	13-3/4	10
	300 WSM	034009146	1,099.99	S	22	4	6 / 12	42	19-3/4	7/8	15/16	13-3/4	10
	270 Win.	034009124	1,069.99	L	22	5	7 / 4	43	19-3/4	1	1	14-1/4	10
	30-06 Sprg.	034009126	1,069.99	L	22	5	7 / 4	43	19-3/4	1	1	14-1/4	10
	7mm Rem. Mag.	034009127	1,069.99	L	24	4	7 / 12	45	20	1	1	14-1/4	9-1/2
	300 Win. Mag.	034009129	1,069.99	L	24	4	7 / 12	45	20	1	1	14-1/4	10

MAGNUM KNOCK DOWN POWER.

The Browning BAR is the sporting rifle inspired by the original Browning Automatic Rifle. The BAR combines the strength to fire hard-hitting magnum cartridges with the down range accuracy potential to keep rounds right on target. The piston-operated gas system is reliable and softens felt recoil to reduce muzzle climb.



ACTION

- The BAR is a gas-operated autoloader with a high-strength, multiple-lug rotating bolt that locks directly into the barrel.
- The seven-lug bolt and precise breech-to-chamber relationship give the BAR exceptional accuracy and the strength to handle magnum loads.
- The strong and rigid action bar/inertia block link-up improves accuracy by reducing barrel vibration.
- The buffering system reduces wear and stress on the rifle's mechanism.

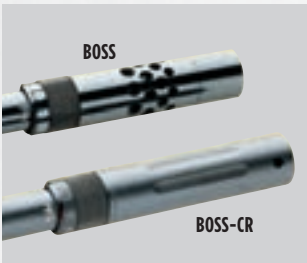

THE BOSS DEVICE

- The Ballistic Optimizing Shooting System (BOSS) is designed to maximize accuracy.
- The BOSS device quickly and easily tunes barrel harmonics to precisely match the specific ammunition fired, resulting in amazingly tight groups. The BOSS device is available as an option on the BAR Mark II Safari.



MAGAZINE

- Detachable box magazine with a unique hinged floorplate allows the shooter to lower the floorplate, detach the empty magazine and snap in a full magazine in mere seconds.



RECEIVER

- The BAR Mark II Safari uses a blued one-piece ordnance steel receiver with scroll engraving.
- ShortTrac and LongTrac models have an aircraft-grade aluminum alloy receiver.
- All BAR rifles are drilled and tapped for scope mounts. The bolt release lever is incorporated into the receiver.



MAXIMUM GRIP

- Camo composite BAR models combine overmolded gripping surfaces and Dura-Touch Armor Coating for a sure hold and a sleek feel in all climate conditions.



ADJUSTABLE SHIM SYSTEM

- ShortTrac and LongTrac BAR rifles include six shims that customize drop at comb and cast on/off.

ALL BROWNING FIREARMS ARE SHIPPED WITH A FREE LOCKING DEVICE TO ASSIST IN THE SAFE STORAGE OF FIREARMS.



RECOIL PADS FOR BAR SHORTTRAC AND LONGTRAC

For wood and composite models **PAD** Black, polymer cushion **TOP** Insert hard polypropylene **REINFORCEMENT** Black, glass-fiber reinforced synthetic **THICKNESS** Choice of 1/2", 3/4" or 1"

	DESCRIPTION	SUGGESTED RETAIL
A	1/2"	44.00
B	3/4"	44.00
C	1"	44.00

AUTOLOADERS WITH STYLE.

Far from the only choice among autoloading rifles, the Browning BAR has what modern sporting rifles don't, the beauty of Browning. In stark contrast to most autoloading rifles, the BAR offers a traditional approach with finely finished walnut contrasting beautifully with satin nickel and polished blue finishes.



D BAR SHORTTRAC



E BAR LONGTRAC

RECEIVER Aircraft-grade alloy • Satin nickel finish • High-relief engraving • Drilled and tapped for scope mounts **BARREL** Blued finish • Hammer-forged **ACTION** Gas-operated autoloader • Multi-lug rotary bolt • Detachable box magazine • Composite trigger guard and floorplate • Crossbolt safety **STOCK** Oil finish Grade II walnut • Stylized forearm • Checkered • Shim adjustable for cast on/off and drop at comb **FEATURES** Sling swivel studs installed • Interchangeable recoil pad (See page 50 for additional pads)

NEW 2015	CALIBER	CODE NUMBER	SUGGESTED RETAIL	ACTION S / Short L / Long	BARREL LENGTH Inches	TOTAL CAPACITY Includes one in the chamber	AVERAGE WEIGHT lbs. / Oz.	OVERALL LENGTH Inches	DROP AT COMB Inches	DROP AT HEEL Inches	LENGTH OF PULL Inches	RATE OF TWIST Inches
BAR SHORTTRAC												
	243 Win.	031534211	1,229.99	S	22	5	6 / 10	42-3/4	5/8	1-1/8	13-1/4	10
	7mm-08 Rem.	031534216	1,229.99	S	22	5	6 / 10	42-3/4	5/8	1-1/8	13-1/4	9-1/2
	308 Win.	031534218	1,229.99	S	22	5	6 / 10	42-3/4	5/8	1-1/8	13-1/4	12
	270 WSM	031534248	1,339.99	S	23	4	7 / 4	43-3/4	5/8	1-1/8	13-1/4	10
D	300 WSM	031534246	1,339.99	S	23	4	7 / 4	43-3/4	5/8	1-1/8	13-1/4	10
BAR LONGTRAC												
	270 Win.	031536224	1,229.99	L	22	5	6 / 15	43	5/8	1-1/8	13-5/8	10
E	30-06 Sprg.	031536226	1,229.99	L	22	5	6 / 15	43	5/8	1-1/8	13-5/8	10
	7mm Rem. Mag.	031536227	1,339.99	L	24	4	7 / 8	45	5/8	1-1/8	13-5/8	9-1/2
	300 Win. Mag.	031536229	1,339.99	L	24	4	7 / 8	45	5/8	1-1/8	13-5/8	10
BAR LONGTRAC, LEFT-HAND (NOT SHOWN)												
	270 Win.	031537224	1,269.99	L	22	5	6 / 15	43	5/8	1-1/8	13-5/8	10
	30-06 Sprg.	031537226	1,269.99	L	22	5	6 / 15	43	5/8	1-1/8	13-5/8	10
	300 Win. Mag.	031537229	1,359.99	L	24	4	7 / 8	45	5/8	1-1/8	13-5/8	10



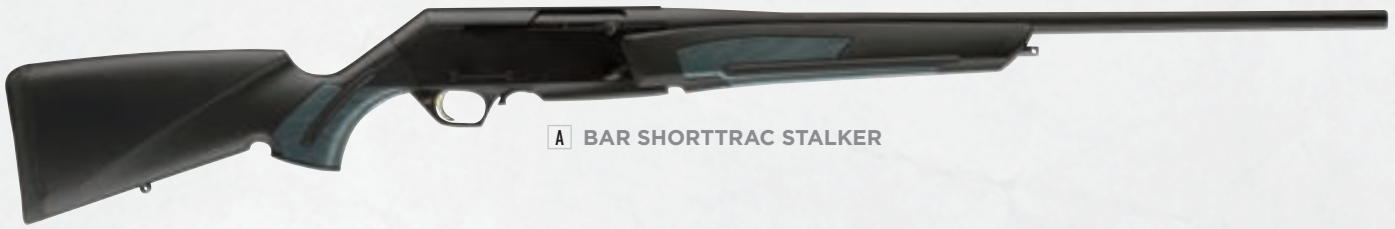

A BAR SHORTTRAC STALKER

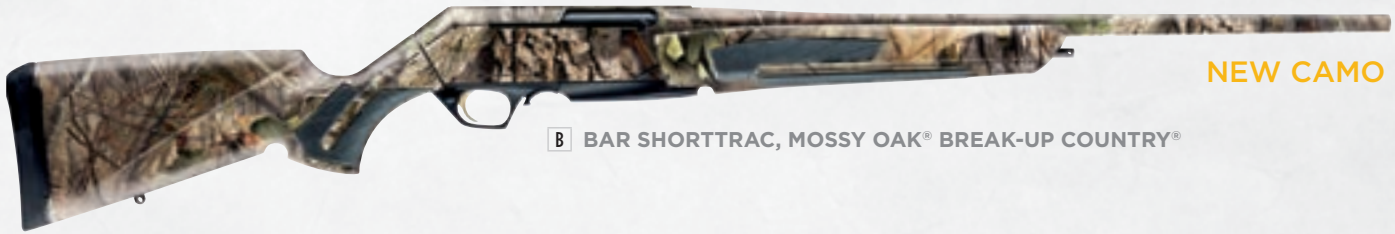

B BAR SHORTTRAC, MOSSY OAK® BREAK-UP COUNTRY®

NEW CAMO



C BAR LONGTRAC STALKER

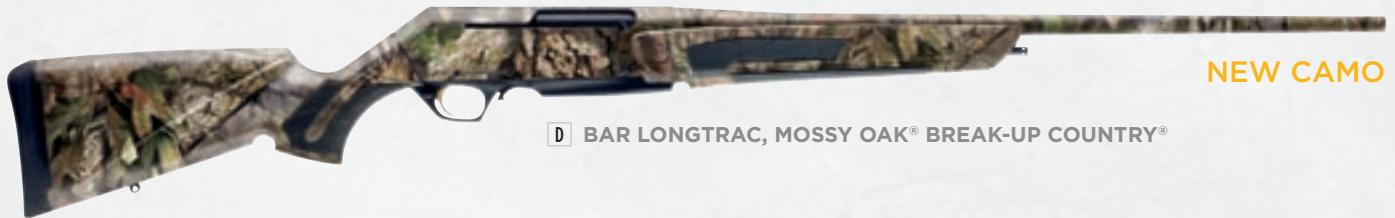

D BAR LONGTRAC, MOSSY OAK® BREAK-UP COUNTRY®

NEW CAMO

RECEIVER Aircraft-grade alloy • Drilled and tapped for scope mounts **BARREL** Hammer-forged **ACTION** Gas-operated autoloader • Multi-lug rotary bolt • Detachable box magazine • Composite trigger guard and floorplate • Crossbolt safety **STOCK** Composite • Matte black or Mossy Oak® Break-Up Country® camo finish • Overmolded gripping panels • Shim adjustable for cast on/off and drop at comb

FEATURES Sling swivel studs installed • Interchangeable recoil pad (See page 50 for additional pads)

NEW 2015	CALIBER	CODE NUMBER	SUGGESTED RETAIL	ACTION S/Short L/Long	BARREL LENGTH Inches	TOTAL CAPACITY Includes one in the chamber	AVERAGE WEIGHT Lbs. / Oz.	OVERALL LENGTH Inches	DROP AT COMB Inches	DROP AT HEEL Inches	LENGTH OF PULL Inches	RATE OF TWIST Inches
BAR SHORTTRAC STALKER												
	243 Win.	031330211	1,259.99	S	22	5	6 / 10	41-1/2	5/8	1-1/8	13-5/8	10
	7mm-08 Rem.	031330216	1,259.99	S	22	5	6 / 10	41-1/2	5/8	1-1/8	13-5/8	9-1/2
	308 Win.	031330218	1,259.99	S	22	5	6 / 10	41-1/2	5/8	1-1/8	13-5/8	12
	270 WSM	031330248	1,349.99	S	23	4	7 / 4	42-1/2	5/8	1-1/8	13-5/8	10
A	300 WSM	031330246	1,349.99	S	23	4	7 / 4	42-1/2	5/8	1-1/8	13-5/8	10
BAR SHORTTRAC, MOSSY OAK BREAK-UP COUNTRY												
	• 243 Win.	031042211	1,359.99	S	22	5	6 / 10	41-1/2	5/8	1-1/8	13-5/8	10
	• 7mm-08 Rem.	031042216	1,359.99	S	22	5	6 / 10	41-1/2	5/8	1-1/8	13-5/8	9-1/2
B	• 308 Win.	031042218	1,359.99	S	22	5	6 / 10	41-1/2	5/8	1-1/8	13-5/8	12
	• 270 WSM	031042248	1,479.99	S	23	4	7 / 4	42-1/2	5/8	1-1/8	13-5/8	10
	• 300 WSM	031042246	1,479.99	S	23	4	7 / 4	42-1/2	5/8	1-1/8	13-5/8	10
BAR LONGTRAC STALKER												
	270 Win.	031331224	1,259.99	L	22	5	6 / 15	42	5/8	1-1/8	13-5/8	10
C	30-06 Sprg.	031331226	1,259.99	L	22	5	6 / 15	42	5/8	1-1/8	13-5/8	10
	7mm Rem. Mag.	031331227	1,349.99	L	24	4	7 / 8	44	5/8	1-1/8	13-5/8	9-1/2
	300 Win. Mag.	031331229	1,349.99	L	24	4	7 / 8	44	5/8	1-1/8	13-5/8	10
BAR LONGTRAC, MOSSY OAK BREAK-UP COUNTRY												
	• 270 Win.	031043224	1,359.99	L	22	5	6 / 15	42	5/8	1-1/8	13-5/8	10
	• 30-06 Sprg.	031043226	1,359.99	L	22	5	6 / 15	42	5/8	1-1/8	13-5/8	10
	• 7mm Rem. Mag.	031043227	1,479.99	L	24	4	7 / 8	44	5/8	1-1/8	13-5/8	9-1/2
D	• 300 Win. Mag.	031043229	1,479.99	L	24	4	7 / 8	44	5/8	1-1/8	13-5/8	10





E BAR MARK II SAFARI

RECEIVER Steel • Blued finish • Scroll engraving • Drilled and tapped for scope mounts **BARREL** Blued finish • Hammer-forged **ACTION** Gas-operated autoloader • Multi-lug rotary bolt • Detachable box magazine • Crossbolt safety **STOCK** Select gloss finish walnut • Rounded forearm • Checkered **FEATURES** Sling swivel studs installed • Recoil pad • Available with BOSS device, BOSS-CR device optional (Scope and mounts not included)

NEW 2015	CALIBER	CODE NUMBER	SUGGESTED RETAIL	BARREL LENGTH Inches	TOTAL CAPACITY Includes one in the chamber	AVERAGE WEIGHT Lbs. / Oz.	OVERALL LENGTH Inches	DROP AT COMB Inches	DROP AT HEEL Inches	LENGTH OF PULL Inches	RATE OF TWIST Inches
BAR MARK II SAFARI (NOT SHOWN)											
	308 Win.	031001218	1,229.99	22	5	7 / 8	43	3/4	1-1/8	13-3/4	12
	25-06 Rem.	031001223	1,229.99	24	5	7 / 10	45	3/4	1-1/8	13-3/4	10
	270 Win.	031001224	1,229.99	22	5	7 / 8	43	3/4	1-1/8	13-3/4	10
	30-06 Sprg.	031001226	1,229.99	22	5	7 / 8	43	3/4	1-1/8	13-3/4	10
	300 Win. Mag.	031001229	1,349.99	24	4	8 / 10	45	3/4	1-1/8	13-3/4	10
BAR MARK II SAFARI WITH BOSS											
	270 Win.	031001324	1,389.99	22	5	7 / 6	43	3/4	1-1/8	13-3/4	10
E	30-06 Sprg.	031001326	1,389.99	22	5	7 / 6	43	3/4	1-1/8	13-3/4	10
	300 Win. Mag.	031001329	1,499.99	24	4	8 / 6	45	3/4	1-1/8	13-3/4	10
	338 Win. Mag.	031001331	1,499.99	24	4	8 / 6	45	3/4	1-1/8	13-3/4	10

BOSS-CR ACCESSORY

The BOSS-CR accessory offers all the accuracy and tunable advantages of the original BOSS device without the muzzle brake feature. By simply replacing the original BOSS forward weight and recoil reduction components with the one-piece, non-ported BOSS-CR accessory, only the reduced recoil of the original BOSS is sacrificed. The BOSS-CR accessory is designed to fit only BAR Mark II and A-Bolt centerfire rifles previously factory-fitted with the BOSS. **GLOSS BLUED** for BAR Safari; A-Bolt models: Medallion and Gold Medallion **MATTE BLUED** for A-Bolt models: Composite Stalker, Hunter, Euro-Bolt, Varmint, Eclipse Hunter and M-1000 Eclipse **STAINLESS** for A-Bolt models: Stainless Stalker, White Gold, Medallion and M-1000 Eclipse **IT IS IMPORTANT THAT THE CORRECT BOSS-CR BE SELECTED FOR A SPECIFIC CALIBER AND MODEL OF RIFLE.**

DESCRIPTION	SUGGESTED RETAIL
Gloss Blued	39.99
Matte Blued	39.99
Stainless	39.99



CALIBER	GLOSS BLUED	MATTE BLUED	STAINLESS
	CODE NUMBER	CODE NUMBER	CODE NUMBER
223 Rem.	1140011	1140012	1140013
223 Varmint	1140061	1140062	—
223 WSSM	1140011	1140012	1140013
243 WSSM	1140011	1140012	1140013
25 WSSM	1140011	1140012	1140013
22-250 Rem.	1140011	1140012	1140013
22-250 Varmint	1140061	1140062	—
22-250 Varmint (M-1000)	—	1140062	1140063
243 Win.	1140011	1140012	1140013
7mm-08 Rem.	1140011	1140012	1140013
308 Win.	1140021	1140022	1140023
308 Varmint	1140061	1140062	—
308 Varmint (M-1000)	—	1140062	1140063
25-06 Rem.	1140011	1140012	1140013
260 Rem.	1140011	1140012	1140013
270 WSM	1140021	1140022	1140023
270 Win.	1140011	1140012	1140013
280 Rem.	1140011	1140012	1140013
30-06 Sprg.	1140031	1140032	1140033
7mm WSM	1140021	1140022	1140023
7mm Rem. Mag.	1140021	1140022	1140023
300 WSM	1140041	1140042	1140043
300 WSM (M-1000)	—	1140092	1140093
300 Win. Mag.	1140041	1140042	1140043
300 Win. Mag. (M-1000)	—	1140092	—
325 WSM	1140051	1140052	1140053
338 Win. Mag.	1140051	1140052	1140053
375 H&H Mag.	1140071	—	1140073

STRAIGHT UP PERFORMANCE.

The straight-pull bolt action of the Browning T-Bolt really makes it stand out in a crowd. This neat design cycles fast and locks up tight for excellent accuracy. Tremendously fun to shoot, T-Bolt rifles are made to the highest standards of quality.



STOCK

- Stocks are full-size to more comfortably fit adults.
- Durable Composite models feature a Monte Carlo comb and include magazine storage in the buttstock.
- Walnut stocked Sporter models feature trim dimensions with a satin finish and cut checkering. Walnut Target/Varmint models feature a Monte Carlo comb and wide forearm for stability on the bench.
- All models include a bedded action and dual action screws for solid attachment.
- Sling swivel studs included.



TRIGGER

- The three-lever trigger design combined with a short-travel firing pin give a crisp break, quick lock time, no take-up and minimal overtravel.
- Adjustable for pull weight.



BUTTSTOCK MAGAZINE STORAGE

- Composite stock models offer a convenient location to securely store an extra magazine.



ACTION

- Receiver is machined from steel barstock.
- Features crossbolt lockup for strength and smooth operation.
- The mainspring runs directly through the massive pivot pin. Cocking effort is split between opening and closing for ease of operation. The bolt features dual extractors and a red cocking indicator band.
- Right-side ejection on both right- and left-hand models.



SAFETY

- Top-tang, thumb operated two-position safety can be operated without changing from a shooting grip.

BARREL

- Target/Varmint models feature a 22" medium target profile.
- T-Bolt Sporter models feature a 22" medium sporter profile.
- Barrel is free-floating with a semi-match chamber and target muzzle crown.

OPTICS READY

- Receiver is drilled and tapped for scope mounts (not included). See pages 136-137 for scope rings and bases for T-Bolt rifles.

ALL BROWNING FIREARMS ARE SHIPPED WITH A FREE LOCKING DEVICE TO ASSIST IN THE SAFE STORAGE OF FIREARMS.



22 Long Rifle

17 HMR / 22 WMR

DOUBLE HELIX MAGAZINES

- 10-round capacity.
- The patented Double Helix rotary box magazine uses torsion spring driven interlocking gears for added reliability and easy loading and unloading.





A T-BOLT COMPOSITE SPORTER



B T-BOLT COMPOSITE TARGET/VARMINT



C T-BOLT SPORTER



D T-BOLT TARGET/VARMINT

A T-BOLT COMPOSITE SPORTER

B T-BOLT COMPOSITE TARGET/VARMINT

RECEIVER Steel • Blued finish • Drilled and tapped for scope mounts **BARREL** Sporter or medium varmint • Blued finish • Free-floating • Semi-match chamber • Recessed crown **ACTION** Straight pull bolt-action • Top-tang safety • Adjustable trigger **STOCK** Composite • Textured gripping surfaces • Matte black • Spare magazine storage compartment **FEATURES** Spare magazine included • Sling swivel studs installed (Scope and mounts not included)

C T-BOLT SPORTER • T-BOLT SPORTER, LEFT-HAND

D T-BOLT TARGET/VARMINT • T-BOLT TARGET/VARMINT, LEFT-HAND

RECEIVER Steel • Blued finish • Drilled and tapped for scope mounts **BARREL** Sporter or medium varmint • Blued finish • Free-floating • Semi-match chamber • Recessed crown **ACTION** Straight pull bolt-action • Top-tang safety • Adjustable trigger • Right- and left-hand models have right side ejection **STOCK** Satin finish walnut • Checkered **FEATURES** Sling swivel studs installed

NEW 2015	CALLIBER	CODE NUMBER	SUGGESTED RETAIL	BARREL LENGTH Inches	TOTAL CAPACITY Includes one in the chamber	AVERAGE WEIGHT Lbs. / Oz.	OVERALL LENGTH Inches	DROP AT COMB Inches	DROP AT HEEL Inches	LENGTH OF PULL Inches	RATE OF TWIST Inches
T-BOLT COMPOSITE SPORTER											
A	22 LR	025179202	749.99	22	11	4 / 9	40-1/4	5/8	5/8	13-1/2	16
	22 WMR	025179204	779.99	22	11	4 / 9	40-1/4	5/8	5/8	13-1/2	16
	17 HMR	025179270	779.99	22	11	4 / 9	40-1/4	5/8	5/8	13-1/2	9
T-BOLT COMPOSITE TARGET/VARMINT											
B	22 LR	025180202	779.99	22	11	5 / 2	40-1/4	5/8	5/8	13-1/2	16
	22 WMR	025180204	799.99	22	11	5 / 2	40-1/4	5/8	5/8	13-1/2	16
	17 HMR	025180270	799.99	22	11	5 / 2	40-1/4	5/8	5/8	13-1/2	9
T-BOLT SPORTER											
C	22 LR	025175202	749.99	22	11	4 / 14	40-1/4	5/8	5/8	13-1/2	16
	22 WMR	025175204	779.99	22	11	4 / 14	40-1/4	5/8	5/8	13-1/2	16
	17 HMR	025175270	779.99	22	11	4 / 14	40-1/4	5/8	5/8	13-1/2	9
T-BOLT SPORTER, LEFT-HAND (NOT SHOWN)											
	22 LR	025184202	749.99	22	11	4 / 14	40-1/4	5/8	5/8	13-1/2	16
	22 WMR	025184204	799.99	22	11	4 / 14	40-1/4	5/8	5/8	13-1/2	16
	17 HMR	025184270	799.99	22	11	4 / 14	40-1/4	5/8	5/8	13-1/2	9
T-BOLT TARGET/VARMINT											
D	22 LR	025176202	779.99	22	11	5 / 8	40-1/4	5/8	5/8	13-1/2	16
	22 WMR	025176204	799.99	22	11	5 / 8	40-1/4	5/8	5/8	13-1/2	16
	17 HMR	025176270	799.99	22	11	5 / 8	40-1/4	5/8	5/8	13-1/2	9
T-BOLT TARGET/VARMINT, LEFT-HAND (NOT SHOWN)											
	22 LR	025185202	799.99	22	11	5 / 8	40-1/4	5/8	5/8	13-1/2	16
	22 WMR	025185204	829.99	22	11	5 / 8	40-1/4	5/8	5/8	13-1/2	16
	17 HMR	025185270	829.99	22	11	5 / 8	40-1/4	5/8	5/8	13-1/2	9

A LEVER TO LOVE.

Traditional good looks, rock-solid build quality and quick-throw lever action make the Browning BL-22 a perfect rifle for shooters interested in a reliable rimfire. Long lasting Browning quality ensures the BL-22 will be around for years to come.



RIMFIRE THOROUGHBREDS.

- The slick, lever-action BL-22 is perfect for new and seasoned shooters alike.
- Quick-cycling 33° lever throw.
- The trigger travels with the lever to prevent finger pinch.
- High-quality construction.
- Fires .22 Short, Long and Long Rifle ammunition.
- Short lever throw is ideal for smaller hands.

ALL BROWNING FIREARMS ARE SHIPPED WITH A FREE LOCKING DEVICE TO ASSIST IN THE SAFE STORAGE OF FIREARMS.



A BL-22 GRADE I MICRO MIDAS



B BL-22 GRADE I



C BL-22 GRADE II

A BL-22 GRADE I MICRO MIDAS

RECEIVER Steel • Blued finish • Grooved for scope mounts **BARREL** Blued finish • Recessed crown **ACTION** Lever-action • Short 33° lever throw • Tubular magazine **STOCK** Gloss finish walnut • Straight grip • Compact 12" length of pull for smaller shooters **FEATURES** Adjustable sights with front bead **ELIGIBLE FOR GROWTH INSURANCE PROGRAM** See page 2 for details.

B BL-22 GRADE I **C BL-22 GRADE II**

RECEIVER Steel • Blued finish • Grooved for scope mounts • Grade II is scroll engraved **BARREL** Blued finish • Recessed crown **ACTION** Lever-action • Short 33° lever throw • Tubular magazine • Grade II has gold-colored trigger **STOCK** Gloss finish American walnut • Straight grip • Grade II has cut checkering **FEATURES** Adjustable sights with front bead

NEW 2015	CALIBER	CODE NUMBER	SUGGESTED RETAIL	BARREL LENGTH Inches	TOTAL CAPACITY Includes one in the chamber	AVERAGE WEIGHT Lbs. / Oz.	OVERALL LENGTH Inches	SIGHT RADIUS Inches	DROP AT COMB Inches	DROP AT HEEL Inches	LENGTH OF PULL Inches	RATE OF TWIST Inches
BL-22 GRADE I MICRO MIDAS												
A	22 LR	024115103	579.99	16-1/4	12	4 / 12	31-1/2	11-5/8	7/8	1-1/2	12	16
BL-22 GRADE I												
B	22 S, L & LR	02410103	619.99	20	16 LR	5 / 0	36-3/4	15-3/8	7/8	1-1/2	13-1/2	16
BL-22 GRADE II												
C	22 S, L & LR	024101103	699.99	20	16 LR	5 / 0	36-3/4	15-3/8	7/8	1-1/2	13-1/2	16

MORE THAN A “22”.

Fine walnut and a satin nickel finish perfectly complement the slick function of the BL-22 rifles below. While the heirloom quality is evident, these well balanced little rifles demand to be used and enjoyed.



D BL-22 GRADE I, FULL LINE DEALER



E BL-22 GRADE II, FULL LINE DEALER

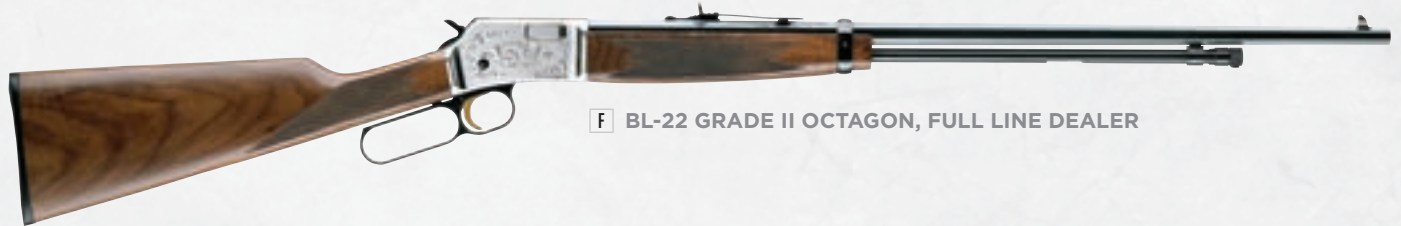

F BL-22 GRADE II OCTAGON, FULL LINE DEALER

D BL-22 GRADE I, FULL LINE DEALER E BL-22 GRADE II, FULL LINE DEALER

RECEIVER Steel • Satin nickel finish • Grooved for scope mounts • Grade II is scroll engraved **BARREL** Blued finish • Recessed crown **ACTION** Lever-action • Short 33° lever throw • Tubular magazine • Grade II has gold-colored trigger **STOCK** Satin finish American walnut • Straight grip • Grade II has cut checkering **FEATURES** Adjustable sights with front bead • Available only from Browning Full Line and Medallion Dealers

F BL-22 GRADE II OCTAGON, FULL LINE DEALER

RECEIVER Steel • Satin nickel finish • Grooved for scope mounts • Scroll engraved **BARREL** Octagonal • Blued finish • Recessed crown **ACTION** Lever-action • Short 33° lever throw • 3/4 length tubular magazine • Gold-colored trigger **STOCK** Satin finish American walnut • Straight grip • Cut checkering **FEATURES** Adjustable sights with front gold bead • Available only from Browning Full Line and Medallion Dealers

NEW 2015	CALIBER	CODE NUMBER	SUGGESTED RETAIL	BARREL LENGTH Inches	TOTAL CAPACITY Includes one in the chamber	AVERAGE WEIGHT Lbs. / Oz.	OVERALL LENGTH Inches	DROP AT COMB Inches	DROP AT HEEL Inches	LENGTH OF PULL Inches	RATE OF TWIST Inches
BL-22 GRADE I, FULL LINE DEALER											
D	22 S, L & LR	024107102	659.99	20	16 LR	5 / 0	36-3/4	7/8	1-1/2	13-1/2	16
BL-22 GRADE II, FULL LINE DEALER											
E	22 S, L & LR	024108102	749.99	20	16 LR	5 / 0	36-3/4	7/8	1-1/2	13-1/2	16
BL-22 GRADE II OCTAGON, FULL LINE DEALER											
F	22 S, L & LR	024105155	979.99	24	16 LR	5 / 4	40-3/4	7/8	1-1/2	13-1/2	16



PURE GENIUS FROM THE MAN HIMSELF.

Straight from the workbench of John M. Browning comes the SA-22. One of the famous inventor's most time-honored and cherished designs, these compact, takedown rifles are a perfect reminder of the talents of the greatest gun designer in history.



TAKEDOWN FEATURE

- The Semi-Auto 22 can be quickly taken down to a compact length of only 19-3/8" for storage or packing.



BARREL ADJUSTMENT

- The knurled knob allows play to be adjusted out of the barrel to ensure accuracy.



IN-STOCK MAGAZINE

- The magazine is located in the stock to maintain the trim dimensions of the rifle.



BOTTOM EJECTION

- Bottom ejection makes the Semi-Auto 22 ideal for right- or left-handed shooters alike.

ALL BROWNING FIREARMS ARE SHIPPED WITH A FREE LOCKING DEVICE TO ASSIST IN THE SAFE STORAGE OF FIREARMS.





A SEMI-AUTO 22 GRADE I



B SEMI-AUTO 22 GRADE VI BLUED



C SEMI-AUTO 22 GRADE VI GRAYED



Grade VI Engraving, Right

A SEMI-AUTO 22 GRADE I

RECEIVER Steel • Takedown design • Polished blued finish • Scroll engraving **BARREL** Polished blued finish • Drilled and tapped for scope mounts **ACTION** Autoloading • Bottom ejection • Tubular magazine • Crossbolt safety **STOCK** Gloss finish select American walnut • Checkered **FEATURES** Adjustable sights with gold bead front sight blade and folding leaf rear sight • Blued trigger

B SEMI-AUTO 22 GRADE VI BLUED

C SEMI-AUTO 22 GRADE VI GRAYED

RECEIVER Steel • Takedown design • Polished blued or satin grayed finish • Game scene engraving with 24 karat gold accents **BARREL** Polished blued finish • Drilled and tapped for scope mounts **ACTION** Autoloading • Bottom ejection • Tubular magazine • Crossbolt safety **STOCK** Gloss finish select American walnut • Checkered **FEATURES** Adjustable sights with gold bead front sight blade and folding leaf rear sight • Gold trigger

NEW 2015	CALIBER	CODE NUMBER	SUGGESTED RETAIL	BARREL LENGTH Inches	TOTAL CAPACITY Includes one in the chamber	AVERAGE WEIGHT Lbs. / Oz.	OVERALL LENGTH Inches	SIGHT RADIUS Inches	DROP AT COMB Inches	DROP AT HEEL Inches	LENGTH OF PULL Inches	RATE OF TWIST Inches
SEMI-AUTO 22 GRADE I												
A	22 LR	021001102	699.99	19-3/8	11	5 / 3	37	16-1/4	1-3/16	2-5/8	13-3/4	16
SEMI-AUTO 22 GRADE VI BLUED												
B	22 LR	021002102	1,579.99	19-3/8	11	5 / 3	37	16-1/4	1-3/16	2-5/8	13-3/4	16
SEMI-AUTO 22 GRADE VI GRAYED												
C	22 LR	021003102	1,579.99	19-3/8	11	5 / 3	37	16-1/4	1-3/16	2-5/8	13-3/4	16

RIGHT ON THE MARK.

Based on the reliable Buck Mark pistol, the Buck Mark Rifle is the perfect rimfire for plinking. These compact rifles are nimble, simple to operate, easy to load, accurate and pure fun. The frame is machined from a solid block of 7075-T6 aluminum for strength and longevity.

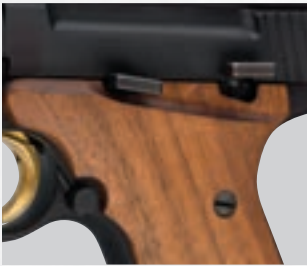

SAFETY AND SLIDE RELEASE

- Large manual thumb safety.
- The convenient manual slide release is easily operated with the shooting or support hand.



SIGHTS

- Sporter model features a TRUGLO[®]/Marble Arms[®] fiber-optic sight system.
- The rear sight is adjustable for windage and elevation.



MAGAZINE RELEASE

- Located adjacent to the trigger guard for convenient operation.



ACTION

- The straight blowback design offers enhanced simplicity and reliability.



FRAME

- Machined to exacting tolerances from a solid billet of 7075-T6 aluminum. The stock structure is a part of the pistol frame, reducing weight and the number of parts.



BARREL

- Sporter model features lightweight, tapered sporter-weight barrel. Target models feature a bull barrel.
- The chamber in every Buck Mark Rifle barrel is hand-reamed and the muzzle crown is recessed to protect it from damage that could degrade accuracy.



SLIDE

- Serrated for an improved cocking grip.



ALL BROWNING FIREARMS ARE SHIPPED WITH A FREE LOCKING DEVICE TO ASSIST IN THE SAFE STORAGE OF FIREARMS.



A BUCK MARK SPORTER



B BUCK MARK TARGET



C BUCK MARK TARGET GRAY LAMINATE, FULL LINE DEALER



A BUCK MARK SPORTER

RECEIVER Alloy • Matte blued finish **BARREL** Tapered sporter • Matte blued finish • Target crown **ACTION** Blowback • Single-action trigger • Detachable magazine **STOCK** Oil finish walnut **FEATURES** TRUGLO®/Marble Arms® adjustable fiber-optic sights • Integral scope rail

B BUCK MARK TARGET

RECEIVER Alloy • Matte blued finish **BARREL** Heavy bull • Matte blued finish • Target crown **ACTION** Blowback • Single-action trigger • Detachable magazine **STOCK** Oil finish walnut **FEATURES** Integral scope rail

C BUCK MARK TARGET GRAY LAMINATE, FULL LINE DEALER

RECEIVER Alloy • Matte blued finish **BARREL** Heavy bull • Matte blued finish • Target crown **ACTION** Blowback • Single-action trigger • Detachable magazine **STOCK** Laminated gray satin finish hardwood **FEATURES** Integral scope rail • Available only from Browning Full Line and Medallion Dealers

NEW 2015	CALIBER	CODE NUMBER	SUGGESTED RETAIL	BARREL LENGTH Inches	TOTAL CAPACITY Includes one in the chamber	AVERAGE WEIGHT Lbs. / Oz.	OVERALL LENGTH Inches	SIGHT RADIUS Inches	DROP AT COMB Inches	DROP AT HEEL Inches	LENGTH OF PULL Inches	RATE OF TWIST Inches
BUCK MARK SPORTER												
A	22 LR	021026102	699.99	18	11	4 / 6	33-5/8	12-3/8	7/8	1-1/2	15-1/8	16
BUCK MARK TARGET												
B	22 LR	021025202	699.99	18	11	5 / 6	33-5/8	—	7/8	1-1/2	15-1/8	16
BUCK MARK TARGET GRAY LAMINATE, FULL LINE DEALER												
C	22 LR	021030202	719.99	18	11	5 / 8	33-5/8	—	7/8	1-1/2	15-1/8	16

ALL-AMERICAN.

Built on a machined aluminum frame and featuring a precision rifled barrel, crisp trigger and fully-adjustable sights, the Browning Buck Mark is a reliable, top notch performer. The Buck Mark is proudly made in the USA.



SAFETY AND SLIDE RELEASE

- Large manual thumb safety.
- The convenient manual slide release is easily operated with the shooting or support hand.



MAGAZINE RELEASE

- Positioned adjacent to the trigger guard for convenient operation.



FRAME

- Machined from aircraft grade aluminum alloy.



SIGHTS

- The 16-click per revolution adjustable Pro-Target™ sight is standard on all models.
- This sight provides a finer degree of adjustment over the industry's standard of 12-clicks per revolution.
- Fiber-optic TRUGLO®/Marble Arms® front sights are available on select models.



MAGAZINE

- The steel magazine body is heat treated for long-term feeding reliability and long life. The coil spring provides a consistent follower angle. 10-round capacity.



ACTION

- The straight blowback design offers enhanced simplicity and reliability.



BARREL

- Most models have bull barrels for improved stability. Lite models have a steel barrel liner inside an ultralight aluminum sleeve.
- The chamber is hand-reamed and the muzzle crown is recessed to protect it from damage that could degrade accuracy.



GRIPS

- Several wood, laminate and composite styles are available. Overmolded Ultragrip FX (UFX), soft nitrile rubber Ultragrip RX® (URX) and wood Ultragrip Deluxe® (UDX) ambidextrous grips have ergonomic finger grooves for enhanced control.



CALIFORNIA MODELS

- Some California approved Buck Mark Pistols include the slide shown on the left, while non California compliant models feature the slide on the right.



ABS CARRY CASE

- Buck Mark pistols are shipped in a sturdy ABS case.



ALL BROWNING FIREARMS ARE SHIPPED WITH A FREE LOCKING DEVICE TO ASSIST IN THE SAFE STORAGE OF FIREARMS.



A BUCK MARK PLUS UDX



B BUCK MARK PLUS STAINLESS UDX



C BUCK MARK STANDARD URX



D BUCK MARK STANDARD STAINLESS URX



E BUCK MARK CAMPER UFX



F BUCK MARK CAMPER STAINLESS UFX

A BUCK MARK PLUS UDX B BUCK MARK PLUS STAINLESS UDX

RECEIVER Alloy • Matte blued finish • Finger grooves **BARREL** Slabside • Stainless or matte blued with polished flats • 5-1/2" length **ACTION** Blowback • Single-action trigger **GRIPS** Ultragrip DX ambidextrous • Brown grips on blued model • Black laminated grips on stainless model **FEATURES** Pro-Target adjustable rear sight • TRUGLO®/Marble Arms® fiber-optic front sight

C BUCK MARK STANDARD URX D BUCK MARK STANDARD STAINLESS URX

RECEIVER Alloy • Blued finish **BARREL** Slabside • 5-1/2" length • Stainless or blued finish with polished flats or **ACTION** Blowback • Single-action trigger **GRIPS** Ultragrip RX ambidextrous **FEATURES** Pro-Target adjustable sights

E BUCK MARK CAMPER UFX F BUCK MARK CAMPER STAINLESS UFX

RECEIVER Alloy • Matte blued **BARREL** Tapered bull • 5-1/2" length • Matte blued or stainless finish **ACTION** Blowback • Single-action trigger **GRIPS** Overmolded Ultragrip FX ambidextrous **FEATURES** Pro-Target adjustable sights

NEW 2015	CA COMPLIANT	CALIBER	CODE NUMBER	SUGGESTED RETAIL	CAPACITY	REAR SIGHT	FRONT SIGHT	BARREL LENGTH Inches	AVERAGE WEIGHT Oz.	OVERALL LENGTH Inches	SIGHT RADIUS Inches
BUCK MARK PLUS UDX											
	•	22 LR	051428490	539.99	10	Adjustable	Fiber-Optic	5-1/2	34	9-1/2	8-1/4
A	•	22 LR	051496490	539.99	10	Adjustable	Fiber-Optic	5-1/2	34	9-1/2	8-1/4
BUCK MARK PLUS STAINLESS UDX											
B	•	22 LR	051427490	579.99	10	Adjustable	Fiber-Optic	5-1/2	34	9-1/2	8-1/4
BUCK MARK STANDARD URX											
	•	22 LR	051407490	469.99	10	Adjustable	Blade	5-1/2	34	9-1/2	8-1/4
C	•	22 LR	051497490	469.99	10	Adjustable	Blade	5-1/2	34	9-1/2	8-1/4
BUCK MARK STANDARD STAINLESS URX											
D	•	22 LR	051409490	499.99	10	Adjustable	Blade	5-1/2	34	9-1/2	8-1/4
BUCK MARK CAMPER UFX											
	•	22 LR	051482490	389.99	10	Adjustable	Blade	5-1/2	34	9-1/2	8-1/4
E	•	22 LR	051498490	389.99	10	Adjustable	Blade	5-1/2	34	9-1/2	8-1/4
BUCK MARK CAMPER STAINLESS UFX											
F	•	22 LR	051483490	429.99	10	Adjustable	Blade	5-1/2	34	9-1/2	8-1/4



A BUCK MARK LITE GRAY URX



C BUCK MARK PRACTICAL URX



B BUCK MARK STANDARD STAINLESS URX



D BUCK MARK HUNTER

INCLUDES PISTOL RUG



E BUCK MARK CONTOUR URX

INCLUDES PISTOL RUG

A BUCK MARK LITE GRAY URX

RECEIVER Alloy • Matte gray finish **BARREL** Alloy sleeved 5-1/2" length • Matte gray finish • Fluted **ACTION** Blowback • Single-action trigger **GRIPS** Ultragrip RX ambidextrous **FEATURES** Pro-Target adjustable rear sight • TRUGLO®/Marble Arms® fiber-optic front sight

B BUCK MARK STANDARD STAINLESS URX

RECEIVER Alloy • Matte blued finish **BARREL** Stainless slabside 5-1/2" length **ACTION** Blowback • Single-action trigger **GRIPS** Ultragrip RX ambidextrous **FEATURES** Pro-Target adjustable sights (Browning Reflex sight and optional scope base not included)

C BUCK MARK PRACTICAL URX

RECEIVER Alloy • Matte gray finish **BARREL** Tapered bull 5-1/2" length • Matte blued finish **ACTION** Blowback • Single-action trigger **GRIPS** Ultragrip RX ambidextrous **FEATURES** Pro-Target adjustable rear sight • TRUGLO®/Marble Arms® fiber-optic front sight

D BUCK MARK HUNTER

RECEIVER Alloy • Matte blued finish **BARREL** Heavy tapered round bull 7-1/4" length • Matte blued finish • Integral scope base **ACTION** Blowback • Single-action trigger **GRIPS** Laminated cocobolo target **FEATURES** Pro-Target adjustable rear sight • TRUGLO®/Marble Arms® fiber-optic front sight • Pistol rug included (not shown)

E BUCK MARK CONTOUR URX

RECEIVER Alloy • Matte blued finish **BARREL** Special contour • Matte blued finish • Full-length scope base • Available in 5-1/2" and 7-1/4" length **ACTION** Blowback • Single-action trigger **GRIPS** Ultragrip RX ambidextrous **FEATURES** Pro-Target adjustable sights • Pistol rug included (not shown)

NEW 2015 CA COMPLIANT	CALIBER	CODE NUMBER	SUGGESTED RETAIL	CAPACITY	REAR SIGHT	FRONT SIGHT	BARREL LENGTH Inches	AVERAGE WEIGHT Oz.	OVERALL LENGTH Inches	SIGHT RADIUS Inches
BUCK MARK LITE GRAY URX										
A	• 22 LR	051461490	579.99	10	Adjustable	Fiber-Optic	5-1/2	28	9-1/2	8-1/4
	• 22 LR	051500490	579.99	10	Adjustable	Fiber-Optic	5-1/2	28	9-1/2	8-1/4
BUCK MARK STANDARD STAINLESS URX										
B	• 22 LR	051427490	579.99	10	Adjustable	Fiber-Optic	5-1/2	34	9-1/2	8-1/4
BUCK MARK PRACTICAL URX										
C	• 22 LR	051448490	439.99	10	Adjustable	Fiber-Optic	5-1/2	34	9-1/2	8-1/4
BUCK MARK HUNTER										
D	• 22 LR	051499490	499.99	10	Adjustable	Fiber-Optic	7-1/4	38	11-1/4	10
BUCK MARK CONTOUR URX										
	• 22 LR	051421490	549.99	10	Adjustable	Blade	5-1/2	36	9-1/2	8-1/4
	• 22 LR	051501490	549.99	10	Adjustable	Blade	5-1/2	36	9-1/2	8-1/4
E	• 22 LR	051502490	559.99	10	Adjustable	Blade	7-1/4	39	11-1/4	9-3/4



85% SIZE, 100% FUN.

Scaled down to 85% of John M. Browning's original 45 ACP Model 1911, the 1911-22 is ideal for plinking, hunting and target shooting. These handsome, Made in the USA sidearms are lightweight and compact, comfortably fitting into hands of every size.

1911  22



SAFETY

- Large manual thumb safety and grip safety.



SLIDE

- Vertical serrations provide an improved cocking grip. The convenient manual slide release is easily operated with the shooting or support hand.



FRAME

- Aircraft grade aluminum alloy or engineering grade composite.
- Walnut grip panels on select models.



ACTION

- The straight blowback design offers enhanced simplicity and reliability.



MAGAZINE

- The steel magazine body is heat treated for long-term feeding reliability and long life.
- The coil spring provides a consistent follower angle.
- 10-round capacity.



MAGAZINE RELEASE

- Positioned adjacent to the trigger guard for convenient operation.



ABS CARRY CASE

- 1911-22 pistols are shipped in a sturdy ABS case.

Made in the USA

ALL BROWNING FIREARMS ARE SHIPPED WITH A FREE LOCKING DEVICE TO ASSIST IN THE SAFE STORAGE OF FIREARMS.



A



B



C



D

1911-22 ACCESSORY GRIPS

	NEW 2015	DESCRIPTION	CODE NUMBER	SUGGESTED RETAIL
A	•	Imitation Aged Ivory Grips	114111	78.00
B	•	Imitation Pearl Grips	114121	78.00
C	•	Rosewood Grips	114131	62.00
D	•	Black Label Grips	114141	62.00



E 1911-22 A1 FULL SIZE, DESERT TAN



F 1911-22 A1 COMPACT, DESERT TAN



G 1911-22 A1 FULL SIZE



H 1911-22 A1 COMPACT

E 1911-22 A1 FULL SIZE, DESERT TAN F 1911-22 A1 COMPACT, DESERT TAN

FRAME Composite • Desert tan color **SLIDE** Machined aluminum • Matte black finish **BARREL** Full Size: 4-1/4", Compact: 3-5/8" length • Stainless steel barrel block • Target crown **ACTION** Blowback • Single-action trigger **GRIPS** Composite **FEATURES** Fixed sights • Detachable 10-round magazine • Manual thumb safety • Grip safety • ABS carry case included

G 1911-22 A1 FULL SIZE H 1911-22 A1 COMPACT

FRAME Alloy • Matte black finish **SLIDE** Machined aluminum • Matte black finish **BARREL** Full Size: 4-1/4", Compact: 3-5/8" length • Stainless steel barrel block • Target crown **ACTION** Blowback • Single-action trigger **GRIPS** Walnut with double diamond pattern cut checkering **FEATURES** Fixed sights • Detachable 10-round magazine • Manual thumb safety • Grip safety • ABS carry case included

NEW 2015 CA COMPLIANT	CALIBER	CODE NUMBER	SUGGESTED RETAIL	CAPACITY	SIGHTS	FINISH	GRIPS	BARREL LENGTH Inches	AVERAGE WEIGHT Oz.	OVERALL LENGTH Inches	SIGHT RADIUS Inches
1911-22 A1 FULL SIZE, DESERT TAN											
E	22 LR	051808490	579.99	10	Fixed	Matte Black	Composite	4-1/4	14	7-3/8	5-1/2
1911-22 A1 COMPACT, DESERT TAN											
F	22 LR	051810490	579.99	10	Fixed	Matte Black	Composite	3-5/8	13-1/2	6-3/4	4-7/8
1911-22 A1 FULL SIZE											
G	• 22 LR	051802490	599.99	10	Fixed	Matte Black	Walnut	4-1/4	15-1/2	7-3/8	5-1/2
1911-22 A1 COMPACT											
H	• 22 LR	051803490	599.99	10	Fixed	Matte Black	Walnut	3-5/8	15	6-3/4	4-7/8

**INCLUDES
ABS CASE**

MORE FEATURES, MORE PERFORMANCE.

Model 1911-22 pistols are accurate and reliable, but it was only a matter of time before we made them better. Black Label models include a host of additional features that are designed to enhance the shooting experience.

1911 22

**EXTENDED AMBIDEXTROUS SAFETY**

- Ambidextrous thumb safety is easy to operate for both right- and left-handed shooters.
- Extended design is easier to reach with the strong hand and ensures secure thumb engagement.

**MAGAZINE**

- The steel magazine body is heat treated for long-term feeding reliability and long life.
- The coil spring provides a consistent follower angle.
- 10-round capacity.

**BEAVERTAIL GRIP SAFETY**

- The beavertail design prevents the hand from being pinched between the grip safety and the hammer.
- Raised bump ensures positive operation.

**FLAT MAINSPRING HOUSING**

- Makes the grip more comfortable for a wider range of shooters.

**FRAME**

- Engineering grade composite.
- Laminated grip panels.

**ABS CARRY CASE**

- 1911-22 pistols are shipped in a sturdy ABS case.

**SIGHTS**

- Combat-style sights offer rapid target acquisition.

**Made
in the USA**

ALL BROWNING FIREARMS ARE SHIPPED WITH A FREE LOCKING DEVICE TO ASSIST IN THE SAFE STORAGE OF FIREARMS.



FUNCTIONAL ADDITIONS.

Black Label 1911-22 handguns include a list of features that shooters seek. An extended thumb safety and slide stop, and a skeletonized hammer make manipulation easier and more positive. The beavertail grip safety prevents hammer bite and the flat mainspring housing ensures more positive operation of the grip safety. Combat-style sights allow for faster target acquisition. Get all this and the reliability we are known for with the Black Label 1911-22.



NEW

A BLACK LABEL 1911-22 FULL SIZE



NEW

B BLACK LABEL 1911-22 FULL SIZE WITH RAIL



NEW

C BLACK LABEL 1911-22 COMPACT



NEW

D BLACK LABEL 1911-22 COMPACT WITH RAIL

FRAME Composite **SLIDE** Machined aluminum • Matte black finish **BARREL** Full Size: 4-1/4", Compact: 3-5/8" length • Stainless steel barrel block • Target crown **ACTION** Blowback • Single-action trigger **GRIPS** Laminated wood **FEATURES** Fixed combat sights • Detachable 10-round magazine • Extended, ambidextrous manual thumb safety • Extended slide release • Beavertail grip safety • Skeletonized hammer • Available with or without accessory rail on dust cover • ABS carry case included

NEW 2015 CA COMPLIANT	CALIBER	CODE NUMBER	SUGGESTED RETAIL	CAPACITY	SIGHTS	FINISH	GRIPS	BARREL LENGTH Inches	AVERAGE WEIGHT Oz.	OVERALL LENGTH Inches	SIGHT RADIUS Inches
BLACK LABEL 1911-22 FULL SIZE											
A •	22 LR	051814490	639.99	10	Fixed	Matte Black	Lam. Wood	4-1/4	14	7-1/2	5-3/8
BLACK LABEL 1911-22 FULL SIZE WITH RAIL											
B •	22 LR	051816490	669.99	10	Fixed	Matte Black	Lam. Wood	4-1/4	14	7-1/2	5-3/8
BLACK LABEL 1911-22 COMPACT											
C •	22 LR	051815490	639.99	10	Fixed	Matte Black	Lam. Wood	3-5/8	13	6-7/8	4-3/4
BLACK LABEL 1911-22 COMPACT WITH RAIL											
D •	22 LR	051817490	669.99	10	Fixed	Matte Black	Lam. Wood	3-5/8	13	6-7/8	4-3/4

**INCLUDES
ABS CASE**

380 ACP POWERHOUSE.

The new 1911-380 pairs two of John M. Browning’s original inventions — the Model 1911 handgun and the 380 ACP cartridge. Scaled down to 85% of the size of the original 45 ACP versions, the single-action 1911-380 utilizes a precision built composite frame and extras like extended controls that make it ideal for sport shooting and personal protection. The 1911-380 is proudly Made in the USA.



EXTENDED AMBIDEXTROUS SAFETY

- Ambidextrous thumb safety is easy to operate.
- Extended design is easier to reach with the strong hand.



BEAVERTAIL GRIP SAFETY

- The beavertail design prevents bite to the hand from the grip safety.
- Raised bump ensures positive operation.



FRAME

- Engineering grade composite.
- Composite grip panels.



SIGHTS

- Combat-style sights offer rapid target acquisition.



MAGAZINE

- The steel magazine body is heat treated for long-term feeding reliability and long life.
- 8-round capacity.



FLAT MAINSPRING HOUSING

- Makes the grip more comfortable for a wider range of shooters.



ABS CARRY CASE

- The 1911-380 pistol is shipped in a sturdy ABS case.



ALL BROWNING FIREARMS ARE SHIPPED WITH A FREE LOCKING DEVICE TO ASSIST IN THE SAFE STORAGE OF FIREARMS.



A



B



C



D

1911-380 ACCESSORY GRIPS

	NEW 2015	DESCRIPTION	CODE NUMBER	SUGGESTED RETAIL
A	•	Imitation Aged Ivory Grips	114111	78.00
B	•	Imitation Pearl Grips	114121	78.00
C	•	Rosewood Grips	114131	62.00
D	•	Black Label Grips	114141	62.00

SIZE MATTERS.

The new Browning 1911-380 combines two of John M. Browning’s most lasting innovations — the Model 1911 and the 380 ACP cartridge — into a modern, lightweight pistol. Unlike most of the modern “pocket pistols” that chamber the snappy 380 ACP cartridge, the 1911-380 is slightly larger to better manage recoil for improved control that makes follow-up shots faster and more accurate. The longer barrel increases bullet velocity for more downrange punch and improved accuracy. The grip is compact, yet it is long and wide enough to allow the shooting hand full purchase for added shooting comfort.

NEW



BLACK LABEL
1911-380 FULL SIZE
(SHOWN ACTUAL SIZE)

FRAME Composite **SLIDE** Machined steel • Matte black finish **BARREL** Rust-resistant, 4-1/4" length • Target crown **ACTION** Locked-breech action • Single-action trigger **GRIPS** Composite **FEATURES** Fixed combat sights • Eight round magazine capacity • Extended, ambidextrous manual thumb safety • Extended slide release • Beavertail grip safety • Skeletized hammer • ABS carry case included

NEW 2015 CA COMPLIANT	CALIBER	CODE NUMBER	SUGGESTED RETAIL	CAPACITY	SIGHTS	FINISH	GRIPS	BARREL LENGTH Inches	AVERAGE WEIGHT Oz.	OVERALL LENGTH Inches	SIGHT RADIUS Inches
BLACK LABEL 1911-380											
•	380 ACP	051904492	669.99	8	Fixed	Matte Black	Composite	4-1/4	17-1/2	7-1/2	5-3/8

**INCLUDES
ABS CASE**

THE STANDARD.

The single-action Browning Hi Power has a proven reputation forged in the hands of generations of law enforcement, military, special operations forces and law abiding citizens. Unlike many modern, composite handguns, the heft of the Hi Power's steel frame aids in recoil control and accuracy for added confidence.

HI POWER



FRAME AND SLIDE

- The frame and slide are built from solid steel and keeps recoil light and manageable for accurate firing, even at a rapid rate. The Hi Power's balance in the hand is impeccable.



SIGHTS

- Hi Power pistols are available with fixed, low-profile three-dot sights. The Hi Power Standard is also available with optional low-profile target sights that are adjustable for windage and elevation.



MAGAZINE CAPACITY

- Double-stack magazine design.
- 13-round magazine capacity. 10-round capacity where required by law. Follow state and local laws regarding magazine capacity.



SAFETY

- A large, ambidextrous manual thumb safety is conveniently located on the frame just above the grip.

ALL BROWNING FIREARMS ARE SHIPPED WITH A FREE LOCKING DEVICE TO ASSIST IN THE SAFE STORAGE OF FIREARMS.



A HI POWER STANDARD



B HI POWER MARK III

INCLUDES ABS CASE

A HI POWER STANDARD

RECEIVER Steel • Polished blued finish **BARREL** 4-5/8" length • Polished blued finish on slide • Low profile fixed or adjustable rear sights with ramped front blade **ACTION** Locked breech • Single-action trigger • Ambidextrous thumb safety **GRIPS** Select walnut panels • Cut checkering **FEATURES** Extra magazine

B HI POWER MARK III

RECEIVER Steel • Black epoxy finish **BARREL** 4-5/8" length • Black epoxy on slide • Low profile fixed sights **ACTION** Locked breech • Single-action trigger • Ambidextrous thumb safety **GRIPS** Composite panels • Thumb rest **FEATURES** Extra magazine

NEW 2015 CA COMPLIANT	CALIBER	CODE NUMBER	SUGGESTED RETAIL	CAPACITY	SIGHTS	FINISH	GRIPS	BARREL LENGTH Inches	AVERAGE WEIGHT Oz.	OVERALL LENGTH Inches	SIGHT RADIUS Inches
HI POWER STANDARD											
	• 9mm	051003393	1,119.99	10	Fixed	Blued	Walnut	4-5/8	32	7-3/4	6-5/16
	9mm	051004393	1,119.99	13	Fixed	Blued	Walnut	4-5/8	32	7-3/4	6-5/16
A	• 9mm	051003493	1,199.99	10	Adj.	Blued	Walnut	4-5/8	32	7-3/4	6-1/2
	9mm	051004493	1,199.99	13	Adj.	Blued	Walnut	4-5/8	32	7-3/4	6-1/2
HI POWER MARK III											
B	• 9mm	051001393	1,109.99	10	Fixed	Matte Black	Molded Composite	4-5/8	32	7-3/4	6-5/16
	9mm	051002393	1,109.99	13	Fixed	Matte Black	Molded Composite	4-5/8	32	7-3/4	6-5/16



MAKE A MASTERPIECE.

Building a custom Browning firearm is an endeavor to be relished. The Browning Custom Shop works closely with the customer to ensure their individual desires and creative ideas are satisfied, from the type of wood to the most unusual engravings desired. Once designed, the project is then placed in the expert hands of highly skilled craftsmen to make the customers dream gun a reality.

The Custom Shop range comprises four grades, each of which includes a certain number of options. As the firearms are produced in Belgium, a multitude of options are available.



PRICE

- Pricing for the basic firearm, before custom enhancement, is available from the sales department at Browning in Morgan, Utah by calling (801) 876-2711. All prices are subject to change due to changing world currencies.

HOW TO BUILD A CUSTOM GUN

- Visit browning.com/custom to view or download the Browning Custom Shop brochure. In addition to showcasing the firearms available, this brochure displays and explains the many grades, engraving patterns, checkering patterns, stock and forearm designs and personal touches available.

HOW TO ORDER

- All inquiries for Custom Gun Shop products will be submitted to headquarters in Morgan, Utah. Once the basic specifications have been determined, a written order should be placed with the Morgan office. The specifications will be reviewed with the Custom Shop in Belgium, and a price and delivery date will be determined.

DELIVERY

- Actual production time will be based on the complexity and detail of the custom order. An approximate delivery date will be furnished with the factory cost quotation.



B25 SIDEPLATE TRAP

With a full sideplate design, the B25 Sporter is the epitome of over and under shotguns. This much appreciated model is generally configured with long barrels and a wide ventilated rib fitted with a mid bead sight.



B25 SPORTER NEW GENERATION

The B25 Sporter New Generation is a new model from the Custom Shop. In addition to an Olympic trigger, this model includes a tapered 5/16" - 7/16" top rib and ventilated side ribs. It is available in 30" and 32" barrel length versions. The adjustable stock is optional.

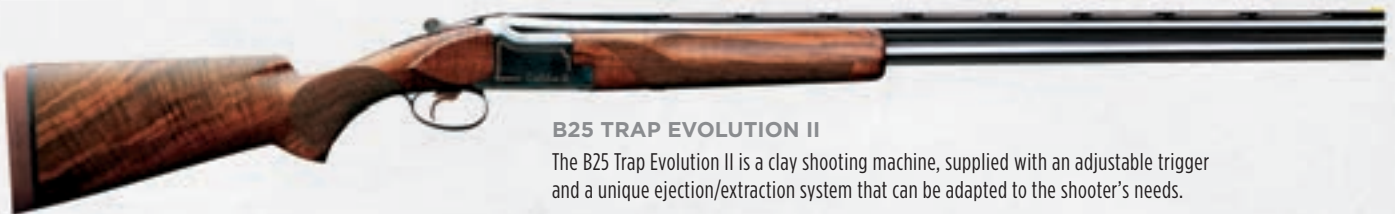

B25 TRAP EVOLUTION II

The B25 Trap Evolution II is a clay shooting machine, supplied with an adjustable trigger and a unique ejection/extraction system that can be adapted to the shooter's needs.

ENGRAVINGS AVAILABLE FOR ALL CUSTOM SHOP MODELS



B25 B2G



B25 The Special



B25 C2G



B25 Diana



B25 D4G

THE LEGENDARY B25.

Handcrafted by Fabrique Nationale d’Herstal in Belgium, Browning Custom Shop B25 shotguns are born in the hands of exceptional craftsmen. These unique models are meticulously made to order and attain perfection at every stage of construction. The finest assembly techniques, the beauty of detail and the love of firearms make these collections works of exceptional luxury.

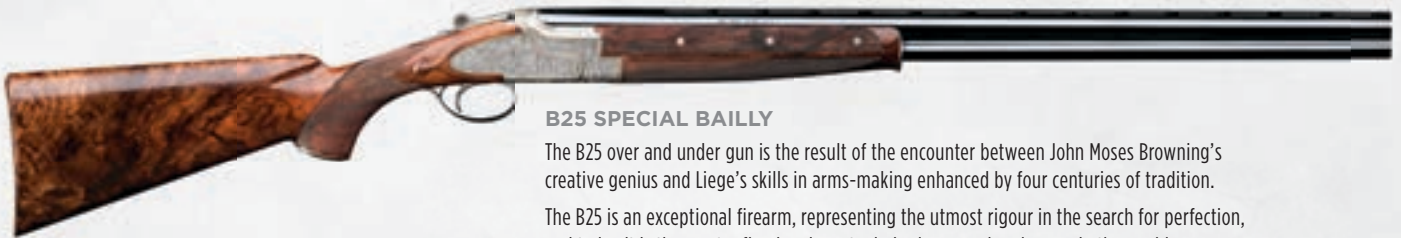

B25 SPECIAL BAILLY

The B25 over and under gun is the result of the encounter between John Moses Browning’s creative genius and Liege’s skills in arms-making enhanced by four centuries of tradition. The B25 is an exceptional firearm, representing the utmost rigour in the search for perfection, and today it is the most refined and most admired over and under gun in the world.



B25 SPECIAL FLOWERS



B25 D5G SIDEPLATE

ENGRAVINGS AVAILABLE FOR ALL CUSTOM SHOP MODELS



B25 D5G



B25 Special Liben



B25 Cheverny



B25 C2S



B25 E1



B25 M1



B25 M2



B25 Special Partridge



B25 Windsor OR



B25 Chenonceau



B25 D5G Sideplate



B25 Ducks Galon



B25 At Rest



B25 Golden Covey



B25 Golden Feather

YOU-NIQUE.

The skilled gunsmiths of the Browning Custom Shop work with you to make your dreams become reality. To learn more, visit browning.com for descriptions of the firearms available, and perhaps even find a source of inspiration for creating your own unique custom Browning.

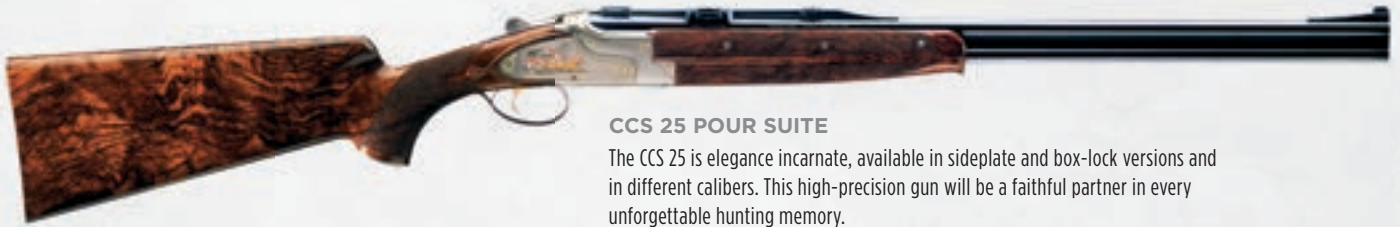

CCS 25 POUR SUITE

The CCS 25 is elegance incarnate, available in sideplate and box-lock versions and in different calibers. This high-precision gun will be a faithful partner in every unforgettable hunting memory.



375 H&H AFRICAN CLASSIC

Custom Shop scope and mounts not included.



C5

Custom Shop scope and mounts not included.

CUSTOM CRAFTED PRECISION.

Very few rimfire rifles are worthy of spending time with artisans such as those at the Browning Custom Shop. The classic John M. Browning designed SA-22 is a wonderful exception. The heirloom quality Grade III model shown is one of the most popular versions offered, with beautifully-finished gloss wood and an intricately engraved receiver.

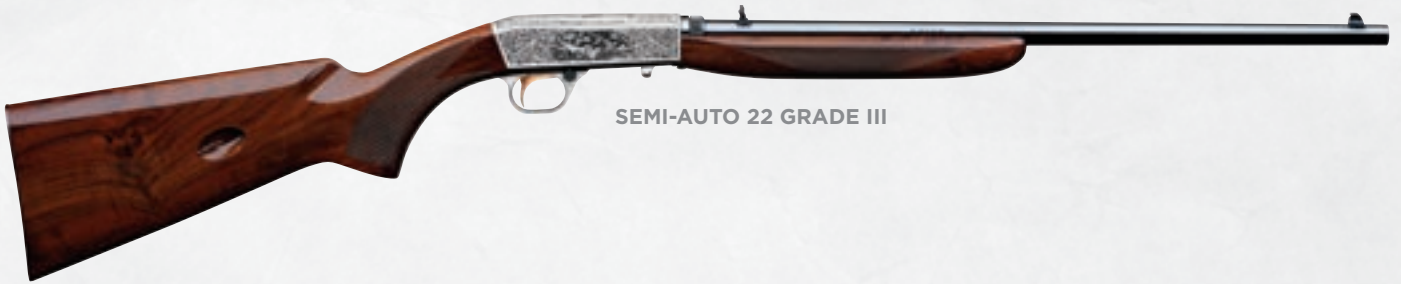

SEMI-AUTO 22 GRADE III

ONE OF THE GREATEST PISTOL DESIGNS OF ALL TIME.

A custom Hi Power offers all the engineering genius of the world's greatest gunmaker, embellished with the beauty and craftsmanship provided by the Browning Custom Shop. A Hi Power Luxus must be seen and held to be fully appreciated.



HI POWER LUXUS 75TH ANNIVERSARY



HI POWER LUXUS
RENAISSANCE SILVER



HI POWER LUXUS
RENAISSANCE GOLD





REAL SAFE-LIKE SECURITY.

Don't skimp on security when looking for a way to secure your handguns. Whether keeping a handgun available for instant protection from bad guys or keeping kids safe, the new Browning ProSteel Pistol Vault has you covered. These feature-packed vaults have steel walls that are twice the thickness of most competitors and include safe-like security measures for superior protection from break-in.



NEW



A



NEW

B

NEW 2015	MODEL	PAINT FINISH	CODE NUMBER	SUGGESTED RETAIL	DIMENSIONS - EXTERIOR H x W x D Inches	WEIGHT Libs.	LOCKING BOLTS Total / Active	STEEL THICKNESS Gauge
A	PISTOL VAULT 1000							
	• PV1000	Textured Black	1601100133	219.00	7-1/2x14-1/2x11	25	2	10
B	PISTOL VAULT 500							
	• PV500	Textured Black	1601100132	199.00	4-1/2x14-1/2x11	21	2	10

**ELECTRONIC 4-BUTTON TOUCH PAD**

Easily program your own personal code to offer ready access to your handguns and small valuables. Uses eight AA batteries. (Not included.)

**PICK AND PLUCK FOAM**

A pick and pluck foam insert allows the Pistol Vault to be customized to your firearms and other valuables. This feature is especially handy if the Pistol Vault is mounted in a vehicle.

**LED LIGHTING**

Bright LED lighting illuminates the interior, making it easy to locate the Pistol Vault's contents at night or in a closet.

**LOCKING BOLTS**

A pair of tough 1/2" diameter locking bolts secure the lid.

**MANUAL KEY LOCK**

Batteries go out? Forget your code? No problem. Access the Pistol Vault anytime using the unique four-sided key.

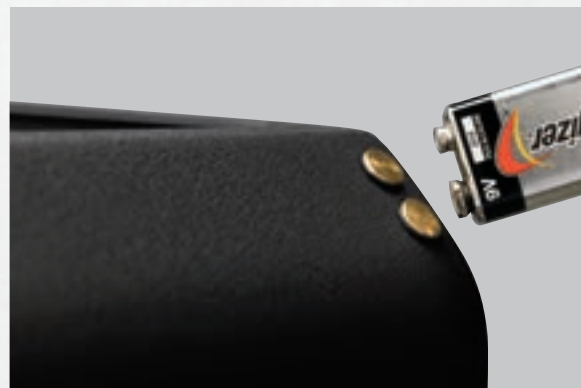
**EXTERNAL ELECTRICAL CONTACTS**

Should the batteries fail or if the key is lost, Pistol Vaults include external electrical contacts that power the touch pad. (9V back up battery not included.)

BETTER THAN THE REST.

While many gun safes look similar standing on a sales floor, you won't find another that lives up to the standards set by Browning. Browning ProSteel safes combine high quality construction, proprietary technology, and patented interior designs to elevate them above the rest. In addition to groundbreaking features, all Browning ProSteel safes carry the UL RSC (Residential Security Container) rating — the industry standard that defines a home security safe and ensures that it meets construction specifications and has passed a series of laboratory test attacks.



Faith in our product is what allows Browning and ProSteel to offer the best warranty in the gun safe industry — a lifetime warranty that covers:

- ATTEMPTED BREAK IN
- BREAK IN
- FIRE

If your safe is involved in one of the above situations and your homeowner's insurance policy does not cover the damage to the safe, ProSteel will repair or replace the safe. (Safe contents are not covered.)

NEW THERMABLOCK FIRE PROTECTION.

When heat builds and flames roar, ThermaBlock ensures that your valuables are well protected. Exclusive to Browning ProSteel Safes, ThermaBlock features thicker sheets of fire insulation arranged in an interlocking design that minimizes gaps that would allow the internal temperature in the safe to rise during a fire.

With ThermaBlock's advantages, we begin fire testing safes where the other brands' testing ends. The chart below shows the temperatures a Browning ProSteel safe is subjected to at different durations compared to the competition.

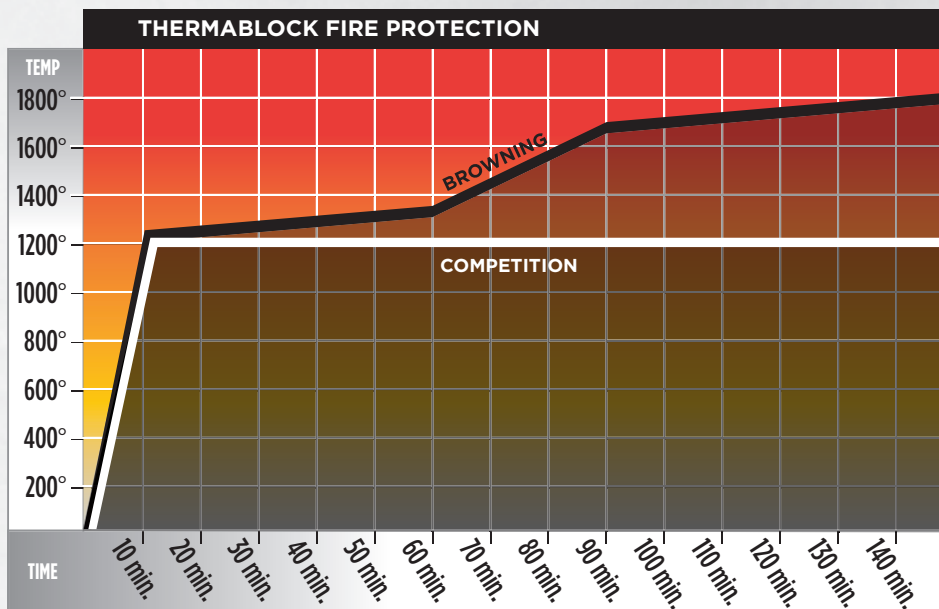

NEW
ThermaBlock



THERMABLOCK INTERLOCKING DESIGN

BE MORE SECURE WITH A BROWNING PROSTEEL SAFE.



DUO-FORMED DOOR

The best Browning ProSteel safe door is made from multiple layers of steel formed together to provide superior strength, pry resistance and attack protection. Full second panel for outstanding strength. The door face is 1-5/16" thick.

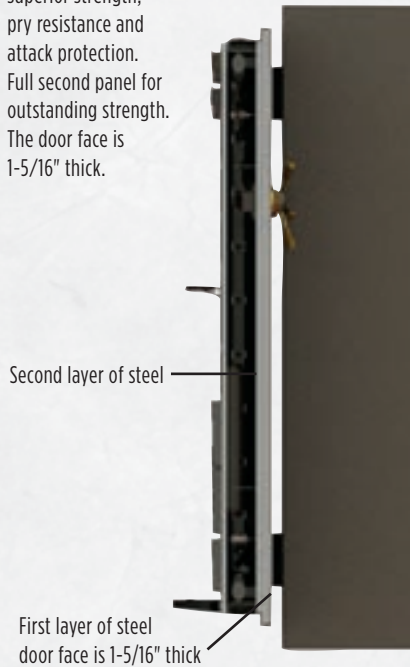

1" FORMED DOOR

The 1" Formed Door is engineered with a rugged steel face. Back and reinforcement panels provide excellent strength and attack protection compared to the competition.



REINFORCED DOOR FRAME

The door opening of the safe is strengthened by an integrated return flange to create added pry and attack resistance.



UNI-FORCE™ LOCKING SYSTEM

The finest Browning ProSteel safe locking mechanism uses robust cam locks and a large, multiple diversion bar system to prevent bolt or handle pressure from reaching the lock. Forces go to the cams and diversion bars, not the lock, for protection unmatched by other locking systems.



OMNIBARRIER® LOCK PROTECTION SYSTEM

A carefully engineered structure of steel hard plate and steel components designed to protect the safe lock from drill, punch and push attacks.



FORCE DEFLECTOR™ LOCKING SYSTEM

The Force Deflector Locking System (U.S. patent #7,665,405) prevents bolt or handle forces from reaching the lock by using a rotating cam device. It prevents energy transfer to the lock better than most systems used in the safe industry.



PRY-STOP CORNER BOLTS

Pry-Stop Corner Bolts (U.S. patent #8,276,527) provide better protection than other pry-defense designs. Innovative long locking bolts extend diagonally from a reinforced support at the corners of the door to protect against pry attack at the vulnerable corner areas.



PRY-STOP END BOLTS

Superior to other bolt designs which allow the locking bolt support bar to bend. Pry-Stop End Bolts are over two and one-half times longer and attach to a high-strength steel angle iron that prevents the locking bolt support bar from bending in a pry attack. The top and bottom locking bolts on the door side secure the critical door corners.



PRY-STOP TABS

Pry-Stop Tabs are pieces of angled steel added to the top and bottom bolts and inside of the safe door. These reinforcements work together to increase pry resistance.



180° HEAVY DUTY HINGES

Rugged hinges allow the door to swing open 180° for unhindered access to the safe interior. Door locking bolts maintain security if the hinges are cut off. Fire protection is better than with internal hinges because no insulation is removed to accommodate the hinges.

THE BEST THERE IS FOR CONVENIENCE AND STORAGE SOLUTIONS.

A gun safe is more than total long gun capacity. Handguns, cameras, jewelry, documents, even laptops and external hard drives with thousands of digital photographs should have a home inside. Browning ProSteel safes have the most versatile interiors in the industry, bar none.



ONE-OF-A-KIND AXIS ADJUSTABLE SHELVING

When it comes to maximizing safe interior storage, Browning ProSteel safes lead the industry with unmatched versatility. The exclusive Axis Adjustable Shelving (U.S. patent #D662341) is a completely customizable system with an array of shelves that can be configured to meet virtually every need. Unlike shelves in the competitors' safes that are either fixed in position or only offer vertical adjustment, Axis shelves can be adjusted up and down, side to side, added and removed to accommodate items over a broad range of sizes. Axis maximizes the interior storage of long guns, handguns and other valuables. Several different shelves and options are available (see page 106) to further customize the interior to meet specific needs. The Axis shelf is made from a single piece of sturdy steel. Shelves are clad in a soft, protective polymer coating that is highly durable and designed to protect guns and valuables. It also adds a sleek appearance to the safe interior. Axis accessories are designed to easily mount to the solid steel shelf or barrel rack. (Compatible with safes that feature Axis Adjustable Shelving built in 2013 or later.)



CANTILEVERED MODULAR SHELVING

Creative interior storage solutions don't end with Browning ProSteel Custom Collection models. Cantilevered Modular Shelving borrows essential components from the patented Axis Adjustable Shelving (U.S. patent #D662341) to retain much of the adjustability of the higher-end system. Like Axis, Cantilevered Modular shelves can be adjusted up and down, side to side, added and removed to fit a wide range of valuables. The shelves are wood covered in soft carpet and built upon a tough steel frame.



MORE GUN STORAGE WITH BROWNING'S DPX SCOPE SAVER SYSTEM

Any way you look at it, a scoped long gun takes up the space of two guns in a safe, except with the DPX Scope Saver. The Scope Saver takes advantage of space no other manufacturer has ever thought of using, the space in the door, to fit a scope. With the scope recessed in the door, the gun takes up no more space than an unscoped long gun. And because the Scope Saver is integrated into the DPX door panel, these scoped long guns are right at your fingertips, easy to access as soon as the door swings open.

The DPX Scope Saver is neatly molded into the door panel and uses the area inside the door to create space for optics mounted on long guns. This unique, one-of-a-kind rack maximizes long gun storage and isolates and protects your optics from the usual bumps that occur when moving guns in and out of a safe. Look for the DPX Storage System and the exclusive Scope Saver on Browning ProSteel Custom Collection safes.

With the Scope Saver, long guns with optics now fit on the DPX rack without taking up space inside the safe body. The optics are also protected from the bumps and dings of guns going into and out of the safe.

NO SPACE GOES UNUSED WITH DPX.



THE DPX ADVANTAGE

The patented DPX storage system (U.S. patent #7,409,790) is available exclusively on Browning ProSteel safes. This unequalled organizational tool allows long guns, handguns, shooting gear and more to be stored on the back of the safe door. The DPX gun rack creates as much as 50% more long gun capacity inside the safe, and makes the guns on the door easy to access. The Scope Saver increases storage and protects optics. DPX pouches and pockets hold valuables and gear where they are easy to find and free up shelf space for even more items.

CAPACITY COMPARISON	COMPETITORS SAFE 25-28 CUBIC FT. SAFE	BROWNING PROSTEEL SAFE 26 CUBIC FT. SAFE	RESULT
TOTAL GUN CAPACITY - HALF SHELF INTERIOR	12 Guns	18 Guns	50% More
TOTAL GUN CAPACITY - ALL GUN INTERIOR	24 Guns	29 Guns	21% More
FAST ACCESS GUNS - HALF SHELF INTERIOR	2 Guns	9 Guns	350% More
FAST ACCESS GUNS - ALL GUN INTERIOR	4 Guns	11 Guns	175% More



THE QUICK ACCESS DPX BARREL RACK

Flexible polymer wings protect the barrel finish, secure the barrel in place and allow firearms to easily be pushed into or pulled from the rack. (U.S. patent #D643500)



MESH POCKETS

See-through mesh pockets hold smaller items and make valuables fast and easy to locate visually.



HOW DO BROWNING SAFES HOLD 50% MORE GUNS?

- The long gun capacity is a series of three numbers, for example 11/22+7 on a 26 Cu. Ft. safe.
- The first number is the long gun capacity in the safe body with a Half Shelf interior (11 in the example).
- The second number is the long gun capacity in the safe body with an All Gun interior (22 in the example).
- The “plus” number is the long gun capacity on the back of the door (+7 in the example).
- Total capacity grows up to 50% in the Half Shelf configuration because there is a full rack of long guns on the door back.
- “Fast Access Guns” increase in both Half Shelf and All Gun configurations. These guns are defined as those that are on the front row of the safe body and the door gun rack.
- * Due to the varying sizes of firearms, actual gun capacity may vary.



DPX HANDGUN POUCHES

The military-style MOLLE system straps on the DPX panel allow handgun pouches and other MOLLE items to be placed virtually anywhere.

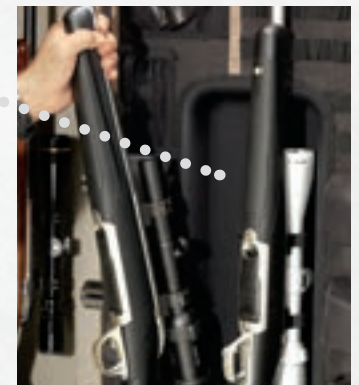

DPX SCOPE SAVER

Store long guns with optics on the DPX door rack with the Scope Saver. The recessed panel protects scopes and increases gun capacity.

PLATINUM PLUS SAFES

SECURITY Heavy duty 3/16" (7-Gauge) steel body • 1-5/16" Thick Duo-Formed® Door with full 10-Gauge inner plate • Uni-Force™ Locking System • OmniBarrier® Lock Protection System • Pry-Stop Corner Bolts • 1-1/2" diameter chromed locking bolts on all four sides of door (top/sides/bottom) **FIRE** New ThermaBlock 1750° F/120 min. fire protection **APPEARANCE** Automotive grade gloss finish in your choice of colors • Pinstripping and choice of scenes • Five-spoke handle in your choice of finishes • Grade VI Cedar interior **CONVENIENCE** Premium DPX Storage System with Quick Access Barrel Rack and Scope Saver • Axis Adjustable Steel Shelving with Drawer and Multipurpose Insert, File Box and Pistol Rack • Elevated floor protects gun stocks • Electrical Outlet • Interior Light Package

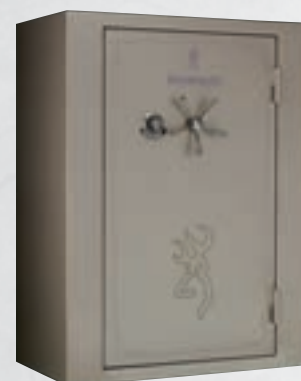



AXIS FILE BOX

Important documents may be irreplaceable and need to be easy to find. Keep track of them in the convenient File Box.

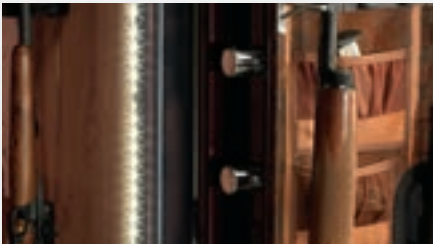

GRADE VI INTERIOR/LED LIGHTING

A fragrant cedar interior adds a rich quality to the safe. Interior LED lighting along the door frame makes locating items inside the safe much easier.



AXIS DRAWER AND MULTIPURPOSE INSERT

The Axis Drawer mounts beneath an Axis steel shelf and includes a Multipurpose Insert that keeps small items organized, easy to locate and protected.

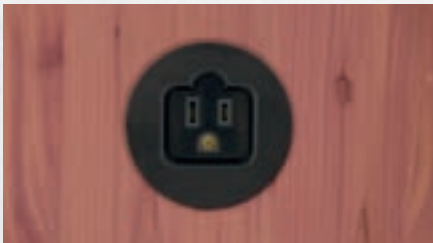

ELECTRICAL OUTLET

The Electrical Outlet allows electrical accessories to be added without taking apart power cords.

WHY STEP UP TO A PLATINUM PLUS SAFE?

Stepping up to a Platinum Plus model gives you the advantage of an exquisite Grade VI Cedar interior for a unique appearance. Thicker 3/16" (7-Gauge) steel adds additional mass and rigidity, while larger (1-1/2") locking bolts and four corner locking bolts offer greater security and protection. A superior ThermoBlock 1750°/120 minute fire rating keeps valuables protected longer. An Axis Drawer with Multipurpose Insert and File Box are included.

NEW 2015	LOCKS (SEE PAGE 92)
	S&G Mechanical
	S&G Electronic
	SecuRam ScanLogic Biometric
	HARDWARE/TRIM COLORS (SEE PAGE 92)
	Silver Chrome
	Black Chrome
	Gold
	GLOSS TWO-TONE FINISH COLORS (SEE PAGE 92)
	Steel Dawn
	Desert Smoke
	Crimson Fade
	GLOSS FINISH COLORS (SEE PAGE 92)
	Black Cherry
	Black
	Hunter Green Metallic
	Titanium Metallic
	Charcoal Metallic
	Matte Black
	GRAPHICS (SEE PAGE 93)
	Buckmark
	Elk
	Mule Deer
	Whitetail Buck/Doe
Pointer	
Mallards	
Mountain	
Scroll	
No Scene	
HERITAGE GRAPHICS (SEE PAGE 93)	
Ducks Unlimited	
• Ducks Unlimited Logo	
National Rifle Association	
National Wild Turkey Federation	
Rocky Mountain Elk Foundation	

NEW 2015	MODEL	PAINT FINISH	CODE NUMBER	SUGGESTED RETAIL	VOLUME	DIMENSIONS - EXTERIOR H x W x D Inches	DIMENSIONS - INTERIOR H x W x D Inches	WEIGHT lbs.	LOCKING BOLTS Total / Active	TOTAL INSULATION Door / Body / Ceiling Inches	STEEL THICKNESS Gauge	STANDARD SHELVES Quantity	BARREL RACKS Quantity	PISTOL RACKS Quantity	TOTAL LONG GUN CAPACITY Gun capacity may vary depending on gun sizes
A PLATINUM PLUS TALL EXTRA WIDE (SHOWN IN BLACK CHERRY WITH ELK)															
•	PP66	Two-Tone Gloss	1601100135 1601100136	8,699.00 8,399.00	66	72x59x27	66x51x17	1920	28	2-3/8 • 3-1/8 • 2-1/2	7	12	4	2	59 (22/46+13)
B PLATINUM PLUS TALL WIDE (SHOWN IN GLOSS BLACK WITH POINTER)															
•	PP52	Two-Tone Gloss	1601100137 1601100138	7,299.00 6,999.00	52	72x46x27	66x39x17	1620	28	2-3/8 • 3-1/8 • 2-1/2	7	8	3	1	43 (22/33+10)
C PLATINUM PLUS WIDE (SHOWN IN TITANIUM METALLIC WITH BUCKMARK)															
•	PP43	Two-Tone Gloss	1601100139 1601100140	6,249.00 6,199.00	43	60x46x27	54x39x17	1425	24	2-3/8 • 3-1/8 • 2-1/2	7	5	3	1	43 (22/33+10)



MEDALLION SAFES

SECURITY 10-Gauge steel body • 1-5/16" Thick Duo-Formed® Door with full 10-Gauge inner plate • Uni-Force™ Locking System • OmniBarrier® Lock Protection System • Pry-Stop Corner Bolts • 1-1/4" diameter chromed locking bolts on all four sides of door (top/sides/bottom) **FIRE** New ThermaBlock 1700° F/110 min. fire protection **APPEARANCE** Automotive grade gloss or rugged textured finish • Pinstripping and choice of scenes • Five-spoke handle in choice of finishes • Beige Fabric interior **CONVENIENCE** Premium DPX Storage System with Quick Access Barrel Rack and Scope Saver • Axis Adjustable Steel Shelving with Pistol Rack included • Elevated floor protects gun stocks • Electrical Outlet • Interior Light Package





INTERIOR LIGHT PACKAGE

LED lighting adds even more value to the Medallion Series. A sensor turns on the lights when the door is opened.



UNI-FORCE LOCKING SYSTEM

Robust cam locks and a multiple diversion bar system divert pressure from reaching the lock.



OMNIBARRIER LOCK PROTECTION

Steel hard plate surrounds the lock and protects it from drill, punch and push attacks.



ELECTRICAL OUTLET

The Electrical Outlet allows electrical accessories to be added without taking apart power cords.



PRY-STOP CORNER BOLTS

Innovative long bolts extend diagonally from the corners of the door to protect against pry attack at the vulnerable corner areas.

WHY STEP UP TO A MEDALLION SAFE?

Stepping up to a Medallion safe buys added security with Pry-Stop Corner Bolts, Uni-Force™ Locking System and Omnibarrier® Lock Protection System. Thicker steel (10-Gauge vs. 11-Gauge) means less flex. A higher fire rating (ThermaBlock 1700°/110 min. vs. 1680°/100 min.) is also a benefit. An Interior Light Package is included.

NEW 2015	LOCKS (SEE PAGE 92)
	S&G Mechanical
	S&G Electronic
	SecuRam ScanLogic Biometric
	HARDWARE/TRIM COLORS (SEE PAGE 92)
	Silver Chrome
	Black Chrome
	Gold
	GLOSS TWO-TONE FINISH COLORS (SEE PAGE 92)
	Steel Dawn
	Desert Smoke
	Crimson Fade
	GLOSS FINISH COLORS (SEE PAGE 92)
	Black Cherry
	Black
	Hunter Green Metallic
	Titanium Metallic
	Charcoal Metallic
	Matte Black
	TEXTURED FINISH COLORS (SEE PAGE 92)
	Textured Charcoal
	GRAPHICS (SEE PAGE 93)
	Buckmark
	Elk
	Mule Deer
	Whitetail Buck/Doe
	Pointer
	Mallards
Mountain	
Scroll	
No Scene	
HERITAGE GRAPHICS (SEE PAGE 93)	
Ducks Unlimited	
• Ducks Unlimited Logo	
National Rifle Association	
National Wild Turkey Federation	
Rocky Mountain Elk Foundation	

NEW 2015	MODEL	PAINT FINISH	CODE NUMBER	SUGGESTED RETAIL	VOLUME	DIMENSIONS - EXTERIOR H x W x D inches	DIMENSIONS - INTERIOR H x W x D inches	WEIGHT Lbs.	LOCKING BOLTS Total / Active	TOTAL INSULATION Door / Body / Ceiling inches	STEEL THICKNESS Gauge	STANDARD SHELVES Quantity	BARREL RACKS Quantity	PISTOL RACKS Quantity	TOTAL LONG GUN CAPACITY Gun capacity may vary depending on gun sizes
A MEDALLION TALL EXTRA WIDE (SHOWN IN HUNTER GREEN WITH ELK)															
•	M62	Two-Tone	1601100141	5,749.00	62	72x57x26	66x51x17	1510	26	2-3/8 • 2-1/2 • 2-1/2	10	12	4	2	59 (22/46+13)
		Gloss	1601100142	5,449.00											
		Texture	1601100143	4,999.00											
B MEDALLION TALL WIDE (SHOWN IN GLOSS BLACK WITH SCROLL)															
•	M48	Two-Tone	1601100144	4,999.00	48	72x44x26	66x39x17	1255	26	2-3/8 • 2-1/2 • 2-1/2	10	8	3	1	43 (22/33+10)
		Gloss	1601100145	4,699.00											
		Texture	1601100146	4,349.00											
C MEDALLION WIDE (SHOWN IN GLOSS BLACK WITH WHITETAIL BUCK/DOE)															
•	M40	Two-Tone	1601100147	4,499.00	40	60x44x26	54x39x17	1105	18	2-3/8 • 2-1/2 • 2-1/2	10	5	3	1	43 (22/33+10)
		Gloss	1601100148	4,199.00											
		Textured	1601100149	3,899.00											
D MEDALLION STANDARD (SHOWN IN TWO-TONE CRIMSON FADE)															
•	M28	Two-Tone	1601100150	3,549.00	28	60x31x26	54x26x17	895	18	2-3/8 • 2-1/2 • 2-1/2	10	4	2	1	29 (11/22+7)
		Gloss	1601100151	3,249.00											
		Texture	1601100152	2,999.00											



SILVER SAFES

SECURITY New 11-Gauge Steel Body • 1-5/16" Thick Duo-Formed® Door with full 10-Gauge inner plate • Force Deflector™ Locking System • Hardened steel pin lock protection • Pry-Stop End Bolts • 1-1/4" diameter chromed locking bolts on all four sides of door (top/sides/bottom) **FIRE** New ThermoBlock 1680° F/100 min. fire protection **APPEARANCE** Automotive grade gloss or rugged textured finish • Pinstriping and choice of scenes • Five-spoke handle in choice of finishes • Beige Fabric interior **CONVENIENCE** Premium DPX Storage System with Quick Access Barrel Rack and Scope Saver • Axis Adjustable Steel Shelving with Pistol Rack included • Elevated floor protects gun stocks • Electrical Outlet

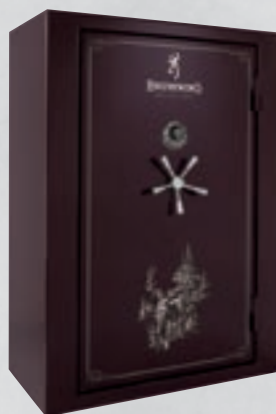

WHY STEP UP TO A SILVER SAFE?

Stepping up to the Silver safe provides you with an elegant Five Spoke handle along with a full selection of finishes, colors and options to select from. Security is heightened thanks to the Duo-Formed door which features a full 10-Gauge inner plate. A higher fire rating (ThermaBlock 1680°/100 min. vs. 1680°/90 min.) and locking bolts on all four sides of the door improve protection from disaster.



ELECTRICAL OUTLET

The Electrical Outlet allows accessories to be added without taking apart power cords.



DPX SCOPE SAVER

Store long guns with optics on the DPX door rack with the Scope Saver. The recessed panel protects scopes and increases gun capacity.



AXIS ADJUSTABLE SHELVING

Multiple shelf styles are available and can be moved to allow small and large items to fit in the safe taking up minimum space.

NEW 2015	LOCKS (SEE PAGE 92)
	S&G Mechanical
	S&G Electronic
	SecuRam ScanLogic Biometric
	HARDWARE/TRIM COLORS (SEE PAGE 92)
	Silver Chrome
	Black Chrome
	Gold
	GLOSS TWO-TONE FINISH COLORS (SEE PAGE 92)
	Steel Dawn
	Desert Smoke
	Crimson Fade
	GLOSS FINISH COLORS (SEE PAGE 92)
	Black Cherry
	Black
	Hunter Green Metallic
	Titanium Metallic
	Charcoal Metallic
	Matte Black
	TEXTURED FINISH COLORS (SEE PAGE 92)
	Textured Charcoal
GRAPHICS (SEE PAGE 93)	
Buckmark	
Elk	
Mule Deer	
Whitetail Buck/Doe	
Pointer	
Mallards	
Mountain	
Scroll	
No Scene	
HERITAGE GRAPHICS (SEE PAGE 93)	
Ducks Unlimited	
• Ducks Unlimited Logo	
National Rifle Association	
National Wild Turkey Federation	
Rocky Mountain Elk Foundation	

	NEW 2015 MODEL	PAINT FINISH	CODE NUMBER	SUGGESTED RETAIL	VOLUME	DIMENSIONS - EXTERIOR H x W x D inches	DIMENSIONS - INTERIOR H x W x D inches	WEIGHT Lbs.	LOCKING BOLTS Total / Active	TOTAL INSULATION Door / Body / Ceiling inches	STEEL THICKNESS Gauge	STANDARD SHELVES Quantity	BARREL RACKS Quantity	PISTOL RACKS Quantity	TOTAL LONG GUN CAPACITY Gun capacity may vary depending on gun sizes
A	SILVER TALL WIDE (SHOWN IN TITANIUM METALLIC WITH SCROLL)														
•	SR45	Two-Tone	1601100153	4,049.00	45	72x43x25	66x39x17	1050	16/10	2-3/8 • 1-7/8 • 2-1/2	11	8	3	1	43 (22/33+10)
		Gloss	1601100154	3,749.00											
		Texture	1601100155	3,399.00											
B	SILVER WIDE (SHOWN IN BLACK CHERRY WITH MULE DEER)														
•	SR37	Two-Tone	1601100156	3,549.00	37	60x43x25	54x39x17	910	16/10	2-3/8 • 1-7/8 • 2-1/2	11	5	3	1	43 (22/33+10)
		Gloss	1601100157	3,249.00											
		Texture	1601100158	2,999.00											
C	SILVER STANDARD (SHOWN IN GLOSS BLACK WITH MALLARDS)														
•	SR26	Two-Tone	1601100159	2,949.00	26	60x30x25	54x26x17	730	16/10	2-3/8 • 1-7/8 • 2-1/2	11	4	2	1	29 (11/22+7)
		Gloss	1601100160	2,649.00											
		Texture	1601100161	2,399.00											



OPTIONS AND ACCESSORIES FOR CUSTOM COLLECTION SAFES

One of the best features of a Custom Collection safe is the number of factory-installed options available. From color, to graphics, to hardware, it's easy to order a safe just the way you want it.

FINISH COLORS



FINISH COLORS

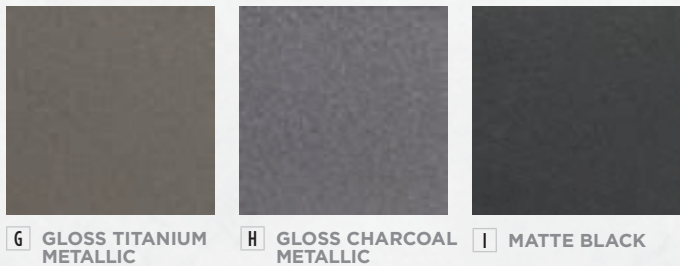

INTERIOR MATERIALS

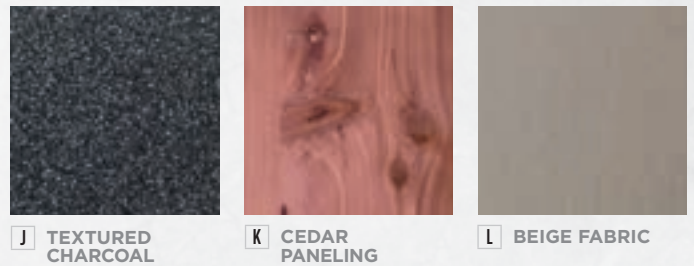

LOCKS

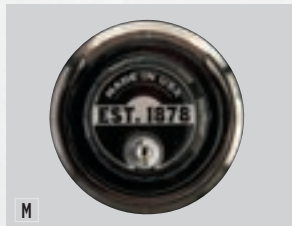

The S&G® Mechanical Lock is the industry standard for security. Manufactured by the leader in the lock industry.

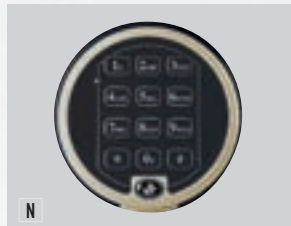

The S&G® Electronic Lock is an advanced security system manufactured by the leader in the lock industry. Includes many technical security features.

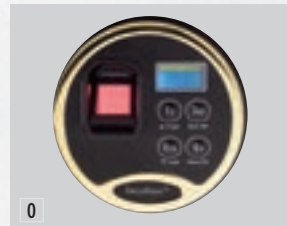

The SecuRam™ ScanLogic Biometric Lock uses the uniqueness of an individual fingerprint as the combination in this advanced security solution. The lock opens with either a fingerprint or a multi-digit code. It is highly secure and operates very quickly. Simple programming instructions. LCD Screen.

HARDWARE/ TRIM COLORS



SILVER CHROME

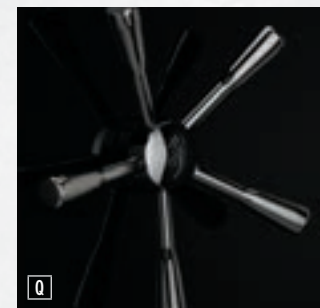

BLACK CHROME



GOLD

GLOSS TWO-TONE FINISH COLORS	
A	Steel Dawn
B	Desert Smoke
C	Crimson Fade
GLOSS FINISH COLORS	
D	Black Cherry
E	Black
F	Hunter Green Metallic
G	Titanium Metallic
H	Charcoal Metallic
I	Matte Black
TEXTURED FINISH COLORS	
J	Textured Charcoal
INTERIOR MATERIALS	
K	Cedar Paneling
L	Beige Fabric
LOCKS	
M	S&G Mechanical
N	S&G Electronic
O	SecuRam ScanLogic Biometric
HARDWARE/TRIM COLORS	
P	Silver Chrome
Q	Black Chrome
R	Gold
LIGHTING	
S	LED Lighting Package



LIGHTING

This integrated LED lighting package makes locating objects on shelves or identifying the right firearm convenient and easy. The four included LED light bars (five on tall safes) are wired to a door-activated motion sensor and illuminate when the door is opened. Factory installation adds a seamless look.

SAFE GRAPHICS

Safe graphics are permanently bonded to the safe door and can only be applied at the factory. Scroll is standard on Custom Collection safes, and the scenes below can be substituted for no extra charge. A "no scene" option is also available.



T BUCKMARK

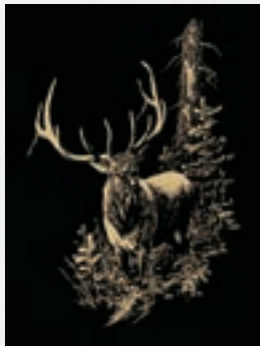

U ELK
BY LEON PARSON

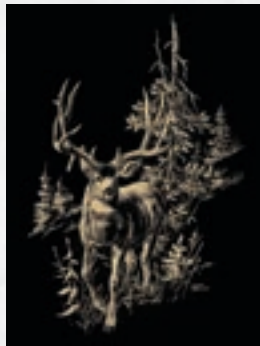

V MULE DEER
BY DAVID JACKSON

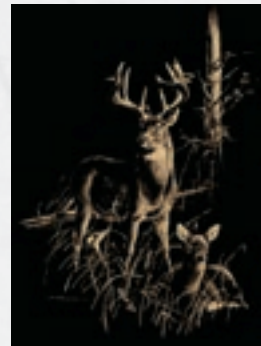

W WHITETAIL BUCK/DOE
BY LUKE FRAZIER

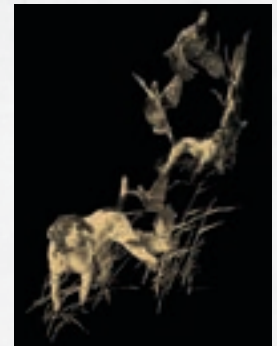

X POINTER
BY LUKE FRAZIER

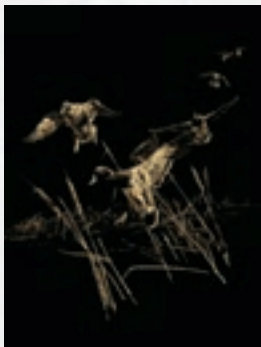

Y MALLARDS
BY LUKE FRAZIER



Z MOUNTAIN
BY DAVID JACKSON



AA SCROLL

A "NO SCENE" OPTION IS NOW AVAILABLE ON SAFES WITH SCENE OPTIONS.

	NEW 2015
	GRAPHICS
T	Buckmark
U	Elk
V	Mule Deer
W	Whitetail Buck/Doe
X	Pointer
Y	Mallards
Z	Mountain
AA	Scroll
	No Scene
	HERITAGE GRAPHICS
BB	Ducks Unlimited
CC	• Ducks Unlimited Logo
DD	National Rifle Association
EE	Rocky Mountain Elk Foundation
FF	National Wild Turkey Federation

HERITAGE GRAPHICS

Support your favorite conservation organization by proudly showing its logo and graphics on a gorgeous Browning ProSteel safe. Every dollar spent on a Heritage Graphic goes to the respective organization.



BB DUCKS UNLIMITED



CC DUCKS UNLIMITED LOGO



DD NATIONAL RIFLE ASSOCIATION

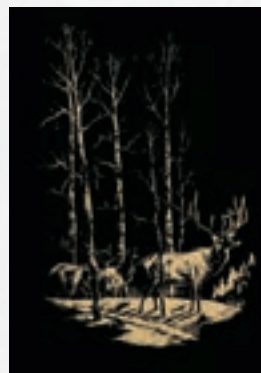

EE ROCKY MOUNTAIN ELK FOUNDATION

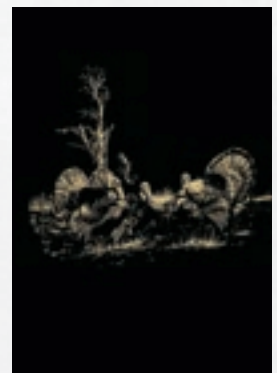

FF NATIONAL WILD TURKEY FEDERATION



HUNTER AND HELL'S CANYON SAFES

SECURITY 11-Gauge steel body • 1" Formed Door with inner plate • Force Deflector™ Locking System • Hardened steel pin lock protection • Pry-Stop End Bolts • 1-1/4" diameter chromed locking bolts on three sides of door (top/sides) **FIRE** New ThermaBlock 1680° F/90 min. fire protection **APPEARANCE** Automotive grade gloss black or rugged textured charcoal finish • Pinstripping and decorative scroll work • Three-spoke chrome handle (Black chrome on Hell's Canyon) • Beige Fabric interior **CONVENIENCE** Premium DPX Storage System with Quick Access Barrel Rack and Scope Saver • Axis Adjustable Shelving with Pistol Rack included • Elevated floor protects gun stocks



A



A



B

NEW 2015 MODEL	PAINT FINISH	GRAPHICS	HARDWARE	LOCK	CODE NUMBER	SUGGESTED RETAIL	VOLUME	DIMENSIONS - EXTERIOR H x W x D inches	DIMENSIONS - INTERIOR H x W x D inches	WEIGHT Lbs.	LOCKING BOLTS Total / Active	TOTAL INSULATION Door / Body / Ceiling Inches	STEEL THICKNESS Gauge	STANDARD SHELVES Quantity	BARREL RACKS Quantity	PISTOL RACKS Quantity	TOTAL LONG GUN CAPACITY Gun capacity may vary depending on gun sizes	
A HUNTER WIDE (SHOWN IN GLOSS BLACK)																		
• HR37	Gloss Black	Scroll	Silver Chrome	SecuRam Electronic	1601100164	3,169.00	37	60x43x25	55x39x17	875	14/8	1-3/4 • 1-7/8 • 1-7/8	11	5	3	1	43 (22/33+10)	
	Gloss Black	Scroll	Silver Chrome	S&G Mechanical	1601100165	3,099.00												
	Textured Charcoal	Scroll	Silver Chrome	SecuRam Electronic	1601100166	2,819.00												
	Textured Charcoal	Scroll	Silver Chrome	S&G Mechanical	1601100167	2,749.00												
B HUNTER STANDARD (SHOWN IN TEXTURED CHARCOAL)																		
• HR26	Gloss Black	Scroll	Silver Chrome	SecuRam Electronic	1601100168	2,519.00	26	60x30x25	55x26x17	700	14/8	1-3/4 • 1-7/8 • 1-7/8	11	4	2	1	29 (11/22+7)	
	Gloss Black	Scroll	Silver Chrome	S&G Mechanical	1601100169	2,449.00												
	Textured Charcoal	Scroll	Silver Chrome	SecuRam Electronic	1601100170	2,269.00												
	Textured Charcoal	Scroll	Silver Chrome	S&G Mechanical	1601100171	2,199.00												



WHY STEP UP TO A HUNTER OR HELL'S CANYON SAFE?

Stepping up to a Hunter or Hell's Canyon safe nets a tough 11-Gauge steel body and larger diameter locking bolts for added security. A ThermaBlock 1680° F/90 min. rating boosts fire protection. Axis Adjustable Shelving adds convenience. These safes are Made in the USA.

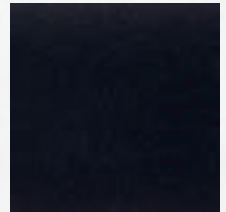

GLOSS BLACK



TEXTURED CHARCOAL

C



HIGH CAPACITY BARREL RACK
The Hell's Canyon model puts a focus on long gun storage with a High Capacity Barrel Rack designed to provide instant access to 41 long guns (13 per rack).



AXIS ADJUSTABLE SHELVING
Multiple shelf styles are available and can be moved to allow small and large items to fit in the safe taking up minimum space.



C

NEW 2015 MODEL	PAINT FINISH	GRAPHICS	HARDWARE	LOCK	CODE NUMBER	SUGGESTED RETAIL	VOLUME	DIMENSIONS - EXTERIOR H x W x D Inches	DIMENSIONS - INTERIOR H x W x D Inches	WEIGHT Lbs.	LOCKING BOLTS Total / Active	TOTAL INSULATION Door / Body / Ceiling Inches	STEEL THICKNESS Gauge	STANDARD SHELVES Quantity	BARREL RACKS Quantity	PISTOL RACKS Quantity	TOTAL LONG GUN CAPACITY Gun capacity may vary depending on gun sizes
C HELL'S CANYON EXTRA WIDE	Textured Charcoal	Hell's Canyon	Black Chrome	SecuRam Electronic	1601100162	3,219.00	48	60x55x25	55x52x17	1055	14/8	1-3/4 • 1-7/8 • 1-7/8	11	8	4	2	65 (39/52+13)
	Textured Charcoal	Hell's Canyon	Black Chrome	S&G Mechanical	1601100163	3,149.00											



HEAVYWEIGHT SAFES

SECURITY 11-Gauge steel body • 1" Formed Door with inner plate • Force Deflector™ Locking System • Hardened steel pin lock protection • Pry-Stop End Bolts • 1-1/4" diameter chromed locking bolts on three sides of door (top/sides) **FIRE** New ThermoBlock 1550° F/80 min. fire protection **APPEARANCE** Automotive grade gloss black or rugged textured charcoal finish • Decorative scroll work • Three-spoke black chrome handle • Beige Fabric interior **CONVENIENCE** Premium DPX Storage System with Quick Access Barrel Rack • Cantilevered Modular Shelving • Elevated floor protects gun stocks

NEW

WHY STEP UP TO A HEAVYWEIGHT SAFE?

Stepping up to a new Heavyweight safe adds a tough 11-Gauge steel body and Pry-Stop End Bolts for improved break-in protection. The excellent 1550° F/80 min. fire rating offers additional protection. A full DPX door storage rack adds storage for valuables, handguns and long guns, while improving access to more long guns. Black chrome hardware adds a rugged appearance.



QUICK ACCESS RACK

Flexible polymer wings secure the barrel and allow firearms to easily be pushed into or pulled from the rack.



PRY-STOP END BOLTS

More than two and one-half times longer than door bolts, they attach to angle iron which prevents the locking bolt support bar from bending in a pry attack. The top and bottom locking bolts on the door secure the critical door corners.



CANTILEVERED MODULAR SHELVING

Quickly and easily adjust the shelving to meet individual storage needs. Barrel racks can be adjusted at various heights to accommodate long guns, as well as shorter carbine models. The cantilevered design eliminates the need for a vertical shelf support to add extra interior space.

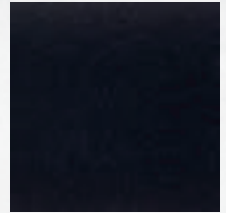

GLOSS BLACK



TEXTURED CHARCOAL

NEW 2015 MODEL	PAINT FINISH	GRAPHICS	HARDWARE	LOCK	CODE NUMBER	SUGGESTED RETAIL	VOLUME	DIMENSIONS - EXTERIOR H x W x D inches	DIMENSIONS - INTERIOR H x W x D inches	WEIGHT lbs.	LOCKING BOLTS Total / Active	TOTAL INSULATION Door / Body / Ceiling inches	STEEL THICKNESS Gauge	STANDARD SHELVES Quantity	BARREL RACKS Quantity	TOTAL LONG GUN CAPACITY Gun capacity may vary depending on gun sizes
A HEAVYWEIGHT EXTRA WIDE (SHOWN IN GLOSS BLACK)																
• HW41	Gloss Black	HW Scroll	Black Chrome	SecuRam Electronic	1601100172	3,069.00	41	60x44x27	55x40x19	910	14/8	1-1/2 • 1-1/2 • 2	11	6	4	56 (22/46+10)
	Gloss Black	HW Scroll	Black Chrome	S&G Mechanical	1601100173	2,999.00										
	Textured Charcoal	HW Scroll	Black Chrome	SecuRam Electronic	1601100174	2,769.00										
	Textured Charcoal	HW Scroll	Black Chrome	S&G Mechanical	1601100175	2,699.00										
B HEAVYWEIGHT WIDE (SHOWN IN TEXTURED CHARCOAL)																
• HW34	Gloss Black	HW Scroll	Black Chrome	SecuRam Electronic	1601100176	2,549.00	34	60x36x27	55x32x19	800	14/8	1-1/2 • 1-1/2 • 2	11	5	3	40 (20/30+10)
	Gloss Black	HW Scroll	Black Chrome	S&G Mechanical	1601100177	2,449.00										
	Textured Charcoal	HW Scroll	Black Chrome	SecuRam Electronic	1601100178	2,379.00										
	Textured Charcoal	HW Scroll	Black Chrome	S&G Mechanical	1601100179	2,349.00										
C HEAVYWEIGHT STANDARD (SHOWN IN GLOSS BLACK)																
• HW24	Gloss Black	HW Scroll	Black Chrome	SecuRam Electronic	1601100180	1,969.00	24	60x30x23	55x26x16	610	14/8	1-1/2 • 1-1/2 • 2	11	4	2	25 (9/18+7)
	Gloss Black	HW Scroll	Black Chrome	S&G Mechanical	1601100181	1,899.00										
	Textured Charcoal	HW Scroll	Black Chrome	SecuRam Electronic	1601100182	1,819.00										
	Textured Charcoal	HW Scroll	Black Chrome	S&G Mechanical	1601100183	1,749.00										
D HEAVYWEIGHT SLIM (SHOWN IN TEXTURED CHARCOAL)																
• HW16	Gloss Black	HW Scroll	Black Chrome	SecuRam Electronic	1601100184	1,819.00	16	60x24x19	55x20x12	480	9/5	1-1/2 • 1-1/2 • 2	11	4	2	19 (7/14+5)
	Gloss Black	HW Scroll	Black Chrome	S&G Mechanical	1601100185	1,749.00										
	Textured Charcoal	HW Scroll	Black Chrome	SecuRam Electronic	1601100186	1,669.00										
	Textured Charcoal	HW Scroll	Black Chrome	S&G Mechanical	1601100187	1,599.00										



SPORTER SAFES

SECURITY 12-Gauge steel body • 1" Formed Door with partial inner plate • Force Deflector™ Locking System • Hardened steel pin lock protection • 1" diameter chromed locking bolts on three sides of door (top/sides) **FIRE** New ThermaBlock 1400° F/60 min. fire protection **APPEARANCE** Gloss black (SP33 & SP23 Only) or hammer gray finish • Three-spoke handle • Beige Fabric interior **CONVENIENCE** DPX Storage System (top half of door back) • Cantilevered Modular Shelving • Elevated floor protects gun stocks

SPORTER COMPACT

SECURITY 12-Gauge steel body • 1" formed steel door • Force Deflector™ Locking Mechanism • Hardened steel pin lock protection • 1" diameter chromed locking bolts • Heavy-duty 180° external hinges • UL® tool attack listed **FIRE** New ThermaBlock 1400° F/60 min. fire protection • Palusol® expanding fire seal • UL Type I Electronic Lock • Baked-on high-gloss finish • Beige two-shelf interior • DPX Door Storage System



C



E



A



B



D



E

WHY CHOOSE A SPORTER SAFE?

Sporter safes offer the quality, security and fire protection features expected from a Browning ProSteel gun safe at a price that is next to impossible to beat. 2015 models include a 1400° F/60 minute fire protection rating for additional peace of mind. The Cantilevered Modular Interior and DPX door storage provide the most versatile interior found in a safe at this price — and above.



QUICK ACCESS RACK

Flexible polymer wings secure the barrel and allow firearms to easily be pushed into or pulled from the rack.



CANTILEVERED MODULAR SHELVING

Quickly and easily adjust the shelving to meet individual storage needs. Barrel racks can be adjusted at various heights to accommodate long guns, as well as shorter carbine models. The cantilevered design eliminates the need for a vertical shelf support to add extra interior space.

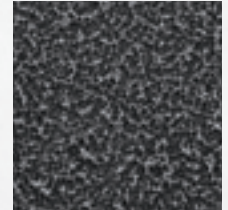

HAMMER GRAY

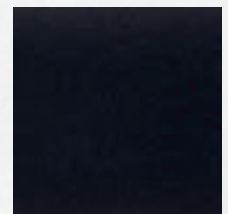

GLOSS BLACK

	MODEL	PAINT FINISH	GRAPHICS	HARDWARE	LOCK	CODE NUMBER	SUGGESTED RETAIL	VOLUME	DIMENSIONS - EXTERIOR H X W X D Inches	DIMENSIONS - INTERIOR H X W X D Inches	WEIGHT Lbs.	LOCKING BOLTS Total / Active	TOTAL INSULATION Door / Body / Ceiling Inches	STEEL THICKNESS Gauge	STANDARD SHELVES Quantity	BARREL RACKS Quantity	TOTAL LONG GUN CAPACITY Gun capacity may vary depending on gun sizes	
A SPORTER EXTRA WIDE																		
•	SP40	Hammer Gray	Scroll	Silver Chrome	SecuRam Electronic	1601100188	2,169.00	40	58x44x27	54x41x20	770	8/5	1 • 1 • 1-1/2	12	8	4	56 (22/46+10)	
		Hammer Gray	Scroll	Silver Chrome	S&G Mechanical	1601100189	2,099.00											
B SPORTER WIDE (SHOWN IN GLOSS BLACK)																		
•	SP33	Gloss Black	Scroll	Silver Chrome	SecuRam Electronic	1601100190	2,119.00	33	58x36x27	54x33x20	665	8/5	1 • 1 • 1-1/2	12	5	3	40 (20/30+10)	
		Gloss Black	Scroll	Silver Chrome	S&G Mechanical	1601100191	2,049.00											
		Hammer Gray	Scroll	Silver Chrome	SecuRam Electronic	1601100192	1,919.00											
		Hammer Gray	Scroll	Silver Chrome	S&G Mechanical	1601100193	1,849.00											
C SPORTER STANDARD (SHOWN IN GLOSS BLACK)																		
•	SP23	Gloss Black	Scroll	Silver Chrome	SecuRam Electronic	1601100194	1,569.00	23	58x30x23	54x27x16	520	8/5	1 • 1 • 1-1/2	12	4	2	25 (9/18+7)	
		Gloss Black	Scroll	Silver Chrome	S&G Mechanical	1601100195	1,499.00											
		Hammer Gray	Scroll	Silver Chrome	SecuRam Electronic	1601100196	1,469.00											
		Hammer Gray	Scroll	Silver Chrome	S&G Mechanical	1601100197	1,399.00											
D SPORTER STANDARD																		
•	SP20	Hammer Gray	Scroll	Silver Chrome	SecuRam Electronic	1601100198	1,319.00	20	58x30x20	54x27x13	495	8/5	1 • 1 • 1-1/2	12	4	2	23 (8/16+7)	
		Hammer Gray	Scroll	Silver Chrome	S&G Mechanical	1601100199	1,249.00											



E SPORTER COMPACT																		
•	SP9	Gloss Black	Scroll	Silver Chrome	SecuRam Electronic	1601100200	1,199.00	9	30x24x20	26x21x16	280	6/3	1 • 1 • 1-1/2	12	2	N/A	N/A	



BLACK LABEL MARK IV SAFES

SECURITY 11-Gauge steel body • 1-5/16" Thick Duo-Formed® Door with full 10-Gauge inner plate • Force Deflector™ Locking System • Hardened steel pin lock protection • Pry-Stop End Bolts • 1-1/4" diameter chromed locking bolts on all four sides of door (top/sides/bottom) **FIRE** New ThermoBlock 1680° F/100 min. fire protection **APPEARANCE** Matte tactical black finish with black chrome hardware and accents • Beige Fabric interior **CONVENIENCE** Premium DPX Storage System with Quick Access Barrel Rack and Scope Saver • Two Carbine Barrel Loops • Axis Adjustable Steel Shelving with Pistol Rack included • Elevated floor protects gun stocks • Interior light package • Electrical Outlet



A

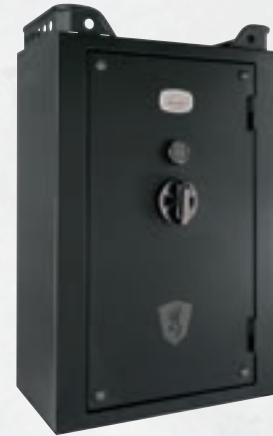

A



B



AXIS ADJUSTABLE SHELVING
Multiple shelf styles are available and can be moved to allow small and large items to fit in the safe using the minimum amount of space. Individual shelves can be adjusted to accommodate modern sporting rifles, carbines and shotguns.



EXTERIOR GEAR LOFT
Tactical and hunting gear can be stored within easy reach on top of the safe in the semi enclosed Gear Loft.



AXIS PISTOL RACK
With a five handgun capacity, the pistol rack stores the pistols under the shelf, leaving the shelf available for possessions and gear.



CARBINE BARREL LOOPS
Lower mounted barrel loops secure shorter rifles and shotguns to the DPX door panel.



NEW 2015 MODEL	PAINT FINISH	GRAPHICS	HARDWARE	LOCK	CODE NUMBER	SUGGESTED RETAIL	VOLUME	DIMENSIONS - EXTERIOR H x W x D Inches	DIMENSIONS - INTERIOR H x W x D Inches	WEIGHT Lbs.	LOCKING BOLTS Total/Active	TOTAL INSULATION Door / Body / Ceiling Inches	STEEL THICKNESS Gauge	STANDARD SHELVES Quantity	BARREL RACKS Quantity	PISTOL RACKS Quantity	TOTAL LONG GUN CAPACITY Gun capacity may vary depending on gun sizes
A BLACK LABEL MARK IV WIDE																	
• US37	Matte Black	Shield	Black Chrome	S&G Electronic	1601100201	4,099.00	37	60x43x25	54x39x20	910	16/10	2-3/8 • 1-7/8 • 2-12	11	5	3	1	43 (22/33+10)
B BLACK LABEL MARK IV STANDARD																	
• US26	Matte Black	Shield	Black Chrome	S&G Electronic	1601100202	3,449.00	26	60x30x25	54x26x20	730	16/10	2-3/8 • 1-7/8 • 2-12	11	4	2	1	29 (11/22+7)



BLACK LABEL MARK III SAFES

SECURITY 12-Gauge steel body • 1" Formed Door with partial inner plate • Force Deflector™ Locking System • Hardened steel pin lock protection • 1" diameter chromed locking bolts on three sides of door (top/sides) **FIRE** New ThermoBlock 1400° F/60 min. fire protection **APPEARANCE** Matte tactical black finish with black chrome hardware and accents • Beige Fabric interior **CONVENIENCE** Full DPX Storage System • Two Carbine Barrel Loops • Cantilevered Modular Shelving • Elevated floor protects gun stocks



A



B

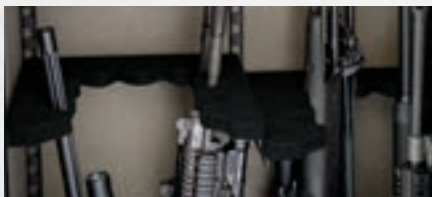

CANTILEVERED MODULAR SHELVING

Quickly and easily adjust the shelving to meet individual storage needs. Barrel racks can be adjusted at various heights to accommodate long guns, as well as shorter carbine models. The cantilevered design eliminates the need for a vertical shelf support to add extra interior space.



DPX STORAGE SYSTEM

Includes a rack on the back of the door to store long guns and make them easier to access. Pouches and pockets help organize other valuables.



CARBINE BARREL LOOPS

Lower mounted barrel loops secure shorter rifles and shotguns to the DPX door panel.

NEW 2015	MODEL	PAINT FINISH	GRAPHICS	HARDWARE	LOCK	CODE NUMBER	SUGGESTED RETAIL	VOLUME	DIMENSIONS - EXTERIOR H x W x D inches	DIMENSIONS - INTERIOR H x W x D inches	WEIGHT Lbs.	LOCKING BOLTS Total / Active	TOTAL INSULATION Door / Body / Ceiling inches	STEEL THICKNESS Gauge	STANDARD SHELVES Quantity	BARREL RACKS Quantity	TOTAL LONG GUN CAPACITY Gun capacity may vary depending on gun sizes
A BLACK LABEL MARK III WIDE																	
•	MP33	Matte Black	Shield	Black Chrome	SecuRam Electronic	1601100203	2,399.00	33	58x36x27	54x33x19	665	8/5	1 • 1 • 1-1/2	12	5	3	40 (20/30+10)
B BLACK LABEL MARK III STANDARD																	
•	MP23	Matte Black	Shield	Black Chrome	SecuRam Electronic	1601100204	1,849.00	23	58x30x23	54x29x16	520	8/5	1 • 1 • 1-1/2	12	4	2	25 (9/18+7)



SELECT SAFES

SECURITY 11-Gauge steel body • 1" Formed Door with inner plate • Force Deflector™ Locking System • Hardened steel pin lock protection • Pry-Stop End Bolts • 1" diameter chromed locking bolts on three sides of door (top/sides) **FIRE** New ThermaBlock 1550° F/80 min. fire protection **APPEARANCE** Gloss Black or Hunter Green Metallic finish • Three-spoke handle • Beige Fabric interior **CONVENIENCE** Full DPX Storage System • Cantilevered Modular Shelving • Elevated floor protects gun stocks



A



A

**NEW
THICKER
STEEL**

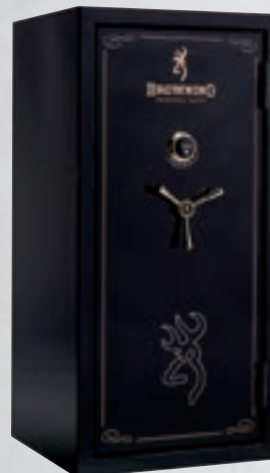

B



Select safes are available only from Browning Full Line and Medallion Dealers.

WHY CHOOSE A SELECT SAFE?

A Select safe offers added security with Pry-Stop End Bolts and a big increase in convenience and capacity thanks to the Quick Access Rack with Scope Saver and full DPX Storage System. The factory-installed LED Interior Light package makes locating items inside the safe easy.



CANTILEVERED MODULAR SHELVING

Quickly and easily adjust the shelving to meet individual storage needs. Barrel racks can be adjusted at various heights to accommodate long guns, as well as shorter carbine models. The cantilevered design eliminates the need for a vertical shelf support to add extra interior space.



PRY-STOP END BOLTS

More than two and one-half times longer than standard door bolts, they attach to angle iron which prevents the locking bolt support bar from bending in a pry attack. The top and bottom locking bolts on the door side secure the critical door corners.



LED INTERIOR LIGHT PACKAGE

LED lighting around the door frame adds value and makes locating items in the safe easier. A pressure sensor turns on the lights when the door is opened.

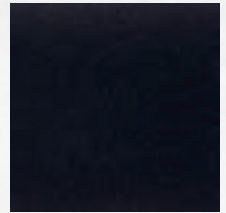

GLOSS BLACK



GLOSS HUNTER GREEN METALLIC

NEW 2015	GRAPHICS (SEE PAGE 93)
Buckmark	
Elk	
Mule Deer	
Whitetail Buck/Doe	
Pointer	
Mallards	
Mountain	
Scroll	
No Scene	
	HERITAGE GRAPHICS (SEE PAGE 93)
Ducks Unlimited	
	• Ducks Unlimited Logo
National Rifle Association	
National Wild Turkey Federation	
Rocky Mountain Elk Foundation	

NEW 2015	MODEL	PAINT FINISH	HARDWARE	LOCK	CODE NUMBER	SUGGESTED RETAIL	VOLUME	DIMENSIONS - EXTERIOR H x W x D inches	DIMENSIONS - INTERIOR H x W x D inches	WEIGHT lbs.	LOCKING BOLTS Total / Active	TOTAL INSULATION Door / Body / Ceiling Inches	STEEL THICKNESS Gauge	STANDARD SHELVES Quantity	BARREL RACKS Quantity	PISTOL RACKS Quantity	TOTAL LONG GUN CAPACITY (gun capacity may vary depending on gun sizes)	
A SELECT WIDE (SHOWN IN HUNTER GREEN METALLIC WITH WHITETAIL BUCK/DOE)																		
•	ST34	Gloss Black	Gold	SecuRam Electronic	1601100205	2,719.00	34	60x36x27	55x33x19	805	14/8	1-1/2 • 1-1/2 • 2	11	5	3	N/A	40 (20/30+10)	
		Gloss Black	Gold	S&G Mechanical	1601100206	2,649.00												
		Gloss Hunter Green Metallic	Gold	SecuRam Electronic	1601100207	2,719.00												
		Gloss Hunter Green Metallic	Gold	S&G Mechanical	1601100208	2,649.00												
B SELECT STANDARD (SHOWN IN GLOSS BLACK WITH BUCKMARK)																		
•	ST24	Gloss Black	Gold	SecuRam Electronic	1601100209	2,069.00	24	60x30x23	55x27x16	615	14/8	1-1/2 • 1-1/2 • 2	11	4	2	N/A	25 (9/18+7)	
		Gloss Black	Gold	S&G Mechanical	1601100210	1,999.00												
		Gloss Hunter Green Metallic	Gold	SecuRam Electronic	1601100211	2,069.00												
		Gloss Hunter Green Metallic	Gold	S&G Mechanical	1601100212	1,999.00												



UNIVERSAL VAULT DOOR

FEATURES Designed to fit a variety of wall types and installation requirements • The minimum rough door opening for the Vault Door is 83" x 36" • External L-frame with 1/2" diameter steel J-bolt anchors (included) can be poured in place in new construction or installed in an existing door frame by using expansion anchors or lag bolts (not included) • Door frame L-flange will fit any wall with a minimum thickness of 5-1/2" • 1-5/16" thick Duo-Formed® door • 22, 1-1/4" chromed locking bolts • OmniBarrier® Lock Protection System • Uni-Force™ Locking System • 1-1/2" of fire-resistant insulation in the door • Knurled five-spoke Buckmark handle • External ball-bearing hinges • Palusol® expanding fire seal • Also available with a black primer finish, allowing you to paint to match any decor • Internal lock release to open the door from within the vault



NEW 2015	LOCKS (SEE PAGE 92)
	S&G Mechanical
	S&G Electronic
	SecuRam ScanLogic Biometric
	HARDWARE/TRIM COLORS (SEE PAGE 92)
	Silver Chrome
	Black Chrome
	Gold
	TWO-TONE FINISH COLORS (SEE PAGE 92)
	Steel Dawn
	Desert Smoke
	Crimson Fade
	GLOSS FINISH COLORS (SEE PAGE 92)
	Black Cherry
	Black
	Hunter Green Metallic
	Titanium Metallic
	Charcoal Metallic
	Matte Black
	GRAPHICS (SEE PAGE 93)
	Buckmark
	Elk
	Mule Deer
	Whitetail Buck/Doe
Pointer	
Mallards	
Mountain	
Scroll	
No Scene	
HERITAGE GRAPHICS (SEE PAGE 93)	
Ducks Unlimited	
• Ducks Unlimited Logo	
National Rifle Association	
National Wild Turkey Federation	
Rocky Mountain Elk Foundation	

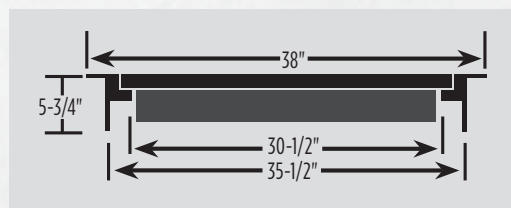

DOOR DIMENSIONS - TOP VIEW



INTERNAL LOCK RELEASE

Allows the door to be opened from inside the vault to prevent accidentally being locked inside.

PAINT FINISH	CODE NUMBER	SUGGESTED RETAIL	VOLUME	DIMENSIONS - EXTERIOR H x W x D, Inches	DIMENSIONS - INTERIOR H x W x D, Inches	WEIGHT Lbs.	LOCKING BOLTS Total / Active	INSULATION LAYERS - DOOR 1/2 inch thick	STEEL THICKNESS Gauge	STANDARD SHELVES Quantity	BARREL RACKS Quantity	PISTOL RACKS Quantity	TOTAL LONG GUN CAPACITY Gun capacity may vary depending on gun sizes
UNIVERSAL VAULT DOOR													
Gloss	1601100075	3,699.00	N/A	83x36	N/A	645	22	3	7	N/A	N/A	N/A	N/A
Primer	1601100076	3,599.00	N/A	83x36	N/A	645	22	3	7	N/A	N/A	N/A	N/A

SECURITY DOOR

FEATURES 1-7/8" thick Duo-Formed® type door • 1-1/4" chromed locking bolts • 1" of fire-resistant insulation in the door face • Residential interior straight brass handle • UL® Listed Type I Electronic Lock • Concealed hinges • Internal lock release to open the door from within the vault • Door swings out a full 180° when open • Minimum rough door opening is 83" x 36"

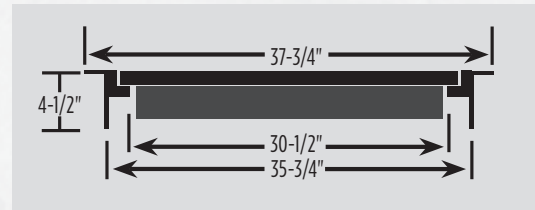

DOOR DIMENSIONS - TOP VIEW

PAINT FINISH	CODE NUMBER	SUGGESTED RETAIL	VOLUME	DIMENSIONS - EXTERIOR H x W x D, Inches	DIMENSIONS - INTERIOR H x W x D, Inches	WEIGHT Lbs.	LOCKING BOLTS Total / Active	INSULATION LAYERS - DOOR 1/2 Inch thick	STEEL THICKNESS Gauge	STANDARD SHELVES Quantity	BARREL RACKS Quantity	PISTOL RACKS Quantity	TOTAL LONG GUN CAPACITY Gun capacity may vary depending on gun sizes
SECURITY DOOR													
Primer	1601100077	4,379.00	N/A	83x36	N/A	500	20/10	2	10	N/A	N/A	N/A	N/A



EXCLUSIVE, CUSTOMIZABLE, ADJUSTABLE SHELVING.

When it comes to maximizing safe interior storage, Browning ProSteel safes lead the industry with unmatched versatility. The exclusive Axis Adjustable Shelving (U.S. patent #D662341) uses an array of shelves that can be configured to meet virtually any need imaginable.



AXIS BOW HANGER
Lock up and protect expensive archery equipment while taking up minimal space.



AXIS SCOPED PISTOL RACK
With a deeper drop and heavy-gauge rods, handguns with optics are easier to store.



AXIS VERTICAL FILE HOLDER
This file holder makes it easier to locate and organize important documents.



AXIS DEEP DRAWER
The Deep Drawer is the perfect home for larger or odd shaped items.



AXIS HIGH CAPACITY BARREL RACK
Make room for more long guns with this high capacity barrel rack.



AXIS PISTOL RACK
With a five handgun capacity, the pistol rack stores the pistols under the shelf, leaving the shelf available for possessions and gear.



AXIS BARREL RACK
With 11 slots for long guns, the barrel rack can be raised or lowered to accommodate rifles, shotguns, carbines and modern sporting rifles.



AXIS STEEL SHELF
The most basic shelf is made from tough steel with a protective polymer skin that protects valuables and handguns.



AXIS DRAWER WITH JEWELRY INSERT
This insert protects and organizes valuables such as watches, rings, bracelets and necklaces.

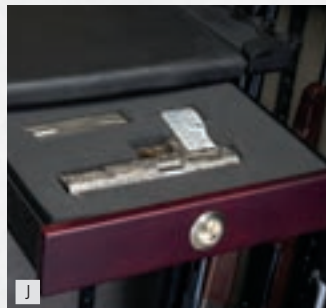

AXIS DRAWER WITH FOAM INSERT
Your most prized possessions can be isolated from potential damage. Pick and pluck foam is easily customized to fit any shape item.

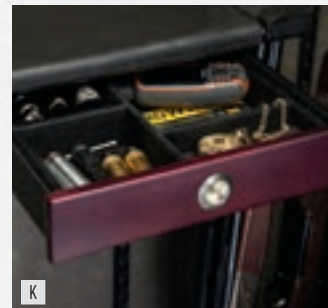

AXIS DRAWER WITH MULTIPURPOSE INSERT
Keep delicate jewelry and other small items organized, protected and easy to find.



AXIS DRAWER WITH MONEY/PASSPORT INSERT
Compartments are sized to organize cash, passports and other documentation.



AXIS DRAWER
The sturdy drawer is perfect for all sorts of goods that need to be separated.



AXIS FILE BOX
Important documents may be irreplaceable or valuable or both. Keep them easy to find in this handy file box.

NEW 2015	DESCRIPTION	CODE NUMBER	SUGGESTED RETAIL
AXIS SHELVING			
A	• Axis Bow Hanger	154117	30.00
B	• Axis Scoped Pistol Rack	154118	17.00
C	• Axis Vertical File Holder	154119	26.00
D	• Axis Deep Drawer	154120	100.00
E	• Axis High Capacity Barrel Rack	154114	27.00
F	Axis Pistol Rack	154102	17.00
G	Axis Barrel Rack	154101	28.00
H	Axis Steel Shelf	154100	30.00
I	Axis Drawer with Jewelry Insert	154108	70.00
J	Axis Drawer with Foam Insert	154109	70.00
K	Axis Drawer with Multipurpose Insert	154103	70.00
L	Axis Drawer with Money/Passport Insert	154113	70.00
M	Axis Drawer	154104	60.00
N	Axis File Box	154105	40.00



LED SAFE LIGHTING KIT

The LED Safe Lighting Kit is the best aftermarket lighting solution available today • The expandable, linear design places bright, long-lasting LED lighting anywhere in the safe • A motion sensor turns on the lights when the door opens and automatically shuts them off after 30 or 60 seconds with no motion or when the door closes • Each kit comes complete with six LED light tubes with six LEDs per tube, three flexible connectors, mounting clips with hook and loop tape, A/C adaptor and a motion sensor power module

CODE NUMBER	SUGGESTED RETAIL
164112	70.00

ZERUST VCI PROTECTANT

Small capsule emits an invisible vapor that forms a corrosion- and rust-resistant barrier on metal surfaces • Volatile Corrosion Inhibitors (VCIs) have been used for years to protect metal parts in industrial and commercial applications • One capsule protects a standard 30" wide safe for one year

CODE NUMBER	SUGGESTED RETAIL
154011	8.00



A



B

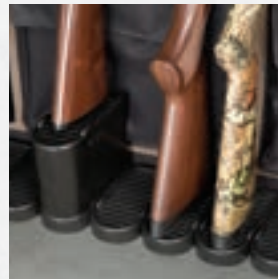

C

DPX ACCESSORIES

Take full advantage of the DPX storage system with these accessories • Store more guns without taking up shelf space with DPX Handgun Pouches (sold in sets of two) • Store shorter firearms and make them easily accessible with DPX barrel loops and DPX stock risers.

	DESCRIPTION	CODE NUMBER	SUGGESTED RETAIL
A	Handgun Pouch	164138	30.00
B	Barrel Loop	164141	26.00
C	Stock Riser	164144	23.00

PISTOL RACK

Store handguns more efficiently • Increases storage space on shelves • Access to handguns is made easier by placing them in an upright position

	DESCRIPTION	CODE NUMBER	SUGGESTED RETAIL
A	6-Gun	164136	30.00
B	4-Gun	164134	20.00



VCI GUN SOCK

VCI (Vapor Corrosion Inhibitor) penetrates into the smallest crevices and drives out moisture where oils cannot reach • Provides full protection by forming a vapor enclosure around the firearm from muzzle to butt • Gives additional protection to all metal items in an enclosed area such as a gun safe or cabinet • Drawstring closure • Fits rifles and shotguns 48" to 56"

CODE NUMBER	SUGGESTED RETAIL
149985	18.00



DRY-ZONE MOISTURE REDUCER

Absorbs moisture without electricity, and is rechargeable in an oven • Can be reactivated indefinitely • One 500-gram box protects up to 37 cubic feet of enclosed space, about the volume of a standard 30" wide safe

CODE NUMBER	SUGGESTED RETAIL
154001	20.00



EVERDRY ELECTRIC DEHUMIDIFIER

The EverDry Electric Dehumidifier removes humidity from the interior of a safe and protects against rust • The 18" long EverDry should be used on safes 30" wide and larger • Cord is removable for installation

CODE NUMBER	SUGGESTED RETAIL
164128	30.00

FLEXIBLE EVERDRY DEHUMIDIFIER

The Flexible EverDry is flat and easily bends • Takes up less space and makes installation easier, especially in small safes • Removes humidity from the interior of a safe and protects against rust • Plug is removable for installation • LED indicates unit is operating

CODE NUMBER	SUGGESTED RETAIL
164129	40.00



S&G® ELECTRONIC LOCK RETROFIT KIT

The S&G Electronic Lock is an advanced security system manufactured by the leader in the lock industry • Includes many technical security features • Kit includes lock and installation DVD (Installation by a professional locksmith is recommended)

DESCRIPTION	CODE NUMBER	SUGGESTED RETAIL
(SHOWN IN SILVER CHROME)		
Silver Chrome	156034	160.00
Black Chrome	156035	160.00
Gold	156036	160.00



SECURAM™ SCANLOGIC BIOMETRIC LOCK RETROFIT KIT

The SecuRam ScanLogic Biometric Lock uses the uniqueness of an individual fingerprint as the combination in this advanced security solution • The lock opens with either a fingerprint or a multi-digit code • It is highly secure and operates very quickly • Simple programming instructions • LCD Screen (Installation by a professional locksmith is recommended)

DESCRIPTION	CODE NUMBER	SUGGESTED RETAIL
(SHOWN IN BLACK CHROME)		
Silver Chrome	156037	360.00
Black Chrome	156038	360.00
Gold	156039	360.00

		PLATINUM PLUS	MEDALLION	SILVER	HUNTER	HELL'S CANYON	HEAVYWEIGHT	SPORTER	SPORTER COMPACT	BLACK LABEL MARK IV	BLACK LABEL MARK III	SELECT	UNIVERSAL VAULT DOOR	SECURITY DOOR	
SECURITY															
STEEL BODY	THICKNESS GAUGE	7	10	11	11	11	11	12	12	11	12	11	—	—	
DOOR TYPE	DUO-FORMED	•	•	•	—	—	—	—	—	•	—	—	•	•	
	1" FORMED	—	—	—	•	•	•	•	•	—	•	•	—	—	
LOCKING SYSTEM	UNI-FORCE	•	•	—	—	—	—	—	—	—	—	—	•	•	
	FORCE DEFLECTOR	—	—	—	•	•	•	•	•	•	•	•	—	—	
LOCK PROTECTION	OMNIBARRIER	•	•	—	—	—	—	—	—	—	—	—	•	—	
	HARDENED STEEL PINS/RELOCKER	—	—	—	•	•	•	•	•	•	•	•	—	•	
LOCKING BOLTS	DIAMETER INCHES	1-1/2	1-1/4	1-1/4	1-1/4	1-1/4	1	1	1	1-1/4	1	1	1-1/4	1-1/4	
LOCKING BOLT LOCATION	DOOR TOP	•	•	•	•	•	•	•	—	•	•	•	•	—	
	DOOR SIDES	•	•	•	•	•	•	•	•	•	•	•	•	•	
	DOOR BOTTOM	•	•	•	—	—	—	—	—	•	—	—	•	—	
PRY-STOP BOLTS	TOTAL	Corner-4	Corner-2	End-2	End-2	End-2	End-2	—	—	End-2	—	End-2	—	—	
LOCK OPTIONS	UL RATED BIOMETRIC	•	•	•	•	•	—	—	—	—	—	—	•	•	
	UL RATED ELECTRONIC	•	•	•	•	•	•	•	•	•	•	•	•	•	
	UL RATED MECHANICAL	•	•	•	•	•	•	•	—	—	—	•	—	—	
UL SECURITY LISTING	RSC TOOL ATTACK	•	•	•	•	•	•	•	•	•	•	•	—	—	
FIRE															
TEMPERATURE RATING	DEGREES FAHRENHEIT	1750	1700	1680	1680	1680	1550	1400	1400	1680	1400	1550	—	—	
	MINUTES	120	110	100	90	90	80	60	60	100	60	80	—	—	
INSULATION	BODY (TOTAL THICKNESS IN INCHES)	3-1/8	2-1/2	1-7/8	1-7/8	1-7/8	1-1/2	1	1	1-7/8	1	1-1/2	—	—	
	CEILING (TOTAL THICKNESS IN INCHES)	2-1/2	2-1/2	2-1/2	1-7/8	1-7/8	2	1-1/2	1-1/2	2-1/2	1-1/2	2	—	—	
	DOOR (TOTAL THICKNESS IN INCHES)	2-3/8	2-3/8	2-3/8	1-3/4	1-3/4	1-1/2	1	1	2-3/8	1	1-1/2	1-1/2	1-1/2	
STORAGE															
DOOR	DPX	•	•	•	•	•	•	1/2	•	•	•	•	—	—	
	QUICK ACCESS DOOR RACK	•	•	•	•	•	•	•	—	•	•	•	—	—	
	SCOPE SAVER	•	•	•	•	•	—	—	—	•	—	•	—	—	
HANDGUN POUCHES	TOTAL	2	2	2	2	2	2	—	—	2	2	2	—	—	
INTERIOR	AXIS ADJUSTABLE SHELVING	•	•	•	•	•	—	—	—	•	—	—	—	—	
	CANTILEVERED MODULAR SHELVING	—	—	—	—	—	•	•	—	—	•	•	—	—	
	TWO SHELVES	—	—	—	—	—	—	—	•	—	—	—	—	—	
ADDITIONAL	AXIS DRAWER	•	—	—	—	—	—	—	—	—	—	—	—	—	
	MULTIPURPOSE INSERT	•	—	—	—	—	—	—	—	—	—	—	—	—	
	PISTOL RACK (5 GUN)	•	•	•	•	•	—	—	—	•	—	—	—	—	
APPEARANCE															
COLORS	TWO-TONE STEEL DAWN	•	•	•	—	—	—	—	—	—	—	—	—	—	
	TWO-TONE DESERT SMOKE	•	•	•	—	—	—	—	—	—	—	—	—	—	
	TWO-TONE CRIMSON FADE	•	•	•	—	—	—	—	—	—	—	—	—	—	
	GLOSS BLACK	•	•	•	•	•	•	•	•	•	•	•	•	•	
	GLOSS BLACK CHERRY	•	•	•	—	—	—	—	—	—	—	—	•	•	
	GLOSS HUNTER GREEN METALLIC	•	•	•	—	—	—	—	—	—	—	—	•	•	
	GLOSS CHARCOAL METALLIC	•	•	•	—	—	—	—	—	—	—	—	•	•	
	GLOSS TITANIUM METALLIC	•	•	•	—	—	—	—	—	—	—	—	•	•	
	MATTE BLACK	•	•	•	—	—	—	—	—	—	•	•	—	•	
	TEXTURED CHARCOAL	—	•	•	•	•	•	•	—	—	—	—	—	•	
	HAMMER GRAY	—	—	—	—	—	—	—	•	—	—	—	—	—	
	PRIMER BLACK	—	—	—	—	—	—	—	—	—	—	—	—	•	
WHITE PRIMER	—	—	—	—	—	—	—	—	—	—	—	—	•		
INTERIOR COVERING	GRADE VI CEDAR	•	—	—	—	—	—	—	—	—	—	—	—	—	
	BEIGE FABRIC	—	•	•	•	•	•	•	•	•	•	•	—	—	
HANDLE TYPE & FINISH	5-SPOKE CHROME	•	•	•	—	—	—	—	—	—	—	—	•	•	
	5-SPOKE GOLD	•	•	•	—	—	—	—	•	—	—	—	•	•	
	5-SPOKE BLACK CHROME	•	•	•	—	—	—	—	—	—	—	—	•	•	
	3-SPOKE CHROME	—	—	—	•	—	—	•	—	—	—	—	—	—	
	3-SPOKE GOLD	—	—	—	—	—	—	—	—	—	—	—	•	•	
	3-SPOKE BLACK CHROME	—	—	—	—	•	•	—	—	—	—	—	—	—	
	TACTICAL BLACK CHROME	—	—	—	—	—	—	—	—	•	•	—	—	—	
	RESIDENTIAL BRASS	—	—	—	—	—	—	—	—	—	—	—	—	•	
GRAPHICS	BUCKMARK	•	•	•	—	—	—	—	—	—	—	—	•	•	
	ELK	•	•	•	—	—	—	—	—	—	—	—	•	•	
	MULE DEER	•	•	•	—	—	—	—	—	—	—	—	•	•	
	WHITETAIL BUCK/DOE	•	•	•	—	—	—	—	—	—	—	—	•	•	
	POINTER	•	•	•	—	—	—	—	—	—	—	—	•	•	
	MALLARDS	•	•	•	—	—	—	—	—	—	—	—	•	•	
	MOUNTAIN	•	•	•	—	—	—	—	—	—	—	—	•	•	
	SCROLL	•	•	•	•	—	•	•	—	—	—	—	•	•	
	DUCKS UNLIMITED	•	•	•	—	—	—	—	—	—	—	—	•	•	
	DUCKS UNLIMITED LOGO	•	•	•	—	—	—	—	—	—	—	—	•	•	
	NRA	•	•	•	—	—	—	—	—	—	—	—	•	•	
	RMEF	•	•	•	—	—	—	—	—	—	—	—	•	•	
	NWTF	•	•	•	—	—	—	—	—	—	—	—	•	•	
NO SCENE	•	•	•	•	—	—	—	—	—	—	—	•	•		

• AVAILABLE •• SP23 & SP33 ONLY — NOT AVAILABLE/DOES NOT APPLY







A

JOHN M. BROWNING SIGNATURE LEATHER

SHELL Solid wood frame • Top grain Crazy Horse distressed leather cover with top grain aniline dyed latigo leather trim • John M. Browning signature patch • Leather security straps with brass buckles
PADDING TYPE Wool-lined interior with removable support blocks to adjust fit **HINGES** Three solid brass
LATCH Two brass combination locks **SPECIAL FEATURES** Molded thick leather full grip handle and leather corner accents • Accessory compartment with magnetized choke tube holders (will not hold titanium choke tubes) • Leather luggage tag • Firearms and accessories shown not included

CRAZY HORSE DISTRESSED LEATHER

SHELL Solid wood frame covered with durable Crazy Horse distressed leather **PADDING TYPE** Plush wool interior with removable support blocks to adjust fit **HINGE** Three solid brass **LATCH** Two brass combination locks **SPECIAL FEATURES** Thick leather handle and leather end caps • Accessory compartment with six choke tube slots • Firearms and accessories shown not included



B

NEW



C

CATLEMEN

SHELL Solid wood frame • Top grain Crazy Horse distressed leather end patch • Contrasting genuine soft suede covering • Crazy Horse distressed leather security strap with brass buckle
PADDING TYPE Wool-lined interior with removable support blocks to adjust fit • New 3-D divider design maximizes interior storage space **HINGES** Continuous leather hinge **LATCH** Two brass combination locks **SPECIAL FEATURES** Sewn leather full grip handle • Accessory compartments with four elastic choke tube holders • Two snap cap recesses • Interior hook and loop sewn and padded strap secures receiver to prevent movement • Firearms and accessories shown not included

HIGH GRADE CANVAS UNIVERSAL

SHELL Solid wood frame • Canvas covered with heavy high-grade leather on borders, handle and fastening straps **PADDING TYPE** Soft wool lining **HINGES** Three solid brass **LATCH** Two solid brass combination locks **SPECIAL FEATURES** Polished brass fittings • Buckmark logo stamped on leather patches on the inside and outside • Leather trim • Accessory compartment • Firearms and accessories shown not included



D



E

LEATHER/CANVAS UNIVERSAL

SHELL Solid wood frame • Canvas covered • Full-grain reinforced leather trim **PADDING TYPE** Soft wool lining with movable padded support blocks **HINGES** Three solid brass **LATCH** Two brass combination locks and adjustable leather straps **SPECIAL FEATURES** Embroidered Browning logo inside lid • Firearms and accessories shown not included
DOES NOT FIT BT-100



NEW

CHESAPEAKE

SHELL Solid wood frame • Black vinyl cover with alligator-pattern brown vinyl trim on borders and handle
PADDING TYPE Soft wool lining • Elastic retainers for four choke tubes • Compartment for shooting glasses and gloves
HINGES Three solid brass **LATCH** Two solid brass latches **SPECIAL FEATURES** Polished brass fittings • Buckmark logo stamped on oval brass plaque on the outside • Firearms and accessories shown not included

CANVAS OVER/UNDER

SHELL Solid wood frame covered with canvas **PADDING TYPE** Soft wool lining **HINGES** Three brass **LATCH** Two brass combination locks **SPECIAL FEATURES** Leather corner accents • Thick leather handle • Firearms and accessories shown not included **DOES NOT FIT CITORI XS SKEET OR TRAP**



NEW

PIEDMONT

SHELL Solid wood frame with cotton canvas covering and synthetic leather end patch • Contrasting 3D embroidered Buckmark **PADDING TYPE** Wool-lined interior with removable support blocks to adjust fit • New 3-D divider design maximizes interior storage space **HINGE** Full-length sewn **LATCH** Two combination locks **SPECIAL FEATURES** Interior hook and loop tie-down strap • Firearms and accessories shown not included



NEW

ENCINO II

SHELL Solid wood frame • Black pebble-grained simulated leather covered with contrasting brown simulated leather on ends and bottom **PADDING TYPE** Soft synthetic suede lining **HINGES** Three solid brass **LATCH** Two solid brass combination locks **SPECIAL FEATURES** Polished brass fittings • Accessory compartment • Firearms and accessories shown not included

NEW 2015	DESCRIPTION	CODE NUMBER	SUGGESTED RETAIL	DIMENSIONS Inches	STOCK/RECEIVER CAPACITY	BARREL CAPACITY	HOLDS BT STYLE GUNS	HOLDS OVER/UNDER STYLE GUNS	HOLDS AUTO/PUMP STYLE GUNS	HOLDS GUNS WITH EXTENDED CHOKE TUBES INSTALLED Maximum Inches	RIFLE CASE	MAXIMUM BARREL LENGTH Inches
A	JOHN M. BROWNING SIGNATURE LEATHER											
	Leather/Brown	1428798208	810.00	35-1/4 x 10 x 4-1/2	1	1	Y	Y	N	32 +	-	32
B	CRAZY HORSE DISTRESSED LEATHER											
	Brown	1424208408	785.00	36-7/8 x 10-5/8 x 4	1	1	Y	Y	N	34 +	-	34
C	CATTLEMEN											
	Leather/Brown Suede	1428328212	600.00	33-7/8 x 8-3/4 x 3-1/2	1	1	Y	Y	N	32 +	-	32
D	HIGH GRADE CANVAS UNIVERSAL											
	Sage/Tan	1424504408	535.00	36-7/8 x 10-5/8 x 4	1	1	Y	Y	N	34 +	-	34
E	LEATHER/CANVAS UNIVERSAL											
	Charcoal/Brown	1426129408	460.00	36-3/4 x 10-1/2 x 4-3/4	1	1	Y	Y	N	34 +	-	34
F	CHESAPEAKE											
	Black/Brown	1427049408	400.00	35-3/4 x 9-3/4 x 2-3/4	1	1	Y	Y	N	34 +	-	34
G	CANVAS OVER/UNDER											
	Green/Olive	142510	350.00	34-3/8 x 9-5/8 x 3-11/16	1	1	N	Y	N	-	-	32
H	PIEDMONT											
	Clay/Brown	1428338212	275.00	33-7/8 x 8-3/4 x 3-1/2	1	1	Y	Y	N	32 +	-	32
I	ENCINO II											
	Black/Brown	1425039212	275.00	33-7/8 x 8-3/4 x 3-1/2	1	1	Y	Y	N	32 +	-	32

TRADITIONAL, TASTEFUL PROTECTION FOR EVERY CLASSIC BROWNING.

Nothing speaks more eloquently of one's good taste than a traditional Browning fitted case constructed of solid wood with brass fittings and the look of aged leather. They create the perfect backdrop for showing off a fine Browning firearm. These fitted gun cases provide a place for everything from choke tubes to shooting gloves and are designed to provide decades of tasteful protection for the valuable Browning within.



A



B

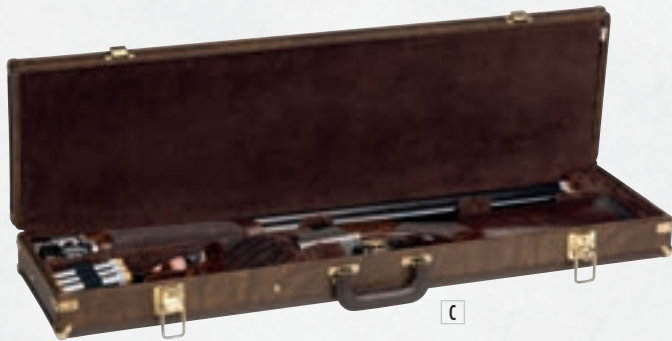

C



D



CLASSIC BROWN



BLACK/TAN

TRADITIONAL

SHELL Rugged wood construction covered with expanded vinyl **PADDING TYPE** Deep pile fleece with fabric-covered positioning blocks **HINGES** Three brass-plated **LATCH** One or two key locks **SPECIAL FEATURES** Brass corner accents • Folding molded handle • Accessory compartment • Firearms and accessories shown not included ***DOES NOT FIT CITORI TRAP OR SKEET**

DESCRIPTION	CODE NUMBER	SUGGESTED RETAIL	COLOR	DIMENSIONS Inches	STOCK/RECEIVER CAPACITY	BARREL CAPACITY	HOLDS BT STYLE GUNS	HOLDS OVER/UNDER STYLE GUNS	HOLDS AUTO/PUMP STYLE GUNS	HOLDS GUNS WITH EXTENDED CHOKE TUBES INSTALLED Maximum Inches	RIFLE CASE	MAXIMUM BARREL LENGTH Inches
A BT-Style Single Barrel Trap	142810	360.00	Classic Brown	35-1/2 x 8-1/4 x 3-3/4	1	1	Y	N	N	—	N	34
BT-Style Single Barrel	1428119410	365.00	Black/Tan	35-1/2 x 8-3/4 x 3-3/4	1	1	Y	N	N	—	N	34
B Auto/Pump Shotgun	142821	415.00	Classic Brown	35-1/2 x 10-1/2 x 3-3/4	1	2	N	N	Y	—	N	32
C Universal Over/Under, BT Trap	1428118408	375.00	Classic Brown	35-1/2 x 9 x 3-1/2	1	1	Y	Y	N	34 +	N	34
Universal Over/Under, BT Trap	1428119408	375.00	Black/Tan	35-1/2 x 9 x 3-1/2	1	1	Y	Y	N	34 +	N	34
Over/Under Shotgun*	142841	350.00	Classic Brown	33 x 8-5/8 x 3	1	1	N	Y	N	—	N	32
Over/Under Shotgun*	142840	325.00	Classic Brown	31 x 8-5/8 x 3	1	1	N	Y	N	—	N	30
Over/Under Shotgun for Citori Trap or Skeet	142880	390.00	Classic Brown	33-1/4 x 8-3/4 x 4-1/8	1	1	N	Y	N	—	N	32
Over/Under with Extra Barrel	142850	390.00	Classic Brown	31 x 10-1/8 x 3-3/4	1	2	N	Y	N	—	N	30
Two Gun	142890	525.00	Classic Brown	36 x 8-1/4 x 5-3/8	2	2	N	Y	N	—	N	34
D Browning SA-22 Rifle	1428608090	375.00	Black/Tan	27-1/4 x 9 x 3-1/4	1	1	N	N	N	—	Y	—





TALON DOUBLE GUN

SHELL Anodized aluminum frame • Diamond pattern ABS cover over composite panels
PADDING TYPE High-density convoluted foam **CLOSURE** Combination and key locks
SPECIAL FEATURES Wheels make transportation easier • Embossed metal Buckmark plaque • Lightweight • Straps hold firearms • Firearms and accessories shown not included

CODE NUMBER	SUGGESTED RETAIL	DIMENSIONS Inches	WEIGHT Lbs.
1460079999	400.00	53 x 16 x 5	17

TALON TAKE DOWN

SHELL Anodized aluminum frame • Diamond pattern ABS cover over composite panels
PADDING TYPE High-density convoluted foam **CLOSURE** Combination and key locks
SPECIAL FEATURES Wheels make transportation easier • Embossed metal Buckmark plaque • Lightweight • Straps hold firearms • Firearms and accessories shown not included

CODE NUMBER	SUGGESTED RETAIL	DIMENSIONS Inches	WEIGHT Lbs.
1460079512	210.00	35-1/2 x 10-1/2 x 4	9



TALON DOUBLE PISTOL

SHELL Anodized aluminum frame • Diamond pattern ABS cover over composite panels
PADDING TYPE High-density convoluted foam **CLOSURE** Combination locks
SPECIAL FEATURES Embossed metal Buckmark plaque • Lightweight • Sturdy carry handle • Firearms and accessories shown not included

CODE NUMBER	SUGGESTED RETAIL	DIMENSIONS Inches	WEIGHT Lbs.
1460079866	115.00	13-1/2 x 12 x 3-3/4	4.3

TALON AMMO CASE

SHELL Anodized aluminum frame • Diamond pattern ABS cover over composite panels
PADDING TYPE High-density convoluted foam **CLOSURE** Key locks
SPECIAL FEATURES Embossed metal Buckmark plaque • Lightweight • Carry handle • Shoulder strap • Ammunition shown not included

CODE NUMBER	SUGGESTED RETAIL	DIMENSIONS Inches	WEIGHT Lbs.
12100798	115.00	15-1/2 x 6 x 6	4.7



NEW

NEW



BRUISER PRO

SHELL Double wall high-density polyethylene with diamond plate texture **PADDING TYPE** High-density foam with extendable foam insert barriers **HINGE** Tough Lock™ **LATCH** Three locking points for user supplied padlocks **SPECIAL FEATURES** Rounded corners • Recessed handles • Equalization air valve • O-ring seal on tongue and groove lid for added protection • Recessed wheels • Zerust inserts • Airline approved • Firearms and accessories shown not included

Zerust®

	DESCRIPTION	CODE NUMBER	SUGGESTED RETAIL	DIMENSIONS Inches	WEIGHT Lbs.
A	Take Down	1492001	270.00	38 x 14 x 5	14
B	Double Gun	1492002	330.00	54 x 15 x 5	19



MIRAGE

SHELL Copolymer **PADDING TYPE** Double convoluted foam **HINGE** Piano-style **LATCH** Four locking points **SPECIAL FEATURES** Single gun holds one scoped firearm • Oversize double case holds two scoped firearms • Airline approved • Corrosion-inhibiting Zerust® inserts

	DESCRIPTION	CODE NUMBER	SUGGESTED RETAIL	DIMENSIONS Inches	WEIGHT Lbs.
A	Single Gun	1470022	72.00	53-5/8 x 12-1/8 x 3-3/4	5
B	Double Gun	1470021	110.00	53-3/8 x 16-1/2 x 4-1/2	12

Zerust®

SPORTER

SHELL Solid wood frame with PVC-coated exterior **PADDING TYPE** High-density convoluted foam **HINGE** Full-length leather **LATCH** Two combination locks **SPECIAL FEATURES** Interior tie-down straps • Firearms and accessories shown not included

CODE NUMBER	SUGGESTED RETAIL	DIMENSIONS Inches	WEIGHT Lbs.
1422109408	310.00	36-1/4 x 11 x 3-3/4	6





PURE BUCKMARK

SHELL Polyester canvas **LINING** Brushed tricot **PADDING TYPE** Open/closed-cell foam **CLOSURE** Zipper **TRIM AND BINDING** Contrasting polyester webbing • Screenprinted Buckmark

DESCRIPTION	COLOR/PATTERN	LENGTH Inches	CODE NUMBER	SUGGESTED RETAIL
A Scoped, For Her	Black/Fuchsia	48	1410029148	38.00
B Regular, For Her	Black/Fuchsia	52	1410029252	38.00
C Slip, Scoped	Black/Gold	48	1410099048	38.00
D Slip, Regular	Black/Gold	52	1410019052	38.00
E Scoped	Black/Gold	40	1410019140	38.00
F Scoped	Black/Gold	48	1410019148	38.00
F Regular	Black/Gold	52	1410019252	38.00



SANTA FE

SHELL Waxed 10 oz. cotton canvas **LINING** Quilted flannel **PADDING TYPE** Cotton batting **MUZZLE CAP** Leather **TRIM AND BINDING** Crazy Horse leather • Adjustable leather strap • Side pocket with choke tube loops on 52" model, cartridge loops on 48" model • Hook and loop closure

DESCRIPTION	COLOR/PATTERN	LENGTH Inches	CODE NUMBER	SUGGESTED RETAIL
A Scoped	Tan	48	1419908248	275.00
B Regular	Tan	52	1419908152	265.00



CIMMARON

SHELL 600 denier polyester canvas **LINING** Brushed tricot **PADDING TYPE** Open/closed-cell foam **CLOSURE** Zipper
TRIM AND BINDING Polyester canvas • For Her models feature pink trim and 3D embroidered Buckmark
SPECIAL FEATURES Outside pocket for choke tubes on 52" model • Pocket with cartridge loops on 48" model
MUZZLE CAP Leather • Firearms and accessories shown not included

	DESCRIPTION	COLOR/PATTERN	LENGTH Inches	CODE NUMBER	SUGGESTED RETAIL
A	Scoped, For Her	Black/Tan/Pink	48	1410309348	58.00
B	Regular, For Her	Black/Tan/Pink	52	1410309352	58.00
C	Scoped	Black/MOINF	48	1410300248	70.00
D	Regular	Black/MOINF	52	1410300152	70.00
	Scoped	Black/Tan	40	1410309240	55.00
	Scoped	Black/Tan	44	1410309244	58.00
E	Scoped	Black/Tan	48	1410309248	58.00
F	Regular	Black/Tan	52	1410309152	58.00
G	BLR Takedown	Black/Tan	N/A	1410309090	75.00



FORTRESS

SHELL Heavy 1680 denier ballistic polyester **LINING** Plush brushed tricot **PADDING TYPE** High-density closed-cell foam **CLOSURE** Full-length, heavy-duty zipper with pull tab allows the case to lay flat when open **MUZZLE CAP** Simulated black leather **TRIM AND BINDING** Simulated black leather • Black web handles **SPECIAL FEATURES** Embroidered 3D Buckmark • 48" rifle model and 52" shotgun model

	DESCRIPTION	COLOR/PATTERN	LENGTH Inches	CODE NUMBER	SUGGESTED RETAIL
A	Scoped	Brown/Black	48	1410088148	70.00
B	Regular	Brown/Black	52	1410088252	70.00



PLAINSMAN

SHELL 600 denier polyester canvas **LINING** Brushed tricot
PADDING TYPE Open-cell foam **CLOSURE** Zipper
TRIM AND BINDING Polyester canvas

	NEW 2015	DESCRIPTION	COLOR/PATTERN	LENGTH Inches	CODE NUMBER	SUGGESTED RETAIL
A		Scoped	RTX	48	1410042448	55.00
		Regular	RTX	52	1410042452	55.00
		Slip	RTX	52	1410042152	50.00
		Scoped	Black	40	1410049240	40.00
		Scoped	Black	44	1410049244	40.00
B		Scoped	Black	48	1410049248	40.00
		Slip	Black	52	1410049052	38.00
		Regular	Black	52	1410049152	40.00
C		• Regular	MOBUC	52	1410028152	55.00
		• Scoped	MOBUC	48	1410028248	55.00
		• Slip	MOBUC	52	1410028052	50.00

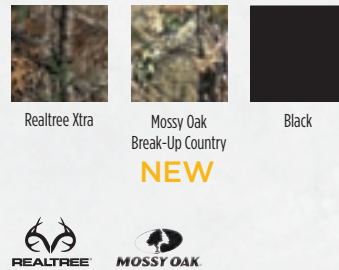

DESCRIPTION	LENGTH Inches	CODE NUMBER	SUGGESTED RETAIL
Black	50	1410079250	75.00

TALON

SHELL 600 denier poly canvas **LINING** Brushed tricot
PADDING TYPE Open- and closed-cell foam **CLOSURE** Zipper
TRIM AND BINDING Polyester canvas **SPECIAL FEATURES** 3D Buckmark embroidery • Oversize design fits large optics and bipods
 • Two zipper closure pockets



HIDALGO

SHELL 600 and 1200 denier polyester canvas **LINING** Brushed tricot lining
PADDING TYPE Closed-cell foam **CLOSURE** Zipper **MUZZLE CAP** Simulated leather
TRIM AND BINDING Polyester **SPECIAL FEATURES** Embroidered Buckmark
 • Side pocket with choke tube loops on 52" model • Shell loops on 48" model • Hook and loop closure

	DESCRIPTION	COLOR/PATTERN	LENGTH Inches	CODE NUMBER	SUGGESTED RETAIL
A	Scoped	Black/Clay	48	1410418248	58.00
B	Regular	Black/Clay	52	1410418152	58.00



DIRTY BIRD FLOATER

SHELL Polyester canvas **LINING** Nylon tricot **PADDING TYPE** High-density closed-cell foam
CLOSURE Zipper side closure allows easy drying • Hook and loop flap **TRIM AND BINDING** Tan webbing and accents with Dirty Bird embroidery **SPECIAL FEATURES** Side pocket • EVA foam muzzle cap with Buckmark • Hanging loop

	DESCRIPTION	LENGTH Inches	CODE NUMBER	SUGGESTED RETAIL
A	MOSGB	52	1410532552	58.00
B	RTM5	52	1410537652	58.00

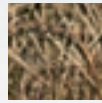

Mossy Oak Shadow Grass Blades

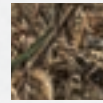

Realtree Max-5

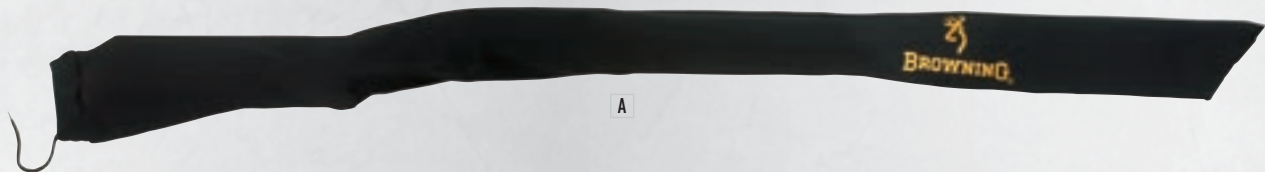

VCI GUN SOCK

VCI (Vapor Corrosion Inhibitor) penetrates into the smallest crevices and drives out moisture where oils cannot reach • Provides full protection by forming a vapor enclosure around the firearm from muzzle to butt • Gives additional protection to all metal items in an enclosed area such as a gun safe or cabinet • One- or two-piece models to fit most firearms • Drawstring closure • Fits rifles and shotguns 48" to 56" • Firearms shown not included

	DESCRIPTION	CODE NUMBER	SUGGESTED RETAIL
A	One-Piece	149985	18.00
B	Two-Piece	149986	22.00



NEOPRENE GUN JACKET

Waterproof • Rugged stretchable neoprene material protects fine guns and optics from the elements and bumps during transportation • Designed to quickly insert and remove firearms • Folds for storage • Firearms and accessories shown not included

DESCRIPTION	COLOR/PATTERN	CODE NUMBER	SUGGESTED RETAIL
Shotgun	Black	12974299	76.00
Shotgun	RTM4	12974222	76.00
Rifle	Black	12974199	76.00
Rifle	RTX	12974124	76.00

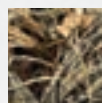

Realtree Max-4

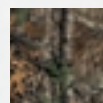

Realtree Xtra



Black



NEW



CROSSFIRE DOUBLE PISTOL CASE

SHELL Heavy 600 denier polyester **LINING** Nylon fabric with two offset padded pockets to protect standard size pistols **PADDING TYPE** Closed-cell foam **CLOSURE** Double pull zippers with nylon pull tabs **TRIM AND BINDING** Polyester and nylon • Fully-bound sewn edges **SPECIAL FEATURES** Two large zippered side pockets, one with five magazine storage slots, the other with three ammo box and accessory slots • Two mesh exterior pockets with hook and loop closures for documents and smaller flat items • Nylon web carry handles • Firearms shown not included

DESCRIPTION	LENGTH Inches	CODE NUMBER	SUGGESTED RETAIL
Black/Gray	13	12902099	54.00



FLEX FOAM CASE

SHELL 600 denier polyester **LINING** Soft laminated nylon tricot **PADDING TYPE** Form-fitting EVA foam **CLOSURE** Zipper **TRIM AND BINDING** Polyester and nylon • D-rings for attaching shoulder strap (not included) **SPECIAL FEATURES** Magazine storage • Nylon carry straps • Firearms and accessories shown not included

DESCRIPTION	LENGTH Inches	CODE NUMBER	SUGGESTED RETAIL
Black	15	1419001	70.00



JOHN M. BROWNING BIOGRAPHY

The essential biography detailing the life and inventions of the greatest firearms inventor the world has ever known • Includes detailed original patent drawings and photographs • Hardcover • 390 pages

CODE NUMBER	SUGGESTED RETAIL
12980	38.00



SANTA FE PISTOL RUG

SHELL Cotton canvas **LINING** Nylon tricot **PADDING TYPE** Cotton batting **CLOSURE** Zipper **TRIM AND BINDING** Polyester nylon **SPECIAL FEATURES** D-ring for attaching shoulder strap or so case can be locked (lock not included)

DESCRIPTION	LENGTH Inches	CODE NUMBER	SUGGESTED RETAIL
Tan	11	143990811	63.00

PURE BUCKMARK PISTOL RUG

SHELL Polyester canvas **LINING** Brushed tricot **PADDING TYPE** Open/closed-cell foam **CLOSURE** Zipper **TRIM AND BINDING** Contrasting polyester webbing

	DESCRIPTION	LENGTH Inches	CODE NUMBER	SUGGESTED RETAIL
A	Black/Yellow	13	143003913	20.00
B	Black/Fuchsia, For Her	9	143002909	20.00



NEW FOR HER MODEL



PLAINSMAN PISTOL RUG

SHELL Polyester canvas **LINING** Nylon tricot **PADDING TYPE** Open-cell foam **CLOSURE** Zipper **TRIM AND BINDING** Polyester nylon **SPECIAL FEATURES** D-ring for attaching shoulder strap or so case can be locked (lock not included)

	NEW 2015	DESCRIPTION	LENGTH Inches	CODE NUMBER	SUGGESTED RETAIL
A		Black	13	1430049813	20.00
		Black	11	1430049811	19.00
		RTX	13	1430042413	23.00
B	•	MOBUC	13	1410028813	23.00

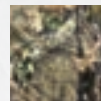

Mossy Oak Break-Up Country

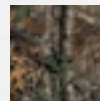

Realtree Xtra



Black



NEW

FORTRESS PISTOL RUG

SHELL Polyester canvas **LINING** Nylon tricot **PADDING TYPE** Closed-cell foam **CLOSURE** Zipper **TRIM AND BINDING** Polyester nylon **SPECIAL FEATURES** D-ring for attaching shoulder strap or so case can be locked (lock not included)

DESCRIPTION	LENGTH Inches	CODE NUMBER	SUGGESTED RETAIL
Black/Brown	13	143008813	24.00



CIMMARON PISTOL RUG

SHELL Polyester canvas **LINING** Brushed tricot **PADDING TYPE** Open/closed-cell foam **CLOSURE** Zipper **TRIM AND BINDING** Polyester nylon **SPECIAL FEATURES** D-ring for attaching shoulder strap or so case can be locked (lock not included)

	DESCRIPTION	LENGTH Inches	CODE NUMBER	SUGGESTED RETAIL
A	Black/Taupe	13	143030913	22.00
	Black/Taupe	11	143030911	21.00
B	Black/Pink, For Her	11	1430309311	21.00

HIDALGO PISTOL RUG

SHELL Polyester canvas **LINING** Nylon tricot **PADDING TYPE** Closed-cell foam **CLOSURE** Zipper **TRIM AND BINDING** Polyester nylon **SPECIAL FEATURES** D-ring for attaching shoulder strap or so case can be locked (lock not included)

DESCRIPTION	LENGTH Inches	CODE NUMBER	SUGGESTED RETAIL
Black/Clay	13	1430418813	22.00
Black/Clay	11	1430418811	20.00





NEW

A

CATLEMEN RANGE BAG

Constructed with nylon canvas lining, brown suede body and Crazy Horse distressed leather trim • Foam padded sides maintain bag shape • Large compartmentalized interior holds 16 boxes of shells and allows separation of shell gauges • Sturdy zippers • Four exterior accessory pockets • Comfortable padded nylon web shoulder strap and sewn leather handles • Attractive antique brass hardware • 15" W x 10-1/2" H x 13" D

	CODE NUMBER	SUGGESTED RETAIL
A	121080081	365.00



B

NEW

CATLEMEN SHELL POUCH

Constructed with herringbone twill lining, brown suede body and Crazy Horse distressed leather trim • Adjustable nylon web belt with leather trim and heavy duty brass roller buckle • 9" W x 12-1/2" H x 3" D

	CODE NUMBER	SUGGESTED RETAIL
B	121080082	120.00



C

CATLEMEN SHELL CARRIER

Constructed with herringbone twill lining, brown suede body and Crazy Horse distressed leather trim • Leather covered metal clip attaches to belt • 5-1/4" W x 5-1/2" H x 3" D

	CODE NUMBER	SUGGESTED RETAIL
C	121080084	57.00



D

SANTA FE SHOOTING BAG

Constructed from 10 oz. waxed cotton canvas with Crazy Horse distressed leather trim • Foam padded sides maintain bag shape • Large compartmentalized interior holds 16 boxes of shells and allows separation of shell gauges • Sturdy zippers • Four exterior accessory pockets • Comfortable padded leather shoulder strap and handles • Attractive brass hardware • 12" W x 10" H x 9" D

	CODE NUMBER	SUGGESTED RETAIL
D	121040081	275.00



E

SANTA FE SHELL POUCH

Constructed from 10 oz. waxed cotton canvas with Crazy Horse distressed leather trim • Large empty hull pouch • Shell box holder with three choke tubes/shell loops • Adjustable belt with quick release buckle • 9" W x 15" H x 5" D • Ammunition shown not included

	CODE NUMBER	SUGGESTED RETAIL
E	121040082	115.00



F

SANTA FE SHELL CARRIER

Constructed from 10 oz. waxed cotton canvas with Crazy Horse distressed leather trim • Metal clip attaches to belt • 5-1/4" W x 5-1/2" H x 3" D • Ammunition shown not included

	CODE NUMBER	SUGGESTED RETAIL
F	121040084	38.00



G

FORTRESS SHOOTING BAG

1680 denier polyester canvas shell • Large padded main compartment with bound seams • Zippered exterior accessory pocket • Large upper accessory pocket for binoculars or small spotting scope • Two-way zippers • Black synthetic leather end trim • Comfortable web carry handles and adjustable shoulder strap • Interior divider • 15" W x 7" H x 9" D

	CODE NUMBER	SUGGESTED RETAIL
G	121008891	65.00



H

FORTRESS SHELL POUCH

1680 denier polyester canvas shell • Large divided main compartment • Black synthetic leather trim • Adjustable belt with quick release buckle • 9" W x 9" H x 4" D

	CODE NUMBER	SUGGESTED RETAIL
H	121008892	35.00



NEW FOR HER MODEL

PURE BUCKMARK SHOOTING BAG

600 denier polyester shell • Padded interior for rigid shape • Five exterior accessory pockets • Comfortable contrasting padded handles and shoulder strap • Interior divider • For Her model has pink trim and Buckmark • 11" W x 9" H x 8" D • Accessories shown not included

	DESCRIPTION	CODE NUMBER	SUGGESTED RETAIL
A	Shooting Bag	121021991	80.00
B	Shooting Bag For Her	121002991	80.00



NEW FOR HER MODEL



PURE BUCKMARK SHELL POUCHES

600 denier polyester shell • Large double compartment design • Shell box holder with four choke tube/shell loops • Contrasting webbing • Adjustable belt with quick release buckle • For Her model has pink trim and Buckmark • Ammunition shown not included

	DESCRIPTION	DIMENSIONS	CODE NUMBER	SUGGESTED RETAIL
A	Short	9" W x 12" H x 4-1/2" D	121021992	30.00
B	Short For Her	9" W x 12" H x 4-1/2" D	121002992	30.00
C	Long	9" W x 15" H x 4-1/2" D	121021993	35.00



PURE BUCKMARK SHELL BOX CARRIER

Metal clip attaches to belt • Contrasting webbing • Buckmark imprint • 5-1/4" W x 5-1/2" H x 3" D • Ammunition shown not included

CODE NUMBER	SUGGESTED RETAIL
121021994	15.00

PURE BUCKMARK EMPTY SHELL CARRIER

Attaches to belt • Mesh pouch • Contrasting webbing • Buckmark imprint • 10" W x 20" H x 4" D

CODE NUMBER	SUGGESTED RETAIL
121021995	20.00



NEW



CROSSFIRE MODULAR RANGE BAGS

600 denier polyester shell • Full-length semi-rigid interior divider • Padded interior with hook and loop panels allow user to configure interior to specific storage needs • Internal mesh document pocket • Two large exterior accessory pockets on sides • Fold-out removable plush surfaced gun cleaning mat • End pocket is sized for holding hearing protection • Two end pockets are sized for ammo boxes • Comfortable padded carry handles • Rubber-clad double pull strap • Large model (shown) is 23" W x 10" H x 14" D and includes two modular internal pistol holders, one magazine holder, one mesh brass bag, one ammo pocket and one eyewear/accessory pouch • Small model is 19" W x 13" H x 9" D and includes one modular internal pistol holder, one magazine holder, one mesh brass bag and one eyewear/accessory pouch • Firearms, ammunition and accessories shown not included

DESCRIPTION	CODE NUMBER	SUGGESTED RETAIL
(SHOWN IN LARGE)		
Small	121070018	138.00
Large	121070024	160.00

HIDALGO RANGE BAG

600 and 1200 denier polyester canvas • Large oversized main body holds 10 shell boxes plus gear • Three large double-zip accessory pockets • Two large single zip accessory pockets • Gate mouth keeps bag open for easy access • Comfortable padded handles and shoulder strap • Lockable zipper closures on main compartment • 18" W x 12-1/2" H x 11" D

CODE NUMBER	SUGGESTED RETAIL
121041891	82.00



HIDALGO SHELL CARRIERS

ONE BOX Holds one box of shotgun shells for instant access • Metal clip attaches to belt • 5-1/4" W x 5-1/2" H x 3" D **SIX BOX** Accessory pockets • Sturdy web handles • 7" W x 9" H x 5" D (excluding exterior pockets) • Ammunition and accessories shown not included

	DESCRIPTION	CODE NUMBER	SUGGESTED RETAIL
A	One Box	121041894	13.00
B	Six Box	121041895	23.00

HIDALGO SHELL POUCH

600 and 1200 denier polyester canvas • Large double compartment • Adjustable belt with quick release buckle • 9" W x 11" H x 4-3/4" D

CODE NUMBER	SUGGESTED RETAIL
121041893	22.00





CIMMARON SHOOTING BAGS

600 denier polyester shell • Padded interior for rigid shape • Four exterior accessory pockets • Comfortable padded handles and shoulder strap • Interior divider • For Her model has pink trim and Buckmark • 11-1/2" W x 10" H x 9" D

	DESCRIPTION	CODE NUMBER	SUGGESTED RETAIL
A	Shooting Bag	121030091	85.00
B	Shooting Bag For Her	121030391	85.00

CIMMARON RANGE BAGS

600 denier polyester canvas • Two padded pistol pockets with lockable zip closure • Main compartment has double zip opening for easy access • Adjustable padded shoulder strap • 12 elasticized interior magazine loops • For Her model has pink trim and Buckmark • 13" W x 8" H x 8-1/2" D

	DESCRIPTION	CODE NUMBER	SUGGESTED RETAIL
A	Two Pistol Range Bag	121030099	55.00
B	Two Pistol Range Bag For Her	121030399	55.00



CIMMARON SHELL POUCHES

600 denier polyester mesh pouch • Large empty hull pouch • Shell box holder with choke tube/shell loops • Adjustable belt with quick-release buckle • For Her model has pink trim and Buckmark • 9" W x 11-1/4" H x 4-3/4" D • Ammunition shown not included

	DESCRIPTION	CODE NUMBER	SUGGESTED RETAIL
A	Shell Pouch	121030093	35.00
B	Shell Pouch For Her	121030393	35.00

CIMMARON SHELL CARRIERS

ONE BOX Metal clip attaches to belt • 5-1/4" W x 5-1/2" H x 3" D
FOUR BOX Accessory pockets • Sturdy web handles • 10" W x 4-1/2" H x 5" D excluding exterior pockets • Ammunition shown not included

	DESCRIPTION	CODE NUMBER	SUGGESTED RETAIL
A	One Box	121030094	16.00
B	Four Box	121030095	22.00





X-CELLERATOR PLUS

Padded neoprene shoulder strap prevents the firearm from slipping off the shoulder • Patented slip-lock buckle is easy to adjust, even with winter gloves • Metal sling swivels are included • Ammunition shown not included

	FITS	DESCRIPTION	LENGTH	CODE NUMBER	SUGGESTED RETAIL
A	Rifles	Realtree Xtra	25-1/2 to 28	122324025	66.00
	Rifles	Black	25-1/2 to 28	122312025	66.00
	Rifles	Mossy Oak New Break-Up	25-1/2 to 28	122310125	66.00
	Rifles	Mossy Oak Break-Up Infinity	25-1/2 to 28	122300725	66.00
	Rifles	Digital Green	25-1/2 to 28	122313425	66.00
	Shotguns	Black	38 to 48	122312035	73.00
	Shotguns	Mossy Oak Duck Blind	38 to 48	122313035	73.00
B	Rifles	Mossy Oak Break-Up Infinity w/ Loops	25-1/2 to 28	122310325	80.00
	Rifles	Black w/ Loops	25-1/2 to 28	122302325	80.00

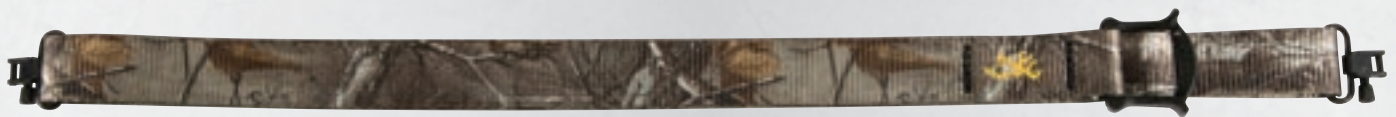

X-CELLERATOR

Patented slip-lock buckle is easy to adjust, even with winter gloves • Innovative design can be positioned as either a shoulder-style or a backpack sling • Provides a wide range of adjustment plus a generous 1-1/4" width • Metal sling swivels are included

	FITS	DESCRIPTION	LENGTH	CODE NUMBER	SUGGESTED RETAIL
(SHOWN IN REALTREE XTRA)					
A	Rifles	Realtree Xtra	25-1/2 to 28	122324125	53.00
	Rifles	Black	25-1/2 to 28	122302025	53.00
	Rifles	Tan	25-1/2 to 28	122301425	53.00
	Rifles	Mossy Oak New Break-Up	25-1/2 to 28	122300125	53.00
	Rifles	Mossy Oak Break-Up Infinity	25-1/2 to 28	122310725	53.00
	Rifles	Digital Green	25-1/2 to 28	122303425	53.00
	Shotguns	Black	29-3/4 to 48-1/4	122302029	59.00
Shotguns	Mossy Oak Duck Blind	29-3/4 to 48-1/4	122303035	59.00	



ECLIPSE

Patented slip-lock buckle is easy to adjust, even with winter gloves • Innovative design can be positioned as either a shoulder-style or a backpack sling • Provides a wide range of adjustment plus a generous 1-1/4" width • Metal sling swivels are included

	FITS	DESCRIPTION	LENGTH	CODE NUMBER	SUGGESTED RETAIL
(SHOWN IN MOSSY OAK NEW BREAK-UP)					
A	Rifles	Black	25-1/2 to 28	122320025	66.00
	Rifles	Mossy Oak New Break-Up	25-1/2 to 28	122320125	66.00

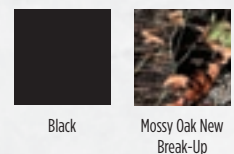

NEW



NEOPRENE

Shock-absorbing neoprene pad offers superior comfort, even with heavy firearms

- Thumb loop lets the supporting hand share part of the firearm's weight for easier carrying and less shoulder fatigue
- Rubberized pad backing is textured for a positive, non-slip grip
- Polymer ladder buckle offers easy one-hand adjustment
- Metal sling swivels are included

NEW 2015	FITS	DESCRIPTION	LENGTH	CODE NUMBER	SUGGESTED RETAIL
(SHOWN IN REALTREE MAX-5)					
•	Rifles	Big Game, Black	25-1/2 to 50	12201399	45.00
•	Rifles	Big Game, Realtree Xtra	25-1/2 to 50	12201324	45.00
•	Shotguns	Waterfowl, Mossy Oak Shadow Grass Blades	25-1/2 to 50	12201425	45.00
•	Shotguns	Waterfowl, Realtree Max-5	25-1/2 to 50	12201376	45.00



Black

Realtree Xtra

Mossy Oak Shadow Grass Blades

Realtree Max-5



FLEX GRIP

Comfortable molded rubberized pad allows for stretch when walking

- Back of pad is textured for a positive, non-slip grip
- Adjustable length
- Rifle cartridge loops
- Metal sling swivels are included

FITS	DESCRIPTION	LENGTH	CODE NUMBER	SUGGESTED RETAIL
Most Rifles	Black	25-1/2 to 41	1226799	58.00



FLEX FOAM SPORTER

Waterproof, extra-thick molded foam pad has hourglass shape to provide the ultimate in comfort, even with heavy firearms

- Back of pad is textured for a positive, non-slip grip
- Adjustable length
- Metal sling swivels are included

FITS	DESCRIPTION	LENGTH	CODE NUMBER	SUGGESTED RETAIL
(SHOWN IN MOSSY OAK NEW BREAK-UP)				
Most Rifles	Black	25-1/2 to 39	12230	31.00
Most Rifles	Mossy Oak New Break-Up	25-1/2 to 39	12231	39.00

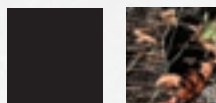

Black

Mossy Oak New Break-Up



CONTOUR CLINCHER

Quiet Dura-Touch Armor Coating helps improve grip in adverse weather conditions

- Comfortable contour fit pad profile won't slide or roll off the shoulder
- Adjustable length
- Colorfast materials resist cracking and fading
- Metal sling swivels are included

FITS	DESCRIPTION	LENGTH	CODE NUMBER	SUGGESTED RETAIL
(SHOWN IN GREEN CAMO)				
Rifles and Shotguns	Black	30 to 41-1/2	122920	58.00
Rifles and Shotguns	Green Camo	30 to 41-1/2	12294009	58.00

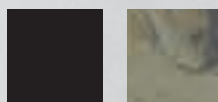

Black

Green Camo





JMB SIGNATURE SERIES **NEW**

Top grain high quality leather • Suede backing • Edge stitching • Embossed with John M. Browning's signature • Quality brass hardware • Available in black, dark brown and walnut brown • Metal sling swivels are included • Fits most rifles and shotguns

	DESCRIPTION	SWIVEL STUD DISTANCE Inches	CODE NUMBER	SUGGESTED RETAIL
A	Black	25-1/2 to 35-1/2	122399	87.00
B	Dark Brown	25-1/2 to 35-1/2	122398	87.00
C	Walnut Brown	25-1/2 to 35-1/2	122388	87.00



BIG BUCKMARK SERIES **NEW**

Top grain vegetable tanned leather • Large Buckmark embossing • Quality brass hardware • Swivels are not included • Fits most rifles and shotguns

	DESCRIPTION	SWIVEL STUD DISTANCE Inches	CODE NUMBER	SUGGESTED RETAIL
A	Black	25-1/2 to 35-1/2	122499	45.00
B	Distressed Brown	25-1/2 to 35-1/2	122488	45.00
C	Brown	25-1/2 to 35-1/2	122498	45.00



AMERICANA **NEW**

High quality top grain bison leather • Suede backing • Edge stitching • Red and blue leather insert • Buckmark patch • Sterling silver plated medallions of eagle and American flag • Made in the USA • Swivels are not included • Fits most rifles and shotguns

	SWIVEL STUD DISTANCE Inches	CODE NUMBER	SUGGESTED RETAIL
	25-1/2 to 28	122615	138.00



FREEDOM **NEW**

Multi-grain high quality leather • Suede backing • Edge stitching • Antiqued American flag appliqué • Buckmark patch • Made in the USA • Swivels are not included • Fits most rifles and shotguns

	SWIVEL STUD DISTANCE Inches	CODE NUMBER	SUGGESTED RETAIL
	25-1/2 to 28	122616	138.00



HERITAGE NEW

Hand-stained latigo leather • Suede backing • Contrasting figure-eight stitching • Buckmark patch
 • Made in the USA • Swivels are not included • Fits most rifles and shotguns

SWIVEL STUD DISTANCE Inches	CODE NUMBER	SUGGESTED RETAIL
25-1/2 to 28	122617	125.00



RANCH NEW

Aged bark-oiled Nubuck leather • Suede backing • X-welting with contrasting stitching
 • Buckmark patch • Made in the USA • Swivels are not included • Fits most rifles and shotguns

SWIVEL STUD DISTANCE Inches	CODE NUMBER	SUGGESTED RETAIL
25-1/2 to 28	122618	125.00



BUFFALO NICKEL

Full-grain leather construction with classic basketweave design and comfortable suede backing • Tapered shape provides added width at shoulder • Unique buffalo nickel overlays • Braided horsehair inlay panel • Adjustable length • Swivels are not included
 • Fits most rifles

SWIVEL STUD DISTANCE Inches	CODE NUMBER	SUGGESTED RETAIL
25-1/2 to 28	122602	105.00



BARBED WIRE

Full-grain leather construction with comfortable suede backing • Twisted leather cord provides a rustic barbed wire look that's perfect for both modern and historic rifles • Tapered shape provides added width at shoulder • Adjustable length
 • Swivels are not included • Fits most rifles

SWIVEL STUD DISTANCE Inches	CODE NUMBER	SUGGESTED RETAIL
25-1/2 to 28	122604	105.00



HORSEHAIR

Attractive muted colors and braided horsehair patterns create a stylish and comfortable sling with a rustic Old West flair • Features all-leather reinforcement and a thumb loop for all-day comfort in the field • Adjustable length • Swivels are not included • Fits most rifles and shotguns

	DESCRIPTION	SWIVEL STUD DISTANCE Inches	CODE NUMBER	SUGGESTED RETAIL
A	Timber	25 to 36-1/2	122294	110.00
B	Black	25 to 36-1/2	122299	110.00
C	Driftwood	25 to 36-1/2	122298	110.00



SIX MILE II NEW

Top grain leather construction • Classic Western stitch design in contrasting thread
 • Sliding shoulder adjustment with embossed logo • Adjustable length • Metal sling swivels are included • Fits most rifles and shotguns

SWIVEL STUD DISTANCE Inches	CODE NUMBER	SUGGESTED RETAIL
25-1/2 to 41	122431	61.00



LATIGO MILITARY

Traditional 1907-pattern US military-style sling adjusts to give support in the prone, sitting and kneeling positions • Metal sling swivels are included • Fits most rifles and shotguns

SWIVEL STUD DISTANCE Inches	CODE NUMBER	SUGGESTED RETAIL
25-1/2 to 50	12244	84.00



SANTA FE

Wide upper portion is padded for added comfort • Brass hardware • Crazy Horse distressed leather model has full-length contrasting side stitching and an oval Buckmark patch • Brown model offers top-grain, silicone-treated leather with leather ties • Embossed Buckmark logo • Adjustable length • Metal sling swivels are included on Crazy Horse model • Fits most rifles

	DESCRIPTION	SWIVEL STUD DISTANCE Inches	CODE NUMBER	SUGGESTED RETAIL
A	Crazy Horse	25-1/2 to 35-1/2	122503	66.00
B	Brown	25-1/2 to 35-1/2	12249	73.00



RIO LOBO

Classic Western spiral stitch design in contrasting thread • Sliding shoulder adjustment with embossed logo • Adjustable length • Swivels are not included • Fits most rifles
 • Cartridges shown not included

SWIVEL STUD DISTANCE Inches	CODE NUMBER	SUGGESTED RETAIL
25-1/2 to 35-1/2	12260	84.00



WESTERN STITCH

Traditional Western stitch design is sewn freehand with contrasting thread • Adjustable length • Swivels are not included • Fits most rifles

SWIVEL STUD DISTANCE Inches	CODE NUMBER	SUGGESTED RETAIL
25-1/2 to 35-1/2	1225012	68.00



ANTIQUE BASKETWEAVE

Classic embossed basketweave design with full-length contrasting side stitching • Adjustable length • Swivels are not included • Fits most rifles

SWIVEL STUD DISTANCE Inches	CODE NUMBER	SUGGESTED RETAIL
25-1/2 to 35-1/2	1225098	68.00





NEW

MOA MODULAR SHOOTING REST SET

Ballistic nylon construction • Four modular components allow the shooter to quickly configure the rest for ideal height • Polymer pellet fill in top and bottom modules allow for easy repositioning and provide a solid rest • Foam filled height adjustment modules absorb recoil and vibration • Hook and loop panels quickly lock modules together • Long V-shaped trough in top module holds rifle or shotgun forearm securely • Will not mar delicate surfaces • Web carry strap

CODE NUMBER	SUGGESTED RETAIL
129104	99.00



MOA UTILITY SHOOTING REST

Ballistic nylon construction • Rubberized top and bottom to hold both gun and bag in place while shooting • Polymer pellet fill allows for easy repositioning and provides a solid rest • Perfect for sighting-in rifles or handguns or when patterning shotguns

CODE NUMBER	SUGGESTED RETAIL
129101	53.00



MOA TWO-PIECE SHOOTING REST

Ballistic nylon construction • Rubberized top and bottom to hold both gun and bag in place while shooting • Polymer pellet fill allows for easy repositioning and provides a solid rest • D-ring and snap hook keep bags together while storing • Heel/toe design provides stable shooting platform

CODE NUMBER	SUGGESTED RETAIL
129100	66.00



MOA WINDOW MOUNT

Ballistic nylon construction • Rubberized top and bottom to hold both gun and bag in place while shooting • Polymer pellet fill allows for easy repositioning and provides a solid rest • Polymer filled wings provide a stable position in a shooting house window or over treestand frames • V-frame rest provides a solid platform to support firearm without lateral movement

CODE NUMBER	SUGGESTED RETAIL
129103	53.00



FINE TUNE FOR FULL POWER ACCURACY WITH THE BROWNING BOSS.

When trying to wring maximum accuracy out of any rifle, the two choices are try to find a factory load with acceptable accuracy, or experiment with handloads that offer improved accuracy but often at the cost of less than maximum velocity. Both are expensive and time consuming endeavors. With the Browning BOSS, demanding shooters can simply dial up maximum accuracy without sacrificing maximum velocity.

BOSS-CR ACCESSORY

The BOSS-CR accessory offers all the accuracy and tunable advantages of the original BOSS device without the muzzle brake feature. By simply replacing the original BOSS forward weight and recoil reduction components with the one-piece, non-ported BOSS-CR accessory, only the reduced recoil of the original BOSS is sacrificed. The BOSS-CR accessory is designed to fit only BAR Mark II and A-Bolt centerfire rifles previously factory-fitted with the BOSS. **GLOSS BLUED** for BAR Safari; A-Bolt models: Medallion and Gold Medallion **MATTE BLUED** for A-Bolt models: Composite Stalker, Hunter, Euro-Bolt, Varmint, Eclipse Hunter and M-1000 Eclipse **STAINLESS** for A-Bolt models: Stainless Stalker, White Gold Medallion and M-1000 Eclipse **IT IS IMPORTANT THAT THE CORRECT BOSS-CR BE SELECTED FOR A SPECIFIC CALIBER AND MODEL OF RIFLE.**

DESCRIPTION	SUGGESTED RETAIL
Gloss Blued	39.99
Matte Blued	39.99
Stainless	39.99

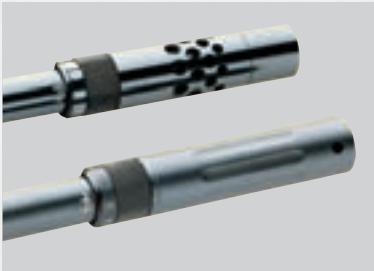

CALIBER	GLOSS BLUED	MATTE BLUED	STAINLESS
	CODE NUMBER	CODE NUMBER	CODE NUMBER
223 Rem.	1140011	1140012	1140013
223 Varmint	1140061	1140062	—
223 WSSM	1140011	1140012	1140013
243 WSSM	1140011	1140012	1140013
25 WSSM	1140011	1140012	1140013
22-250 Rem.	1140011	1140012	1140013
22-250 Varmint	1140061	1140062	—
22-250 Varmint (M-1000)	—	1140062	1140063
243 Win.	1140011	1140012	1140013
7mm-08 Rem.	1140011	1140012	1140013
308 Win.	1140021	1140022	1140023
308 Varmint	1140061	1140062	—
308 Varmint (M-1000)	—	1140062	1140063
25-06 Rem.	1140011	1140012	1140013
260 Rem.	1140011	1140012	1140013
270 WSM	1140021	1140022	1140023
270 Win.	1140011	1140012	1140013
280 Rem.	1140011	1140012	1140013
30-06 Sprg.	1140031	1140032	1140033
7mm WSM	1140021	1140022	1140023
7mm Rem. Mag.	1140021	1140022	1140023
300 WSM	1140041	1140042	1140043
300 WSM (M-1000)	—	1140092	1140093
300 Win. Mag.	1140041	1140042	1140043
300 Win. Mag. (M-1000)	—	1140092	—
325 WSM	1140051	1140052	1140053
338 Win. Mag.	1140051	1140052	1140053
375 H&H Mag.	1140071	—	1140073



INTEGRATED SCOPE MOUNT SYSTEM

Browning's Integrated Scope Mount System unitizes the ring and base into a single, ultra-rigid unit. Machined from 7000 series aluminum alloy, they eliminate alignment problems and the possibility of a loose connection between the base and ring. They are available in .400" Standard height, .500" Intermediate height and .600" High height versions for many popular Browning firearms.



X-BOLT

HEIGHT	SCOPE DIAMETER Inches / mm	FINISH	CODE NUMBER	SUGGESTED RETAIL
Standard	1	Matte	12501	92.00
Intermediate	1	Matte	12502	92.00
High	1	Matte	12503	92.00
Standard	1	Gloss	12504	92.00
Intermediate	1	Gloss	12505	92.00
High	1	Gloss	12506	92.00
Standard	30	Matte	12510	92.00
Intermediate	30	Matte	12511	92.00
High	30	Matte	12512	92.00



AB3

HEIGHT	SCOPE DIAMETER Inches	FINISH	CODE NUMBER	SUGGESTED RETAIL
Standard	1	Matte	12311	88.00
Intermediate	1	Matte	12312	88.00
High	1	Matte	12313	88.00



A-BOLT RIFLE/A-BOLT SHOTGUN

HEIGHT	SCOPE DIAMETER Inches	FINISH	CODE NUMBER	SUGGESTED RETAIL
Shotgun Standard	1	Matte	12307	88.00
Standard	1	Gloss	12390	88.00
Standard	1	Matte	12391	88.00
Intermediate	1	Gloss	12392	88.00
Intermediate	1	Matte	12393	88.00
Standard, Super Short Action	1	Matte	12380	88.00
Intermediate, Super Short Action	1	Matte	12381	88.00
Standard, Mountain Ti	1	Matte	12382	88.00
Intermediate, Mountain Ti	1	Matte	12349	88.00



BAR, BLR

HEIGHT	SCOPE DIAMETER Inches	FINISH	CODE NUMBER	SUGGESTED RETAIL
Standard	1	Gloss	12394	88.00
Standard	1	Matte	12377	88.00
Intermediate	1	Gloss	12395	88.00
Intermediate	1	Matte	12376	88.00



T-BOLT

HEIGHT	SCOPE DIAMETER Inches	FINISH	CODE NUMBER	SUGGESTED RETAIL
Standard	1	Matte	12338	88.00

EVERY BROWNING DESERVES THE BEST THERE IS IN BASES AND RINGS.

Browning firearms are designed and built to deliver outstanding accuracy. In order to maximize their accuracy potential, make sure they are equipped with genuine Browning bases and rings.



The height is determined by measuring from the top of the base to the bottom of the scope ring. Barrel contour, optic size and preferred eye relief all affect the fit of the scope on a rifle.

STANDARD HEIGHT (.300")

For scopes with an objective up to 44mm and a standard barrel contour

INTERMEDIATE HEIGHT (.400")

For scopes with an objective up to 50mm and a standard barrel contour

HIGH HEIGHT (.500")

For scopes with an objective up to 56mm and a standard barrel contour

SCOPE BASES

Browning Scope Bases are machined from solid steel • Double recoil shoulder design holds rings securely, even under magnum recoil • T-Bolt two-piece and SA-22 one-piece bases are alloy and are only compatible with Browning rimfire rings (Code 12365) • These bases are only compatible with Browning Scope Rings listed at right • Maxus, Gold, Silver, BPS, Buck Mark two-piece bases and BLR Takedown one-piece bases are Weaver-style and not compatible with Browning rings.

	HEIGHT	FINISH	PIECES	CODE NUMBER	SUGGESTED RETAIL
A A-BOLT (TWO-PIECE)					
	Standard	Matte	2	12331	53.00
	Intermediate	Gloss	2	12330	53.00
BAR, BLR (TWO-PIECE)					
	Standard	Gloss	2	12332	53.00
T-BOLT (TWO-PIECE)					
	High	Matte	2	12389	53.00
B SA-22 (ONE-PIECE)					
	Intermediate	Matte	1	12333	88.00
C X-BOLT (TWO-PIECE)					
	Standard	Matte	1	12334	61.00
	Intermediate	Gloss	1	12362	61.00

SCOPE RINGS

Ultra-rigid vertically split rings use oversize hardware for extra strength and ease of installation • Standard, Intermediate and High rings are available for both 1" and 30mm diameter scopes • Compatible with the two-piece scope bases for A-Bolt, BAR, BLR and the X-Lock bases for X-Bolt rifles listed at left • T-Bolt and SA-22 mounts use rimfire rings **RINGS SOLD IN PAIRS**

	HEIGHT	SCOPE DIAMETER Inches / mm	FINISH	CODE NUMBER	SUGGESTED RETAIL
D 1 INCH					
	Standard	1	Matte	12343	131.00
	Intermediate	1	Matte	12344	131.00
	High	1	Matte	12345	131.00
	Standard	1	Gloss	12340	131.00
	Intermediate	1	Gloss	12341	131.00
	High	1	Gloss	12342	131.00
	Standard, Rimfire	1	Matte	12365	75.00
30MM					
	Standard	30	Matte	12346	131.00
	Intermediate	30	Matte	12347	131.00
	High	30	Matte	12348	131.00



WEAVER-STYLE SCOPE BASES

Browning one- and two-piece Weaver-style scope bases are machined from aircraft grade alloy • X-Bolt bases feature a four screw per base mounting platform for a secure fit • Compatible with Browning Weaver-style scope rings below • BLR Takedown bases are Weaver-type, one-piece scout-style bases for forward mounting a long eye-relief scope

	DESCRIPTION	FINISH	PIECES	CODE NUMBER	SUGGESTED RETAIL
E AB3 (TWO-PIECE)					
	—	Matte	2	12550	29.00
A-BOLT (TWO-PIECE)					
	—	Gloss	2	12551	29.00
	—	Matte	2	12552	29.00
X-BOLT (TWO-PIECE)					
	—	Gloss	2	12553	29.00
	—	Matte	2	12554	29.00
F BLR TAKEDOWN (ONE-PIECE)					
	Short Action	Matte	1	12327	103.00
	WSM/LA/Magnum	Matte	1	12326	103.00
	450 Marlin	Matte	1	12325	103.00
G MAXUS/GOLD/SILVER/BPS (ONE-PIECE)					
	—	Matte	1	12360	53.00
H BUCK MARK (ONE-PIECE)					
	—	Matte	1	12328	53.00

WEAVER-STYLE SCOPE RINGS

Standard, Intermediate and High rings are available for both 1" and 30mm diameter scopes • Compatible with the two-piece Weaver-style scope bases for A-Bolt, BLR and X-Bolt rifles shown at left **RINGS SOLD IN PAIRS**

	HEIGHT	FINISH	CODE NUMBER	SUGGESTED RETAIL
1 INCH				
	Standard	Gloss	12555	44.00
	Intermediate	Gloss	12556	44.00
	High	Gloss	12557	44.00
	Standard	Matte	12558	44.00
	Intermediate	Matte	12559	44.00
	High	Matte	12560	44.00
30MM				
	Standard	Gloss	12561	44.00
	Intermediate	Gloss	12562	44.00
	High	Gloss	12563	44.00
	Standard	Matte	12564	44.00
	Intermediate	Matte	12565	44.00
	High	Matte	12566	44.00

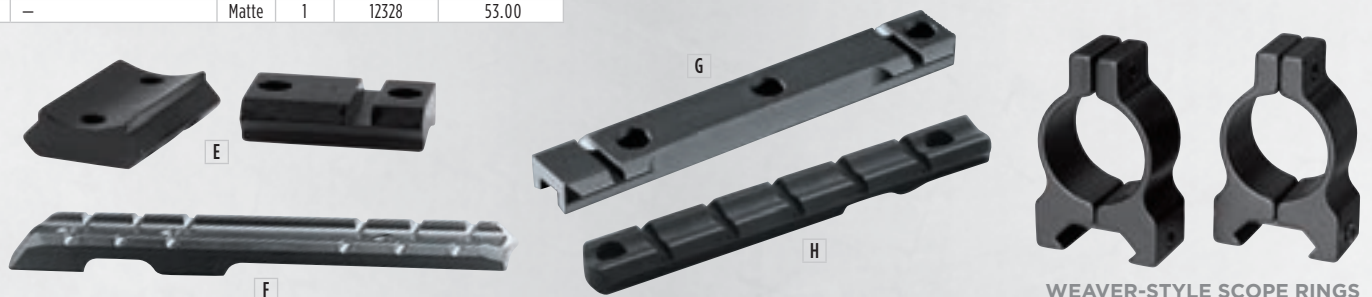

WEAVER-STYLE SCOPE RINGS

NEW CALIBERS

AB3 RIFLE MAGAZINES

Detachable staggered box magazine has a formed steel body with integrated feed lips for durability
 • Tough polymer baseplate and shoulder prevents recoil-induced bullet tip deformation and bullet setback
 • Magazine capacity is three rounds in magnum calibers and four rounds in standard calibers

NEW 2015	CALIBER	CODE NUMBER	SUGGESTED RETAIL
•	Short Action Standard: 243 Win., 7mm-08 Rem., 308 Win.	112024045	75.00
•	Short Action Magnum: 270 WSM, 300 WSM	112024044	75.00
	270 Win.	112024038	75.00
	30-06 Sprg.	112024039	75.00
	7mm Rem. Mag.	112024042	75.00
	300 Win. Mag.	112024043	75.00



A-BOLT RIFLE MAGAZINES

Hinged floorplate with detachable box magazine makes it simple and fast to load a spare magazine
 • Magnum caliber holds three cartridges • Standard caliber holds four cartridges • 223 Rem. holds five cartridges. **FITS ALL A-BOLT RIFLE MODELS EXCEPT MICRO HUNTER. NOTE: A-BOLT MAGAZINES THAT ARE NOT LISTED HERE MAY BE AVAILABLE ONLY THROUGH THE BROWNING PARTS DEPARTMENT AT (800) 322-4626.**

CALIBER	CODE NUMBER	SUGGESTED RETAIL
243 Win.	112022011	125.00
270 WSM	112022035	125.00
7mm-08 Rem.	112022016	125.00
308 Win.	112022018	125.00
300 WSM	112022034	125.00
270 Win.	112022024	125.00
30-06 Sprg.	112022026	125.00
7mm Rem. Mag.	112022027	125.00
300 Win. Mag.	112022029	125.00

A-BOLT SHOTGUN MAGAZINE

Flush-mounted detachable box magazine • Capacity of two 12 gauge shells

GAUGE	CODE NUMBER	SUGGESTED RETAIL
12	112022001	125.00

NEW 6.5 CREEDMOOR

X-BOLT RIFLE MAGAZINES

Detachable rotary magazine constructed from a durable lightweight polymer • Feeds cartridges directly in line with the bolt, instead of offset as with traditional leaf-spring magazines for a straight path right into the chamber • Ergonomic magazine-mounted release • Magnum caliber holds three cartridges • Standard caliber holds four cartridges • Unique design holds U.S. patent numbers: 8,156,675; 8,484,875 and 8,745,912

NEW 2015	CALIBER	CODE NUMBER	SUGGESTED RETAIL
	Long Action Magnum: 338 Win. Mag., 300 Win. Mag., 7mm Rem. Mag.	112044601	75.00
	Long Action Standard: 30-06 Sprg., 280 Rem., 270 Win., 25-06 Rem.	112044602	75.00
	Short Action Magnum: 325 WSM, 300 WSM, 7mm WSM, 270 WSM	112044603	75.00
	Short Action Standard: 308 Win., 7mm-08 Rem., 243 Win.	112044604	75.00
•	Short Action Standard: 6.5 Creedmoor	112044607	75.00
	Super Short Action Standard: 223 Rem.	112044008	75.00
	Super Short Action Standard: 22-250 Rem.	112044009	75.00
	Large Magnum: 375 H&H Magnum	112044606	75.00



T-BOLT RIFLE MAGAZINES

10-round capacity • Metal and polymer body • The patented Double Helix rotary box magazine uses torsion spring-driven interlocking gears for added reliability
 • Easy loading and unloading • Cartridges shown not included

CALIBER	CODE NUMBER	SUGGESTED RETAIL
22 LR	112055290	79.00
17 HMR/22 WMR	112055291	79.00





BAR MAGAZINES

Detachable box magazines for the BAR • Unique hinged floorplate design • Allows the shooter to lower the floorplate, detach the empty magazine and snap in a full magazine in mere seconds • Magnum caliber holds three cartridges • Standard caliber holds four cartridges • Mark II Safari and Lightweight Stalker WSM calibers hold two cartridges

CALIBER	CODE NUMBER	SUGGESTED RETAIL
BAR MARK II SAFARI, LIGHTWEIGHT STALKER		
243 Win. and 308 Win.	112025011	105.00
270 WSM	112025041	105.00
7mm WSM	112025042	105.00
300 WSM	112025030	105.00
BAR LONGTRAC, BAR MARK II SAFARI, BAR LIGHTWEIGHT STALKER		
270 Win., 25-06 Rem., 30-06 Sprg.	112025024	105.00
300 Win. Mag.	112025029	105.00
338 Win. Mag.	112025031	105.00
7mm Rem. Mag.	112025027	105.00
BAR SHORTTRAC		
243 Win. and 308 Win.	112025050	105.00
7mm-08 Rem.	112025051	105.00
270 WSM	112025055	105.00
7mm WSM	112025055	105.00
300 WSM	112025055	105.00
325 WSM	112025052	105.00

BLR MAGAZINES

Flush-mounted detachable box magazine • Capacity of three magnum or four standard rounds in the magazine

CALIBER	CODE NUMBER	SUGGESTED RETAIL
BLR SHORT ACTION CALIBERS		
223 Rem.	112026008	125.00
243 Win.	112026011	125.00
308 Win.	112026012	125.00
22-250 Rem.	112026009	125.00
7mm-08 Rem.	112026016	125.00
270 WSM	112026030	125.00
300 WSM	112026041	125.00
7mm WSM	112026031	125.00
325 WSM	112022067	125.00
358 Win.	112026042	125.00
450 Marlin	112026043	125.00
BLR LONG ACTION CALIBERS		
270 Win.	112026024	125.00
30-06 Sprg.	112026026	125.00
7mm Rem. Mag.	112026027	125.00
300 Win. Mag.	112026029	125.00



BUCK MARK RIFLE AND PISTOL MAGAZINE

10-round detachable box magazine • Heat treated steel body for long life • Steel coil spring for maximum feeding reliability • Fits both Buck Mark pistols and rifles

CALIBER	CODE NUMBER	SUGGESTED RETAIL
22 LR	112055190	45.00

**NEW
1911-380**

1911-380 MAGAZINE • 1911-22 MAGAZINE

10-round detachable box magazine • Heat treated steel body for long life • Steel coil spring for maximum feeding reliability with all types of rimfire ammunition

	CALIBER	CODE NUMBER	SUGGESTED RETAIL
A	1911-380	112055192	56.00
B	1911-22 LR	112055191	56.00



HI POWER PISTOL MAGAZINES

Double-stack magazine design • Available in 13-round or 10-round capacity



CALIBER	CODE NUMBER	SUGGESTED RETAIL
9mm, S.A., H.P., Standard (10-Round Capacity)	112050193	85.00
9mm, S.A., H.P., Pachmayr Pad (10-Round Capacity)	112051193	85.00
40 S&W, S.A., H.P., Standard (10-Round Capacity)	112050194	85.00
40 S&W, S.A., H.P., Pachmayr Pad (10-Round Capacity)	112051194	85.00
9mm, S.A. H.P., Standard (13-Round Capacity)	112050293	105.00
9mm, S.A., H.P., Pachmayr Pad (13-Round Capacity)	112051293	105.00



1911-22/1911-380 LOCK-PRO HOLSTER **NEW**

Molded polymer holster for secure, positive carry • Friction lock design with fully-enclosed trigger guard for added safety • Tek-Lok™ belt clip • Fits all 1911-22 and 1911-380 pistols including rail models • Pistols shown not included

	DESCRIPTION	CODE NUMBER	SUGGESTED RETAIL
A	Black	12903011	52.00
B	Desert Tan	12903013	52.00

1911  22 1911  380



1911-22/1911-380 LEATHER HOLSTERS

SLIDE HOLSTER Leather belt slide design is ideal for licensed concealed carry • Belt loops on both sides • Can be used for right-side or left-side carry either on the belt or inside the waistband **FLAP HOLSTER** Leather flap model is styled like the original U.S. Military holster • Leather ties • Embossed U.S. oval • Pistols shown not included

	DESCRIPTION	CODE NUMBER	SUGGESTED RETAIL
A	Slide Holster	12903022	26.00
B	Flap Holster	1296522	75.00

1911  22 1911  380



1911-22/1911-380 NYLON HOLSTER

Tough ballistic nylon construction with molded polymer frame and heavy duty sewn edging • Magazine pouch • Belt loop • Web strap for added safety and security • Pistol and magazine shown not included

CODE NUMBER	SUGGESTED RETAIL
12903012	39.00

1911  22 1911  380

BUCK MARK PISTOL HOLSTERS

Tough ballistic nylon construction with molded polymer frame and heavy duty sewn edging • Fits most Buck Mark pistols • Oversized model will accommodate the Buck Mark pistol fitted with a small scope or reflex sight • Magazine Pouch model keeps a spare magazine handy • Belt loop • Web strap for added safety and security • Pistols and magazines shown not included

	DESCRIPTION	CODE NUMBER	SUGGESTED RETAIL
A	Buck Mark Pistol Holster	12902010	39.00
B	Buck Mark Pistol Holster with Magazine Pouch	12902012	39.00
C	Oversized Buck Mark Holster (Fits Small Optics)	12902011	39.00





FLEX FOAM CARTRIDGE CASES

Molded Flex Foam is lightweight and durable • Holds eight or 10 centerfire rifle cartridges ready for easy access • Secure elastic cord or hook and loop closure
 • Triple stitched nylon webbed belt loop for easy carry on belt or pack strap
 • Cartridges are not included

	DESCRIPTION	CODE NUMBER	SUGGESTED RETAIL
A	8 Cartridge Case	12180	44.00
B	10 Cartridge Carrier	12191	41.00

LEATHER CARTRIDGE CASES

CRAZY HORSE CARTRIDGE CASE Distressed Crazy Horse leather construction with full edge stitching
LEATHER CARTRIDGE CASE Top-grain leather construction with full edge stitching • Both are folding designs holding 10 centerfire rifle cartridges for easy, quick access • Brass snaps • Belt loops
 • Cartridges are not included

	DESCRIPTION	CODE NUMBER	SUGGESTED RETAIL
A	Crazy Horse Leather Cartridge Case	12198	61.00
	Crazy Horse Magnum Cartridge Case	12199	61.00
B	Leather Cartridge Case	12195	59.00



FLEX FOAM CHOKE TUBE CASE

Molded foam with rugged nylon cover and full-length zipper • Holds five extended choke tubes in individual elastic bands • Improved design accommodates Invector-DS tubes • Accessory pocket holds small items • Choke tubes are not included

CODE NUMBER	SUGGESTED RETAIL
1211130	45.00

STOCK OPTION

Rugged ballistic nylon construction • Neoprene comb pad • Zipper pocket for spare ammo or cleaning gear • Attaches securely with hook and loop tabs • Accommodates sling swivels • Rifle and cartridges are not included

CODE NUMBER	SUGGESTED RETAIL
12906	53.00



GRAB SOME GLASS, THEN GO FOR THAT TROPHY BUCK.

Don't fumble for binoculars or a rangefinder when a once in a lifetime trophy offers a fleeting glimpse between the trees. With these Browning binocular accessories, a clear view is just a quick grasp away.



BINO HARNESS

Keeps binoculars accessible and holds them securely on the chest to prevent bouncing • Elastic straps allow the binoculars to slide up and down the harness • Accommodates most binoculars • Binoculars shown are not included

CODE NUMBER	SUGGESTED RETAIL
12903	39.00

BINO HUB

Protective molded foam binocular compartment with comfortable harness system relieves strain on the neck • Unique binocular attachment allows for tension-free movement • Dual position range finder holder with high-power magnetic attachment • Range finder magnet wrap fits most popular range finders • Stretchable side pouch is ideal for keeping game calls, GPS units or other small accessories at the ready • Binoculars and range finder shown not included



Unique binocular attachment allows tension-free viewing.

Comfortable harness system eliminates strain on the neck.

Backup lanyard and security bungee strap secures range finder.

CODE NUMBER	SUGGESTED RETAIL
12905	135.00

RIFLEMAN'S COMBO KIT

SPORTER SLING Features waterproof, extra-thick molded foam for the ultimate comfort • Back side is textured for a positive, non-slip grip • Swivels are not included **TWO-PIECE NEOPRENE SCOPE COVER** Stays attached to the scope • End caps offer full protection • Fits up to 40mm scopes **NEOPRENE BUTTSTOCK COVER** Slips over buttstock • Elastic loops hold rifle cartridges • Textured molded foam recoil pad for additional comfort • Rifle, scope, mounts, binoculars and cartridges are not included

CODE NUMBER	SUGGESTED RETAIL
129240	88.00



HUNTER'S COMBO KIT

SPORTER SLING Features waterproof, extra-thick molded foam for the ultimate in comfort • Back side is textured for a positive, non-slip grip • Swivels are not included **BINO HARNESS** Keeps binoculars accessible and holds them securely on the chest to prevent bouncing • Elastic straps allow the binoculars to slide up and down the harness • Accommodates most binoculars **NEOPRENE BUTTSTOCK COVER** Slips over buttstock • Elastic loops hold rifle cartridges • Textured molded foam recoil pad for additional comfort • Rifle, scope, mounts, binoculars and cartridges are not included

CODE NUMBER	SUGGESTED RETAIL
129250	88.00

BUCK MARK REFLEX SIGHT

Four reticle patterns: Circle-Dot-Cross Reticle, 3 MOA Dot Reticle, Cross-Dot Reticle, Circle-Dot Reticle • Seven-position brightness rheostat • Field-of-view: 15.7m/100m • Unlimited eye relief • Powered by one #2032 lithium battery • Mounts to any standard Weaver-style base • Rugged aluminum housing with matte black finish

CODE NUMBER	SUGGESTED RETAIL
1290230	88.00

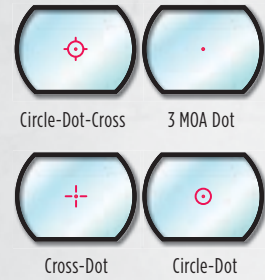

HIVIZ® BUCK MARK PISTOL SIGHT

A great performance upgrade for the Buck Mark Plus, Camper, Standard and Micro pistol models • Speeds target acquisition and provides better low-light accuracy • No batteries required • Easy single screw installation to replace factory front sight • No gunsmithing required • Includes six extra LitePipes, three green and three red

CODE NUMBER	SUGGESTED RETAIL
12875	58.00

HIVIZ® COMP SIGHT

Metal base threads directly into the bead of shotguns for a more permanent sight picture • Allows the shooter to know exactly where the barrel is in relation to the target • Interchangeable LitePipes allow shooter to match light pipe diameter and color to shooting conditions • Includes one white, four green and three red LitePipes • Used by top professional shooters • Metal base • Five screw sizes, 3/56, 3x.5, 3x.6, 5/40 and 6/48 to fit most shotguns • LitePipe changing key and custom carrying case are included (not shown)

CODE NUMBER	SUGGESTED RETAIL
12850	48.00



HIVIZ® BIRD BUSTER MAGNETIC SHOTGUN SIGHT

HiViz® Bird Buster magnetic sights come with four interchangeable LitePipes of different diameters to match different lighting conditions • Includes three sizes of magnetic bases to fit the rib of virtually any shotgun • Mounts easily with no gunsmithing required • Fits all Browning shotguns

CODE NUMBER	SUGGESTED RETAIL
12859	28.00

HIVIZ® 2-IN-1 SHOTGUN SIGHTS

High strength magnetic base attaches directly to shotgun rib • Each sight features both red and green LitePipes • Simply reverse the sight to change the color the shooter sees • Comes with both round and triangular LitePipe systems • Hunter model is designed specifically for shotguns with narrow ribs • Sporter model is designed specifically for shotguns with wider ribs • No gunsmithing required

MODEL	CODE NUMBER	SUGGESTED RETAIL
(HIVIZ 2-1 HUNTING SIGHT SHOWN)		
HiViz 2-1 Hunting Sight	12871	39.00
HiViz 2-1 Sporting Sight	12872	39.00



PICK THE RIGHT CHOKE TUBE.

Demanding shooters know that selecting the right choke tube for a specific hunting situation or challenging target presentation is a key factor in making a successful shot. That's why Browning offers such a wide selection of choke tubes, ranging from Extra-Full constrictions for turkey, coyote and goose hunters to pattern-spreading Timber n' Teal tubes for close-in flooded timber waterfowling. Every Browning choke tube is made to exacting standards to provide years of dependable service.

INVECTOR-DS

INVECTOR-DS CHOKE SYSTEM

- Invector-DS choke tubes combine muzzle-end threads and thin-wall construction for a longer, more gradual taper that produces extremely consistent, dense shot patterns that tighten consistently in reliable, evenly scaled steps.
- Muzzle threads minimize the flare at the end of the barrel for improved appearance, a faster swing and improved balance.
- A proprietary differential-banded brass seal compresses against the barrel wall when tightened to keep the choke tube threads clean and make installation and removal easier than any other muzzle thread system.
- Invector-DS is standard on A5 and Citori 725 models.
- View the full line of Invector-DS choke tubes on pages 145 and 147.

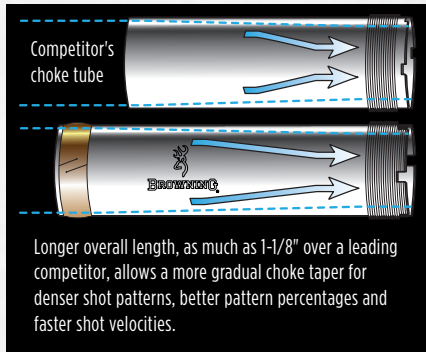
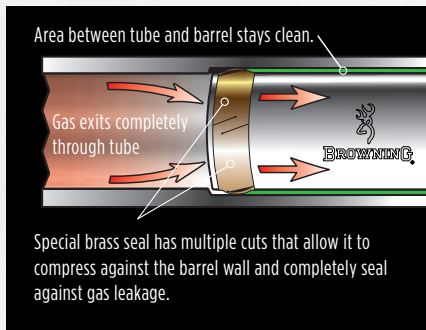

INVECTOR-Plus™

INVECTOR-PLUS CHOKE SYSTEM

- The Invector-Plus interchangeable choke tube system works with Vector Pro and back-boring to offer consistent, dense shot patterns.
- The longer choke taper inside an Invector-Plus choke tube produces consistent patterns and is far more durable than choke systems in competitors' guns, especially with steel shot.
- Invector-Plus eliminates gases slipping between the choke tube and barrel that could damage the choke tube and the barrel.
- Invector-Plus is standard on 12 and 20 gauge Maxus, Citori, Cynergy, Silver, BPS and BT-99 models.
- See pages 145 through 148 for a complete listing of choke tubes.

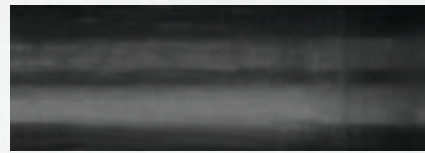

Browning's Invector choke tube is still flawless after 500 rounds of steel shot.

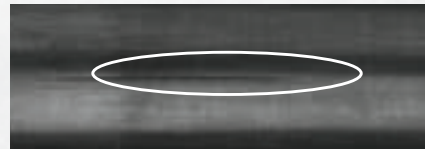

The competitor's choke tube is grooved and pitted after shooting 500 rounds of steel shot.

STANDARD INVECTOR™

STANDARD INVECTOR

- The Standard Invector interchangeable choke tube system is for Browning's non back-bored barrels and offers consistent, dense shot patterns. It's far more durable than the choke systems found in competitors' guns, especially with steel shot.
- Standard Invector eliminates gases slipping between the choke tube and barrel that could damage the choke tube and the barrel and it's standard on 10, 16 and 28 gauge, and .410 bore Citori, Cynergy, Gold and BPS models.
- See pages 145 through 148 for a complete listing of choke tubes.

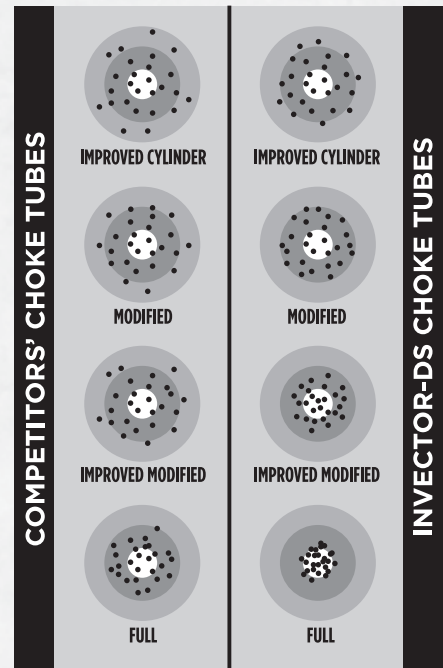

INVECTOR-DS CHOKE TUBES VS. COMPETITORS' CHOKE TUBES

Invector-DS tubes have even pattern percentage increments, offering just the right pattern for any shooting situation.

Competitors' choke tubes show little pattern difference between choke constrictions.



INVECTOR-DS EXTENDED CHOKE TUBES

Extended length tubes are easy to change and add approximately 3/4" to the overall length of the barrel • Proprietary differential banded brass gas seal eliminates residue build up and makes chokes easy to remove and install • Integrated spring suspension holds the seal tight, yet allows expansion against the barrel wall for a perfect fit and a smooth transition for shot column entering choke • Gas is controlled at the interface between choke and where it seats in the bore • From Skeet to Full choke, patterns tighten consistently and reliably • Choke tube wrenches are listed on page 149 • Flat choke tube wrench is not compatible with Invector-DS choke tubes

DESCRIPTION	PATTERN PERCENTAGE	12 GAUGE CODE NUMBER	20 GAUGE CODE NUMBER	SUGGESTED RETAIL
Full	75-80%	1134253	1134255	88.00
Light Full	70-75%	1134243	1134245	88.00
Improved Modified	65-75%	1134263	1134265	88.00
Modified	55-65%	1134273	1134275	88.00
Light Modified	45-55%	1134233	1134235	88.00
Improved Cylinder	40-45%	1134283	1134285	88.00
Skeet	35-40%	1134293	1134295	88.00

INVECTOR-DS



INVECTOR-DS FLUSH CHOKE TUBES

Standard tubes fit flush with the end of the barrel but are longer than competitors' tubes • Proprietary differential banded brass gas seal eliminates residue build up and makes chokes easy to remove and install • Integrated spring suspension holds the seal tight, yet allows expansion against the barrel wall for a perfect fit and a smooth transition for shot column entering choke • Gas is controlled at the interface between choke and where it seats in the bore • From Skeet to Full choke, patterns tighten consistently and reliably • Choke tube wrenches are listed on page 149 • Flat choke tube wrench is not compatible with Invector-DS choke tubes

DESCRIPTION	PATTERN PERCENTAGE	12 GAUGE CODE NUMBER	20 GAUGE CODE NUMBER	SUGGESTED RETAIL
Full	75-80%	1133253	1133255	58.00
Light Full	70-75%	1133243	1133245	58.00
Improved Modified	65-75%	1133263	1133265	58.00
Modified	55-65%	1133273	1133275	58.00
Light Modified	45-55%	1133233	1133235	58.00
Improved Cylinder	40-45%	1133283	1133285	58.00
Skeet	35-40%	1133293	1133295	58.00

INVECTOR-DS



MIDAS GRADE EXTENDED CHOKE TUBES

Extends beyond the end of barrel for easy removal and installation • Stainless steel with black oxide finish • Laser-etched gold accent band • Minimum gap geometry plus high-resolution "RMS" finish reduce plastic build up in bore • Invector-Plus long taper choke tube technology in 12 and 20 gauge • Produce tighter patterns than Browning Invector-Plus flush choke tubes • 28 gauge and .410 bore are Standard Invector chokes • Choke tube wrenches are listed on page 149 • Flat choke tube wrench is not compatible with Midas Grade Extended Choke Tubes • * Helically rifled to spin the shot charges and spread the pattern

DESCRIPTION	PATTERN PERCENTAGE	12 GAUGE CODE NUMBER	20 GAUGE CODE NUMBER	28 GAUGE CODE NUMBER	.410 BORE CODE NUMBER	SUGGESTED RETAIL
Extra-Full Trap	75-85%	1130123	—	—	—	79.00
Full	55-85%	1130153	1130653	1130953	1131153	79.00
Improved Modified	45-75%	1130163	1130663	1130063	1131163	79.00
Modified	35-65%	1130173	1130673	1130073	1131173	79.00
Light Modified	30-60%	1130133	1130633	1130033	1131133	79.00
Improved Cylinder	25-55%	1130183	1130683	1130083	1131183	79.00
Skeet	20-45%	1130193	1130693	1130993	1131193	79.00
Cylinder	20-45%	1130113	—	—	—	79.00
Spreader*	—	1130103	—	—	—	110.00

STANDARD **INVECTOR** **INVECTOR-Plus**



DIAMOND GRADE EXTENDED CHOKE TUBES

Longer choke taper inside Invector-Plus choke tubes for use with back-bored barrels on 12 and 20 gauge shotguns • Matching tubes for the Citori 625 Sporting • 17-4 stainless steel construction • Absolutely perfect concentricity for superior patterning • Diamond-cut knurling extends beyond the end of the barrel for easy removal and installation • Titanium nitride finish with black accent band • 28 gauge and .410 bore are Standard Invector chokes • Choke tube wrenches are listed on page 149 • Flat choke tube wrench is not compatible with Diamond Grade Extended Choke Tubes

DESCRIPTION	PATTERN PERCENTAGE	12 GAUGE	20 GAUGE	28 GAUGE	.410 BORE	SUGGESTED RETAIL
		CODE NUMBER	CODE NUMBER	CODE NUMBER	CODE NUMBER	
Full	55-85%	1134153	1135153	1136153	1137153	120.00
Improved Modified	45-75%	1134163	1135163	1136163	1137163	120.00
Modified	35-65%	1134173	1135173	1136173	1137173	120.00
Light Modified	30-60%	1134133	1135133	1136133	1137133	120.00
Improved Cylinder	25-55%	1134183	1135183	1136183	1137183	120.00
Skeet	20-45%	1134193	1135193	1136193	1137193	120.00
Cylinder	15-45%	1134113	1135113	1136113	1137113	120.00



DIANA GRADE EXTENDED CHOKE TUBES

Longer choke taper inside Invector-Plus choke tubes for use with back-bored barrels on 12 and 20 gauge shotguns • Stainless steel barstock is heat treated prior to machining • Titanium nitride surface 72HRC hardness for excellent wear and reduced plastic buildup • Absolutely perfect concentricity for superior patterning • Extends beyond the barrel for easy removal and installation • Produces tighter patterns than Browning Invector-Plus flush choke tubes • 28 gauge are Standard Invector chokes • Choke tube wrenches are listed on page 149 • Flat choke tube wrench is not compatible with Diana Grade Extended Choke Tubes • * Helically rifled to spin the shot charges and spread the pattern

DESCRIPTION	PATTERN PERCENTAGE	12 GAUGE	20 GAUGE	28 GAUGE	SUGGESTED RETAIL
		CODE NUMBER	CODE NUMBER	CODE NUMBER	
Full	55-85%	1130553	1131053	1132153	93.00
Improved Modified	45-75%	1130563	1131063	1132163	93.00
Modified	35-65%	1130573	1131073	1132173	93.00
Light Modified	30-60%	1130533	1131033	1132133	93.00
Improved Cylinder	25-55%	1130583	1131083	1132183	93.00
Skeet	20-45%	1130593	1131093	1132193	93.00
Cylinder	15-45%	1130513	—	—	93.00
Spreader*	—	1130503	—	—	128.00



INVECTOR-PLUS EXTENDED CHOKE TUBES

Constructed of highly polished stainless steel for the ultimate in performance and durability • Knurled portion extends beyond the end of the barrel for easy removal and installation • Longer choke taper inside for use with back-bored barrels • Produces excellent shot patterns with uniform densities • Set to industry construction patterns • Threaded for 12 gauge Browning Invector-Plus back-bored barrels only • Available in six constrictions from Skeet to Full • Choke tube wrenches are listed on page 149

DESCRIPTION	PATTERN PERCENTAGE	12 GAUGE CODE NUMBER	SUGGESTED RETAIL
Full	55-85%	1132253	65.00
Improved Modified	45-75%	1132263	65.00
Modified	35-65%	1132273	65.00
Light Modified	30-60%	1132233	65.00
Improved Cylinder	25-55%	1132283	65.00
Skeet	20-45%	1132293	65.00





A

B

C

**NEW
INVECTOR-DS TURKEY**

SPECIALTY EXTENDED CHOKE TUBES

Constructed of stainless steel with a black oxide finish for the ultimate in performance and durability • Knurled portion extends beyond the end of the barrel for easy removal and installation • Full Strut Turkey tube has directional porting, a camo front band and is optimized for tight patterns with #4, #5 and #6 shot sizes • Express Sabot Rifled tube has a red front band and is rifled to produce optimal accuracy from both Foster and sabot slugs • Investor-DS Turkey tube has a black accent band and an extra full constriction for improved long range patterning • Choke tube wrenches are listed on page 149 • Flat choke tube wrench is not compatible with Specialty Extended Choke Tubes

NEW 2015	DESCRIPTION	PATTERN PERCENTAGE	12 GAUGE CODE NUMBER	SUGGESTED RETAIL
A	Investor-Plus Full Strut Turkey	80-85%	1130500	125.00
B	Investor-Plus Express Sabot	—	1130863	125.00
C	Investor-DS Turkey	80-85%	1134203	88.00

INVECTOR-Plus™ *INVECTOR-DS*



DIRTY BIRD EXTENDED CHOKE TUBES

Investor-Plus Dirty Bird choke tubes are available in three constrictions for close, medium and long range shooting • Specifically designed for steel shot, particularly Winchester® Blind Side® ammunition • Longer choke taper inside Investor-Plus choke tubes for use with back-bored barrels • Constructed of 17-4 stainless steel for the ultimate in performance and durability • Long Range tube produces a 70% pattern • Medium Range tube produces a 50% pattern • Close Range tube produces a 30% pattern • Two pack includes both Long and Close Range tubes • Choke tube wrenches are listed on page 149 • Flat choke tube wrench is not compatible with Dirty Bird Extended Choke Tubes

DESCRIPTION	PATTERN PERCENTAGE	12 GAUGE CODE NUMBER	SUGGESTED RETAIL
Long Range	70%	1130210	91.00
Medium Range	50%	1130211	91.00
Close Range	30%	1130212	91.00
2-Pack	—	1130213	158.00



INVECTOR-Plus™



GRAND PASSAGE EXTENDED CHOKE TUBES

Mossy Oak® camo band • Stainless steel with black oxide finish • Superior patterning with steel shot • Threaded for 12 gauge Investor-Plus back-bored barrels only • Produces tighter patterns than Browning Investor-Plus flush choke tubes • Timber n' Teal model is helically spun to spin shot, making it excellent for tight timber, teal and close range shooting • Choke tube wrenches are listed on page 149 • Flat choke tube wrench is not compatible with Grand Passage Extended Choke Tubes • * Helically rifled to spin the shot charges and spread the pattern

DESCRIPTION	PATTERN PERCENTAGE	12 GAUGE CODE NUMBER	SUGGESTED RETAIL
Full	55-85%	1131453	95.00
Improved Modified	45-75%	1131463	95.00
Modified	35-65%	1131473	95.00
Light Modified	30-60%	1131433	95.00
Improved Cylinder	25-55%	1131483	95.00
Timber n' Teal*	—	1131493	123.00

INVECTOR-Plus™



INVECTOR-PLUS CHOKE TUBES

Invector-Plus tubes are available in constrictions ranging from Cylinder to Extra-Full • Longer choke taper inside Invector-Plus choke tubes for use with back-bored barrels • Produces excellent patterns with uniform densities • Made to industry constriction standards • Flush fit tubes do not extend beyond end of barrel (Except X-Full Turkey and X-Full Trap models) • Constructed of highly polished, 17-4 stainless steel for the ultimate in performance and durability

DESCRIPTION	PATTERN PERCENTAGE	12 GAUGE CODE NUMBER	20 GAUGE CODE NUMBER	SUGGESTED RETAIL
X-Full Turkey/Trap Spcl. (Extended Tube)	75-85%	1130833	—	88.00
Full	55-85%	1130753	1130755	43.00
Improved Modified	45-75%	1130763	—	43.00
Modified	35-65%	1130773	1130775	43.00
Improved Cylinder	25-55%	1130783	1130785	43.00
Skeet	20-45%	1130793	1130795	43.00
Cylinder	15-45%	1130803	1130805	43.00

INVECTOR-Plus™



STANDARD INVECTOR CHOKE TUBES

Standard Invector tubes are available in constrictions ranging from Cylinder to Extra-Full • Produces excellent patterns with uniform densities • Made to industry constriction standards • Flush fit tubes do not extend beyond end of barrel (Except X-Full Trap and X-Full Turkey models) • Constructed of highly polished, 17-4 stainless steel for the ultimate in performance and durability

DESCRIPTION	PATTERN PERCENTAGE	10 GAUGE CODE NUMBER	SUGGESTED RETAIL
10 GAUGE			
X-Full Turkey/Trap Spcl.	75-85%	1130311	60.00
Full	55-85%	1130251	60.00
Modified	35-65%	1130271	60.00
Improved Cylinder	25-55%	1130281	60.00

DESCRIPTION	PATTERN PERCENTAGE	12 GAUGE CODE NUMBER	16 GAUGE CODE NUMBER	SUGGESTED RETAIL
12 AND 16 GAUGE				
X-Full Trap Special (Extended Tube-12 Ga. only)	75-85%	1130323	—	88.00
X-Full Turkey/Trap Spcl. (Extended Tube-12 Ga.)	75-85%	1130343	—	88.00
Rifled Deer Spcl. Matte	—	1130363	—	108.00
Full	55-85%	1130253	1130254	42.00
Improved Modified	45-75%	1130263	—	42.00
Modified	35-65%	1130273	1130274	42.00
Improved Cylinder	25-55%	1130283	1130284	42.00
Skeet	20-45%	1130293	1130294	42.00
Cylinder	15-45%	1130303	1130304	42.00

DESCRIPTION	PATTERN PERCENTAGE	20 GAUGE CODE NUMBER	28 GAUGE CODE NUMBER	.410 BORE CODE NUMBER	SUGGESTED RETAIL
20 AND 28 GAUGE AND .410 BORE					
Full	55-85%	1130255	1130256	1130257	42.00
Modified	35-65%	1130275	1130276	1130277	42.00
Improved Cylinder	25-55%	1130285	1130286	1130287	42.00
Skeet	20-45%	1130295	1130296	1130297	42.00
Cylinder	15-45%	1130305	—	—	42.00

STANDARD INVECTOR™



SPEED WRENCH



T-WRENCH

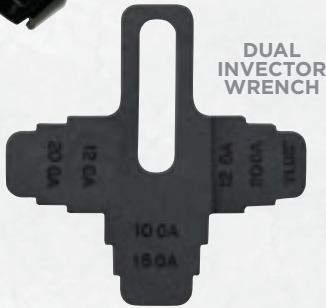

DUAL INVECTOR WRENCH



WRENCH

INVECTOR-PLUS WRENCHES

* NOT RECOMMENDED FOR USE WITH EXTENDED CHOKE TUBES.

DESCRIPTION	12 GAUGE CODE NUMBER	20 GAUGE CODE NUMBER	SUGGESTED RETAIL
12 AND 16 GAUGE			
T-Wrench	1130023	1130035	29.00
Speed Wrench	1130060	—	58.00
Wrench*	1130053	—	14.00
Dual Invector Wrench*	1130050	1130050	17.00

STANDARD INVECTOR WRENCHES

* NOT RECOMMENDED FOR USE WITH EXTENDED CHOKE TUBES.

DESCRIPTION	10 GAUGE CODE NUMBER	SUGGESTED RETAIL
10 GAUGE		
T-Wrench	—	—
Wrench*	1130048	14.00
Dual Invector Wrench*	1130050	17.00

DESCRIPTION	12 GAUGE CODE NUMBER	16 GAUGE CODE NUMBER	SUGGESTED RETAIL
12 AND 16 GAUGE			
T-Wrench	1130013	—	29.00
Wrench*	1130048	1130048	14.00
Dual Invector Wrench*	1130050	1130050	17.00

DESCRIPTION	20 GAUGE CODE NUMBER	28 GAUGE CODE NUMBER	.410 BORE CODE NUMBER	SUGGESTED RETAIL
20 AND 28 GAUGE AND .410 BORE				
T-Wrench	1130035	1130016	1130017	29.00
Wrench*	1130048	—	—	14.00
Dual Invector Wrench*	1130050	—	—	17.00





MIDAS ELECTRONIC HEARING PROTECTOR

Sharp noises like gunfire are reduced while normal speech and ambient sounds are amplified

- On/off volume controls
- Fast reaction time of just 6 milliseconds
- Operates on two AA batteries (not included)
- LED battery charge indicator
- 100-120 hours of use per set of batteries
- NRR 28dB

CODE NUMBER	SUGGESTED RETAIL
12627	105.00

BUCKMARK II HEARING PROTECTOR

Pick the color or pattern on earmuffs for a great look with any gun or gear

- Soft, comfortable foam earcups
- Foldable padded headband
- Meets ANSI S3.19 noise reduction standards
- NRR 26 dB

NEW DESIGN, COLORS AND PATTERNS

	DESCRIPTION	CODE NUMBER	SUGGESTED RETAIL
A	Black	12682	31.00
B	MOINF	12688	53.00
C	Olive	126384	31.00
D	Pink, For Her	12687	31.00
E	Purple, For Her	126396	31.00
F	Leopard, For Her	126332	53.00
G	Zebra, For Her	126339	53.00



HDR HEARING PROTECTOR

Browning's best hearing earmuff provides a noise reduction rating of 37dB

- Soft, comfortable foam earcups
- Padded and adjustable headband

CODE NUMBER	SUGGESTED RETAIL
12699	53.00

JUNIOR BUCKMARK HEARING PROTECTOR

Adjustable-fit earmuffs with padded headband for added comfort

- Meets ANSI S3.19 noise reduction standards
- Reduced size to better fit smaller heads
- Light weight makes them ideal for all day wear
- NRR 19dB
- High Visibility Green color

CODE NUMBER	SUGGESTED RETAIL
126372	31.00





ECLIPSE HEARING PROTECTOR

Unique black and gold earcups look great with one's favorite Browning guns and gear • Adjustable, padded headband folds to take up less space in a gear bag • Soft foam-padded earcups • NRR 31dB

CODE NUMBER	SUGGESTED RETAIL
12684	39.00



BEHIND THE HEAD HEARING PROTECTOR

Matte black earcups look great with any gun or gear • Lightweight and compact • Wire band fits comfortably behind the head when wearing a broad-brimmed hat • Contoured cup design doesn't interfere with the gunstock when shooting • NRR 22dB

CODE NUMBER	SUGGESTED RETAIL
12685	39.00



BANDED EAR PLUGS

Foam earplugs conform to the outer ear canal for a more comfortable fit • Plastic headband fits comfortably around the head or neck • Comes with removable foam plugs • Folds up for easy storage • NRR 22 dB • Includes one pair of replaceable foam earplugs

CODE NUMBER	SUGGESTED RETAIL
12686	12.00



A



B

NEW



C

RANGE KITS AND RANGE KIT II FOR HER

Shooting glasses with tinted polycarbonate lenses offer both eye protection and enhanced target visibility • Soft foam earplugs provide noise reduction up to 31dB and come with a plastic storage case (shown) • Adjustable-fit earmuffs with padded headband • NRR 27dB **JUNIOR** Wrap-around polycarbonate lens exceeds ANSI Z87.1 impact standards • Black temples with rubber tips for a secure, pressure-free fit • 15% size reduction from adult models to better fit smaller faces • Adjustable-fit High Visibility Green earmuffs with padded headband for added comfort • Meets ANSI S3.19 noise reduction standards • Reduced size to better fit smaller heads • NRR 19dB

DESCRIPTION	CODE NUMBER	SUGGESTED RETAIL
A Black	126368	45.00
B For Her	126373	45.00
C Junior	126371	45.00

ACE II SHOOTING GLASSES

• Tall lens profile and frameless design help eliminate visual distractions and blind spots • Interchangeable smoke, yellow, vermilion and clear lenses are included • Lenses exceed ANSI Z87.1 impact standards • Soft rubber nosepiece is removable • Rubberized temples help prevent slipping in hot or humid conditions • Includes hard storage case and microfiber cleaning cloth

CODE NUMBER	SUGGESTED RETAIL
12716	66.00

NEW



CLAYMASTER SHOOTING GLASSES

High-grade polycarbonate lenses offer 99% UV protection • Interchangeable orange, yellow, clear, smoke and blue colored lenses included • Fully adjustable frames include ratchet pitch adjustment, expandable temple length and height adjustable nose pads • Padded case and microfiber bag are included (not shown)

CODE NUMBER	SUGGESTED RETAIL
12715	59.00

BUCKMARK II SHOOTING GLASSES

High-grade wrap-around polycarbonate lenses exceed ANSI Z87.1 impact standards • Buckmark etched in left lens • Lens profile offers maximum field of vision • Choice of smoke, vermilion, yellow or clear lens • Men's glasses have matte black frame • For Her glasses have pink frame with black temple insert and special women's lens profile • Built in rubber nosepiece • Vented temples with rubber tips for a secure, pressure-free fit • Extreme styling for versatile wear • Imprinted microfiber storage bag included (not shown)

DESCRIPTION	CODE NUMBER	SUGGESTED RETAIL
A Vermilion/For Her	12723	26.00
B Vermilion	12724	26.00
C Clear	12725	26.00
D Yellow	12726	26.00



BUCKMARK JUNIOR SHOOTING GLASSES

Wrap-around single polycarbonate lenses exceed ANSI Z87.1 impact standards • Black temples with rubber tips for a secure, pressure-free fit • 15% size reduction from adult models to better fit smaller faces • Buckmark logo imprint

CODE NUMBER	SUGGESTED RETAIL
12722	20.00



GUN CLEANING MAT

The safe way to protect both firearms and furniture • Soft, felt-like fabric won't damage firearms • Waterproof Zorb Tech™ backing stops spills from migrating and inhibits the soak-through of cleaners • Mat measures 16" x 54" for plenty of working room while keeping small parts in their place and organized • Washable, dryable and highly stain-resistant • Shotgun shown is not included

CODE NUMBER	SUGGESTED RETAIL
12420	33.00



32-PIECE GUN CLEANING KIT

3-piece brass cleaning rod with machined aluminum handle • Includes bronze brushes, mops, slot-tip jags and adaptors • Cleaning pick and double-ended utility brush • Polishing cloth and 25 cloth cleaning patches • Custom-fit EVA soft-sided case with removable bandoliers and accessory pouches

CODE NUMBER	SUGGESTED RETAIL
12445	68.00

SCREWDRIVER TOOL SET

51-piece tool set is compact and convenient • Custom-molded driver handle with magnetic tip • 12 flat head bits, 8 hex bits, 4 Phillips bits, 2 extra-long Phillips bits, 7 Torx® bits, 4 Robertson bits, 4 Tri-wing bits, 3 Clutch bits, 2 Spline bits, 3 Torq bits and one 1/4" socket adaptor • Rugged double-injected fitted plastic case with clear lid and sliding closure • Ideal for hunting cabin, work bench or gun box

CODE NUMBER	SUGGESTED RETAIL
12401	45.00



UNIVERSAL CLEANING KIT

35-piece kit is packaged in a fitted aluminum-frame carry case with molded handle • Includes two sets of sectioned brass cleaning rods: One for small caliber rifles and pistols (.17-.280) and one for large caliber rifles, pistols (.30 and larger) and shotguns • Ten bronze brushes, .17-.45 caliber including three shotgun brushes 12 gauge, 20 gauge, and .410 bore • Six wool mops from .17 caliber to 12 gauge • Six jags, two slotted patch holders, brush adaptors, one PSH handle, handle adaptor and 50 fabric cleaning patches

CODE NUMBER	SUGGESTED RETAIL
12444	88.00

SNAP CAPS

Precisely matches the dimensions of live 12 gauge shells • Offers a safe way to practice trigger pull • Withstands repeated dry-firing practice • Will not harm firing pins or chambers • Sold in pairs

CODE NUMBER	SUGGESTED RETAIL
12465	44.00





PRE-PACKAGED 4-STEP GUN CLEANER

Includes Carbon Cleaner, Bore Polish, 10 oz. Solvent Degreaser and Gun Oil

CODE NUMBER	SUGGESTED RETAIL
123400	64.00



STEP 1: CARBON REMOVER

Proprietary formula quickly removes carbon build up
 • Evaporates quickly • Contains no ammonia, pH neutral
 • Pinpoint applicator • 4 oz. bottle

CODE NUMBER	SUGGESTED RETAIL
124023	16.00



STEP 2: BORE POLISH

Proprietary formula improves bore condition while safely removing accuracy-harming copper build up • Removes copper, lead and powder residue • Evaporates quickly • Contains no ammonia, pH neutral
 • Pinpoint applicator • 4 oz. bottle

CODE NUMBER	SUGGESTED RETAIL
124024	22.00



STEP 3: SOLVENT AND DEGREASER

Safely removes residue from Carbon and Bore Polish cleaners
 • Fast-drying solvent displaces water • Contains no chlorine, ozone safe • Rapidly cuts through oil and grease • Leaves no residue • 19 fl. oz. aerosol can

CODE NUMBER	SUGGESTED RETAIL
124025	19.00



STEP 4: GUN OIL

Proprietary formula passes strict military requirements • Low surface tension provides excellent lubrication and corrosion protection • Contains no synthetics • 2 oz. bottle with pinpoint applicator or 6 fl. oz. aerosol can

	DESCRIPTION	CODE NUMBER	SUGGESTED RETAIL
A	2 oz.	124032	13.00
B	6 oz.	124040	23.00



HIGH GRADE KNIVES FOR THE DEMANDING OUTDOORSMAN.

For decades our knives have been highly regarded by the world's most demanding bladesmen. Our new High Grade Knives are the most magnificent and eye-catching examples of the bladesmithing arts we have ever offered. Some of these jewel-like examples will be acquired for the pure enjoyment of their design, craftsmanship and quality. Others are destined to become an investment for the serious knife collector. Still others will spend adventurous lives far afield, riding the high range on the belt of the avid hunter or the professional guide. Wherever they may roam, we know that each and every one of these Browning High Grade knives will be treasured, enjoyed, and in due time, passed along to the next generation of outdoorsmen. Like all Browning knives, these classic blades are, and shall always be, a cut above the rest.



EXPLORING THE ROAD TO DAMASCUS STEEL.

Like the stripes of a wild animal, the laminated bands of a genuine Damascus blade ripple and shimmer in the sunlight, giving true delight to the knowledgeable eye. A product of folding and hot-forging layer upon layer of high-quality steel, each Damascus blade is a unique expression of the knifemaker's art. These laminations create a robust cutting edge capable of long service and yet they remain easy to sharpen to a razor's edge. When a Damascus knife says Browning on the side it's The Best There Is.



STORM FRONT DAMASCUS **NEW MODELS**

TYPE Fixed blade **BLADE** Hand-forged Damascus steel • Hollow ground blade on Stag models • Flat ground blade on Black Ash models **HANDLE** Stag or stabilized Black Ash hardwood **FEATURES** Fine leather sheath • Made in the USA

NEW 2015	MODEL	DESCRIPTION	OVERALL LENGTH	BLADE LENGTH	CODE NUMBER	SUGGESTED RETAIL
A	• 0218	Stag Clip Point	9	4-1/4	3220218	333.00
B	• 0217	Stag Drop Point	8-3/4	4-1/4	3220217	333.00
C	218	Big Belly Skinner	7-5/8	3-1/2	322218	306.00
D	219	Drop Point	7-1/2	3-1/2	322219	306.00



DAMASCUS FOLDERS **NEW**

TYPE Folding blade **BLADE** Hollow ground Damascus steel **HANDLE** Full Damascus, Mother-of-Pearl or Mammoth Tooth **FEATURES** Damascus bolsters • Laser cut Buckmark in blade

MODEL	DESCRIPTION	OVERALL LENGTH	BLADE LENGTH	CODE NUMBER	SUGGESTED RETAIL
A	0240 Full Damascus	7-1/4	3-1/16	3220240	222.00
B	0241 Mother-of-Pearl	7-1/4	3-1/16	3220241	333.00
C	0242 Mammoth Tooth	7-1/4	3-1/16	3220242	555.00



ESCALADE **NEW**

TYPE Fixed blade **BLADE** Mirror polished 9Cr stainless steel **HANDLE** Genuine jigged bone scales • Mirror polished stainless steel bolsters **FEATURES** Top-grain leather sheath

	MODEL	DESCRIPTION	OVERALL LENGTH	BLADE LENGTH	CODE NUMBER	SUGGESTED RETAIL
A	0131	Drop Point	7-1/4	3-1/4	3220131	122.00
B	0130	Skinner	6	2-1/2	3220130	88.00
C	0132	Bird and Trout	8-5/8	4-1/8	3220132	122.00



NON-TYPICAL STAG **NEW MODELS**

TYPE Fixed blade or folding blade **BLADE** 9Cr18MoV stainless steel • New clip point model has Sandvik 12C27 stainless steel **HANDLE** Genuine stag • New clip point model has a Grade IV walnut spacer pinned behind the guard **FEATURES** Fixed blade models include a top grain leather sheath

	NEW 2015	MODEL	DESCRIPTION	OVERALL LENGTH	BLADE LENGTH	CODE NUMBER	SUGGESTED RETAIL
A	•	0227	Fixed Clip Point Blade	7-3/4	3-1/2	3220227	166.00
B	•	0226	Folder	8	3-1/2	3220226	61.00
C		424	Fixed Skinning Blade	7	2-7/8	322424	122.00
D		423	Fixed Drop Point	7	2-7/8	322423	122.00



FEATHERWEIGHT

TYPE Fixed and folding **BLADE** Hollow ground, brushed finish AUS-8 stainless steel **HANDLE** Black Zytel® synthetic with contrasting tropical hardwood insert **FEATURES** Buckmark medallion on handle • All models except Small Folder and Multi-Blade have rugged Ballistic Cloth nylon belt sheaths

MODEL	DESCRIPTION	OVERALL LENGTH	BLADE LENGTH	CODE NUMBER	SUGGESTED RETAIL
A	928 Fixed Drop Point	8-1/4	3-5/8	322928	73.00
B	946 Fixed Semi-Skinner	8-1/8	3-3/8	322946	73.00
C	929 Fixed Guthook	8-1/2	3-7/8	322929	86.00
D	908 Large Folder	7-3/4	3-3/8	322908	61.00
E	950 Small Folder	4-7/8	2-1/8	322950	49.00
F	918 Big Game	6-1/8	3-1/2	322918	98.00
G	972 Multi-Blade	5	2-1/4	322972	61.00

BUCKMARK ART

TYPE Folding liner lock **BLADE** Mo-V Molybdenum/Vanadium steel **HANDLE** Micarta with Mother-of-Pearl art inlay on Model 721 • G-10 with Abalone inlay on Model 719 **FEATURES** Pocket clip and thumbstud

MODEL	DESCRIPTION	OVERALL LENGTH	BLADE LENGTH	CODE NUMBER	SUGGESTED RETAIL
A	721 Large	7-1/8	3	322721	78.00
B	719 Small	5-1/4	2-1/4	322719	61.00





Each tool has its own pocket in the durable roll-up nylon case, making storage and transport a breeze.

D.I.Y. BUTCHER KIT

TYPE Multiple tool field butcher's kit **BLADES** 420 stainless steel • Brushed satin finish with Browning logo **HANDLE** Durable injection molded synthetic rubber handles offer ribbed texture ridges for a sure grip **FEATURES** Includes a 7-1/2" fillet knife, 6-1/2" butcher knife, 5-1/2" boning knife (also available separately), 4" skinning knife and a 3-1/2" folding lockback drop point knife • Full size sharpening steel, 3-1/2" game shears and a Night Seeker LED cap light • Three larger knives have detachable hard polymer protective sheaths • Two smaller knives have durable nylon belt sheaths • Black nylon compartmented tool roll is included

MODEL	DESCRIPTION	OVERALL LENGTH	BLADE LENGTH	CODE NUMBER	SUGGESTED RETAIL
A 100	Butcher Kit	—	—	322100	111.00
100C	Butcher Kit, Clamshell Model	—	—	322100C	111.00
B 116	D.I.Y. Boning Knife	7-1/2	3-5/8	322116	22.00



WHITE WATER FILLET **NEW**

TYPE Fixed blade **BLADE** 420 J2 bright stainless steel **HANDLE** Washable injection molded gold polymer with contrasting black soft textured grip inserts • Nylon lanyard **FEATURES** Hard polymer protective sheath with Buckmark cut-out

MODEL	OVERALL LENGTH	BLADE LENGTH	CODE NUMBER	SUGGESTED RETAIL
0100	12-1/2	7-1/4	3220100	17.00



WOODS RUNNER

TYPE Fixed blade **BLADE** Hollow ground, brushed finish 8Cr13MoV stainless steel **HANDLE** Black G-10, Coyote Tan G-10 or Arizona Desert Ironwood hardwood scales • Contrasting carbon fiber insert • Stainless steel spacers • Mosaic handle pins **FEATURES** G-10 models have rugged black Ballistic Cloth nylon belt sheaths • Ironwood model has brown top grain leather belt sheath

MODEL	DESCRIPTION	OVERALL LENGTH	BLADE LENGTH	CODE NUMBER	SUGGESTED RETAIL
A 617	Desert Ironwood	7-1/2	3-5/8	322617	67.00
B 619	Black G-10	7-1/2	3-5/8	322619	60.00
C 636	Coyote Tan G-10	7-1/2	3-5/8	322636	60.00



PURSUIT **NEW MODEL**

TYPE Fixed blade and folding lockback **BLADE** 440 stainless steel **HANDLE** Highly figured burl wood, cocobolo, stag, sheep horn or black G-10 laminate • Double bolsters
FEATURES Nylon sheath on fixed blade models • Value priced

NEW 2015	MODEL	DESCRIPTION	OVERALL LENGTH	BLADE LENGTH	CODE NUMBER	SUGGESTED RETAIL
A	508	Burl Wood Fixed	7-1/8	3-3/8	322508	33.00
B	0270	Cocobolo Fixed	7-1/8	3-3/8	3220270	33.00
C	839	Stag Folder	6-1/2	2-3/4	322839	44.00
D	837	Sheep Horn Folder	6-1/2	2-3/4	322837	28.00
E	835	Burl Wood Folder	6-1/2	2-3/4	322835	22.00
F	832	Black G-10 Folder	6-1/2	2-3/4	322832	22.00



STAG LIL' BIT

TYPE Folding lockback **BLADE** Sandvik® 12C27 stainless steel **HANDLE** Genuine stag • Stainless steel bolsters with rack and skull engraving **FEATURES** Braided leather lanyard

MODEL	OVERALL LENGTH	BLADE LENGTH	CODE NUMBER	SUGGESTED RETAIL
794	6-1/2	2-3/4	322794	55.00



Lil' Bit logo is engraved on the rear bolster.

BROWNING FOR HER

TYPE Folding locking liner **BLADE** Swedish Sandvik® 12C27 stainless steel **HANDLE** Aluminum with pink and camo Dura-Touch Armor Coating • Anodized aluminum bolsters **FEATURES** Rugged nylon sheath and pocket clip

MODEL	OVERALL LENGTH	BLADE LENGTH	CODE NUMBER	SUGGESTED RETAIL
894	6-3/8	2-3/4	322894	31.00



GAME REAPER SAW

TYPE T-handle pelvic saw and guthook **BLADE** 440-C stainless **HANDLE** Contour molded composite • T-shaped handle • Machined grooves for a sure grip with better control
FEATURES Durable black nylon belt sheath with hook and loop flap closure

MODEL	OVERALL LENGTH	BLADE LENGTH	CODE NUMBER	SUGGESTED RETAIL
926	5-7/8	3-3/4	322926	24.00



T-Handle Saw comes with a durable nylon belt sheath.



MODEL 111

TYPE Folding lockback **BLADE** Sandvik® 12C27 stainless steel **HANDLE** Canoe handle with finger grooves
 • Model 111C has Cocobolo hardwood scales and white brass bolsters • Model 111D has black G-10 scales and stainless steel bolsters **FEATURES** Nylon sheath included (not shown)

MODEL	DESCRIPTION	OVERALL LENGTH	BLADE LENGTH	CODE NUMBER	SUGGESTED RETAIL
A	111C Cocobolo	7-3/4	3-1/4	322111C	44.00
B	111D Black G-10	7-3/4	3-1/4	322111D	39.00

CLASSIC

TYPE Folding lockback **BLADE** Stainless steel drop point with laser engraving and gold-tone Buckmark in oval frame **HANDLE** Brushed stainless steel, dark tropical hardwood or genuine stag scales
 • Brushed stainless bolsters **FEATURES** Ultra-thin construction of the knife lets it slide easily into the pocket without adding excess bulk

MODEL	DESCRIPTION	OVERALL LENGTH	BLADE LENGTH	CODE NUMBER	SUGGESTED RETAIL
A	368 Stag	5-1/2	2-5/8	322368	37.00
B	367 Wood	5-1/2	2-5/8	322367	24.00
C	366 Stainless	5-1/2	2-5/8	322366	24.00



DIRTY BIRD AND TROUT

TYPE Fixed blade or folder **BLADE** 440 stainless steel with titanium coating • Unique blade shape • Perfect for intricate cuts in tight places like wing joints **HANDLE** Aluminum alloy with Mossy Oak® Duck Blind® camo • Titanium coated bolster • Oval-shaped lanyard eye
FEATURES Nylon sheath

MODEL	DESCRIPTION	OVERALL LENGTH	BLADE LENGTH	CODE NUMBER	SUGGESTED RETAIL
A	350 Fixed	8-3/8	3-1/2	322350	33.00
B	339 Folder	8-1/2	3-1/2	322339	33.00



COCOBOLO BIG GAME

TYPE Hidden tang fixed blade **BLADE** 440 stainless steel **HANDLE** Cocobolo hardwood with brass and bone accents **FEATURES** Includes a top-grain leather sheath

MODEL	OVERALL LENGTH	BLADE LENGTH	CODE NUMBER	SUGGESTED RETAIL
529	8-1/2	3-3/4	322529	61.00



TAGGED OUT

TAGGED OUT

TYPE Folding liner lock **BLADE** 8Cr13MoV stainless steel **HANDLE** Aircraft-grade aluminum with Mossy Oak® Break-Up Infinity® camo • Dura-Touch Armor Coating **FEATURES** Pocket clip • Folding scissors

MODEL	OVERALL LENGTH	BLADE LENGTH	CODE NUMBER	SUGGESTED RETAIL
207	8-1/4	3-1/2	322207	44.00



FULL CURL SHEEP

TYPE Folding lockback **BLADE** 440 stainless steel drop point **HANDLE** Genuine sheep horn handle with brass pins • Solid nickel silver bolsters **FEATURES** Top grain leather belt sheath with snap flap included

MODEL	OVERALL LENGTH	BLADE LENGTH	CODE NUMBER	SUGGESTED RETAIL
107	6-5/8	2-5/8	322107	44.00



KODIAK F.D.T. (FIELD DRESSING TOOL)

TYPE Folding lockback **BLADE** 440 stainless steel drop point **HANDLE** Anodized aluminum **FEATURES** Two different locking systems — button liner lock and a lockback • Ballistic Cloth nylon sheath, that can be worn in either the horizontal or vertical position, included (not shown)

MODEL	OVERALL LENGTH	BLADE LENGTH	CODE NUMBER	SUGGESTED RETAIL
629	8	3-1/2 Main blade	322629	44.00

CAMPMATE

TYPE Folding with liner lock knife **BLADE** 440 stainless steel knife blade, fork and spoon **HANDLE** Injection-molded checkered composite **FEATURES** Nylon sheath included (not shown)

MODEL	OVERALL LENGTH	BLADE LENGTH	CODE NUMBER	SUGGESTED RETAIL
970	7-3/4	3-1/4	322970	24.00





NEW MODELS
PRISM II
TYPE Folding liner lock **BLADE** 440-A stainless steel **HANDLE** Color anodized machined aluminum, MOINF, carbon fiber print or zebra safari print scales
 • Matte aluminum bolster with Buckmark logo • **FEATURES** Pocket clip • Thumbstud

NEW 2015	MODEL	DESCRIPTION	OVERALL LENGTH	BLADE LENGTH	CODE NUMBER	SUGGESTED RETAIL
A	5662	Black	5-5/8	2-1/2	3225662	17.00
B	5622	Pink	5-5/8	2-1/2	3225622	17.00
C	5632	Orange	5-5/8	2-1/2	3225632	17.00
D	5672	Mossy Oak Break-Up Infinity	5-5/8	2-1/2	3225672	17.00
E	776	Zebra	6-1/4	2-3/4	322776	17.00
F	• 5692	Crimson	5-5/8	2-1/2	3225692	17.00
G	• 5682	Violet	5-5/8	2-1/2	3225682	17.00
H	• 5612	Aqua	5-5/8	2-1/2	3225612	17.00
I	• 779	Carbon Fiber	5-5/8	2-1/2	322779	17.00



MOUNTAIN Ti
TYPE Folding frame lock **BLADE** 440-A stainless steel drop point • Titanium coated for added corrosion resistance **HANDLE** Machined 420J1 stainless steel with two-tone gray finish
 • Laser cut Buckmark logo • Titanium coated **FEATURES** Pocket clip • Ambidextrous thumbstud • Lanyard eyelet

MODEL	DESCRIPTION	OVERALL LENGTH	BLADE LENGTH	CODE NUMBER	SUGGESTED RETAIL
A	Small	5	2-1/4	322561	22.00
B	Medium	6-3/8	3	322560	28.00



HELL'S CANYON AND HELL'S BELLES
TYPE Folding lockback **BLADE** 7Cr stainless steel **HANDLE** Stainless steel bolsters • Finger choils • MOINF and MO Pink models have aluminum scale inserts • Blaze model has G-10 scale inserts **FEATURES** Anti-skid grooves on blade spine

NEW 2015	MODEL	DESCRIPTION	OVERALL LENGTH	BLADE LENGTH	CODE NUMBER	SUGGESTED RETAIL
A	639	Mossy Oak Break-Up Infinity	7-1/4	3-1/8	322639	44.00
B	624	Blaze G-10	7-1/4	3-1/8	322624	33.00
C	• 765	Mossy Oak Pink	7-1/4	3-1/8	322765	44.00



HOG HUNTER

TYPE Fixed blade **BLADE** 7" hollow ground 440 stainless steel • Laser-engraved Hog Hunter logo **HANDLE** Molded synthetic rubber with checkered surface for improved grip **FEATURES** Includes black nylon sheath

MODEL	OVERALL LENGTH	BLADE LENGTH	CODE NUMBER	SUGGESTED RETAIL
865	12	7	322865	56.00

CROWELL/BARKER COMPETITION

TYPE Fixed blade competition **BLADE** Heavy drop point made from high-carbon steel with a .142 satin finish • Designed by World Cutting Champions James Crowell and Reggie Barker • Laser-etched on one side with Browning logo **HANDLE** Resin-laminated canvas scales with three rivets and wrist lanyard **FEATURES** Custom-made top-grain leather belt sheath • Certificate of Authenticity signed by Crowell and Barker • Approved for select International Cutting Competition Trail (ICCT) events

MODEL	OVERALL LENGTH	BLADE LENGTH	CODE NUMBER	SUGGESTED RETAIL
580	15	10	322580	183.00



MINNOW NEW

TYPE Folding blade **BLADE** 7Cr stainless steel **HANDLE** Anodized two-tone aluminum **FEATURES** Lanyard eye • Thumb stud • Laser-cut Buckmark in blade • Ultra-thin construction lets the knife slide easily into the pocket without adding excess bulk

	MODEL	DESCRIPTION	OVERALL LENGTH	BLADE LENGTH	CODE NUMBER	SUGGESTED RETAIL
A	0060	Slate/Black	4-3/4	1-7/8	3220060	17.00
B	0061	Neon Green/Black	4-3/4	1-7/8	3220061	17.00
C	0062	Neon Orange/Black	4-3/4	1-7/8	3220062	17.00
D	0063	Neon Pink/Black	4-3/4	1-7/8	3220063	17.00

VORTEX NEW

TYPE Fixed blade and folding liner locks **BLADE** 440 stainless steel with titanium coating • Anti-skid grooves on blade spine • Ambidextrous thumb studs on folders **HANDLE** Black G-10 scales • Carbon fiber bolsters • Finger groove handle design **FEATURES** Nylon sheath on fixed blade model • Buckmark pocket clip on folders

	MODEL	DESCRIPTION	OVERALL LENGTH	BLADE LENGTH	CODE NUMBER	SUGGESTED RETAIL
A	7532	Fixed Blade	8-7/8	3-3/4	3227532	61.00
B	7530	Drop Point	8	3-3/8	3227530	33.00
C	7531	Bird & Trout	7-3/4	3-3/8	3227531	33.00



Unique laser cut Buckmark pocket clip.





SCRIMSHAW

TYPE Folding lockback **BLADE** Hollow ground, satin-finished 420-J2 stainless steel • Laser-engraved Browning logo **HANDLE** Finely polished zinc casting for heft and balance • Laser-engraved Buckmark logo • Adorned with scrimshaw wildlife artwork on a polymer ivory-colored panel **FEATURES** Brush finished back with Browning logo • All models include presentation box

MODEL	DESCRIPTION	OVERALL LENGTH	BLADE LENGTH	CODE NUMBER	SUGGESTED RETAIL
A	540 Whitetail	7	2-7/8	322540	73.00
B	541 Mule Deer	7	2-7/8	322541	73.00
C	542 Elk	7	2-7/8	322542	73.00
D	543 Mallard	7	2-7/8	322543	73.00
E	544 Pheasant	7	2-7/8	322544	73.00
F	545 Turkey	7	2-7/8	322545	73.00
G	547 Labrador	7	2-7/8	322547	73.00



CAYMAN NEW

TYPE Folding blade **BLADE** 7Cr stainless steel **HANDLE** Double injection molded • Anodized aluminum bolsters **FEATURES** Pocket clip

MODEL	DESCRIPTION	OVERALL LENGTH	BLADE LENGTH	CODE NUMBER	SUGGESTED RETAIL
A	0035 Black and Gray	7-3/4	3-3/8	3220035	22.00
B	0036 Black and Tan	7-3/4	3-3/8	3220036	22.00



Ignite

IGNITE NEW

TYPE Fixed blade **BLADE** 7Cr stainless steel • Titanium blade coating on gray model • Black oxide blade coating on orange model • Sparking bevel on spine **HANDLE** Polymer with molded contrasting grip inserts and lanyard eyelet **FEATURES** Rugged polymer sheath • Fire starting flint with polymer handle inserts into sheath

MODEL	DESCRIPTION	OVERALL LENGTH	BLADE LENGTH	CODE NUMBER	SUGGESTED RETAIL
A	0160 Black and Gray	8-1/2	4	3220160	33.00
B	0161 Black and Orange	8-1/2	4	3220161	33.00





Includes tough nylon sheath with snap closure.

OUTDOORSMAN AXE

TYPE Axe **BLADE** One-piece head is hot-forged, hollow ground, high carbon 1055 tool steel **HANDLE** Reinforced polymer **FEATURES** Handle is shaped for easy hand placement when cutting kindling • Sheath included



MODEL	CODE NUMBER	SUGGESTED RETAIL
231	322231	78.00

OUTDOORSMAN SHEARS

TYPE Shears **BLADE** High carbon tool steel **HANDLES** Tough polypropylene and rubber • Telescopes from 21" to 28" **FEATURES** Lower blade is serrated on one edge • Large guthook • Sheath included



MODEL	CODE NUMBER	SUGGESTED RETAIL
230	322230	61.00

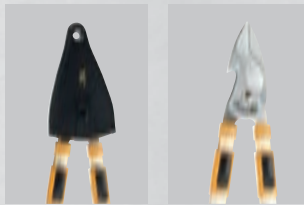

Includes tough nylon sheath with snap closure.



OUTDOORSMAN SHOVEL

TYPE Folding shovel **BLADE** 8-5/8" High carbon tool steel **HANDLE** Tough 22-1/2" tubular metal handle with D-shaped grip **FEATURES** Nylon pouch included (not shown)

MODEL	CODE NUMBER	SUGGESTED RETAIL
919	322919	39.00



KNIFE SHARPENER **NEW**

TYPE Sharpener **BLADE** Two carbide steel sharpening inserts **HANDLE** Anodized alloy Buckmark **FEATURES** Quickly sharpens most blades • Ideal for pocket, pack, kitchen, cabin or camp • Includes split key ring

MODEL	OVERALL LENGTH	BLADE LENGTH	CODE NUMBER	SUGGESTED RETAIL
0010	3-3/16	1/4	3220010	9.00

CAMP SAW

TYPE Folding camp saw **BLADE** 4116 stainless steel with push/pull saw teeth **HANDLE** Injection molded composite with rubber gripping inlays • Finger grooves and large tail radius for greater comfort and control **FEATURES** Button securely locks the blade in both the open and closed position • Included nylon sheath can be worn in vertical or horizontal position (not shown)

MODEL	CODE NUMBER	SUGGESTED RETAIL
922	322922	28.00



HOW TO CHOOSE A FLASHLIGHT

Browning is a leading manufacturer of portable battery-powered lighting for hunters and shooters with more than 35 styles in the product line. To choose the best light — read on.

SIZE, WEIGHT AND POWER

When choosing a light, smaller, brighter and lighter are better. Today's high-output LEDs from manufacturers like Luxeon® and Cree® are so powerful and efficient they achieve the same light output as the old multi-cell C and D lights. The super bright Alpha and Alpha Max Flashlights use a single AA battery yet are not much bigger than a shotgun shell.

LED VS. XENON BULBS

LEDs are preferred over Xenon bulbs for most uses, thus all our lights are now LED designs. LEDs use batteries more efficiently, illuminate at greater distances, emit a clean, even beam and will never burn out under normal use. Like most technology, LEDs keep getting better every year. For 2015 many of our lights offer upgraded LEDs with 10% - 400% more output.

HAND-HELD OR HANDS-FREE

Headlamps and cap lights allow the use of both hands for tasks like dressing a deer, fixing a truck or finding a path through the woods. Modern technology makes many headlamps as powerful as larger hand-held flashlights. The MicroBlast headlamp can be worn either as a headlamp, clipped to a shirt pocket or to the brim of a hat.

LONG RUN TIME

By using advanced digital circuitry, highly efficient LEDs and low-resistance switches, we are able to offer extra long run times on many lights. Most Tactical Hunter lights will run for 20-48 hours on the low setting. The High Noon 4C Spotlight will run for 8 days at the low setting. These extended run times could be the difference between getting home safely and spending a night in the woods.

WATERPROOF AND SUBMERSIBLE

Because the great outdoors doesn't always have great weather, we have redesigned most flashlights to be waterproof and submersible to 3 feet for 30 minutes (ANSI IPX7). Most of our other lights are O-ring sealed for greater water resistance (IPX4). The High Noon LED Spotlight is submersible and it floats.

BATTERIES

Lithium batteries are used in many of our highest-performing lights, such as Blackout and Nitro. Lithium batteries pack twice the power of alkaline batteries for their weight, and operate well at very cold temperatures. Other lights in the line use AA and AAA alkaline batteries because they cost less than lithium and are readily available anywhere in the world. The latest integrated circuit designs in the Browning Pro Hunter and Alpha flashlights allow alkaline batteries to approach the performance of lithium batteries.

SWITCH SETTINGS

Multiple switch settings (high, low and in-between) help preserve battery life and allow selection of colors and flashing options. The lock-out switches found on most of our lights keep the light from accidentally turning on in a pack or pocket. A disorienting Fast Strobe setting is now available on many of our lights, and it has proven useful for self-protection and for signalling during an emergency.

RED, GREEN AND BLUE

Colored LEDs help preserve night vision and are great for map reading. They are less obvious than white light to many types of game animals.

FL-1 FLASHLIGHT PERFORMANCE STANDARDS

We proudly participate in the FL-1 flashlight performance standards for measuring and stating performance claims for all portable lights. This includes Brightness (Lumens), Distance, Run Time, Water Resistance and Impact Resistance. FL-1 provides the only reliable apples-to-apples comparison between models and is used by most major manufacturers. Look for these FL-1 symbols on our light packaging.*

* Our lights with multiple settings; the lumens, battery life and distances are stated at the highest setting (100% power), unless indicated otherwise.



LUMENS = BRIGHTNESS

The output of a traditional 2D cell flashlight is approximately 15 - 20 lumens. The latest LED flashlights can have an output of more than 700 lumens.



BATTERY LIFE

Battery Life (Run Time) is defined as the time elapsed from when the batteries are new to when the light reaches 10% of the original brightness.

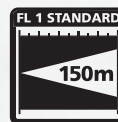

MAXIMUM DISTANCE

Maximum Distance is measured as the distance from the light source to where it decreases in brightness to 0.25 lux — about the brightness of the full moon on a clear night.

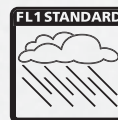

WATER RESISTANCE

Water Resistance (FL-1 Standard IPX4) is tested by spraying water onto the light from multiple directions. This simulates a heavy, all-day rain.

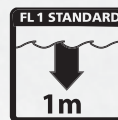

WATERPROOF AND SUBMERSIBLE

Waterproof and Submersible (FL-1 Standard IPX7) assures water cannot get inside the light. This is conducted for 30 minutes at a water depth of 1 meter (about 39").



IMPACT RESISTANCE

Impact Resistance (FL-1 Standard 1M) measures how well the light resists damage when dropped repeatedly from a height of 1 meter (about 39") onto concrete.



**NEW LED
10% BRIGHTER**



BLACKOUT

LENGTH 5-1/2" **BRIGHTNESS** 650 lumens **EFFECTIVE DISTANCE** 295 yards
FEATURES Our brightest CR123A two-battery flashlight • Powerful Cree® white LED that never needs replacing • Lock-out tailcap switch with momentary, continuous and fast strobe modes • Non-slip body and anti-roll finger retention ring • All-aluminum body construction with optically clear scratch-resistant glass lens • Waterproof • Submersible to three feet for 30 minutes • Drop tested to 1 meter • Incredible 36 hour run time on low output • CR123A batteries operate to -40° F and have 10 year shelf life

CODE NUMBER	SUGGESTED RETAIL	BATTERIES	BATTERY LIFE
3713410	122.00	(2) CR123A Lithium	High: 2 hours Low: 60 hours

ALPHA

LENGTH 4" **BRIGHTNESS** 155 lumens **EFFECTIVE DISTANCE** 85 yards
FEATURES Advanced digital circuitry delivers maximum light output using a single AA alkaline battery (included) • Unbreakable white LED • High, low and fast strobe modes • Lock-out tailcap switch with momentary and continuous modes • Waterproof • Submersible to three feet for 30 minutes • Rugged aircraft grade aluminum construction • Removable Deep Carry Pocket Clip™

CODE NUMBER	SUGGESTED RETAIL	BATTERIES	BATTERY LIFE
3711231	55.00	(1) AA Alkaline	High: 2.5 hours Low: 16 hours



**NEW LED
35% BRIGHTER**



A

**NEW LED
UP TO
225% BRIGHTER**



B



The green LED on the high-efficiency reflector is ideal for stealth and safety or to help preserve night vision.

315 LUMENS
14500 LITHIUM-ION BATTERY

155 LUMENS
AA ALKALINE BATTERY

ALPHA MAX

LENGTH 4-5/16" **BRIGHTNESS** 155 to 315 lumens **EFFECTIVE DISTANCE** 85 to 150 yards
FEATURES Advanced digital circuitry accepts either a single AA alkaline battery (included) to produce 155 lumens or a single 14500 rechargeable lithium-ion battery (not included) to produce 315 lumens • Luxeon® white LED with high and low modes • Single green LED for stealth and night use • Fast strobe mode • Lock-out tailcap switch with momentary and continuous modes • Waterproof • Submersible to three feet for 30 minutes • Rugged aircraft grade aluminum construction • Removable Deep Carry Pocket Clip™ • Camo model features Dura-Touch Armor Coating

DESCRIPTION	CODE NUMBER	SUGGESTED RETAIL	BATTERIES	BATTERY LIFE
A Black	3711239	61.00	(1) AA Alkaline or (1) 14500 Lithium	High: 1-2 hours Low: 16 hours
B Vista Camo	3711232	67.00	(1) AA Alkaline or (1) 14500 Lithium	High: 1-2 hours Low: 16 hours

DURA-TOUCH
Armor Coating

**NEW LED
20% BRIGHTER**



CATALYST

LENGTH 5" **BRIGHTNESS** 300 lumens **EFFECTIVE DISTANCE** 200 yards **FEATURES** Luxeon® Rebel LED • Lock-out tailcap switch with momentary, continuous and fast strobe modes • Removable Deep Carry Pocket Clip™ • Incredible 48 hour run time on low output • CR123A batteries operate to -40° F • All-aluminum body construction with unbreakable lens • Waterproof • Submersible to three feet for 30 minutes • Vista® camo with Dura-Touch Armor Coating

CODE NUMBER	SUGGESTED RETAIL	BATTERIES	BATTERY LIFE
3711230	86.00	(2) CR123A Lithium	High: 3 hours Low: 48 hours

DURA-TOUCH®
Armor Coating

CATALYST EXTREME GREEN VARMINT

LENGTH 5" **BRIGHTNESS** 150 lumens **EFFECTIVE DISTANCE** 200 yards **FEATURES** Green Luxeon® Rebel LED • Lock-out tailcap switch with full output momentary and continuous modes • Deep Pocket carry clip • 6 hour run time • CR123A batteries operate to -40° F • All-aluminum body construction with unbreakable lens • Waterproof • Submersible to three feet for 30 minutes • Matte black finish • Includes 1913 Picatinny rail mount and remote cable switch

CODE NUMBER	SUGGESTED RETAIL	BATTERIES	BATTERY LIFE
3711244	122.00	(2) CR123A Lithium	High: 6 hours



**NEW LED
25% BRIGHTER**



CROSSFIRE

LENGTH 5-7/8" **BRIGHTNESS** 250 lumens **EFFECTIVE DISTANCE** 150 yards **FEATURES** Uses two standard AA alkaline batteries (included) • Advanced digital circuitry • Unbreakable white LED • Rugged, lightweight polymer body • Diffuser dome attachment for soft area light and signaling beacon • Lanyard • O-ring sealed • Waterproof • Submersible to three feet for 30 minutes • Lock-out tailcap switch with high, low and strobe modes • 16 hour run time on low • Molded-in Buckmark logo

DESCRIPTION	CODE NUMBER	SUGGESTED RETAIL	BATTERIES	BATTERY LIFE
A Black	3713310	37.00	(1) AA Alkaline	High: 2 hours Low: 16 hours
B Coyote Tan	3713370	37.00	(1) AA Alkaline	High: 2 hours Low: 16 hours

HIGH NOON SPOTLIGHTS

LENGTH 5-3/4" **BRIGHTNESS** 105 to 825 lumens depending on model **EFFECTIVE DISTANCES** 400 to 645 yards depending on model **FEATURES** Powerful Cree® white LED that never needs replacing • Compact design gives incredible output (batteries not included) • Fast strobe setting for signaling • Waterproof • Submersible to three feet for 30 minutes • Floats • Lock-out switch on handle • Most models offer a rubberized soft touch finish • Rugged polycarbonate housing and flexible rubber lens ring • Built-in adjustable stand for hands free use • Lanyard included • Long run times on high output and low output settings • Available in Black, Hi-Viz Yellow and Mossy Oak® Shadow Grass Blades camo • Green Extreme model has Cree® green LED for night varmint hunting (where legal) and a single high-output mode with no strobe setting



NEW

A



**NEW LED
20% BRIGHTER**

B

**NEW LED
65% BRIGHTER**



C

**NEW LED
65% BRIGHTER**



D



E

**NEW LED
65% BRIGHTER**



F

NEW 2015	DESCRIPTION	CODE NUMBER	SUGGESTED RETAIL	BATTERIES	BATTERY LIFE	EFFECTIVE DISTANCE	LUMENS
4C HIGH NOON SPOTLIGHTS							
A	• Hi-Viz Yellow	3717790	92.00	(4) C Alkaline	High: 3 hours Low: 200 hours	645 yards	High: 825 Low: 80
B	Black	3717760	92.00	(4) C Alkaline	High: 3 hours Low: 200 hours	645 yards	High: 825 Low: 80
3C HIGH NOON SPOTLIGHTS							
C	Hi-Viz Yellow	3717750	73.00	(3) C Alkaline	High: 3 hours Low: 72 hours	400 yards	High: 500 Low: 92
D	Dirty Bird, MOSGB	3717740	86.00	(3) C Alkaline	High: 3 hours Low: 72 hours	400 yards	High: 500 Low: 92
E	Green Extreme	3717730	86.00	(3) C Alkaline	High: 40 hours	160 yards	105
F	Black	3717710	73.00	(3) C Alkaline	High: 3 hours Low: 72 hours	400 yards	High: 500 Low: 92



PRO HUNTER RGB

LENGTH 5-1/4" **BRIGHTNESS** 40 lumens **EFFECTIVE DISTANCE** 27 yards **FEATURES** Black polymer body with matte aluminum lens ring • Tactical-style lock-out end cap assures the light is not turned on accidentally • Carrying lanyard • Two high-intensity LEDs for long distance illumination • One wide view LED for maximum peripheral vision • One red-green-blue LED to enhance night vision and is shown to be stealthier around game animals • Waterproof to FL 1 meter standard • Submersible to three feet for 30 minutes • Uses affordable and easy to find AAA batteries (included)

CODE NUMBER	SUGGESTED RETAIL	BATTERIES	BATTERY LIFE
3713314	24.00	(3) AAA Alkaline	High+Wide: 25 hours High: 30 hours RGB: 40 hours

PRO HUNTER LED

LENGTH 5-1/4" **BRIGHTNESS** 110 lumens **EFFECTIVE DISTANCE** 100 yards **FEATURES** Vista camo polymer body • Matte black aluminum lens ring • Tactical-style lock-out end cap assures the light is not turned on accidentally • Carrying lanyard • Center white LED for long distance illumination • Two red and two green LEDs to enhance night vision and are shown to be stealthier around game animals • Waterproof to FL 1 meter standard • Submersible to three feet for 30 minutes • Uses affordable and easy to find AAA batteries (included)

CODE NUMBER	SUGGESTED RETAIL	BATTERIES	BATTERY LIFE
3713312	43.00	(3) AAA Alkaline	0.5 watt: 8 hours Green/Red: 50 hours

**NEW LED
400% BRIGHTER**



**NEW LED
65% BRIGHTER**



CLASSIC PRO

LENGTH 5-1/4" **BRIGHTNESS** 160 lumens **EFFECTIVE DISTANCE** 115 yards **FEATURES** Vista camo polymer body • Matte black aluminum lens ring • Center white LED for long distance illumination • Tactical tailcap switch has high, low and flashing modes • Waterproof to FL 1 meter standard • Submersible to three feet for 30 minutes • Lock-out feature protects the batteries • Uses affordable and easy to find AAA batteries (included)

CODE NUMBER	SUGGESTED RETAIL	BATTERIES	BATTERY LIFE
3713322	49.00	(3) AAA Alkaline	High: 3 hours Low: 24 hours

MICROBLAST

LENGTH 2-7/8" **BRIGHTNESS** 60 lumens **EFFECTIVE DISTANCE** 42 yards **FEATURES** Uses a single AAA alkaline battery • White LED is brighter than many 2 D flashlights • Digital circuitry delivers maximum power • Twist switch for easy lock on and off • Deep Carry Pocket Clip™ • All-aluminum construction with unbreakable lens • O-ring sealed • Waterproof to three feet for 30 minutes • Passes drop-test onto concrete from a height of more than two meters • Use as flashlight or cap light

CODE NUMBER	SUGGESTED RETAIL	BATTERIES	BATTERY LIFE
3712114	24.00	(1) AAA Alkaline	1.5 hours

**NEW LED
300% BRIGHTER**



THE NEW EPIC HEADLAMPS ARE, QUITE SIMPLY, A BRILLIANT DESIGN.

The new Browning Epic Headlamps combine single-battery power with multiple LED lampheads and high-output circuits to deliver maximum performance, along with minimal size and weight. A flexible elastomer headplate make the Epic so comfortable you might forget you're wearing one. The advanced ergonomic design keeps the light close to your head to keep a steady beam on the subject, even when you are active or in motion. They're rugged and ready to roll on an Epic adventure.

EPIC

BRIGHTNESS 20 or 225 lumens **EFFECTIVE DISTANCE** 27 or 100 yards **FEATURES** Single battery power source • Rugged matte black polymer body with Vista® camo front • LED life of 100,000 hours • Low-profile lamphead design • Soft elastomer headplate for added comfort • Silent beam angle adjustment • 1 AA Model uses two white LEDs to produce 20 lumens for general use around camp • Two green LEDs provide stealth and protect night vision • Hold down mode switch for three seconds to activate Fast-Strobe with white LEDs • 3V model has super-bright white LED producing 225 lumens that reaches out to 100 yards • Two lower-output white LEDs are ideal for general use around camp • Two green LEDs offer stealth and protect night vision



NEW



NEW

DESCRIPTION	CODE NUMBER	SUGGESTED RETAIL	BATTERIES	BATTERY LIFE
A 1AA	3718640	24.00	(1) AA Alkaline	White: 6 hours Green: 8 hours
B 3V	3718650	48.00	(1) CR123A 3V	High: 2 hours Low: 24 hours



NEW LED
25% BRIGHTER

NITRO

BRIGHTNESS 255 lumens **EFFECTIVE DISTANCE** 150 yards **FEATURES** Advanced digital circuitry delivers maximum light output using a single CR123A lithium battery • Luxeon® Rebel white LED plus two red and two green LEDs are rated for 100,000 hour service life • Lock-out switch with settings for high and low output • Battery operates to -40° F • Glass-fiber reinforced polycarbonate housing with aluminum lens ring • Silent Hinge minimizes unwanted noise • Includes headstrap in Vista® camo

CODE NUMBER	SUGGESTED RETAIL	BATTERIES	BATTERY LIFE
3718620	67.00	(1) CR123A Lithium	High: 2 hours Low: 24 hours

PRO HUNTER MAXUS

BRIGHTNESS 170 lumens **EFFECTIVE DISTANCE** 70 yards **FEATURES** Zoom lever adjusts the focus of the main LED from spot to flood • Powerful Cree® LED puts out 115 lumens for an effective range of 70 yards • Three light output levels (high, medium, low) and flash mode • Two green and two red LEDs offer maximum stealth, safety and help protect night vision • Maximum run time on low of 24 hours • Memory switch returns to the most recent setting when the light is turned on • Black front panel with charcoal accents

CODE NUMBER	SUGGESTED RETAIL	BATTERIES	BATTERY LIFE
3713329	49.00	(3) AAA Alkaline	High: 3.5 hours Low: 48 hours

NEW LED
50% BRIGHTER





MICROBLAST HEADLAMP

BRIGHTNESS 10 lumens **EFFECTIVE DISTANCE** 16 yards **FEATURES** Ultralight headlamp
 • Super bright yet so small it's unnoticed when worn • Two Nichia® white LEDs
 • One green LED • Rugged polymer construction with Silent Hinge • Headstrap for use as a headlamp • Clip to attach to a cap

CODE NUMBER	SUGGESTED RETAIL	BATTERIES	BATTERY LIFE
3712121	18.00	(2) 2032 Lithium	White: 5 hours Green: 33 hours



SUPER CAP LIGHT

BRIGHTNESS 80 lumens **EFFECTIVE DISTANCE** 60 yards **FEATURES** Our brightest cap light
 • Brighter than many flashlights • One white Cree® LED for distance and maximum brightness • Two Nichia LEDs for close-up illumination • 35 minute run time on high
 • 6 hour run time on low • Uses one AAA battery (included) • Clips to brim of hat with spring steel bail

CODE NUMBER	SUGGESTED RETAIL	BATTERIES	BATTERY LIFE
3715200	37.00	(1) AAA Alkaline	High: 35 minutes Low: 6 hours



A



B



C

NIGHT SEEKER CAP LIGHTS

BRIGHTNESS 15 to 20 lumens **EFFECTIVE DISTANCE** 22 to 40 yards **FEATURES** Our most popular cap lights with 1.5 million sold • Clip to the brim of a cap, on a pocket or pack strap or use as a freestanding light
 • Adjusts to aim the light where it's needed • Night Seeker RGB: Two white LEDs produce 15 lumens, plus red, green or blue from a center LED
 • Vista® camo clip • Night Seeker 2: Two white LEDs produce 19 lumens plus two green LEDs for stealth and better night vision • Night Seeker Pro: One white LED produces 20 lumens plus two green LEDs for stealth and night use

	MODEL	CODE NUMBER	SUGGESTED RETAIL	BATTERIES	BATTERY LIFE
A	Night Seeker RGB, Vista Camo on clip	3715100	18.00	(2) 2032 Lithium	White LEDs: 6.5 hours RGB LEDs: 15 hours
B	Night Seeker 2, Black	3715081	12.00	(2) 2032 Lithium	White LEDs: 10 hours Green LEDs: 48 hours
C	Night Seeker Pro, Black	3715099	22.00	(1) AAA Alkaline	0.5W White LED: 2 hours Green LEDs: 5 hours

NEW



A



B

NEW



C

NIGHT SEEKER 2 COMBOS

CAP LIGHT BRIGHTNESS 19 lumens **EFFECTIVE DISTANCE** 22 yards **FEATURES** Two white LEDs for general lighting • Two green LEDs for stealth and night use • Protected sliding switch prevents accidental activation in pocket or pack • Uses two 2032 batteries (included)
 • Clip adjusts to aim light where it's needed • Clip to the brim of a cap, on a pocket or a pack strap or use as a freestanding light **RUSS KOMMER DESIGNED KNIVES** Folding liner-lock with rugged aluminum handles • Razor-sharp 2-1/4" 440 stainless steel blade
 • Camo models features Dura-Touch Armor Coating • Thumbstud and pocket clip

	MODEL	CODE NUMBER	SUGGESTED RETAIL	BATTERIES	BATTERY LIFE
A	Black/Black	3715095	22.00	(2) 2032 Lithium	White LEDs: 10 hours Green LEDs: 48 hours
B	Vista/Vista	3715096	31.00	(2) 2032 Lithium	White LEDs: 10 hours Green LEDs: 48 hours
C	Black/Vista	3715098	24.00	(2) 2032 Lithium	White LEDs: 10 hours Green LEDs: 48 hours

DURA-TOUCH®
Armor Coating



MICROBLAST COMBO

FLASHLIGHT LENGTH 2-7/8" **BRIGHTNESS** 15 lumens **EFFECTIVE DISTANCE** 22 yards **FEATURES** 5mm LED is brighter than many two AA flashlights • Digital circuitry delivers maximum power using only one AAA battery • All aluminum body construction with unbreakable lens • O-ring sealed for water resistance • Deep Carry Pocket Clip™

MICROBLAST KNIFE Folding knife with durable frame lock • 2" stainless steel blade holds a sharp edge

CODE NUMBER	SUGGESTED RETAIL	BATTERIES	BATTERY LIFE
3712118	31.00	(1) AAA Alkaline	7 hours



NEW

4-IN-1 SURVIVAL PEN

BRIGHTNESS 12 lumens **EFFECTIVE DISTANCE** 22 yards **FEATURES** Innovative combination of flashlight, cap light, writing pen and a tactical glass breaker with hardened tungsten carbide point • Elegant yet rugged all-aluminum construction • 100,000 hour white LED • 8 hour run time • Lock on/lock off twist switch • Pocket clip • Uses four LR41 button batteries • Cap shown not included

CODE NUMBER	SUGGESTED RETAIL	BATTERIES	BATTERY LIFE
3712130	22.00	(4) LR41 Button	8 hours



NEW

MICROBLAST PEN LIGHTS

BRIGHTNESS Standard: 40 lumens • Slim: 22 Lumens **EFFECTIVE DISTANCE** Standard: 40 yards • Slim: 22 yards **FEATURES** Rugged all-aluminum construction • Heavy-duty pocket clip • Clear plastic bore light adaptor included • Standard model is completely redesigned for 2015 • Uses two AAA batteries • Four to 10 times brighter than many other pen lights • Slim model uses three AAAA batteries • Covert Cover on Slim model makes the light unseen from the side

	MODEL	CODE NUMBER	SUGGESTED RETAIL	BATTERIES	BATTERY LIFE
A	Slim with Bore Light Adaptor	3712120	22.00	(3) AAAA Alkaline	35 hours
B	Standard with Bore Light Adaptor	3712123	22.00	(2) AAA Alkaline	2-1/2 hours



NEW

CHOKE TUBE KEYCHAIN LIGHTS

BRIGHTNESS 12 lumens **EFFECTIVE DISTANCE** 22 yards **FEATURES** Nichia® high intensity white LED • O-ring sealed for water-resistance • Rugged aircraft grade aluminum construction • Twist switch for easy on and off • Includes four LR41 batteries • Up to 8 hours of continuous run time • Metal snap clip

	MODEL	CODE NUMBER	SUGGESTED RETAIL	BATTERIES	BATTERY LIFE
A	Midas, Black/Gold	N/A	12.00	(4) LR41	8 hours
B	Goose Band, Silver/ Black	N/A	12.00	(4) LR41	8 hours
C	Full Strut, Black/Camo	N/A	12.00	(4) LR41	8 hours

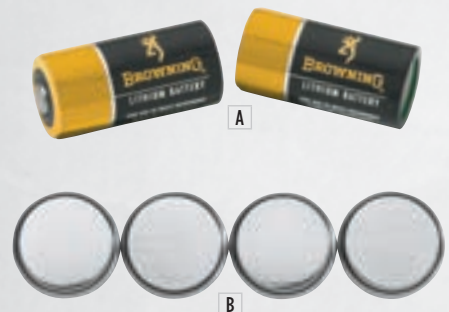

BATTERIES

CR123A: Packed two per blister card • Used in Blackout, Catalyst, Epic 3V, Nitro and in several models of Black Label tactical lights **2032:** Packed four per blister card • Used in Night Seeker 2 Cap Lights and many popular red-dot electronic sights

	MODEL	CODE NUMBER	SUGGESTED RETAIL
A	CR123A Batteries (2-Pack)	3742000	7.00
B	2032 Batteries (4-Pack)	3742100	6.00



WELCOME TO MOSSY OAK COUNTRY.



Country means something a little different to everyone. It might be the music you listen to. Maybe it's a location anywhere except the city. Maybe country is a way of life that is just a whole lot more easygoing.

The folks at Mossy Oak see country as being all those things and more. They think of country as a lifestyle, one in which hunting and spending time in the great outdoors is a big part. They know that time outdoors is family time, and that is time well spent. This is why we are proud to introduce Mossy Oak's all new Break-Up Country® camouflage pattern.

Break-Up Country is the first camo pattern ever that utilizes true-to-life size elements, unmatched digital clarity and accuracy to conceal your outline anywhere and in any season you hunt. In Break-Up Country, the elements are larger and more sparse to prevent the muddy darkness of other patterns. All the elements are actual objects, precisely represented in a digital format for unmatched realism and concealment. The leaf you see is a picture of a leaf, not just an artist's rendition.

When you remove all the technical jargon, Mossy Oak Break-Up Country is more than just another camo pattern, at its core, it's the country life itself.

Welcome to Break-Up Country.

BREAK-UP
COUNTRY

The logo for Mossy Oak Break-Up Country, featuring the words "BREAK-UP" in a small, bold, sans-serif font above the word "COUNTRY" in a large, bold, serif font. Below the text is a stylized graphic of a tree and a deer head.

ONE BRAND, THREE GREAT CHOICES FOR TECHNICAL CLOTHING.

Whether it is for season, performance or price, hunters demand different things from their clothing and no other company covers the broad spectrum of technical outerwear better than we do. At the top rung is XM Elite, built to ensure that the hardest of the hardcore big game hunters stay warm, dry and comfortable. Hell's Canyon strikes the perfect balance between value and performance by offering a ton of both. Wasatch rounds things out with rugged, no-frills gear at a huge value. Whether you demand the best gear or the best bang for your buck, look to one proven brand — Browning.



XM ELITE — UNCOMPROMISING PERFORMANCE.

If you leave nothing to chance, there is Browning XM Elite. Built with premium fabrications, XM Elite is the warmest, highest quality technical outerwear we build. It offers maximum performance in adverse weather conditions and yields superior comfort when moving. Premium Browning Pre-Vent fabric is both rugged and quiet, and fully-taped seams ensure 100% waterproof, windproof and breathable capabilities. The PrimaLoft® insulation used in XM Elite offers the highest insulation value of any of our outerwear and is the only place in our line-up where you will find the new super-warm PrimaLoft Down. In addition to premium materials, XM Elite adds functional touches hunters will appreciate.



HELL'S CANYON — SEE YOU THERE.

For tough, all-conditions gear, look no further than Browning Hell's Canyon. This versatile line-up includes everything from base layers to waterproof, insulated parkas and bibs, all made to keep you warm and dry from warmer to the worst conditions. Bowhunters will appreciate features like ADVANCED SCENT CONTROL to help hide from game and Harness Access which hides a treestand safety harness underneath the jacket. Browning Hell's Canyon fabrics offer the tough performance the name implies with high resistance to abrasion without sacrificing quietness. PrimaLoft® insulation provides an excellent warmth-to-weight ratio. For the ladies, Hell's Belles brings hardcore hunting gear with excellent protection to outdoorswomen.



WASATCH — BLURRING PERFORMANCE AND VALUE.

Wasatch does one thing and does it well — it gets the job done at a price that is tough to beat. Rugged Soft Shell gear offers windproof, breathable and water-resistant protection perfect for the majority of hunting conditions, while insulated rainwear offers true waterproof outerwear at a great price. Insulation layers range from warm, quiet fleece to stylish hoodies that are ideal for both the woods and downtown. Fieldwear options include the cotton/polyester pieces that made Wasatch famous, plus Mesh-Lite that is perfect for summer bowhunting and sitting around a water tank during dove season. Ladies and youth will both find designs that are comfortable, stylish and rugged.



PRE-VENT — SUPERIOR WATERPROOF, WINDPROOF AND BREATHABLE FABRICS.

- Pre-Vent is our waterproof, windproof, breathable fabric.
- Pre-Vent keeps out rain, snow and wind while breathing away perspiration to keep hunters warmer and drier.

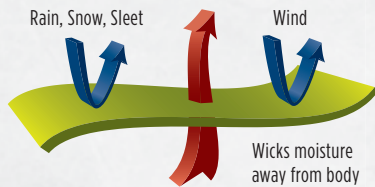

PRIMALOFT® IS WARM, WHETHER IT'S WET OR DRY.

- Primaloft is a premium performance insulation engineered for superior warmth, water-resistance, loft and compressibility.
- Primaloft fibers are densely packed and retain heat better than other insulations for improved thermal efficiency.
- Primaloft fibers are treated to repel water and absorb less water, making it more water-resistant and faster drying than other polyester insulations.
- Primaloft fibers are tightly compressed for improved wind-resistance, less bulk and extreme compression.
- The fine-fiber, high-loft insulation keeps hunters warmer, in extreme conditions — even if it gets wet.
- Primaloft is so good, it was chosen by the U.S. Military. Over 1,000,000 Primaloft military garments are deployed in active service around the world.

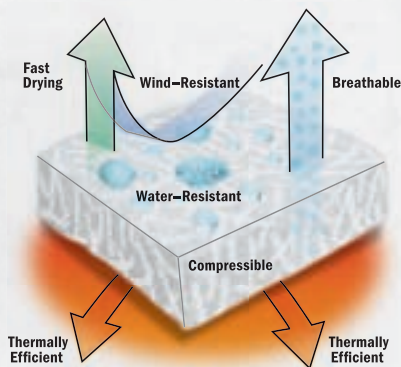

JUNIOR SIZING CHART

Kid's caps: 6-1/2", fits ages 18 months to 3 years old. Youth caps: 6-7/8", fits ages 4-9.

	S		M		L		XL	
	6	8	10	12	14	16	18	20
Height	45-48	49-52	53	58	59	63	66-1/2	68-1/2
Chest	26	27	28	30	31	33	35	36-1/2
Waist	22-1/2	23-1/2	24	25	26	27	29	30
Hip	27	28	30	32	33	34	34	35-1/2

MEN'S SIZING CHART

Every garment is designed and built to the specifications on the charts below. Offered in 3XL sizes in many styles, which are cut larger throughout.

	S	M	L	XL	2XL	3XL
Neck	14 to 14-1/2	15 to 15-1/2	16 to 16-1/2	17 to 17-1/2	18 to 18-1/2	18 to 19-1/2
Sleeve	32-33	33-34	34-35	35-36	36-37	36-37
Chest	37-39	40-42	43-45	46-48	49-51	52-54
Waist	28-31	32-35	36-39	40-43	44-46	47-49



HUNTERS HAVE THE ADVANTAGE: BROWNING'S TWO PRONGED ATTACK ON HUMAN ODOR.

As long as hunters have headed into the field, they have worked hard to outwit the keen noses of wary game. To combat human odor, we are introducing two-level protection with new **ADVANCED SCENT CONTROL**. **ADVANCED** is the next generation of scent control and revolutionizes this critical aspect of hunting. Rather than relying on stiffening carbon technology, **ADVANCED** uses two level technology to first attack the bacteria that causes human odors. Secondly, it captures human scent before it escapes into the air. This one-two punch helps control detectable human scent, regenerates with every wash/dry cycle, lasts for the life of the garment and adds no noticeable weight or stiffness. The result is that hunters can go undetected longer and get closer than ever before for a perfect well-placed shot.

ADVANCED SCENT CONTROL

- Attacks bacteria that causes human odors.
- Captures human scent before it can escape into the environment.
- Recharges easily.
- Lasts for the life of the garment.
- Adds no noticeable weight or stiffness.



ODORSMART™

CONTROLS ODOR AT THE START.

- Human odor is caused by bacteria that thrive on the skin. The bacteria's waste produces odors that are detected by deer and other big game animals.
- OdorSmart attacks bacteria in the microclimate around the skin, helping to kill the bacteria before odors develop.
- OdorSmart lasts the life of the garment with normal care, and does not require recharging or special cleansers. Just wash OdorSmart items as instructed on the care label.



HARNES ACCESS ON SELECT HELL'S CANYON OUTERWEAR.

- Select Browning Hell's Canyon outerwear now offers Harness Access.
- Allows a treestand safety harness to be comfortably worn underneath a parka or jacket.
- Improves concealment as the harness no longer interferes with the camouflage pattern on the garment.
- Easy access to pockets.

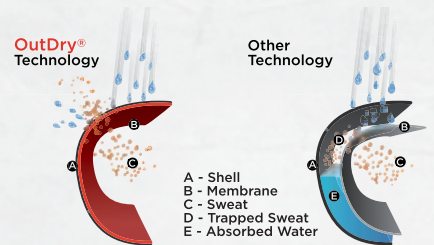

NO MORE COLD, WET HANDS.

- Cold, wet hands are often caused when cold water is trapped between the outer shell of the glove and the waterproof liner. It's like inserting a small plastic bag inside a larger bag, then filling the space between the two bags with ice water. Hands stay dry, but they are still cold.
- The OutDry® membrane is laminated to the inside surface of the fabric shell and eliminates the space between the shell and liner, leaving no place for cold water to collect.
- This unique construction offers a sleek fit with improved finger dexterity and eliminates torn or loose fitting liners.
- When combined with Primaloft® insulation hunters get the benefit of even more warmth.



WHAT FIT TO CHOOSE?

- Our outerwear is divided into Athletic Cut and Regular Cut.
- Athletic Cut provides a trimmer, tailored fit with reduced bulk. Athletic Cut garments move comfortably with the wearer with less snagging on brush.
- Athletic Cut is cut straight, or slightly tapered, from the shoulders to the hips. For those who don't exactly fit this body shape, a larger size can be chosen.
- Regular Cut is a traditional, full cut design that offers maximum freedom of movement.
- Regular Cut is tailored for a wide variety of body shapes with a fuller fit. Larger hunters, or those who just want a little extra room will prefer this fit.



KILL CHILL WITH WINDKILL.

- Our windproof, breathable WindKill fabric is 100% windproof, highly breathable and water resistant.
- A lightweight barrier, WindKill prevents chilling winds from penetrating the fabric to keep hunters warm.

HELL'S BELLES AND FOR HER SIZING CHART

	S		M		L		XL		2XL
	4	6	8	10	12	14	16	18	
Neck	11-1/2	12-1/2	12-1/2	13-1/2	13-1/2	14-1/2	14-1/2	15-1/2	15-1/2
Sleeve	30	30	31	31	32	32	33	33	34
Bust	33-1/2	34-1/2	35-1/2	36-1/2	38	39-1/2	41	43	45
Waist	25-1/2	26-1/2	27-1/2	28-1/2	30	31-1/2	33	35	37
Hip	35-1/2	36-1/2	37-1/2	38-1/2	40	41-1/2	43	45	47
Inseam	30	30	30	30	32	32	32	32	32

MEN'S GLOVE SIZING CHART

Measure around the flat of the hand just below the knuckles, excluding the thumb. Number of inches around hand equals glove size.

XS	S	M	L	XL
7 to 7-1/2	8 to 8-1/2	9 to 9-1/2	10 to 10-1/2	11 to 11-1/2

XM ELITE SOFT SHELL

Lightweight Pre-Vent shell fabric is 100% waterproof/windproof/breathable • Taped seams prevent water entry • Articulated patterning provides comfort and additional freedom of movement • Athletic Cut **JACKET** Attached hood is fully adjustable for complete protection from the elements • Elasticized, hook and loop adjustable cuffs seal out water and wind • Underarm pit-zips provide ventilation to breathe away perspiration • Welded chest pocket with laminated zipper closure • Two large handwarmer pockets with laminated zipper closures • All pocket zippers have garages to prevent water entry • Internal storm flap with fleece lined beard guard • Drop-back bottom hem with drawcord seals in warm air and prevents drafts • Corded zipper pulls reduce noise and are easy to grab even with gloves on • License tab on back doesn't sacrifice waterproofness **PANT** Fully constructed waist with zippered fly, belt loops and no-slip rubberized strip • Hip pockets with waterproof zipper closures • Oversize pocket with waterproof zipper closure on right thigh • Open cuffs with zip-to-knee opening and waterproof zipper for easy on/off



DESCRIPTION	CODE NUMBER	SUGGESTED RETAIL	SIZE
JACKET (SHOWN IN REALTREE XTRA)			
Mossy Oak Break-Up Country	30473728	330.00	S-XL
		350.00	2XL-3XL
Realtree Xtra	30473724	330.00	S-XL
		350.00	2XL-3XL
PANT (SHOWN IN REALTREE XTRA)			
Mossy Oak Break-Up Country	30273728	312.00	S-XL
		330.00	2XL-3XL
Realtree Xtra	30273724	312.00	S-XL
		330.00	2XL-3XL

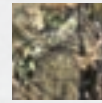

Mossy Oak Break-Up Country

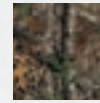

Realtree Xtra



NEW

XM ELITE PRIMALOFT® RAIN GEAR

Pre-Vent shell fabric is 100% waterproof/windproof/breathable • Taped seams prevent water entry • Articulated patterning provides comfort and additional freedom of movement • Generously insulated with Primaloft® insulation for maximum warmth with minimal weight and bulk • Smooth lining is quilted to stabilize insulation and prevent cold spots • Athletic Cut **RAIN PARKA** Sleeves feature internal cuffs to block drafts • All external pocket zippers have garages or pocket flaps to prevent water entry • Full-length YKK® front zipper • Internal storm flap with fleece lined beard guard • Fully adjustable, detachable hood for complete protection from the elements • Two large, easily accessible chest pockets with zipper closures and pocket flap • Two large handwarmer pockets with laminated zipper closures • Internal zippered security pocket for valuables • Drop-back bottom hem with drawcord seals in warm air and prevents drafts • Articulated patterning provides comfort and additional freedom of movement • Corded zipper pulls reduce noise and are easy to grab even with gloves on • License tab on back doesn't sacrifice waterproofness **RAIN BIB** Full-length front zipper closure for easy on/off • Quick release elastic suspenders • Hip pockets with reinforced knife patch • Full-length two-way side seam zippers for easy on/off and ventilation



DESCRIPTION	CODE NUMBER	SUGGESTED RETAIL	SIZE
RAIN PARKA (SHOWN IN REALTREE XTRA)			
Mossy Oak Break-Up Country	30373628	360.00	S-XL
		380.00	2XL-3XL
Realtree Xtra	30373624	360.00	S-XL
		380.00	2XL-3XL
RAIN BIB (SHOWN IN REALTREE XTRA)			
Mossy Oak Break-Up Country	30673628	330.00	S-XL
		360.00	2XL-3XL
Realtree Xtra	30673624	330.00	S-XL
		360.00	2XL-3XL

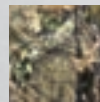

Mossy Oak Break-Up Country

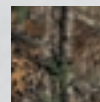

Realtree Xtra



NEW

DOWN HAS MET ITS MATCH.

Combine the proven characteristics of down with modern technology and you have the perfect insulation layer. The new PrimaLoft® Down jacket combines down with advanced synthetic PrimaLoft fibers to keep hunters warmer, longer, even when wet.

XM ELITE PRIMALOFT® DOWN JACKET

Ultralight shell and lining fabrics • PrimaLoft® Down offers high warmth-to-weight ratio and dries significantly faster than untreated down • Innovative quilting concentrates down in areas critical for warmth • Full-length front zipper closure • Welded left chest pocket with zipper closure • Right chest pocket with zipper closure • Drawcord adjustable bottom and Lycra® cuffs prevent drafts • Handwarmer pockets with zipper closures • Athletic Cut

NEW



PRIMALOFT® DOWN

For the ultimate in warmth in varying conditions, look no further than PrimaLoft® Down. As the world's first hybrid of premium down (60%) and ultra-fine PrimaLoft synthetic fibers (40%) this innovative blend creates a lightweight, yet warm insulation that keeps the wearer warmer when wet, than down alone. PrimaLoft synthetic insulation has built a reputation for water-resistant insulations, and tests have shown that the new PrimaLoft Down retains an incredible 94% of warmth when wet, absorbs nine times less water and dries four times faster than pure down. And PrimaLoft Down retains its performance wash after wash, showing excellent property retention after more than 10 launderings.

	DESCRIPTION	CODE NUMBER	SUGGESTED RETAIL	SIZE
A	Mossy Oak Break-Up Country	30473828	240.00	S-XL
	Realtree Xtra	30473824	270.00	2XL-3XL
			240.00	S-XL
B	Tan	30473832	270.00	2XL-3XL
			215.00	S-XL
			240.00	2XL-3XL

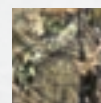

Mossy Oak Break-Up Country

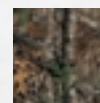

Realtree Xtra

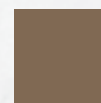

Tan



ATHLETIC CUT



MOSSY OAK



PRIMALOFT



REALTREE

NEW



HELL'S CANYON SOFT SHELL

Midweight 3-layer shell fabric is windproof, water-resistant and breathable • Soft fleece lining features revolutionary **ADVANCED SCENT CONTROL** to significantly reduce human scent • Articulated patterning provides comfort and additional freedom of movement • Athletic Cut **JACKET** Harness Access opening on the back allows the jacket to be worn over a treestand safety harness • Stretch nylon adjustable cuffs with hook and loop closures eliminate drafts and prevent water entry • Underarm pit-zips provide ventilation to breathe away perspiration • Sleeves are lined for easy on/off and additional freedom of motion • Two mesh-lined chest pockets with zipper closures • Two mesh-lined handwarmer pockets with zipper closures • External pocket zippers have garages to prevent water entry • Drop-back bottom hem with drawcord seals in warm air and prevents drafts • Corded zipper pulls reduce noise and are easy to grab even with gloves on **PANT** Fully constructed waist with zippered fly, belt loops and no-slip rubberized strip • Hip pockets with reinforced overlay for knife clip • One pocket on each thigh for carrying gear • One rear pocket with zipper closure and storm flap • Side seam ventilation zippers on the hips • Open cuffs with zip-to-knee opening for easy on/off • Articulated knees for comfort



DESCRIPTION	CODE NUMBER	SUGGESTED RETAIL	SIZE
JACKET (SHOWN IN REALTREE XTRA)			
Mossy Oak Break-Up Country	30458128	240.00	S-XL
		250.00	2XL-3XL
Realtree Xtra	30458124	240.00	S-XL
		250.00	2XL-3XL
PANT (SHOWN IN MOSSY OAK BREAK-UP COUNTRY)			
Mossy Oak Break-Up Country	30258128	225.00	S-XL
		240.00	2XL-3XL
Realtree Xtra	30258124	225.00	S-XL
		240.00	2XL-3XL

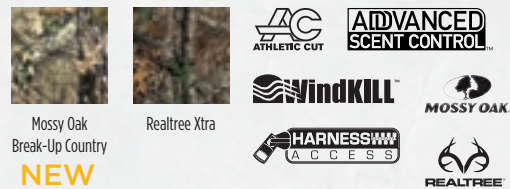

HELL'S BELLES SOFT SHELL

Midweight 3-layer shell fabric is windproof, water-resistant and breathable • Soft fleece lining features revolutionary **ADVANCED SCENT CONTROL** to significantly reduce human scent • Pink contrast (Patent Pending) • Women's contoured fit **JACKET** Stretch nylon adjustable cuffs with hook and loop closures eliminate drafts and prevent water entry • Two mesh-lined handwarmer pockets with zipper closures • Zippered pocket on left sleeve • Drop-back bottom hem with drawcord seals in warm air and prevents drafts • Corded zipper pulls reduce noise and are easy to grab even with gloves on **PANT** Fully constructed waist with zippered fly, belt loops and no-slip rubberized strip • Hip pockets • Thigh pocket on right leg carries loads of gear • One rear pocket with zipper closure • Open cuffs with zip-to-knee opening for easy on/off



DESCRIPTION	CODE NUMBER	SUGGESTED RETAIL	SIZE
JACKET (SHOWN IN REALTREE XTRA/REALTREE PINK)			
Mossy Oak Break-Up Country/Mossy Oak Pink	30461028	212.00	S-2XL
Realtree Xtra/Realtree Pink	30461024	212.00	S-2XL
PANT (SHOWN IN REALTREE XTRA/REALTREE PINK)			
Mossy Oak Break-Up Country/Mossy Oak Pink	30261028	200.00	S-2XL
Realtree Xtra/Realtree Pink	30261024	200.00	S-2XL

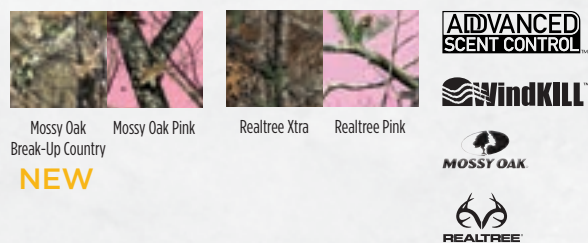



HELL'S CANYON ULTRA-LITE

Lightweight 2-Layer shell fabric is wind- and water-resistant and highly breathable • Soft fleece lining features revolutionary **ADVANCED SCENT CONTROL** to significantly reduce human scent • Articulated patterning provides comfort and additional freedom of movement • Athletic Cut **JACKET** Harness Access opening on the back allows the jacket to be worn over a treestand safety harness • Stretch internal cuffs eliminate drafts • Sleeves are lined for easy on/off and additional freedom of motion • Two oversize pockets with zipper closures and zipper garages prevent water entry • Drop-back bottom hem with drawcord seals in warm air and prevents drafts • Corded zipper pulls reduce noise **1/4 ZIP TOP** Performance Fleece side and sleeve panels provide additional ventilation • Zippered neck opening for ventilation and easy on/off • Welded chest pocket with zippered opening • Lycra® cuffs and bottom hem retain warmth and block out the cold • Corded zipper pulls reduce noise • External pocket zipper has a garage to prevent water entry **PANT** Fully constructed waist with zippered fly, belt loops and no-slip rubberized strip • Hip pockets with reinforced overlays for knife clip • Thigh pockets with zipper closures • One rear pocket with zipper closure • Open cuffs with zip-to-knee opening for easy on/off • Articulated knees for comfort



DESCRIPTION	CODE NUMBER	SUGGESTED RETAIL	SIZE
JACKET (SHOWN IN REALTREE MAX-1)			
Mossy Oak Break-Up Country	30458228	200.00	S-XL
		212.00	2XL-3XL
Realtree Xtra	30458224	200.00	S-XL
		212.00	2XL-3XL
Realtree Max-1	30458223	200.00	S-XL
		212.00	2XL-3XL
1/4 ZIP TOP (SHOWN IN MOSSY OAK BREAK-UP COUNTRY)			
Mossy Oak Break-Up Country	30458328	173.00	S-XL
		186.00	2XL-3XL
Realtree Xtra	30458324	173.00	S-XL
		186.00	2XL-3XL
Realtree Max-1	30458323	173.00	S-XL
		186.00	2XL-3XL
PANT (SHOWN IN REALTREE XTRA)			
Mossy Oak Break-Up Country	30258228	200.00	S-XL
		212.00	2XL-3XL
Realtree Xtra	30258224	200.00	S-XL
		212.00	2XL-3XL
Realtree Max-1	30258223	200.00	S-XL
		212.00	2XL-3XL

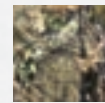

Mossy Oak Break-Up Country

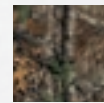

Realtree Xtra

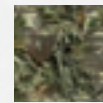

Realtree Max-1



NEW

HELL'S BELLES ULTRA-LITE

Lightweight 2-Layer shell fabric is wind- and water-resistant and highly breathable • Soft fleece lining features revolutionary **ADVANCED SCENT CONTROL** to significantly reduce human scent • Articulated patterning provides comfort and additional freedom of movement • Pink camo contrast (Patent Pending) • Women's contoured fit **JACKET** Stretch internal cuffs eliminate drafts • Sleeves are lined for easy on/off and additional freedom of motion • Two handwarmer pockets with zipper closures • Drop-back bottom hem with drawcord seals in warm air and prevents drafts • Corded zipper pulls reduce noise **PANT** Elasticized waist with drawcord and belt loops • Two fleece-lined hip pockets • One rear pocket with zipper closure • Open cuffs with zip-to-knee opening for easy on/off



DESCRIPTION	CODE NUMBER	SUGGESTED RETAIL	SIZE
JACKET (SHOWN IN MOSSY OAK BREAK-UP COUNTRY/ MOSSY OAK PINK)			
Mossy Oak Break-Up Country/Mossy Oak Pink	30461128	173.00	S-2XL
		173.00	S-2XL
Realtree Xtra/Realtree Pink	30461124	173.00	S-2XL
		173.00	S-2XL
PANT (SHOWN IN REALTREE XTRA/REALTREE PINK)			
Mossy Oak Break-Up Country/Mossy Oak Pink	30261128	173.00	S-2XL
		173.00	S-2XL
Realtree Xtra/Realtree Pink	30261124	173.00	S-2XL
		173.00	S-2XL

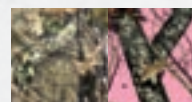

Mossy Oak Break-Up Country

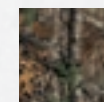

Mossy Oak Pink

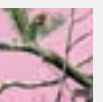

Realtree Xtra



NEW



HELL'S CANYON PRIMALOFT® 4-IN-1 PARKA AND BIB

Quiet Pre-Vent shell fabric is waterproof, windproof and breathable • All seams are taped for 100% waterproof protection • Lightweight, lofty Primaloft® insulation provides unequalled warmth for its weight • All external pocket zippers have garages or pocket flaps to prevent water entry • Articulated patterning for great fit and freedom of movement • Regular Cut **4-IN-1 PARKA** Mesh lining in upper body and taffeta in lower body and sleeves • Detachable hood is fully adjustable for complete protection from the elements • Two large, easily accessible chest pockets with zipper closures • Two large bellows pockets with zipper closures • Handwarmer pockets behind bellows pockets • Internal zippered security pocket for valuables • Underarm gussets provide unrestricted arm movement • Full-length YKK® AquaGuard® front closure with laminated internal zipper flap to prevent water entry • Waist drawcord seals in warm air and prevents drafts • License tab on back doesn't sacrifice waterproofness • Primaloft liner has a highly water- and wind-resistant shell fabric that reverses to solid color **BIB** Lightweight, lofty Primaloft insulation provides unequalled warmth for its weight • Low-front design eliminates bulk when worn with matching parka • Elasticized suspenders and waist allow for a perfect fit and great comfort • Two hip pockets with waterproof zipper closures • One rear zippered pocket • Full-length side seam zippers extend from cuff to thigh for easy on/off • One rear pocket with zipper closure **GLOVE** Revolutionary OutDry® membrane lamination process for 100% waterproof protection • Primaloft insulation • Elasticized wrist for snug fit • Overlay on palm, thumb and fingers • Articulated pre-curved fingers • Hook and loop cuff closure



DESCRIPTION	CODE NUMBER	SUGGESTED RETAIL	SIZE
4-IN-1 PARKA (SHOWN IN REALTREE XTRA)			
Mossy Oak Break-Up Country	30358628	400.00	S-XL
		440.00	2XL-3XL
Realtree Xtra	30358624	400.00	S-XL
		440.00	2XL-3XL
PRIMALOFT OUTDRY GLOVE (SHOWN IN REALTREE XTRA)			
Mossy Oak Break-Up Country	30780028	120.00	S-XL
Realtree Xtra	30780024	120.00	S-XL
BIB (SHOWN IN MOSSY OAK BREAK-UP COUNTRY)			
Mossy Oak Break-Up Country	30658628	290.00	S-XL
		300.00	2XL-3XL
Realtree Xtra	30658624	290.00	S-XL
		300.00	2XL-3XL

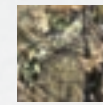

Mossy Oak Break-Up Country

NEW

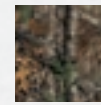

Realtree Xtra



HELL'S CANYON PACKABLE RAIN WEAR

Quiet ultralight Pre-Vent shell fabric is waterproof, windproof and breathable • All seams are taped for 100% waterproof protection • Compresses into provided compact stuff bag • Regular Cut **JACKET** Attached hood is fully adjustable for complete protection from the elements • Elasticized hook and loop adjustable cuffs prevent water entry • Drop-back bottom hem with drawcord seals in warm air and prevents drafts • Upper chest pocket and two handwarmer pockets feature laminated waterproof zippers and zipper garages to prevent water entry • Articulated patterning provide great fit and freedom of movement • License tab on back doesn't sacrifice waterproofness • Full-length YKK® AquaGuard® zippered front closure • Laminated internal storm flap prevent water entry and fleece lined beard guard provides extra comfort **PANT** Elasticized waist with drawcord for easy on/off • Zippered fly • Rear pocket with hook and loop closure • Open cuffs with zip-to-knee opening for easy on/off



DESCRIPTION	CODE NUMBER	SUGGESTED RETAIL	SIZE
JACKET (SHOWN IN REALTREE XTRA)			
Mossy Oak Break-Up Country	30458528	250.00	S-XL
		275.00	2XL-3XL
Realtree Xtra	30458524	250.00	S-XL
		275.00	2XL-3XL
PANT (SHOWN IN REALTREE XTRA)			
Mossy Oak Break-Up Country	30258528	200.00	S-XL
		212.00	2XL-3XL
Realtree Xtra	30258524	200.00	S-XL
		212.00	2XL-3XL

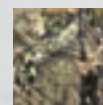

Mossy Oak Break-Up Country

NEW

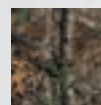

Realtree Xtra





ULTRA-LITE, ULTRA-WARM.

If down insulation has a single drawback, it would be performance when it gets wet. While synthetic insulations fare better, they can't match the overall performance of pure down. The solution was simple: Blended down. By combining premium down with water-resistant synthetic insulation, a more dynamic garment was created, one that keeps hunters warmer in all conditions — even if it gets wet.

HELL'S CANYON BLENDED DOWN JACKET • HELL'S BELLES BLENDED DOWN JACKET

New blended down insulation offers maximum warmth and water-resistance • Highly constructed shell fabric is wind- and water-resistant • Full-length front zipper closure with internal flap to block drafts • Handwarmer pockets with zipper closures • Inside pocket with zipper closure for valuables • Drop back bottom hem and drawcord seals in warm air and keeps out cold • Elasticized cuff closures for added protection from the elements • Stuffs into provided stuff sack for easy storage • Athletic Cut • Hell's Belles has a women's contoured fit



DESCRIPTION	CODE NUMBER	SUGGESTED RETAIL	SIZE
JACKET (SHOWN IN BLACK)			
Mossy Oak Break-Up Country	30473928	215.00	S-XL
		225.00	2XL-3XL
Realtree Xtra	30473924	215.00	S-XL
		225.00	2XL-3XL
Black	30473990	200.00	S-XL
		215.00	2XL-3XL
HELL'S BELLES JACKET (SHOWN IN REALTREE XTRA)			
Mossy Oak Break-Up Country	30461828	200.00	S-2XL
Realtree Xtra	30461824	200.00	S-2XL
Black	30461890	187.00	S-2XL

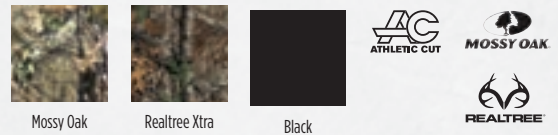

NEW

HELL'S CANYON PRIMALOFT® JACKET • HELL'S BELLES PRIMALOFT® JACKET

Featherweight shell fabric is highly water- and wind-resistant • Lightweight Primaloft® insulation throughout assures ultimate lightweight warmth and comfort • Two handwarmer pockets with zipper closures • Inside zippered pocket for valuables • Hell's Canyon has one chest pocket • Drop back bottom hem and drawcord seals in warm air and keeps out cold • Lycra® cuff closures for added protection from the elements • Stuffs into provided stuff sack for easy storage • Full-length front zipper closure with internal flap to block wind and rain • Articulated patterning for great fit and freedom of movement • Athletic Cut • Hell's Belles has a women's contoured fit



DESCRIPTION	CODE NUMBER	SUGGESTED RETAIL	SIZE
JACKET (SHOWN IN REALTREE XTRA)			
Mossy Oak Break-Up Country	30458728	225.00	S-XL
		240.00	2XL-3XL
Realtree Xtra	30458724	225.00	S-XL
		240.00	2XL-3XL
HELL'S BELLES JACKET (SHOWN IN REALTREE XTRA/REALTREE PINK)			
Mossy Oak Break-Up Country/Mossy Oak Pink	30461228	212.00	S-2XL
Realtree Xtra/Realtree Pink	30431224	212.00	S-2XL

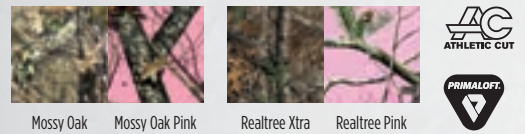

NEW



HELL'S CANYON PERFORMANCE FLEECE 1/4 ZIP JACKET

Warm performance fleece construction • Zippered neck opening for ventilation and easy on/off
 • Knit cuffs with thumb hole bottom hem block out cold • Zippered chest pocket for valuables
 • Ideal as a layering or stand alone jacket • Athletic Cut

DESCRIPTION	CODE NUMBER	SUGGESTED RETAIL	SIZE
(SHOWN IN MOSSY OAK BREAK-UP COUNTRY)			
Mossy Oak Break-Up Country	30458428	170.00	S-XL
		180.00	2XL-3XL
Realtree Xtra	30458424	170.00	S-XL
		180.00	2XL-3XL

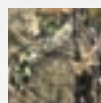

Mossy Oak Break-Up Country

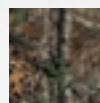

Realtree Xtra



NEW

HELL'S CANYON PERFORMANCE FLEECE HOODIE

Warm performance fleece construction • Classic hoodie design with kangaroo pocket and attached hood with drawcord • Knit cuffs with thumb hole bottom hem block out cold • Ideal as a layering or stand alone garment • Athletic Cut

DESCRIPTION	CODE NUMBER	SUGGESTED RETAIL	SIZE
(SHOWN IN REALTREE XTRA)			
Mossy Oak Break-Up Country	30158428	170.00	S-XL
		180.00	2XL-3XL
Realtree Xtra	30158424	170.00	S-XL
		180.00	2XL-3XL

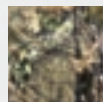

Mossy Oak Break-Up Country

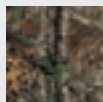

Realtree Xtra



NEW



HELL'S CANYON GLOVE • HELL'S CANYON BEANIE

GLOVE Wind- and water-resistant Hell's Canyon fabric throughout • Overlay on palm and thumb for firm grip • Conductive trigger finger works with touch screen electronics
 • Comfortable fleece cuffs for a snug fit **BEANIE** Four-way stretch fabric assures comfortable fit • Warm, comfortable lining • Easily stuffs away into pocket or pack

DESCRIPTION	CODE NUMBER	SUGGESTED RETAIL	SIZE
GLOVE (SHOWN IN REALTREE XTRA)			
Mossy Oak Break-Up Country	30780128	50.00	S-XL
Realtree Xtra	30780124	50.00	S-XL
BEANIE (SHOWN IN MOSSY OAK BREAK-UP COUNTRY)			
Mossy Oak Break-Up Country	30894128	44.00	One Size
Realtree Xtra	30894124	44.00	One Size

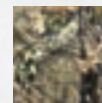

Mossy Oak Break-Up Country

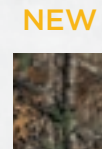

Realtree Xtra



NEW





HELL'S CANYON LIGHTWEIGHT BASE LAYER TOP

Lightweight 100% polyester fabric is perfect for both warm weather and layering • OdorSmart™ antimicrobial technology helps control the bacteria that causes human odors • Flatlock stitching for additional comfort • Crew neck • Athletic Cut

DESCRIPTION	CODE NUMBER	SUGGESTED RETAIL	SIZE
(SHOWN IN REALTREE XTRA)			
Mossy Oak Break-Up Country	30180328	66.00	S-XL
		73.00	2XL-3XL
Realtree Xtra	30180324	66.00	S-XL
		73.00	2XL-3XL
Realtree Max-1	30180323	66.00	S-XL
		73.00	2XL-3XL

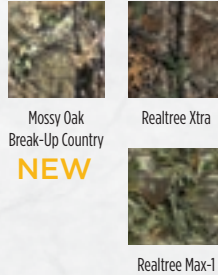

Mossy Oak Break-Up Country
NEW

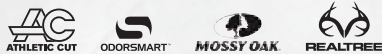

HELL'S CANYON MIDWEIGHT BASE LAYER 1/4 ZIP TOP • HELL'S CANYON MIDWEIGHT BASE LAYER MOCK NECK TOP

Midweight 100% polyester fabric is ideal for layering in cold conditions • Smooth face with fleece inner layer adds comfort and traps warm air next to the skin for additional warmth • OdorSmart™ antimicrobial technology helps control the bacteria that causes human odors • Flatlock stitching for additional comfort • Mock neck traps warmth • 1/4 zip collar offers additional ventilation • Athletic Cut



DESCRIPTION	CODE NUMBER	SUGGESTED RETAIL	SIZE
1/4 ZIP TOP (SHOWN IN REALTREE MAX-1)			
Mossy Oak Break-Up Country	30180528	66.00	S-XL
		73.00	2XL-3XL
Realtree Xtra	30180524	66.00	S-XL
		73.00	2XL-3XL
Realtree Max-1	30180523	66.00	S-XL
		73.00	2XL-3XL
MOCK NECK TOP (SHOWN IN REALTREE XTRA)			
Mossy Oak Break-Up Country	30180428	66.00	S-XL
		73.00	2XL-3XL
Realtree Xtra	30180424	66.00	S-XL
		73.00	2XL-3XL
Realtree Max-1	30180423	66.00	S-XL
		73.00	2XL-3XL

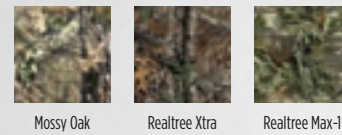

Mossy Oak Break-Up Country
NEW



HELL'S CANYON MIDWEIGHT BASE LAYER BOTTOM

Midweight 100% polyester fabric is ideal for layering in cold conditions • Smooth face with fleece inner layer adds comfort and traps warm air next to the skin for additional warmth • OdorSmart™ antimicrobial technology helps control the bacteria that causes human odors • Flatlock stitching for additional comfort • Fly opening • Elasticized waist • Athletic Cut

DESCRIPTION	CODE NUMBER	SUGGESTED RETAIL	SIZE
(SHOWN IN REALTREE XTRA)			
Mossy Oak Break-Up Country	30215828	53.00	S-XL
		59.00	2XL-3XL
Realtree Xtra	30215824	53.00	S-XL
		59.00	2XL-3XL
Realtree Max-1	30215823	53.00	S-XL
		59.00	2XL-3XL

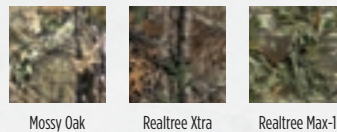

Mossy Oak Break-Up Country
NEW





WASATCH SOFT SHELL

Quiet, 3-Layer windproof, breathable, water-resistant fabric offers lasting performance **JACKET** Full-length front zipper • Zippered handwarmer pockets • Zippered chest pocket • Raglan sleeve design offers improved freedom of motion • Adjustable cuffs seal out drafts • Stand-up, zip-through collar **PANT** Two front pockets • Two rear zippered pockets • Two zippered cargo pockets • Belt loops • Zippered fly • Regular Cut



DESCRIPTION	CODE NUMBER	SUGGESTED RETAIL	SIZE
JACKET (SHOWN IN REALTREE XTRA)			
Mossy Oak Break-Up Country	30414128	123.00 138.00	S-XL 2XL-3XL
Realtree Xtra	30414124	123.00 138.00	S-XL 2XL-3XL
PANT (SHOWN IN REALTREE XTRA)			
Mossy Oak Break-Up Country	30213628	123.00 138.00	S-XL 2XL-3XL
Realtree Xtra	30213624	123.00 138.00	S-XL 2XL-3XL

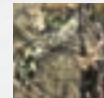

Mossy Oak Break-Up Country

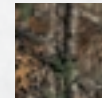

Realtree Xtra



NEW



WASATCH FLEECE JACKET

100% midweight polyester fleece is ideal as an insulation layer or outer layer in drier weather • Full-length front zipper • Zippered handwarmer pockets • Lycra® cuffs seal out drafts • Stand-up, zip-through collar • Regular Cut

DESCRIPTION	CODE NUMBER	SUGGESTED RETAIL	SIZE
Realtree Xtra	30413924	92.00 100.00	S-XL 2XL-3XL

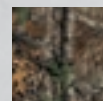

Realtree Xtra



WASATCH INSULATED RAIN WEAR

Quiet, 100% waterproof, breathable fabric • Fully taped seams offer total protection from moisture • Regular Cut **PARKA** Differential insulation places more insulation in the body for added warmth around the core and less in the sleeves for optimal freedom of motion • Lower bellows pockets with handwarmer pockets • Upper zippered slash pockets • Detachable hood with drawcord adjustment • Storm flap seals out wind and water • Adjustable cuffs • License tab **BIB** Fully insulated for excellent warmth • Zip-to-hip side openings with storm flaps slide easily over boots • Zippered front opening with storm flap • Comfortable elasticized suspenders • One front zippered pocket • Two lower zippered handwarmer pockets



DESCRIPTION	CODE NUMBER	SUGGESTED RETAIL	SIZE
PARKA (SHOWN IN REALTREE XTRA)			
Mossy Oak Break-Up Country	30313728	231.00 246.00	S-XL 2XL-3XL
Realtree Xtra	30313724	231.00 246.00	S-XL 2XL-3XL
BIB (SHOWN IN REALTREE XTRA)			
Mossy Oak Break-Up Country	30613728	231.00 246.00	S-XL 2XL-3XL
Realtree Xtra	30613724	231.00 246.00	S-XL 2XL-3XL

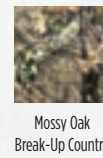

Mossy Oak Break-Up Country

NEW

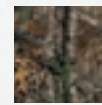

Realtree Xtra



REGULAR CUT



MOSSY OAK



REALTREE

JUNIOR WASATCH INSULATED RAIN WEAR

Quiet, 100% waterproof, breathable fabric • Fully taped seams offer total protection from moisture • Junior Cut **PARKA** Differential insulation places more insulation in the body for added warmth around the core and less in the sleeves for optimal freedom of motion • Lower bellows pockets with handwarmer pockets • Upper zippered slash pockets • Detachable hood with elastic strip • Storm flap seals out wind and water • Adjustable cuffs • License tab **BIB** Fully insulated for excellent warmth • Zip-to-hip side openings with storm flaps slide easily over boots • Zippered front opening with storm flap • Comfortable elasticized suspenders • One front zippered pocket • Two lower zippered handwarmer pockets



DESCRIPTION	CODE NUMBER	SUGGESTED RETAIL	SIZE
JUNIOR PARKA (SHOWN IN REALTREE XTRA)			
Mossy Oak Break-Up Country	30313828	154.00	S-XL
Realtree Xtra	30313824	154.00	S-XL
JUNIOR BIB (SHOWN IN REALTREE XTRA)			
Mossy Oak Break-Up Country	30613828	154.00	S-XL
Realtree Xtra	30613824	154.00	S-XL

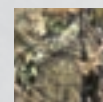

Mossy Oak Break-Up Country

NEW

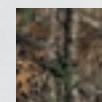

Realtree Xtra



MOSSY OAK



REALTREE



WASATCH SHIRT

7 oz., 55% cotton/45% polyester twill fabric • Seven-button front with long tails • Double pleated back for full range of motion • Button-down collar • Double-needle side seam construction • Adjustable button cuffs and longer sleeve plackets for easier roll-up • Regular Cut



	DESCRIPTION	CODE NUMBER	SUGGESTED RETAIL	SIZE
	Mossy Oak Shadow Grass Blades	30113525	48.00	S-XL
			56.00	2XL-3XL
A	Mossy Oak Break-Up Country	30113528	48.00	S-XL
			56.00	2XL-3XL
B	Mossy Oak Bottomland	30113519	48.00	S-XL
			56.00	2XL-3XL
	Realtree Max-5	30113576	48.00	S-XL
			56.00	2XL-3XL
	Realtree Max-1	30113523	48.00	S-XL
			56.00	2XL-3XL
C	Realtree Xtra	30113524	48.00	S-XL
			56.00	2XL-3XL



WASATCH PANT

7 oz., 55% cotton/45% polyester twill • Deep front pockets • Oversized side cargo pockets with flap and button closure • Drawcord cuffs for snug fit around boots • Adjustable waist tabs for comfortable fit • Rear flap button-through pockets • Regular Cut



	DESCRIPTION	CODE NUMBER	SUGGESTED RETAIL	SIZE
A	Mossy Oak Shadow Grass Blades	30213525	48.00	S-XL
			56.00	2XL-3XL
	Mossy Oak Break-Up Country	30213528	48.00	S-XL
			56.00	2XL-3XL
	Mossy Oak Bottomland	30213519	48.00	S-XL
			56.00	2XL-3XL
	Realtree Max-5	30213576	48.00	S-XL
			56.00	2XL-3XL
B	Realtree Max-1	30213523	48.00	S-XL
			56.00	2XL-3XL
C	Realtree Xtra	30213524	48.00	S-XL
			56.00	2XL-3XL





WASATCH T-SHIRT

Lightweight, 100% cotton • Loose, comfortable fit • Crew neck
• Regular Cut

DESCRIPTION	CODE NUMBER	SUGGESTED RETAIL	SIZE
T-SHIRT, SHORT SLEEVE			
Realtree Xtra	30112524	21.00	S-XL
		23.00	2XL-3XL
T-SHIRT, LONG SLEEVE			
Realtree Xtra	30112624	23.00	S-XL
		29.00	2XL-3XL

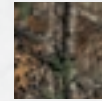

Realtree Xtra



WASATCH MESH-LITE

Cool, comfortable 100% polyester mesh fabric offers excellent ventilation **SHIRTS** Back ventilation panels • Zippered front pockets • Seven-button front • Button down collar
PANT Zippered, angled cargo pockets • Adjustable side tabs • Regular Cut



DESCRIPTION	CODE NUMBER	SUGGESTED RETAIL	SIZE
LONG SLEEVE SHIRT (SHOWN IN REALTREE XTRA)			
Mossy Oak Break-Up Country	30185028	55.00	S-XL
		63.00	2XL-3XL
Realtree Xtra	30185024	55.00	S-XL
		63.00	2XL-3XL
SHORT SLEEVE SHIRT (SHOWN IN REALTREE XTRA)			
Mossy Oak Break-Up Country	30185128	48.00	S-XL
		55.00	2XL-3XL
Realtree Xtra	30185124	48.00	S-XL
		55.00	2XL-3XL
PANT (SHOWN IN REALTREE XTRA)			
Mossy Oak Break-Up Country	30215228	63.00	S-XL
		71.00	2XL-3XL
Realtree Xtra	30215224	63.00	S-XL
		71.00	2XL-3XL

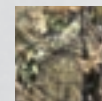

Mossy Oak Break-Up Country

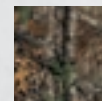

Realtree Xtra



NEW



JUNIOR WASATCH

SHIRTS 100% cotton • Loose, comfortable fit • Crew neck • Junior cut **PANT** 7 oz., 55% cotton/45% polyester twill • Deep front pockets • Oversized side cargo pockets with flap and button closure • Drawcord cuffs for snug fit around boots • Adjustable waist tabs for comfortable fit • Rear flap button-through pockets • Junior Cut



DESCRIPTION	CODE NUMBER	SUGGESTED RETAIL	SIZE
T-SHIRT, SHORT SLEEVE			
Realtree Xtra	30113624	20.00	S-XL
T-SHIRT, LONG SLEEVE			
Realtree Xtra	30113724	22.00	S-XL
PANT			
Realtree Xtra	30219024	48.00	S-XL

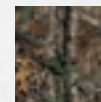

Realtree Xtra

WASATCH FOR HER

SHIRTS 100% cotton • Loose, comfortable fit • Crew neck **PANT** 7 oz., 55% cotton/45% polyester twill • Deep front pockets • Oversized side cargo pockets with flap and button closure • Drawcord cuffs for snug fit around boots • Adjustable waist tabs for comfortable fit • Rear flap button-through pockets • Women's contoured fit



DESCRIPTION	CODE NUMBER	SUGGESTED RETAIL	SIZE
T-SHIRT, SHORT SLEEVE			
Realtree Xtra	30145524	21.00	S-2XL
T-SHIRT, LONG SLEEVE			
Realtree Xtra	30145624	23.00	S-2XL
PANT			
Realtree Xtra	30216424	48.00	S-2XL

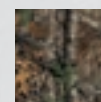

Realtree Xtra



WASATCH INSULATED HOODED JACKET

7 oz. cotton/poly twill shell fabric • Brushed tricot lining • Smooth taffeta sleeve lining for easy on/off • SelectWeight™ insulation • Large front pockets with snap closures • Drawcord hood • Rib knit cuffs • Elastic waistband • Regular Cut

DESCRIPTION	CODE NUMBER	SUGGESTED RETAIL	SIZE
(SHOWN IN REALTREE XTRA)			
Mossy Oak Break-Up Country	30413728	117.00	S-XL
		130.00	2XL-3XL
Realtree Xtra	30413724	117.00	S-XL
		130.00	2XL-3XL

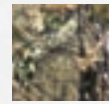

Mossy Oak Break-Up Country

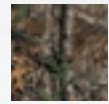

Realtree Xtra

NEW



WASATCH BUCKMARK HOODIE

Midweight cotton/polyester blend • Rib knit cuffs and waist seal in warmth • Drawcord hood • Kangaroo-style handwarmer pocket • Regular Cut

DESCRIPTION	CODE NUMBER	SUGGESTED RETAIL	SIZE
(SHOWN IN REALTREE XTRA)			
Mossy Oak Break-Up Country	30113028	64.00	S-XL
		70.00	2XL-3XL
Realtree Xtra	30113024	64.00	S-XL
		70.00	2XL-3XL

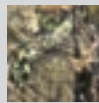

Mossy Oak Break-Up Country

NEW

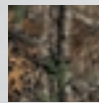

Realtree Xtra



NEW

NEW

WASATCH PERFORMANCE II HOODIE

100% polyester fleece • Outer fabric surface is smooth, inner fabric is fleece for additional warmth • Rib knit cuffs seal in warmth • Drawcord hood • Kangaroo-style handwarmer pocket • Appliqué patch logo • Regular Cut

DESCRIPTION	CODE NUMBER	SUGGESTED RETAIL	SIZE
HOODIE (SHOWN IN REALTREE XTRA)			
Mossy Oak Break-Up Country	30173828	80.00	S-XL
		92.00	2XL-3XL
Realtree Xtra	30173824	80.00	S-XL
		92.00	2XL-3XL
HOODIE FOR HER (SHOWN IN REALTREE XTRA)			
Mossy Oak Break-Up Country	30174028	80.00	S-2XL
Realtree Xtra	30174024	80.00	S-2XL

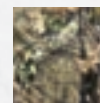

Mossy Oak Break-Up Country

NEW

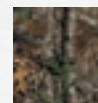

Realtree Xtra



WASATCH TWO-TONE II HOODIE

100% polyester fleece • Outer fabric surface is smooth, inner fabric is fleece for additional warmth • Contrasting solid color panels • Rib knit cuffs seal in warmth • Drawcord hood • Kangaroo-style handwarmer pocket • Appliqué patch logo • Regular Cut

DESCRIPTION	CODE NUMBER	SUGGESTED RETAIL	SIZE
(SHOWN IN REALTREE XTRA)			
Mossy Oak Break-Up Country	30173928	80.00	S-XL
		92.00	2XL-3XL
Realtree Xtra	30173924	80.00	S-XL
		92.00	2XL-3XL

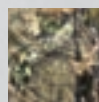

Mossy Oak Break-Up Country

NEW

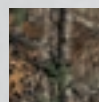

Realtree Xtra



NEW

DIRTY BIRD — PERFECT FOR DIRTY BUSINESS.

If a marsh is the office, and bibs and a parka a business suit, dress for success in Browning Dirty Bird. Dirty Bird waterfowl gear is built to keep hunters comfortably in the field regardless of the conditions. Browning professionals have spent countless hours testing these products and the evidence shows with features only real-world experience can develop. Waterfowling is a dirty business, and business is good with Dirty Bird.

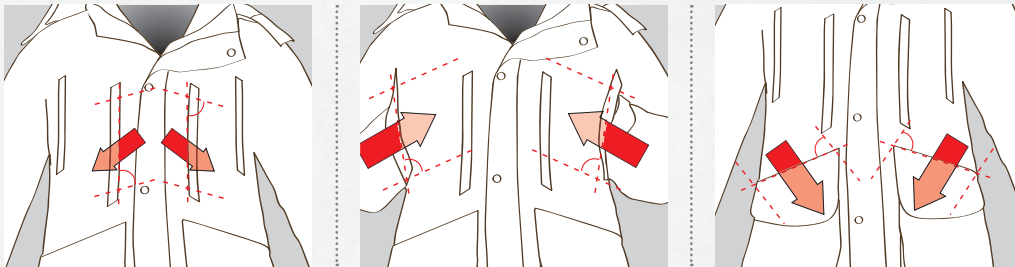
**ANGLE-ENTRY POCKETS**

- Angle-Entry pockets are designed around the arm and hand.
- When the hands are above the elbows they naturally point up, and when they are below the elbows they point down.
- The interiors of the chest accessory Angle-Entry pockets and the shell pockets are slanted down to align with hand angles while the two handwarmer Angle-Entry pockets slant up.

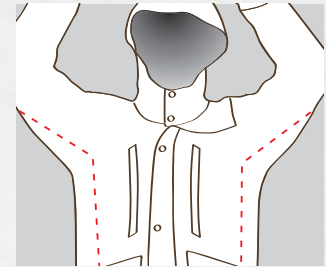
**ARROW GUSSETS**

- The Arrow Gusset armpit design has a smooth, tapering shape as it rises along the side to under the sleeve.
- Offers a better fit, enhanced range of movement and no binding.

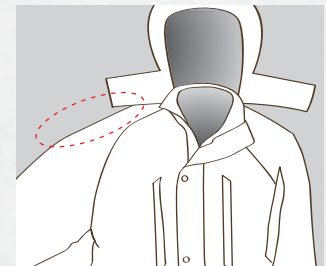
**RAGLAN SLEEVES**

- Raglan sleeves are cut at a long tapering angle right up to the collar line.
- The top of the sleeve becomes one seamless piece of fabric all along the shoulder with no exposed seams to leak, even in the worst downpours.



Fred Zink, Host of Avian-X



DIRTY BIRD 4-IN-1 PARKA

SHELL Pre-Vent waterproof, breathable fabric shell • Angle-Entry pocket design • Two upper Angle-Entry handwarmer pockets • Two zippered chest Angle-Entry accessory pockets • Two lower bellows Angle-Entry pockets with magnetic closure and internal pleat • Raglan sleeve design eliminates top shoulder seam for a more waterproof design • Arrow Gusset armpit design and articulated elbow for greater range of motion • Overlay forearm patches to prevent wear • Detachable, adjustable hood • Inside security pocket • External and internal storm flap • Adjustable, watertight laminated cuffs • Molded shoulder strips prevent wear on shoulder areas • Internal waist drawcord • Mesh moisture barrier strip between shell and lining • X-Change System compatible • License tab **LINER** Camo fleece reverses to solid-color woven fabric • PrimaLoft® Synergy insulation • Set-in sleeves • Elasticized bottom and cuffs • Two slash pockets on each side • X-Change System compatible • Regular Cut

DESCRIPTION	CODE NUMBER	SUGGESTED RETAIL	SIZE
(SHOWN IN MOSSY OAK SHADOW GRASS BLADES)			
Mossy Oak Shadow Grass Blades	30330025	440.00	S-XL
		450.00	2XL-3XL
Realtree Max-5	30330076	440.00	S-XL
		450.00	2XL-3XL

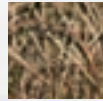

Mossy Oak Shadow Grass Blades

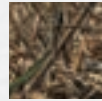

Realtree Max-5



DIRTY BIRD WADER JACKET

Pre-Vent waterproof, breathable fabric shell • PrimaLoft® Synergy insulation maximizes warmth and freedom of movement • Angle-Entry pocket design • Two upper Angle-Entry handwarmer pockets • Two lower bellows Angle-Entry shell pockets with magnetic closure and internal pleat • Raglan sleeve eliminates top shoulder seam for a more waterproof design • Arrow Gusset armpit design and articulated elbow for greater range of motion • Overlay forearm patches to prevent wear • Detachable, adjustable hood • Inside security pocket • Watertight zipper guard • Adjustable, watertight laminated cuffs • Molded shoulder strips prevent wear on shoulder areas • Mesh moisture barrier strip between shell and lining • Shorter wader design with elasticized waist • License tab • Regular Cut

DESCRIPTION	CODE NUMBER	SUGGESTED RETAIL	SIZE
(SHOWN IN MOSSY OAK SHADOW GRASS BLADES)			
Mossy Oak Shadow Grass Blades	30430125	335.00	S-XL
		345.00	2XL-3XL
Realtree Max-5	30430176	335.00	S-XL
		345.00	2XL-3XL

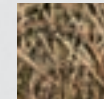

Mossy Oak Shadow Grass Blades

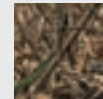

Realtree Max-5



DIRTY BIRD INSULATED BIBS

Pre-Vent waterproof, breathable fabric shell • PrimaLoft® Synergy insulation • Overlay protection on seat, knees and inner cuff • Articulated knees for greater range of motion • Full-length, two-way side and front zippers with storm flaps • Rib knit side gussets • Elasticized shoulder straps with cam lock buckles • Two front handwarmer pockets • One zippered chest pocket • Mesh moisture barrier strip between shell and lining • Regular Cut

DESCRIPTION	CODE NUMBER	SUGGESTED RETAIL	SIZE
(SHOWN IN REALTREE MAX-5)			
Mossy Oak Shadow Grass Blades	30630125	295.00	S-XL
		305.00	2XL-3XL
Realtree Max-5	30630176	295.00	S-XL
		305.00	2XL-3XL

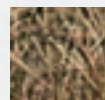

Mossy Oak Shadow Grass Blades

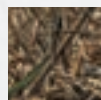

Realtree Max-5





DIRTY BIRD TIMBER — OPTIMIZED FOR FLOODED COUNTRY.

Dirty Bird Timber is optimized for hunting in this unique environment with shorter length jacket styles that keep them above the waterline and keep your gear dry. Soft shells include UTW (Under The Wader) Technology with water-resistant uppers and breathable fleece lowers that, you guessed it, fit easily underneath chest waders. Our fleeces are also designed to wear inside waders and have the advantage of splash protection panels on the sleeves.



DIRTY BIRD TIMBER WADER JACKET

Pre-Vent waterproof, breathable fabric shell • Shorter wader length with elastic drawcord waist • Angle-Entry pocket design • Two upper Angle-Entry handwarmer pockets • Two lower bellows shell Angle-Entry pockets with magnetic closure and internal pleat • Raglan sleeve design eliminates top shoulder seam for a more waterproof design • Arrow Gusset armpit design and articulated elbow for greater range of motion • Overlay forearm patches to prevent wear • Detachable, adjustable hood • Inside security pocket • External and internal storm flap • Adjustable, watertight laminated cuffs • Molded shoulder strips prevent wear on shoulder areas • Mesh moisture barrier strip between shell and lining • License tab • Regular Cut

DESCRIPTION	CODE NUMBER	SUGGESTED RETAIL	SIZE
(SHOWN IN REALTREE MAX-5)			
Mossy Oak Bottomland	30432019	306.00	S-XL
		319.00	2XL-3XL
Realtree Max-5	30432076	306.00	S-XL
		319.00	2XL-3XL

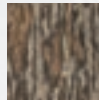

Mossy Oak Bottomland

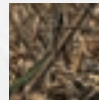

Realtree Max-5



DIRTY BIRD TIMBER RAIN JACKET

Lightweight Pre-Vent shell fabric is 100% waterproof/windproof/breathable • Taped seams prevent water entry • Articulated patterning provides comfort and additional freedom of movement • Attached hood is fully adjustable for complete protection from the elements • Elasticized, hook and loop adjustable cuffs seal out water and wind • Welded chest pocket with laminated zipper closure • Two large handwarmer pockets with laminated zipper closures • All pocket zippers have garages to prevent water entry • Internal storm flap with fleece lined beard guard • Drop-back bottom hem with drawcord seals in warm air and prevents drafts • Corded zipper pulls reduce noise and are easy to grab even with gloves on • License tab • Regular Cut

DESCRIPTION	CODE NUMBER	SUGGESTED RETAIL	SIZE
(SHOWN IN MOSSY OAK BOTTOMLAND)			
Mossy Oak Bottomland	30432119	306.00	S-XL
		319.00	2XL-3XL
Realtree Max-5	30432176	306.00	S-XL
		319.00	2XL-3XL

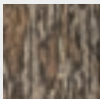

Mossy Oak Bottomland



Realtree Max-5





DIRTY BIRD TIMBER SOFT SHELL 1/4 ZIP TOP AND HOODIE

UTW Technology provides water-resistant protection on top and breathable fabric on bottom for extra comfort underneath chest waders • 2-Layer wind- and water-resistant fabric on the chest and sleeves provides water and splash protection • Highly breathable smoothbore fleece fabric on the lower half of the body • Lined sleeves for easy on/off • Angle-Entry pocket design • Two upper handwarmer pockets • One zippered chest pocket • One magnetic chest pocket • Lower zippered pockets • Drawcord bottom • 1/4-length zipper • Lycra® binding cuff • Stand-up, zip-through collar • Athletic Cut

DESCRIPTION	CODE NUMBER	SUGGESTED RETAIL	SIZE
1/4 ZIP (SHOWN IN MOSSY OAK BOTTOMLAND)			
Mossy Oak Bottomland	30162019	199.00	S-XL
		213.00	2XL-3XL
Realtree Max-5	30162076	199.00	S-XL
		213.00	2XL-3XL
HOODIE (SHOWN IN REALTREE MAX-5)			
Mossy Oak Bottomland	30162119	199.00	S-XL
		213.00	2XL-3XL
Realtree Max-5	30162176	199.00	S-XL
		213.00	2XL-3XL



NEW



NEW

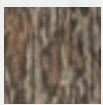

Mossy Oak Bottomland

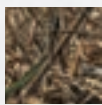

Realtree Max-5



ATHLETIC CUT



MOSSY OAK



REALTREE



NEW



NEW

DIRTY BIRD TIMBER FLEECE 1/4 ZIP TOP AND HOODIE

Stretchable midweight fleece fabric with Smoothbore outer facing • 2-Layer wind- and water-resistant fabric on the sleeves provides splash protection • Angle-Entry pocket design • Two upper handwarmer pockets • Hoodie has lower kangaroo pocket • Thumbhole cuff design • Welded shoulder pocket with zipper • Lycra® binding waist • Athletic Cut

DESCRIPTION	CODE NUMBER	SUGGESTED RETAIL	SIZE
1/4 ZIP (SHOWN IN REALTREE MAX-5)			
Mossy Oak Bottomland	30162219	186.00	S-XL
		199.00	2XL-3XL
Realtree Max-5	30162276	186.00	S-XL
		199.00	2XL-3XL
HOODIE (SHOWN IN MOSSY OAK BOTTOMLAND)			
Mossy Oak Bottomland	30162319	186.00	S-XL
		199.00	2XL-3XL
Realtree Max-5	30162376	186.00	S-XL
		199.00	2XL-3XL

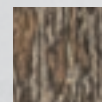

Mossy Oak Bottomland

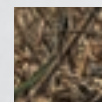

Realtree Max-5



ATHLETIC CUT



MOSSY OAK



REALTREE



DIRTY BIRD WINDKILL JACKET

3-Layer WindKill fabric blocks wind and prevents water from soaking through • Low-nap fleece inner liner • Lined sleeves for easy on/off • Angle-Entry pocket design • Two upper handwarmer pockets • One zippered pocket • One magnetic chest pocket • Lower zippered pockets • Gusseted shoulder panels for greater range of motion • Mesh lined zip pits • Adjustable, watertight laminated cuffs • Drawcord bottom • Full-length zipper • Stand-up, zip-through collar • Athletic Cut

DESCRIPTION	CODE NUMBER	SUGGESTED RETAIL	SIZE
(SHOWN IN REALTREE MAX-5)			
Mossy Oak Shadow Grass Blades	30430625	250.00	S-XL
		260.00	2XL-3XL
Realtree Max-5	30430676	250.00	S-XL
		260.00	2XL-3XL

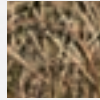

Mossy Oak Shadow Grass Blades

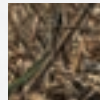

Realtree Max-5



DIRTY BIRD SOFT SHELL PULLOVER

2-Layer wind- and water-resistant fabric • Highly breathable • Low-nap fleece inner liner with lined sleeves for easy on/off • Angle-Entry pocket design • Two upper handwarmer pockets • One zippered chest pocket • One magnetic chest pocket • Lower zippered pockets • Drawcord bottom • 1/4-length zipper • Lycra® binding cuff • Stand-up, zip-through collar • Athletic Cut

DESCRIPTION	CODE NUMBER	SUGGESTED RETAIL	SIZE
(SHOWN IN MOSSY OAK SHADOW GRASS BLADES)			
Mossy Oak Shadow Grass Blades	30430525	199.00	S-XL
		213.00	2XL-3XL
Realtree Max-5	30430576	199.00	S-XL
		213.00	2XL-3XL

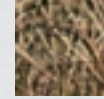

Mossy Oak Shadow Grass Blades

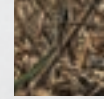

Realtree Max-5



DIRTY BIRD WADER PANT

2-Layer wind- and water-resistant fabric • Single layer fabric below the knee to eliminate bulk in the wader • Hook and loop adjustable tabs on the cuffs tighten around the ankle for sliding into waders • Smooth shell fabric allows waders to slide on/off easy and adds range of motion while wearing with waders • Fully constructed waist with partial elastic waistband • One rear security pocket and two front pockets • Athletic Cut

DESCRIPTION	CODE NUMBER	SUGGESTED RETAIL	SIZE
(SHOWN IN MOSSY OAK SHADOW GRASS BLADES)			
Mossy Oak Shadow Grass Blades	30230525	130.00	S-XL
		145.00	2XL-3XL
Realtree Max-5	30230576	130.00	S-XL
		145.00	2XL-3XL

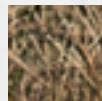

Mossy Oak Shadow Grass Blades

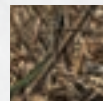

Realtree Max-5





DIRTY BIRD SMOOTHBORE FLEECE 1/4 ZIP TOP

Stretchable midweight fleece fabric with Smoothbore outer facing • Angle-Entry pocket design • Two upper handwarmer pockets • Thumbhole cuff design • 1/4 zip front with stand-up, zip-through collar • Full-length zipper guard and chin protector • Welded shoulder pocket with zipper • Lycra® binding waist and collar • Athletic Cut

DESCRIPTION	CODE NUMBER	SUGGESTED RETAIL	SIZE
(SHOWN IN REALTREE MAX-5)			
Mossy Oak Shadow Grass Blades	30160525	173.00	S-XL
		190.00	2XL-3XL
Realtree Max-5	30160576	173.00	S-XL
		190.00	2XL-3XL

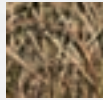

Mossy Oak Shadow Grass Blades

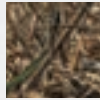

Realtree Max-5



DIRTY BIRD SMOOTHBORE FLEECE HOODIE

Stretchable midweight fleece fabric with Smoothbore outer facing • Angle-Entry pocket design • Two upper handwarmer pockets • Lower kangaroo pockets • Thumbhole cuff design • Attached hood with drawcord • Welded shoulder pocket with zipper • Lycra® binding waist • Athletic Cut

DESCRIPTION	CODE NUMBER	SUGGESTED RETAIL	SIZE
(SHOWN IN MOSSY OAK SHADOW GRASS BLADES)			
Mossy Oak Shadow Grass Blades	30160625	190.00	S-XL
		205.00	2XL-3XL
Realtree Max-5	30160676	190.00	S-XL
		205.00	2XL-3XL

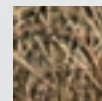

Mossy Oak Shadow Grass Blades

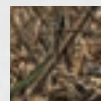

Realtree Max-5



NEW

DIRTY BIRD HOODIE

Midweight cotton/polyester blend fabric • Rib knit cuffs and waist seal in warmth • Drawcord hood • Kangaroo-style handwarmer pocket • Regular Cut

DESCRIPTION	CODE NUMBER	SUGGESTED RETAIL	SIZE
Realtree Max-5	30160776	64.00	S-XL
		70.00	2XL-3XL

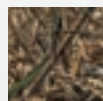

Realtree Max-5



DIRTY BIRD BEANIE

Stretchable midweight fleece fabric with Smoothbore outer facing resists wind • Low-nap fleece lining

DESCRIPTION	CODE NUMBER	SUGGESTED RETAIL	SIZE
(SHOWN IN REALTREE MAX-5)			
Mossy Oak Shadow Grass Blades	30836325	44.00	One Size
Realtree Max-5	30836376	44.00	One Size

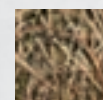

Mossy Oak Shadow Grass Blades

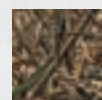

Realtree Max-5





DIRTY BIRD INSULATED DECOY GLOVE

Revolutionary OutDry® membrane lamination process for 100% waterproof protection • PrimaLoft® One insulation • Decoy length gauntlet with a unique one-handed cord lock closure • Elasticized wrist for snug fit • Overlay on palm, thumb and fingers for firm grip • Articulated fingers with Sensi-Flex trigger finger

DESCRIPTION	CODE NUMBER	SUGGESTED RETAIL	SIZE
(SHOWN IN MOSSY OAK SHADOW GRASS BLADES)			
Mossy Oak Shadow Grass Blades	30796025	130.00	M-XL
Realtree Max-4	30796022	130.00	M-XL

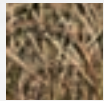

Mossy Oak Shadow Grass Blades

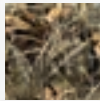

Realtree Max-4



DIRTY BIRD GUNNER'S GLOVE

Revolutionary OutDry® membrane lamination process for 100% waterproof protection • Elasticized wrist for snug fit • Overlay on palm, thumb and fingers for firm grip • Articulated fingers with Sensi-Flex trigger finger

DESCRIPTION	CODE NUMBER	SUGGESTED RETAIL	SIZE
(SHOWN IN MOSSY OAK SHADOW GRASS BLADES)			
Mossy Oak Shadow Grass Blades	30796125	117.00	M-XL
Realtree Max-4	30796122	117.00	M-XL

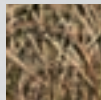

Mossy Oak Shadow Grass Blades

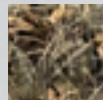

Realtree Max-4



DIRTY BIRD INSULATED GLOVE

Revolutionary OutDry® membrane lamination process for 100% waterproof protection • PrimaLoft® One insulation • Elasticized wrist for snug fit • Overlay on palm, thumb and fingers for firm grip

DESCRIPTION	CODE NUMBER	SUGGESTED RETAIL	SIZE
(SHOWN IN MOSSY OAK SHADOW GRASS BLADES)			
Mossy Oak Shadow Grass Blades	30796225	117.00	M-XL
Realtree Max-4	30796222	117.00	M-XL

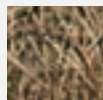

Mossy Oak Shadow Grass Blades

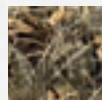

Realtree Max-4



DIRTY BIRD INSULATED HANDWARMER

3mm neoprene construction • Fleece lined handwarmer compartment with internal handwarmer pockets • 20 shell loops • Dual bellows pockets each hold a box of shells • Zippered valuables pouch • Adjustable nylon belt with buckle fits up to a 60" waist size

DESCRIPTION	CODE NUMBER	SUGGESTED RETAIL	SIZE
Realtree Max-5	12922	65.00	One Size

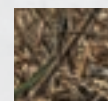

Realtree Max-5





Fred Zink, Host of *Avian-X*

FULL CURL WOOL.

Chasing a once-in-a-lifetime ram across scree-covered slopes will quickly show the weaknesses in any product. Leave nothing to chance with rugged and versatile FCW Mountain. These wool designs feature a tailored Athletic Cut that trims bulk and excess weight for easier movement.

FCW MOUNTAIN JACKET

3-Layer bonded wool construction • WindKill laminate blocks wind and provides water resistance in all but the most extreme weather • Soft fleece lining • Washable • Two zippered upper chest pockets • Zippered shoulder pocket • Slash handwarmer pockets • Stand-up collar • Internal cuffs • Browning AllTerrain Brown camouflage pattern • Athletic Cut

DESCRIPTION	CODE NUMBER	SUGGESTED RETAIL	SIZE
AllTerrain Brown	30409012	226.00	S-XL
		239.00	2XL-3XL

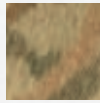

AllTerrain Brown



PRICE REDUCTION



PRICE REDUCTION



FCW MOUNTAIN VEST

3-Layer bonded wool construction • WindKill laminate blocks wind and provides water resistance in all but the most extreme weather • Soft fleece lining • Washable • Two zippered upper chest pockets • Slash handwarmer pockets • Stand-up collar • Browning AllTerrain Brown camouflage pattern • Athletic Cut

DESCRIPTION	CODE NUMBER	SUGGESTED RETAIL	SIZE
AllTerrain Brown	30509012	133.00	S-XL
		159.00	2XL-3XL

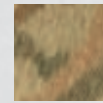

AllTerrain Brown



PRICE REDUCTION

FCW MOUNTAIN PANT

3-Layer bonded wool construction • WindKill laminate blocks wind and provides water resistance in all but the most extreme weather • Soft fleece lining • Washable • Slash front pockets • Two thigh pockets • Rear bellows pockets • Fully constructed waist • Articulated knees • Browning AllTerrain Brown camouflage pattern • Athletic Cut

DESCRIPTION	CODE NUMBER	SUGGESTED RETAIL	SIZE
AllTerrain Brown	30209012	226.00	S-XL
		239.00	2XL-3XL

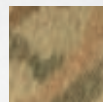

AllTerrain Brown



NEW

KNITTED WOOL 1/4 ZIP SWEATER

Soft, warm, comfortable, breathable Merino wool/acrylic blend
 • Shoulder overlays • Rib knit cuffs and hem • Handwarmer pocket
 • Regular Cut

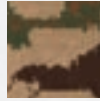

AllTerrain Brown



DESCRIPTION	CODE NUMBER	SUGGESTED RETAIL	SIZE
AllTerrain Brown	30109019	186.00	S-XL
		199.00	2XL-3XL



FULL CURL WOOL BASE LAYER SHIRTS

Comfortable, no-itch Merino wool blend construction • Breathable polyester side panels
 • Odor reduction from natural antimicrobial properties of wool • Self fabric neck and cuffs • Mock neck or 1/4 zip styles • Athletic Cut

DESCRIPTION	CODE NUMBER	SUGGESTED RETAIL	SIZE
MOCK NECK			
Loden	30119929	88.00	S-XL
		94.00	2XL-3XL
1/4 ZIP			
Loden	30119129	93.00	S-XL
		99.00	2XL-3XL



Loden



FULL CURL WOOL BASE LAYER PANT

Comfortable, no-itch Merino wool blend construction • Odor reduction from natural antimicrobial properties of wool • Self fabric cuffs
 • Elastic waistband • Fly opening • Athletic Cut



Loden



DESCRIPTION	CODE NUMBER	SUGGESTED RETAIL	SIZE
Loden	30219929	88.00	S-XL
		94.00	2XL-3XL



PHEASANTS FOREVER® — JOIN THE CAUSE.

Without the conservation efforts of Pheasants Forever, millions of acres of prime pheasant habitat would be lost. Pheasants Forever chapters all over the United States work to protect, restore and enhance wildlife habitat by establishing and maintaining local and regional projects. From encouraging farmers to leave longer wheat stubble, to the purchase of upland habitat land, Pheasants Forever continues to work to preserve America's favorite game bird. To become a member or volunteer, please call toll free (877) 773-2070. With every Browning Pheasants Forever product sold, we proudly make a contribution to this most worthy conservation organization.

PHEASANTS FOREVER JACKET

12 oz., 100% cotton canvas • 100% polyester blaze overlay — over 400 square inches • Available with Pheasants Forever embroidery • Large bloodproof front load game bag with zip opening for easy cleaning • Shell pockets • Hook and loop pocket flap for easy shell pocket access • D-rings for dog training accessories • Two zippered front pockets • Two-way front zipper with snap storm flap • Adjustable cuffs • REACTAR G2 pad pocket behind each shoulder patch (pad sold separately) • Regular Cut

DESCRIPTION	CODE NUMBER	SUGGESTED RETAIL	SIZE
With Pheasants Forever Embroidery	30411632	159.00	S-XL
		173.00	2XL-3XL
Without Pheasants Forever Embroidery	30411932	159.00	S-XL
		173.00	2XL-3XL



PHEASANTS FOREVER VEST

12 oz., 100% cotton canvas • Bloodproof game bag with zip opening • Available with or without Pheasants Forever embroidery • Two zippered front pockets • Zipper front • D-rings for dog training accessories • REACTAR G2 pad pocket behind each shoulder patch (pad sold separately) • Regular Cut

DESCRIPTION	CODE NUMBER	SUGGESTED RETAIL	SIZE
With Pheasants Forever Embroidery	30511632	117.00	S-XL
		130.00	2XL-3XL
Without Pheasants Forever Embroidery	30511932	117.00	S-XL
		130.00	2XL-3XL



PHEASANTS FOREVER STRAP VEST

Mesh-back game bag with a breathable, bloodproof laminate in the game bag • Shell pockets • Adjustable shoulder straps • Adjustable front belt with speed buckle • Side adjustment straps • Available with or without Pheasants Forever embroidery • Regular Cut

DESCRIPTION	CODE NUMBER	SUGGESTED RETAIL	SIZE
With Pheasants Forever Embroidery	30511732	88.00	One Size
Without Pheasants Forever Embroidery	30512032	88.00	One Size





KEEP MOVING.

Most of the really grabby bushes and briars are below the waist. Upland pants and chaps prevent the barbs from reaching the skin and the smooth surface allows hunters to slip through heavy cover.



PHEASANTS FOREVER PANT

12 oz., 100% cotton canvas • Briar-resistant overlay • Comfortable, work pant style fit • Deep front pockets
 • Zipper fly • Flap rear pockets • Available with or without Pheasants Forever embroidery • Regular Cut
 • Waist 32"-44" • Inseam lengths 30", 32"

DESCRIPTION	CODE NUMBER	SUGGESTED RETAIL	SIZE
With Pheasants Forever Embroidery	30211632	88.00	32-38
		102.00	40-44
Without Pheasants Forever Embroidery	30211932	88.00	32-38
		102.00	40-44



PHEASANTS FOREVER CHAPS

12 oz., 100% cotton canvas • Briar-resistant overlay • Double sized adjustment loops with hook and loop closures • Snap side opening for easy on and off • Available with or without Pheasants Forever embroidery • Regular Cut • Inseam lengths 28" Regular, 31" Tall

DESCRIPTION	CODE NUMBER	SUGGESTED RETAIL	SIZE
With Pheasants Forever Embroidery	30011632	79.00	Reg, 28
		86.00	Tall, 31
Without Pheasants Forever Embroidery	30011932	79.00	Reg, 28
		86.00	Tall, 31



BIRD'N LITE JACKET

Browning Bird'n Lite Technology weight distribution system secures the load • Rugged, lightweight cotton/polyester shell fabric • Blaze shoulder overlays • Front-loading bloodproof game bag with zip-top opening and load stabilizing strap • Oversized shell pockets with internal shell loops and snap closures • Built-in rucksack with elastic top and buckle strap closure • Zipper front • Transmitter pocket with antenna loop • REACTAR G2 pad pockets behind each quilted shoulder patch (pad sold separately) • Lined handwarmer pockets behind shell pockets • Water bottle pockets • D-rings for accessories • Hook and loop adjustable elastic cuffs • Available with or without Pheasants Forever embroidery • Zip-through collar • License tab • Regular Cut

DESCRIPTION	CODE NUMBER	SUGGESTED RETAIL	SIZE
With Pheasants Forever Embroidery	30468958	220.00	S-XL
		233.00	2XL-3XL
Without Pheasants Forever Embroidery	30468858	220.00	S-XL
		233.00	2XL-3XL



Sternum strap keeps shoulder straps in place.

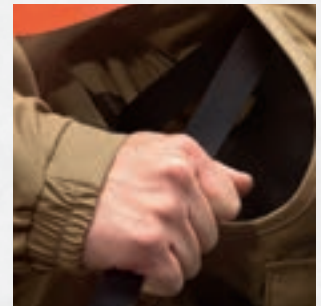

Load bearing straps are adjusted within game bag pockets.



Weight is evenly distributed between the shoulders and hips.



Adjustable waist belt secures the load to the hips.

- Wide nylon shoulder straps transfer the load to the shoulders, yet still allow hunters to swing through the bird naturally.
- Quick-release sternum strap helps keep the weight centered between the shoulders for improved balance and less fatigue.
- Fully-adjustable load bearing straps place the load's center of gravity where it's most comfortable to carry.
- Ergonomically-contoured, padded adjustable waist belt offers added support to the lower back and allows part of the load to be carried on the hips for greater comfort.
- Quick-release composite buckle allows for quick on and off.



LITE'N UP.

Carrying pheasants, water, lunch and shells can get heavy in a traditional upland hunting vest. Ease the burden and hunt harder and longer with Browning Bird'n Lite gear. Essentially a backpack disguised as an upland hunting rig, the integrated load bearing system evenly distributes weight between the shoulders and hips, and secures it from flapping and swaying, to reduce fatigue and increase comfort all day long.

BIRD'N LITE VEST

Browning Bird'n Lite Technology weight distribution system secures the load • Rugged, lightweight cotton/polyester shell fabric • Blaze shoulder overlays • Front-loading bloodproof game bag with zip-top opening and load stabilizing strap • Oversized shell pockets with internal shell loops and snap closures • Built-in rucksack with elastic top • Zipper front • Transmitter pocket with antenna loop • REACTAR G2 pad pockets behind each quilted shoulder patch (pad sold separately) • Lined handwarmer pockets behind shell pockets • Water bottle pockets • D-rings for accessories • Available with or without Pheasants Forever embroidery • License tab • Regular Cut

DESCRIPTION	CODE NUMBER	SUGGESTED RETAIL	SIZE
With Pheasants Forever Embroidery	30568958	175.00	S-XL
		190.00	2XL-3XL
Without Pheasants Forever Embroidery	30568858	175.00	S-XL
		190.00	2XL-3XL



BIRD'N LITE STRAP VEST

Browning Bird'n Lite Technology weight distribution system secures the load • Rugged, lightweight cotton/polyester shell fabric • Padded blaze shoulder straps • Front-loading bloodproof game bag with load stabilizing strap • Oversized shell pockets with internal shell loops and snap closures • Built-in rucksack with elastic top • Adjustable belt • Lined handwarmer pockets behind shell pockets • Water bottle pockets • Available with or without Pheasants Forever embroidery • Regular Cut

DESCRIPTION	CODE NUMBER	SUGGESTED RETAIL	SIZE
With Pheasants Forever Embroidery	30068958	175.00	M/L
		175.00	XL/2XL
Without Pheasants Forever Embroidery	30068858	175.00	M/L
		175.00	XL/2XL





CROSS COUNTRY WINDKILL JACKET

3-Layer, 4-way stretch fabric features a hard-faced, abrasion-resistant nylon shell • Windproof and water-repellent WindKill laminate middle layer • Soft fleece lining • Highly breathable • Underarm ventilation zippers regulate heat • Two slash pockets, two chest pockets • Drawcord waist • Full-length zipper • Stand-up collar • Regular Cut

DESCRIPTION	CODE NUMBER	SUGGESTED RETAIL	SIZE
Khaki/Loden	30413040	186.00	S-XL
		199.00	2XL-3XL



Khaki Loden



CROSS COUNTRY UPLAND SHIRT

100% polyester fabric moves moisture away from the body • Blaze or loden overlays and shoulder patch • REACTAR G2 pad pocket (pad sold separately) • Angled front pocket • Regular Cut

DESCRIPTION	CODE NUMBER	SUGGESTED RETAIL	SIZE
(SHOWN IN KHAKI/LODEN)			
Khaki/Loden	30119340	69.00	S-XL
		75.00	2XL-3XL
Khaki/Blaze	30119358	69.00	S-XL
		75.00	2XL-3XL



Khaki Loden Khaki Blaze



PRAIRIELANDS UPLAND SHIRT

100% cotton canvas • Contrasting sleeve and shoulder • Pleated action back for comfort and mobility • Chest pocket • REACTAR G2 pad pocket (pad sold separately) • Padded shoulder patch • Longer sleeve placket for easy roll-up • Button-down collar • Regular Cut

DESCRIPTION	CODE NUMBER	SUGGESTED RETAIL	SIZE
Desert/Forest	30113764	73.00	S-XL
		80.00	2XL-3XL



Desert Forest



NTS UPLAND SHIRT

Moisture moving 100% polyester fabric is perfect for hot weather bird hunting • Two-tone design • Athletic Cut

DESCRIPTION	CODE NUMBER	SUGGESTED RETAIL	SIZE
Khaki/Blaze	30118201	53.00	S-XL
		60.00	2XL-3XL



Khaki Blaze



CHILL OUT.

Warm weather hunting is made easier with the right gear. We build products that make excellent use of breathable mesh and lightweight fabrics to help keep hunters cool.

NEW

UPLAND GAME VEST

100% poly oxford • Front load bloodproof game bag • Elasticized shell loops • Large bellows pockets • Mesh sides and back for light weight and increased ventilation • Regular Cut

DESCRIPTION	CODE NUMBER	SUGGESTED RETAIL	SIZE
Realtree Xtra	30517024	73.00	S-XL
		80.00	2XL-3XL

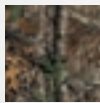

Realtree Xtra



NEW

UPLAND DOVE VEST

7 oz. 55%/45% cotton/poly twill fabric • Lightweight, comfortable design is ideal for hot weather • Mesh front and back panels provide greater breathability • Two bellows shell pockets • Bloodproof rear game bag • Zippered front • Regular Cut

DESCRIPTION	CODE NUMBER	SUGGESTED RETAIL	SIZE
Realtree Xtra	30510324	48.00	S-XL
		56.00	2XL-3XL

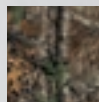

Realtree Xtra



BELTED DOVE GAME BAG

100% poly oxford fabric • Web belt with adjustable buckle • Two large shell pockets with accessory pockets for choke tubes, glasses and other small items • Large bloodproof game bag with mesh sides for ventilation • Pockets slide on belt for easy positioning • Snap closures • Regular Cut

DESCRIPTION	CODE NUMBER	SUGGESTED RETAIL	SIZE
Realtree Xtra	30910624	48.00	One Size

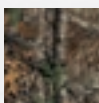

Realtree Xtra



NEW



SAFETY FIRST.

Often overlooked until the last minute of hunt preparation, the safety orange vest is often a necessary hunting requirement. Don't skimp on a cheap vest, buy a long-lasting, functional vest with large pockets for gear and ammo.

SAFETY VEST

100% polyester oxford • Zip front • Back license loop • Large snap flap shell pockets • Buckmark embroidery on front and back • Regular Cut

DESCRIPTION	CODE NUMBER	SUGGESTED RETAIL	SIZE
Blaze	30510001	26.00	S-3XL



Blaze



JUNIOR SAFETY VEST

100% polyester oxford • Zip front • Back license loop • Large snap flap shell pockets • Buckmark embroidery on front and back • Junior cut
SIZES S (6-8), M (10-12), L (14-16), XL (18-20)

DESCRIPTION	CODE NUMBER	SUGGESTED RETAIL	SIZE
Blaze	30550001	23.00	S-XL



Blaze



JUNIOR UPLAND SAFETY VEST

100% polyester oxford • Zip front • Rear game bag • Back license loop
 • Large snap flap shell pockets • Buckmark embroidery on front and back
 • Junior cut **SIZES** S (6-8), M (10-12), L (14-16), XL (18-20)

DESCRIPTION	CODE NUMBER	SUGGESTED RETAIL	SIZE
Blaze	30528001	33.00	S-XL



Blaze







TEAM BROWNING SHOOTING VEST

Full-length suede shooting patch • 100% cotton body construction • Mesh sides for ventilation • Two-way front zipper • Four large front shell pockets • Bar tacks at all stress points • Side tab adjustments • Sewn-in REACTAR G2 pad pocket (pad sold separately) • Split shoulder for ease of movement • Chest pocket • D-rings for towel

DESCRIPTION	RIGHT/LEFT	CODE NUMBER	SUGGESTED RETAIL	SIZE
Black/Gold	Right-Hand	30515499	85.00	S-3XL

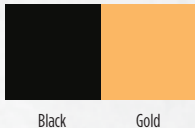

TEAM BROWNING POLO SHIRTS

Cool, breathable 100% polyester construction is lightweight to keep shooters cool • Sublimated graphics printing won't crack or fade

DESCRIPTION	CODE NUMBER	SUGGESTED RETAIL	SIZE
Gold/Black	30105273	88.00	S-XL
		94.00	2XL-3XL
RTX/Black	30105224	88.00	S-XL
		94.00	2XL-3XL

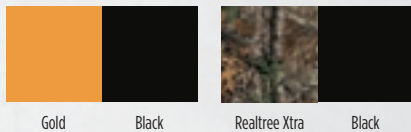

TEAM BROWNING T-SHIRTS

Cool, breathable 100% polyester construction is lightweight to keep shooters cool • Sublimated graphics printing won't crack or fade

DESCRIPTION	CODE NUMBER	SUGGESTED RETAIL	SIZE
Short Sleeve	30105473	88.00	S-XL
		94.00	2XL-3XL
Long Sleeve	30105373	100.00	S-XL
		107.00	2XL-3XL

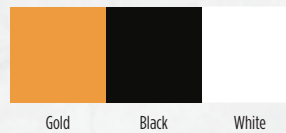

TEAM BROWNING GLOVE **NEW**

Durable 4-way stretch hard face fleece shell fabric provides lightweight warmth • Flat seamed palm and back of hand for added comfort and durability • Silicone imprint on palm and fingertips improves grip • Washable

DESCRIPTION	CODE NUMBER	SUGGESTED RETAIL	SIZE
Black/Gold	30701599	40.00	S-2XL





MASTER-LITE LEATHER PATCH VEST

Full-length leather shooting patch • 100% cotton body construction • Mesh sides for ventilation • Two-way front zipper • Four large front shell pockets • Bar tacks at all stress points • Side tab adjustments • Sewn-in REACTAR G2 pad system • Split shoulder for ease of movement • Chest pocket • Towel loop

DESCRIPTION	RIGHT/LEFT	CODE NUMBER	SUGGESTED RETAIL	SIZE
Black/Orange	Right-Hand	30503099	220.00	S-3XL

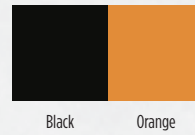

TRAPPER CREEK MESH SHOOTING VEST

100% poly mesh body for ventilation • Full-length 100% garment washed cotton twill shooting patch • Internal REACTAR G2 pad pocket (pad sold separately) • Four large shell pockets • Bar tacks at stress points • Side tab adjustments • Large rear pocket for hulls and other gear

	DESCRIPTION	RIGHT/LEFT	CODE NUMBER	SUGGESTED RETAIL	SIZE
A	RTX/Brown	Right-Hand	30502624	70.00	S-3XL
B	Tan/Black	Right-Hand	30502689	65.00	S-3XL
	Tan/Black	Left-Hand	30503689	65.00	M-2XL
C	Sage/Black	Right-Hand	30502654	65.00	S-3XL
D	Clay/Black	Right-Hand	30502668	65.00	S-3XL
E	Sand/Black	Right-Hand	30502628	65.00	S-3XL
	Sand/Black	Left-Hand	30503628	65.00	M-2XL

NEW MODEL



Realtree Xtra Brown Tan Black



Sage Black Clay Black Sand Black



TRAPPER CREEK MESH HALF VEST

Adjustable polyester web belt with speed buckle • Double, oversized shell pockets • Mesh shell pouch with zip bottom for easy emptying

DESCRIPTION	CODE NUMBER	SUGGESTED RETAIL	SIZE
Sage/Black	30900754	47.00	One Size
Black/Black	30900798	47.00	One Size

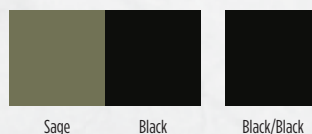



SANTA FE PRO SHOOTING VEST

Crazy Horse Leather full-length shooting patch and trim • Cotton twill and polyester mesh body for ventilation • Two-way front zipper • Four large front shell pockets • Bar tacks at all stress points • Back tab adjustments • Large back pocket for empties or other gear • Sewn-in REACTAR G2 pad system • Elastic choke tube loops • Split shoulder for ease of movement • 100% polyester mesh • Interior security pocket

DESCRIPTION	RIGHT/LEFT	CODE NUMBER	SUGGESTED RETAIL	SIZE
Sage/Oak	Right-Hand	30504154	245.00	S-2XL

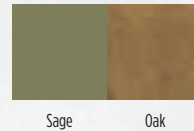

CROSSOVER SHOOTING VEST

Full-length leather shooting patch and trim • Cotton twill and polyester mesh body for ventilation • Two-way front zipper • Four large front shell pockets • Back tab adjustments • Large back pocket for empties or other gear • Sewn-in REACTAR G2 pad pocket (pad sold separately) • 100% polyester mesh Realtree Xtra® camo on face, pockets, belt and yoke makes it ideal for wear on the range or in the field

DESCRIPTION	RIGHT/LEFT	CODE NUMBER	SUGGESTED RETAIL	SIZE
RTX/Leather	Right-Hand	30503224	215.00	S-2XL

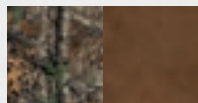

Realtree Xtra Leather



NEW



DELUXE MESH SHOOTING VEST

Twill full-length shooting patch • Mesh body for ventilation • Two-way front zipper • Four large front shell pockets • Bar tacks at all stress points • Side tab adjustments • Large back pocket for empties or other gear • Sewn-in REACTAR G2 pad system • Split shoulder for ease of movement • 60% cotton/40% poly twill • 100% polyester mesh

DESCRIPTION	RIGHT/LEFT	CODE NUMBER	SUGGESTED RETAIL	SIZE
Black/Tan	Right-Hand	30501799	140.00	S-3XL
Black/Tan	Left-Hand	30502799	140.00	M-2XL

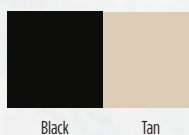



RHETT SHOOTING VEST

Full-length 100% cotton garment-washed shooting patches on right and left shoulders with sewn-in REACTAR G2 pad pockets (pad sold separately) • 100% polyester mesh body for ventilation • Choke tube loops • Two-way front zipper • Bellows shell pockets • Side tab adjustments • Large back pocket for empties or other gear • Inside security pocket

	DESCRIPTION	RIGHT/LEFT	CODE NUMBER	SUGGESTED RETAIL	SIZE
A	Olive/Tan	Ambidextrous	30502974	70.00	S-3XL
B	Charcoal/Tan	Ambidextrous	30502979	70.00	S-3XL

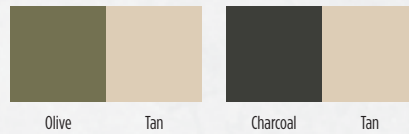

SUMMIT SHOOTING VEST

Durable polyester shooting patches on right and left shoulders with sewn-in REACTAR G2 pad pockets (pad sold separately) • 100% polyester mesh body for ventilation • Two-way front zipper • Bellows shell pockets • Side tab adjustments • Large back pocket for empties or other gear

	DESCRIPTION	RIGHT/LEFT	CODE NUMBER	SUGGESTED RETAIL	SIZE
A	Tan/Chocolate/Taupe	Ambidextrous	30503168	85.00	S-3XL
B	Black/Gray/Charcoal	Ambidextrous	30503179	85.00	S-3XL
C	Tan/Green/Dark Gray	Ambidextrous	30503184	85.00	S-3XL

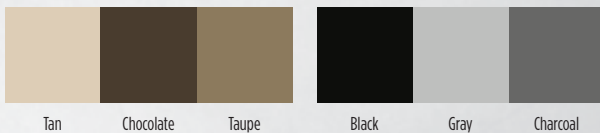



SAHARA SHOOTING VEST FOR HER

Fun and stylish safari print with accent colors • 100% cotton twill full-length shooting patches on right and left shoulders with sewn-in REACTAR G2 pad pockets (pad sold separately) • 100% polyester mesh body for ventilation • Two-way front zipper • Bellows shell pockets • Side tab adjustments • Large back pocket for empties or other gear • Inside security pocket • Women's cut

	DESCRIPTION	RIGHT/LEFT	CODE NUMBER	SUGGESTED RETAIL	SIZE
A	Black/Zebra/White	Ambidextrous	30506839	88.00	S-2XL
B	Brown/Leopard/Purple	Ambidextrous	30506838	88.00	S-2XL

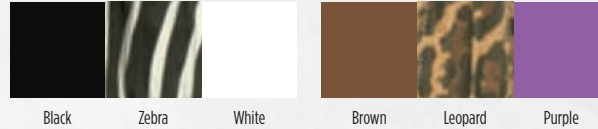

SUMMIT SHOOTING VEST FOR HER

Durable polyester shooting patches on right and left shoulders with sewn-in REACTAR G2 pad pockets (pad sold separately) • 100% polyester mesh body for ventilation • Two-way front zipper • Bellows shell pockets • Side tab adjustments • Large back pocket for empties or other gear • Women's cut

	DESCRIPTION	RIGHT/LEFT	CODE NUMBER	SUGGESTED RETAIL	SIZE
A	Cream/Plum/Dark Gray	Ambidextrous	30507191	85.00	S-2XL
B	Tan/Sage/Pink	Ambidextrous	30507154	85.00	S-2XL
C	Tan/Brown/Cinnamon	Ambidextrous	30507188	85.00	S-2XL

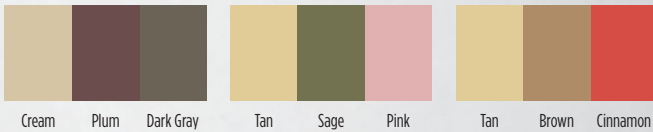

NEW MODEL

SPORTER II SHOOTING VEST FOR HER

Twill full-length shooting patch • Mesh body for ventilation • Two-way front zipper • Two large front shell pockets • Bar tacks at all stress points • Side tab adjustments • Large back pocket for empties or other gear • Sewn-in REACTAR G2 pad system (pad sold separately) • Split shoulder for ease of movement • 60% cotton/40% poly twill • 100% polyester mesh • Women's cut

	DESCRIPTION	RIGHT/LEFT	CODE NUMBER	SUGGESTED RETAIL	SIZE
A	Sage/Tan/Pink	Ambidextrous	30506754	85.00	S-2XL
B	Brown/Pink/Tan	Ambidextrous	30506788	85.00	S-2XL
C	Sage/Tan/RTAPP	Ambidextrous	30506726	85.00	S-2XL

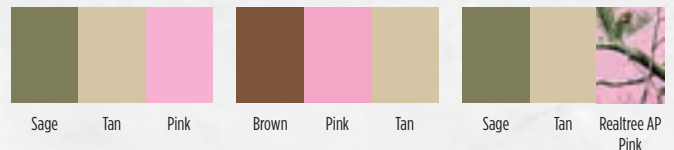

VESTS FOR EVERY SHOOTER.

We offer stylish, functional shooting vests for every member of the family. Well constructed from high quality materials, these vests are sure to last season after season.



JUNIOR TRAPPER CREEK SHOOTING VEST

100% poly mesh body for ventilation • Full-length 100% garment washed cotton twill shooting patch • Internal REACTAR G2 pad pocket (pad sold separately) • Two-way front zipper • Large shell pockets • Side tab adjustments • Large back pocket for empties or other gear • Inside security pocket • Buckmark and Claymaster embroidery
SIZES S (6-8), M (10-12), L (14-16), XL (18-20), 2XL (22)



	DESCRIPTION	RIGHT/LEFT	CODE NUMBER	SUGGESTED RETAIL	SIZE
A	Sage/Black	Ambidextrous	30505454	58.00	S-2XL
B	Black/Tan	Ambidextrous	30505489	58.00	S-2XL



Sage Black Black Tan



JUNIOR TRAPPER CREEK SHOOTING VEST FOR HER

100% poly mesh body for ventilation • Full-length 100% garment washed cotton twill shooting patch • Internal REACTAR G2 pad pocket (pad sold separately) • Two-way front zipper • Large shell pockets • Side tab adjustments • Large back pocket for empties or other gear • Inside security pocket • Buckmark and Claymaster embroidery
SIZES S (6-8), M (10-12), L (14-16), XL (18-20), 2XL (22)

	DESCRIPTION	RIGHT/LEFT	CODE NUMBER	SUGGESTED RETAIL	SIZE
A	Black/Zebra/White	Ambidextrous	30505439	58.00	S-2XL
B	Sage/Pink/Sage	Ambidextrous	30505444	58.00	S-2XL



Black Zebra White Sage Pink Sage





BADGER CREEK SHOOTING SHIRT

100% garment-washed cotton • Internal REACTAR G2 pad pocket behind shooting patch (pad sold separately) • Mesh-lined turbo vent back for maximum air circulation • Seven-button placket front • Button-down collar • Left front patch chest pocket

	DESCRIPTION	CODE NUMBER	SUGGESTED RETAIL	SIZE
A	Sand	30103448	55.00	S-XL
			60.00	2XL-3XL
B	Pine	30103454	55.00	S-XL
			60.00	2XL-3XL
	Brown	30103488	55.00	S-XL
			60.00	2XL-3XL
	Black	30103499	55.00	S-XL
			60.00	2XL-3XL



HIGHLINE SHOOTING SHIRTS

Moisture wicking 73% polyester, 22% rayon, 5% spandex blend fabric • Comfortable and stretches to provide superb freedom of movement • Internal REACTAR G2 pad pocket (pad sold separately) **POLO** Three-button front placket • Polo collar **1/4 ZIP** 1/4 zip front placket • Stand-up collar

	NEW 2015	DESCRIPTION	CODE NUMBER	SUGGESTED RETAIL	SIZE
POLO SHIRT					
A	•	Heather	30107069	65.00	S-XL
				70.00	2XL-3XL
B		Coffee	30107088	65.00	S-XL
				70.00	2XL-3XL
		Gray	30107079	65.00	S-XL
				70.00	2XL-3XL
1/4 ZIP SHIRT					
	•	Heather	30107169	70.00	S-XL
				75.00	2XL-3XL
		Coffee	30107188	70.00	S-XL
				75.00	2XL-3XL
C		Gray	30107179	70.00	S-XL
				75.00	2XL-3XL



NEW COLOR

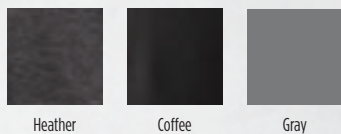

MOJAVE SHOOTING SHIRT FOR HER

100% polyester moisture-wicking pique fabric is perfect for hot weather • OdorSmart™ technology helps to control human odor • Excellent moisture transfer • Crew neck • Claymaster and Buckmark logo embroidery • Women's cut



DESCRIPTION	CODE NUMBER	SUGGESTED RETAIL	SIZE
Pink	30104341	50.00	S-2XL

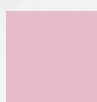

Pink





BALLISTIC INSULATED SHOOTING JACKET

Pre-Vent waterproof, windproof, breathable fabric • Warm insulation • Double microsuede shooting patches accommodate both right- and left-handed shooters • REACTAR G2 pad pockets (pad sold separately) • Two bellows pockets with magnetic fasteners to hold flaps open or closed • T-cuffs • Stand-up, zip-through collar • Brushed tricot lining • Two-way front zipper • Neoprene cuffs with hook and loop adjustment tabs • Drawcord bottom • Buckmark logo embroidery

DESCRIPTION	CODE NUMBER	SUGGESTED RETAIL	SIZE
Charcoal/Brown	30401479	200.00	S-XL
		204.00	2XL-3XL

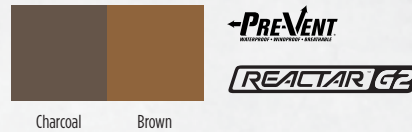

BALLISTIC INSULATED SHOOTING JACKET FOR HER

Pre-Vent waterproof, windproof, breathable fabric • Warm insulation • Double microsuede shooting patches accommodate both right- and left-handed shooters • REACTAR G2 pad pockets (pad sold separately) • Two bellows pockets with magnetic fasteners to hold flaps open or closed • T-cuffs • Stand-up, zip-through collar • Brushed tricot lining • Two-way front zipper • Neoprene cuffs with hook and loop adjustment tabs • Drawcord bottom • Buckmark logo embroidery

DESCRIPTION	CODE NUMBER	SUGGESTED RETAIL	SIZE
Charcoal/Rose	30401469	200.00	S-2XL



REACTAR G2 PAD • REACTAR G2 PAD AND HARNESS

PAD Exclusive REACTAR G2 pad (REcoil ACTION ARrestor) absorbs recoil on the inside of vest, jacket or shirt without altering appearance or increasing length of pull • Uses patented, environmentally-friendly Impact Gel™ to reduce peak recoil • Only 8mm thick • Lightweight • Flexible to form to the body • Dimensions: 3-3/4" W x 7" L **PAD AND HARNESS** Includes REACTAR G2 pad • Heavy-duty 500 denier Cordura® • Reversible for use by right- or left-handed shooters • Elastic strap with buckle size adjustment

	CODE NUMBER	SUGGESTED RETAIL	SIZE
A	REACTAR G2 PAD		
	309013	30.00	One Size Fits Most
B	REACTAR G2 PAD AND HARNESS		
	309011	60.00	One Size Fits Most





DURA-LITE SHOOTING GLOVE

Durable yet sensitive digital goatskin leather palm and fingers for enhanced grip
 • Supple Cabretta sheepskin leather on fingers and thumb for added dexterity
 • Perforated vents keep hands cool and comfortable • Stretchy and breathable Lycra® inserts at knuckle articulation points • Adjustable hook and loop closure

DESCRIPTION	CODE NUMBER	SUGGESTED RETAIL	SIZE
Black	30701699	70.00	S-2XL

MESH BACK SHOOTING GLOVE

Lightweight, soft brushed synthetic suede • Stretch mesh back for comfortable fit and enhanced air circulation • Hook and loop closure tab with Claymaster embroidery allows for adjustable, comfortable fit • Washable

	DESCRIPTION	CODE NUMBER	SUGGESTED RETAIL	SIZE
A	Tan/Black	30701188	38.00	S-2XL
B	Black	30701190	38.00	S-2XL

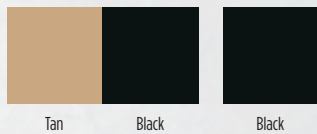

Tan Black Black



**TRAPPER CREEK SHOOTING GLOVE
 TRAPPER CREEK SHOOTING GLOVE FOR HER**

Lightweight, soft brushed synthetic suede • Stretch mesh back for comfortable fit and enhanced air circulation • Comfortable pull-on style • Washable

	DESCRIPTION	CODE NUMBER	SUGGESTED RETAIL	SIZE
A	Charcoal/Black	30701379	40.00	S-2XL
B	White/Fuchsia	30701447	40.00	S-2XL



Charcoal Black White Fuchsia

SHOOTING TOWEL

100% cotton construction • Sturdy eyelet with clip attaches to shooting vest
 • Tri-fold design is compact and unobtrusive • Buckmark embroidery

	DESCRIPTION	CODE NUMBER	SUGGESTED RETAIL	SIZE
A	Black/Gold	309009991	15.00	13 x 22
B	Black/Pink	309009992	15.00	13 x 22



Black Gold Black Pink





NEW

ROCKWELL
CLOSURE Flexfit

	DESCRIPTION	CODE NUMBER	SUGGESTED RETAIL
A	Black S/M	308709992	25.00
	Black L/XL	308709994	
B	Heather S/M	308709492	
	Heather L/XL	308709494	



NEW

TARTAN
CLOSURE Flexfit

DESCRIPTION	CODE NUMBER	SUGGESTED RETAIL
Black Plaid S/M	308708992	25.00
Black Plaid L/XL	308708994	



FLASH BACK
CLOSURE Flexfit

DESCRIPTION	CODE NUMBER	SUGGESTED RETAIL
Bubble Camo S/M	308704292	25.00
Bubble Camo L/XL	308704294	



DOUGLAS
CLOSURE Flexfit

DESCRIPTION	CODE NUMBER	SUGGESTED RETAIL
Olive Plaid S/M	308705842	25.00
Olive Plaid L/XL	308705844	



CORONADO
CLOSURE Flexfit

	DESCRIPTION	CODE NUMBER	SUGGESTED RETAIL
A	Charcoal S/M	308007892	25.00
	Charcoal L/XL	308007894	
B	Chocolate S/M	308007982	
	Chocolate L/XL	308007984	
C	Black S/M	308007992	
	Black L/XL	308007994	



DYLAN
CLOSURE Flexfit

	DESCRIPTION	CODE NUMBER	SUGGESTED RETAIL
A	Black/Gold S/M	308706732	25.00
	Black/Gold L/XL	308706734	
B	Black/Khaki S/M	308706582	
	Black/Khaki L/XL	308706584	



COLSTRIP MESH BACK
CLOSURE Flexfit

	DESCRIPTION	CODE NUMBER	SUGGESTED RETAIL
A	Charcoal S/M	308702892	25.00
	Charcoal L/XL	308702894	
B	Dark Brown S/M	308702982	
	Dark Brown L/XL	308702984	



NEW
STERLING
CLOSURE Hook and Loop Back

	DESCRIPTION	CODE NUMBER	SUGGESTED RETAIL
A	Black	308011991	18.00
B	Sage	308011541	
C	Olive	308011841	
D	Gray	308011691	



NEW
BIG BUCKMARK TWO-TONE
CLOSURE Hook and Loop Back

	DESCRIPTION	CODE NUMBER	SUGGESTED RETAIL
A	Black/Gray	308014991	20.00
B	Navy/Cream	308014951	
C	Brown/Tan	308014881	



BOZEMAN MESH BACK
CLOSURE Hook and Loop Back

	DESCRIPTION	CODE NUMBER	SUGGESTED RETAIL
A	Black	308357991	18.00
B	Brown	308357981	
C	Olive	308357841	
D	Orange	308357721	



NEW
STACK-LITE
CLOSURE Hook and Loop Back

	DESCRIPTION	CODE NUMBER	SUGGESTED RETAIL
A	White	308290471	18.00
B	Charcoal	308290891	
C	Black	308290991	



NEW
COOPER
CLOSURE Hook and Loop Back

	DESCRIPTION	CODE NUMBER	SUGGESTED RETAIL
A	Brown	308249881	20.00
B	Sage	308249541	



NEW
OVER/UNDER
CLOSURE Hook and Loop Back

	DESCRIPTION	CODE NUMBER	SUGGESTED RETAIL
A	Olive	308248841	18.00
B	Brown	308248881	
C	Black	308248991	



NEW

RHINO

CLOSURE Hook and Loop Back

DESCRIPTION	CODE NUMBER	SUGGESTED RETAIL
Brown	308378881	18.00



STRAW WITH REPEL-TEX BRIM

CLOSURE Hook and Loop Back

DESCRIPTION	CODE NUMBER	SUGGESTED RETAIL
Straw/Brown	308106881	28.00



NEW

CADDIS

CLOSURE Snap Back

DESCRIPTION	CODE NUMBER	SUGGESTED RETAIL
Sage/Brown	308250541	18.00



NEW

BECKER

CLOSURE Hook and Loop Back

DESCRIPTION	CODE NUMBER	SUGGESTED RETAIL
Brown	308251881	20.00



DURA-WAX WITH CORPORATE LOGO

CLOSURE Hook and Loop Back

	DESCRIPTION	CODE NUMBER	SUGGESTED RETAIL
A	Olive	308412381	23.00
B	Brown	3084121	



DURA-WAX WITH 3D BUCKMARK

CLOSURE Hook and Loop Back

	DESCRIPTION	CODE NUMBER	SUGGESTED RETAIL
A	Brown	308412881	23.00
B	Olive	308412941	



LITE WAX WITH CORPORATE LOGO

CLOSURE Hook and Loop Back

DESCRIPTION	CODE NUMBER	SUGGESTED RETAIL
Khaki	308412581	23.00



REPEL-TEX CLOTH TWO-TONE WITH 3D BUCKMARK

CLOSURE Hook and Loop Back

DESCRIPTION	CODE NUMBER	SUGGESTED RETAIL
Acorn/Olive	308110341	22.00



LIBERTY WAX

CLOSURE Hook and Loop Back

	DESCRIPTION	CODE NUMBER	SUGGESTED RETAIL
A	Dark Brown	308776881	23.00
B	Brown	308776681	



BAYOU MESH BACK
CLOSURE Hook and Loop Back

	DESCRIPTION	CODE NUMBER	SUGGESTED RETAIL
A	AllTerrain	308238091	18.00
B	Brown/Tan	308238891	
C	Charcoal/Tan	308238981	



DIGI-CAMO DESERT
CLOSURE Hook and Loop Back

CODE NUMBER	SUGGESTED RETAIL
308506291	18.00



BUSHWACKER
CLOSURE Hook and Loop Back

DESCRIPTION	CODE NUMBER	SUGGESTED RETAIL
RTX/Brown	308237211	23.00



NEW
FLASHBACK MESH
CLOSURE Snap Back

DESCRIPTION	CODE NUMBER	SUGGESTED RETAIL
Bubble Camo	308174421	23.00



NEW
MESH-LITE
CLOSURE Hook and Loop Back

DESCRIPTION	CODE NUMBER	SUGGESTED RETAIL
RTX	308160211	20.00



HELL'S CANYON
CLOSURE Hook and Loop Back

	DESCRIPTION	CODE NUMBER	SUGGESTED RETAIL
A	Black	308147991	18.00
B	MOINF	308147201	20.00
C	RTX	308147241	



BIG BUCKMARK AND CAMO
CLOSURE Hook and Loop Back

	DESCRIPTION	CODE NUMBER	SUGGESTED RETAIL
A	MOINF	308204201	20.00
B	RTX	308204241	



BREEZE MESH BACK
CLOSURE Hook and Loop Back

	DESCRIPTION	CODE NUMBER	SUGGESTED RETAIL
A	MOINF/Tan	308325201	18.00
B	RTX/Black	308325242	



DIRTY BIRD
CLOSURE Hook and Loop Back

	DESCRIPTION	CODE NUMBER	SUGGESTED RETAIL
A	Black	308131991	15.00
B	MOSGB	308133251	20.00
C	RTM5	308133761	



BOZEMAN MESH BACK CAMO
CLOSURE Hook and Loop Back

	DESCRIPTION	CODE NUMBER	SUGGESTED RETAIL
A	MOINF	308357201	20.00
B	RTX	308357241	



DAKOTA CANVAS AND CAMO
CLOSURE Hook and Loop Back

	DESCRIPTION	CODE NUMBER	SUGGESTED RETAIL
A	Loden/RTX	308358241	23.00
B	Tan/RTX	308358581	



RIMFIRE
CLOSURE Hook and Loop Back

	NEW 2015	DESCRIPTION	CODE NUMBER	SUGGESTED RETAIL
A		MOBL	308379191	20.00
B		MOSGB	308379251	
C	•	MOBUC	308379281	
D		RTM5	308379761	
E		RTM1	308379231	
F		RTX	308379241	
G		RTSNW	308379271	



SAFETY WITH 3D BUCKMARK
CLOSURE Hook and Loop Back

DESCRIPTION	CODE NUMBER	SUGGESTED RETAIL
Blaze/Black	30840501	18.00



POLSON BLAZE MESH BACK
CLOSURE Hook and Loop Back

DESCRIPTION	CODE NUMBER	SUGGESTED RETAIL
Blaze/RTX	308134011	18.00



SAFETY PHEASANTS FOREVER EMBROIDERY
CLOSURE Hook and Loop Back

DESCRIPTION	CODE NUMBER	SUGGESTED RETAIL
Blaze	308126011	18.00



NEW FLEXFIT SAFETY
CLOSURE Flexfit

DESCRIPTION	CODE NUMBER	SUGGESTED RETAIL
Blaze S/M	308707722	25.00
Blaze L/XL	308707724	



NEW HI-VIZ BLAZE
CLOSURE Hook and Loop Back

DESCRIPTION	CODE NUMBER	SUGGESTED RETAIL
Blaze	308461591	18.00



SURE SHOT NEW
CLOSURE Flexfit

DESCRIPTION	CODE NUMBER	SUGGESTED RETAIL
Blaze	308380011	18.00



NEW LIBBY
CLOSURE Hook and Loop Back

DESCRIPTION	CODE NUMBER	SUGGESTED RETAIL
Charcoal/Khaki	308247891	20.00



NEW GEENA
CLOSURE Hook and Loop Back

DESCRIPTION	CODE NUMBER	SUGGESTED RETAIL
Olive/Magenta	308255841	25.00



NEW NADIA
CLOSURE Hook and Loop Back

DESCRIPTION	CODE NUMBER	SUGGESTED RETAIL
Gray/White	308246691	25.00



NEW SIERRA
CLOSURE Hook and Loop Back

DESCRIPTION	CODE NUMBER	SUGGESTED RETAIL
Olive/RTX	308153841	20.00



NEW
COUNTRY GIRL
CLOSURE Hook and Loop Back

DESCRIPTION	CODE NUMBER	SUGGESTED RETAIL
RTX/Pink	308183241	20.00



NEW
DIVA
CLOSURE Slide Buckle

DESCRIPTION	CODE NUMBER	SUGGESTED RETAIL
Black/Fuchsia	308363991	20.00



ATKA FOR HER
CLOSURE Hook and Loop Back

	DESCRIPTION	CODE NUMBER	SUGGESTED RETAIL
A	Sage/Pink	308240442	15.00
B	Black/Salmon	308240511	



DURA WAX W/CORPORATE LOGO FOR HER
CLOSURE Hook and Loop Back

	DESCRIPTION	CODE NUMBER	SUGGESTED RETAIL
A	Brown/Pink	308412511	23.00
B	Olive/Fuchsia	308354841	



SAHARA ANIMAL
CLOSURE Hook and Loop Back

	DESCRIPTION	CODE NUMBER	SUGGESTED RETAIL
A	Leopard/Purple	308343921	15.00
B	Zebra/Fuchsia	308343991	



CHELSIE
CLOSURE Hook and Loop Back

	DESCRIPTION	CODE NUMBER	SUGGESTED RETAIL
A	Black/Pink	308244511	20.00
B	Black/Purple	308244461	



STONEHAVEN
CLOSURE Hook and Loop Back

	DESCRIPTION	CODE NUMBER	SUGGESTED RETAIL
A	Purple	308243461	18.00
B	Teal	308243741	



SWEETHEART MESH BACK
CLOSURE Hook and Loop Back

DESCRIPTION	CODE NUMBER	SUGGESTED RETAIL
Black/Hot Pink	308239992	20.00



SWEETHEART CAMO
CLOSURE Hook and Loop Back

DESCRIPTION	CODE NUMBER	SUGGESTED RETAIL
RTX/Hot Pink	308239242	22.00



NEW BELLA BLAZE
CLOSURE Hook and Loop Back

DESCRIPTION	CODE NUMBER	SUGGESTED RETAIL
Blaze	308245011	18.00



NEW BIG BUCKMARK AND CAMO FOR HER
CLOSURE Hook and Loop Back

DESCRIPTION	CODE NUMBER	SUGGESTED RETAIL
RTX/Fuchsia	308204771	20.00



WOODLAND CAMO FOR HER
CLOSURE Leather Strap with Slide Buckle

DESCRIPTION	CODE NUMBER	SUGGESTED RETAIL
Pink	308121411	18.00



RIMFIRE FOR HER
CLOSURE Hook and Loop Back

DESCRIPTION	CODE NUMBER	SUGGESTED RETAIL
RTAPP	308379261	18.00



JEWELLED MESH BACK FOR HER
CLOSURE Hook and Loop Back

DESCRIPTION	CODE NUMBER	SUGGESTED RETAIL
Brown	308355881	18.00



JEWELLED FOR HER
CLOSURE Hook and Loop Back

DESCRIPTION	CODE NUMBER	SUGGESTED RETAIL
RTX/Brown	308355241	18.00



GUNNER FOR HER
CLOSURE Hook and Loop Back

DESCRIPTION	CODE NUMBER	SUGGESTED RETAIL
MOINF/Pink	308129202	24.00

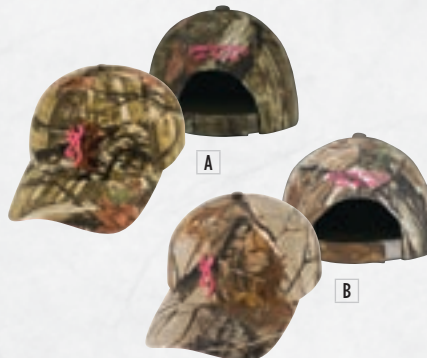

3D BUCKMARK FOR HER
CLOSURE Hook and Loop Back

	DESCRIPTION	CODE NUMBER	SUGGESTED RETAIL
A	MOINF/Fuchsia	308179202	18.00 ea.
B	RTX/Fuchsia	308179242	



ISSI FOR HER
CLOSURE Hook and Loop Back

	DESCRIPTION	CODE NUMBER	SUGGESTED RETAIL
A	MOINF/Magenta	308135201	20.00
B	RTX/Magenta	308135241	
C	Blaze/Magenta	308135011	

DISCOVER THE BROWNING CUSTOM CAP COLLECTION

Stop into your local Authorized Browning Dealer and design custom caps for your family reunion, shooting team or hunting club to stand out from the crowd, here's your chance to create your own unique Browning Buckmark cap using your favorite color scheme. You can also create special caps that show your loyalty to your local college or pro sports team. Have fun!

NEW



SUGGESTED RETAIL
25.00

CAP COLOR



BLACK 01

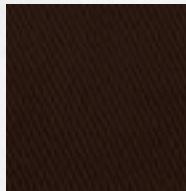

BROWN 02

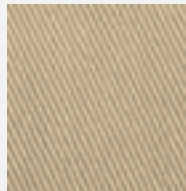

KHAKI 03



NAVY 04

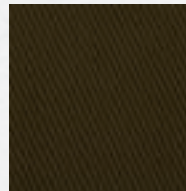

CHARCOAL 05



FUCHSIA 06



REALTREE XTRA 07

EMBROIDERY COLOR



BLACK 01



WHITE 02



GOLD 03

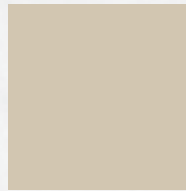

SAND 04



LIME GREEN 05



BLAZE ORANGE 06



RED 07

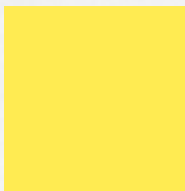

YELLOW 08



CREAM 09



BURNT ORANGE 10



PINK 11



FUCHSIA 12



ROYAL BLUE 13



NAVY BLUE 14



KENAI KNIT BEANIE

DESCRIPTION	CODE NUMBER	SUGGESTED RETAIL	SIZE
Blaze/Black Logo	308509011	15.00	One Size Fits Most

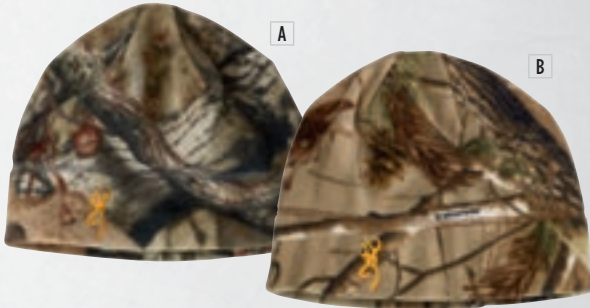
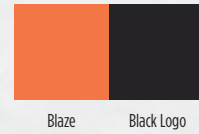

JUNEAU FLEECE BEANIE

	DESCRIPTION	CODE NUMBER	SUGGESTED RETAIL	SIZE
A	MOINF/Gold Logo	308519201	17.00	One Size Fits Most
B	RTX/Gold Logo	308519241		

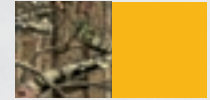

NEW

ALL SEASON REVERSIBLE BEANIE

DESCRIPTION	CODE NUMBER	SUGGESTED RETAIL	SIZE
RTX/Blaze	308511011	20.00	One Size Fits Most



QUIK-COVER BEANIE

NEW

DESCRIPTION	CODE NUMBER	SUGGESTED RETAIL	SIZE
(SHOWN IN REALTREE XTRA)			
MOSGB	308526251	20.00	One Size Fits Most
RTMS	308526761		
RTX	308526241		
MOINF	308526201		

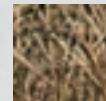

Mossy Oak Shadow Grass Blades

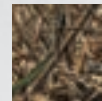

Realtree Max-5

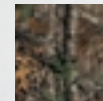

Realtree Xtra

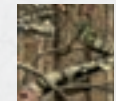

Mossy Oak Break-Up Infinity



KODIAK BEANIE

NEW

	DESCRIPTION	CODE NUMBER	SUGGESTED RETAIL	SIZE
A	Camo/Gold	308529991	25.00	One Size Fits Most
B	Camo/Fuchsia	308529771		

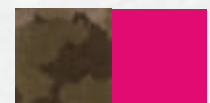
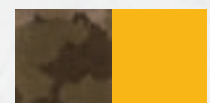

Camo Fuchsia Logo Trim



DIRTY BIRD

	DESCRIPTION	CODE NUMBER	SUGGESTED RETAIL	SIZE Inches
A	White/Pink	3922250851	15.00	8
B	White/Orange	3922250872		



DIRTY BIRD OVAL

	DESCRIPTION	CODE NUMBER	SUGGESTED RETAIL	SIZE Inches
A	RTM4/Orange	3922260522		
B	Black/Pink	3922260551	7.00	5
C	Black/Orange	3922260572		



HELL'S CANYON

	DESCRIPTION	CODE NUMBER	SUGGESTED RETAIL	SIZE Inches
A	White	3922334474		
B	Flame	3922334324	7.00	4
C	Flame/White	3922334304		



BUCKMARK FOR HER

	DESCRIPTION	COLOR	CODE NUMBER	SUGGESTED RETAIL	SIZE Inches
A	Daisy Buckmark	Black/Pink	3922080551		
B	Bouquet Buckmark	Black/Pink	3922090551	8.00	5



BUCKMARK

	DESCRIPTION	COLOR	CODE NUMBER	SUGGESTED RETAIL	SIZE Inches
A	Claymaster 3D	Orange	3922054	10.00	3-1/2
B	Deer & Skull	Black/Gold	3922080573	8.00	5
	Deer & Skull	Black/Gold	3922081573	24.00	15



BUCKMARK FAMILY

DESCRIPTION	CODE NUMBER	SUGGESTED RETAIL	SIZE Inches
MOBU/Pink	3922100014	25.00	6



BUCK HEART

	DESCRIPTION	CODE NUMBER	SUGGESTED RETAIL	SIZE Inches
A	H&H Camo	3922290614		
B	Camo	3922290620	9.00	6
C	Zebra	3922290639		
D	Hot Pink	3922290651		

BUCKMARK SOLID COLOR NEW COLORS



NEW 2015	DESCRIPTION	CODE NUMBER	SUGGESTED RETAIL	SIZE Inches
(SHOWN IN PINK)				
•	Purple	3922009616	7.00 ea.	6
•	Teal	3922007416	7.00 ea.	6
	White	3922004714	4.00 ea.	4
		3922004716	7.00 ea.	6
	Silver	3922004711	15.00 ea.	12
		3922005914	4.00 ea.	4
	Black	3922005916	7.00 ea.	6
		3922009914	4.00 ea.	4
	Pink	3922009916	7.00 ea.	6
		3922004116	7.00 ea.	6
	Lime Green	3922004111	15.00 ea.	12
		392200654	7.00 ea.	6
	Hot Pink	3922005116	7.00 ea.	6
		3922007314	4.00 ea.	4
	Gold	3922007316	7.00 ea.	6
		3922007311	15.00 ea.	12
	Chrome Silver	3922006916	7.00 ea.	6



BUCKMARK CAMO

DESCRIPTION	CODE NUMBER	SUGGESTED RETAIL	SIZE Inches
(SHOWN IN MOSSY OAK BREAK-UP INFINITY)			
Camo	3922001914	4.00 ea.	4
Camo	3922002916	7.00 ea.	6
Camo	3922002911	15.00 ea.	12
Paint-Safe, MOINF	3922281520	15.00 ea.	15
Paint-Safe, RTX	3922282420	15.00 ea.	15



BUCKMARK 3D

DESCRIPTION	CODE NUMBER	SUGGESTED RETAIL	SIZE Inches
(SHOWN IN RED/WHITE/BLUE)			
Gold	3922017316	15.00 ea.	6
Silver	3922015916		
Black	3922019916		
MOINF	3922012916		
Red/White/Blue	3922013116		

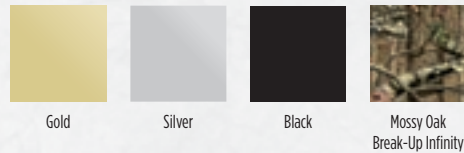

BUCKMARK SPECIALTY AND GRAPHICS

	DESCRIPTION	CODE NUMBER	SUGGESTED RETAIL	SIZE Inches
REFLECTIVE				
A	Amber	3922070642	7.00 ea.	6
B	Red	3922070661		
CARBON FIBER				
C	Charcoal	3922750689	7.00 ea.	6
FALINE SPANGLE				
D	Pink	3922220647	13.00 ea.	15
E	Silver	3922220659		
SAHARA				
F	Leopard/Purple	3922240602	7.00 ea.	6
G	Zebra/Fuchsia	3922240609		
RED/WHITE/BLUE				
H	Red/White/Blue	3922003116	7.00 ea.	6
		3922003111	15.00 ea.	12



Willie Schmidt, Host of *Pure Hunting*





Jared Wihongi, International Self-Defense Trainer

HARD CORE TACTICAL BLADES.

When the going gets tough it's time to draw a Black Label Tactical Blade. These rugged, no-nonsense knives are capable of cutting their way out of any trouble. Carry a Black Label Tactical Blade on any mission and in any environment with absolute confidence.



STOW-AWAY SURVIVAL NEW

TYPE Fixed compound curve with false edge **BLADE** Hollow ground 440C stainless steel • Matte black finish for smoother cutting and added corrosion resistance • Splitting edge on spine **HANDLE** Full-tang construction • Deeply sculpted black and tan G-10 scales • Coin-slotted screws provide access to concealed cavity containing a T-handled diamond wire survival saw and knife sharpener **SHEATH** Canvas with built-in lanyard hole **ORIGIN** Made in Italy

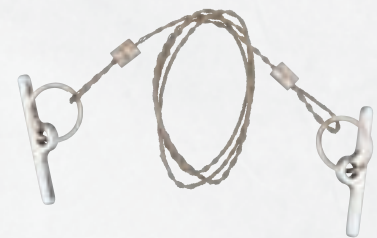

T-handled diamond wire survival saw stows in a concealed cavity inside the handle.

MODEL	OVERALL LENGTH	BLADE LENGTH	CODE NUMBER	SUGGESTED RETAIL
169BL	13-3/4	8-3/8	320169BL	265.00

SHADOWFAX

TYPE Fixed modified drop point with false edge **BLADE** Hollow ground satin finish 154CM stainless steel **HANDLE** Full-tang construction • Black G-10 scales **SHEATH** Blade-Tech™ molded polymer with Tek-Lok™ belt clip easily adjusts for carry angle and belt loop width **ORIGIN** Made in the USA



MODEL	OVERALL LENGTH	BLADE LENGTH	CODE NUMBER	SUGGESTED RETAIL
104BL	9	4-5/8	320104BL	306.00

BOOT DAGGER

TYPE Fixed double edged dagger **BLADE** Hollow ground satin finish 154CM stainless steel **HANDLE** Full-tang construction • Black G-10 scales **SHEATH** Blade-Tech™ molded polymer with Tek-Lok™ belt clip easily adjusts for carry angle and belt loop width **ORIGIN** Made in the USA

MODEL	OVERALL LENGTH	BLADE LENGTH	CODE NUMBER	SUGGESTED RETAIL
102BL	8-1/2	3-15/16	320102BL	208.00



ARBITRATOR

TYPE Fixed false edge tactical **BLADE** Hollow ground satin finish 154CM stainless steel **HANDLE** Full-tang construction • Black G-10 scales **SHEATH** Blade-Tech™ molded polymer with Tek-Lok™ belt clip easily adjusts for carry angle and belt loop width **ORIGIN** Made in the USA

MODEL	OVERALL LENGTH	BLADE LENGTH	CODE NUMBER	SUGGESTED RETAIL
103BL	10-3/4	5-1/2	320103BL	208.00





VOLATILE

TYPE Fixed double edged push dagger **BLADE** Hollow ground satin finish 154CM stainless steel **HANDLE** Full-tang construction • Black G-10 scales **SHEATH** Blade-Tech™ molded polymer with Tek-Lok™ belt clip easily adjusts for carry angle and belt loop width **ORIGIN** Made in the USA

MODEL	OVERALL LENGTH	BLADE LENGTH	CODE NUMBER	SUGGESTED RETAIL
108BL	5-9/16	4	320108BL	183.00

PERFECT STORM ASSIST

TYPE Folding spear point **BLADE** Hollow ground satin finish 154CM stainless steel **HANDLE** Robust liner lock construction • Black G-10 scales • Four-way adjustable tactical pocket clip **FEATURES** Assisted opening design **ORIGIN** Made in the USA

MODEL	OVERALL LENGTH	BLADE LENGTH	CODE NUMBER	SUGGESTED RETAIL
138BL	9-1/8	3-5/8	320138BL	244.00



PERFECT STORM

TYPE Folding tanto **BLADE** Hollow ground black oxide coated 154CM stainless steel **HANDLE** Robust liner lock construction • Black G-10 scales • Four-way adjustable tactical pocket clip **ORIGIN** Made in the USA

MODEL	OVERALL LENGTH	BLADE LENGTH	CODE NUMBER	SUGGESTED RETAIL
105BL	9-9/16	3-7/8	320105BL	220.00

HELL FIRE

TYPE Folding tanto **BLADE** Hollow ground black oxide coated 154CM stainless steel with flipper **HANDLE** Robust liner lock construction • Black G-10 scales • Four-way adjustable tactical pocket clip **ORIGIN** Made in the USA

MODEL	OVERALL LENGTH	BLADE LENGTH	CODE NUMBER	SUGGESTED RETAIL
100BL	8-1/16	3-9/16	320100BL	205.00



UNDISPUTED

TYPE Folding deep belly **BLADE** Hollow ground 154CM stainless steel **HANDLE** Robust liner lock construction • Black G-10 scales • Four-way adjustable tactical pocket clip **ORIGIN** Made in the USA

MODEL	OVERALL LENGTH	BLADE LENGTH	CODE NUMBER	SUGGESTED RETAIL
107BL	7-3/4	3-1/8	320107BL	202.00

TRIP WIRE

TYPE Highly-modified spear point **BLADE** N690Co stainless steel • False edge and chopping grind on spine • Partially serrated edge • Black oxide finish **HANDLE** Ribbed G-10 grip scales • Built-in 3-position wire cutting system **SHEATH** Nylon with MOLLE compatible straps that attach to web gear or belt **ORIGIN** Made in Italy

MODEL	OVERALL LENGTH	BLADE LENGTH	CODE NUMBER	SUGGESTED RETAIL
140BL	11-5/8	6	320140BL	306.00



Integrated wire cutter allows user to cut a variety of wire diameters.



SHOCK 'N AWESOME **NEW**

TYPE Tactical tomahawk **BLADE** Hot forged, black powder coated 1055 tool steel • Curved penetration spike **HANDLE** One-piece with spiked pommel • Checkered G-10 scales • Lanyard hole **SHEATH** Blade-Tech™ molded polymer with MOLLE compatible attachment system that easily adjusts for carry angle

MODEL	OVERALL LENGTH	BLADE LENGTH	CODE NUMBER	SUGGESTED RETAIL
170BL	13	2-5/8	320170BL	133.00

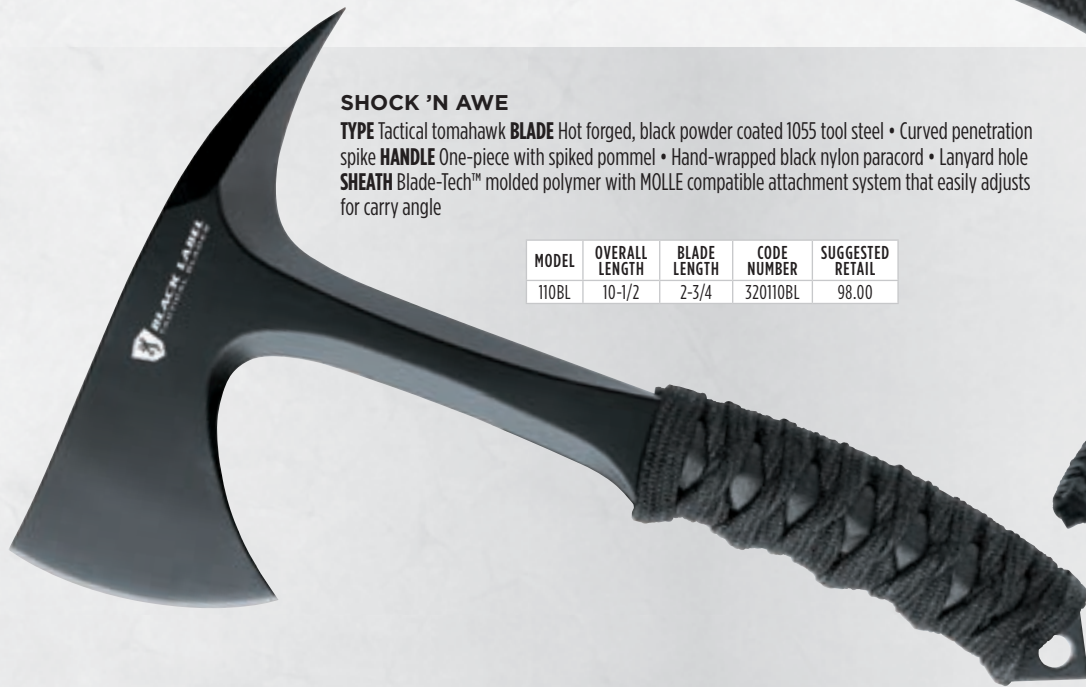

SHOCK 'N AWE

TYPE Tactical tomahawk **BLADE** Hot forged, black powder coated 1055 tool steel • Curved penetration spike **HANDLE** One-piece with spiked pommel • Hand-wrapped black nylon paracord • Lanyard hole **SHEATH** Blade-Tech™ molded polymer with MOLLE compatible attachment system that easily adjusts for carry angle

MODEL	OVERALL LENGTH	BLADE LENGTH	CODE NUMBER	SUGGESTED RETAIL
110BL	10-1/2	2-3/4	320110BL	98.00



Polymer belt sheath included with the Shock 'N Awe has thumb operated safety bail for secure carry.



A

B

TNT **NEW**

TYPE Folding blade **BLADE** 440A stainless steel **HANDLE** Black or tan G-10 **FEATURES** Lanyard eyelet • Flush fasteners • Thumb window opening in blade • Ultra-thin construction of the knife makes it slide easily into the pocket without adding excess bulk

MODEL	DESCRIPTION	OVERALL LENGTH	BLADE LENGTH	CODE NUMBER	SUGGESTED RETAIL
A	171 Black	4-5/8	1-5/8	320171BL	18.00
B	172 Tan	4-5/8	1-5/8	320172BL	18.00

NO BOUNDARIES **NEW**

TYPE Folding modified drop point **BLADE** Hollow ground 8Cr13MoV stainless steel • Blood groove • Titanium finish • Ambidextrous thumbstud **HANDLE** Robust liner lock construction • Sculpted G-10 scales • 3-way tactical pocket clip • Color matched titanium finish • Flipper

MODEL	DESCRIPTION	OVERALL LENGTH	BLADE LENGTH	CODE NUMBER	SUGGESTED RETAIL
A	168BL Black	8	3-3/4	320168BL	38.00
B	167BL Tan	8	3-3/4	320167BL	38.00



PANDEMONIUM FIXED BLADE

TYPE Fixed unique modified tanto **BLADE** Bead blasted 440 stainless steel **HANDLE** Full-tang construction • Black G-10 scales **SHEATH** Blade-Tech™ molded polymer with Tek-Lok™ belt clip easily adjusts for carry angle and belt loop width

MODEL	OVERALL LENGTH	BLADE LENGTH	CODE NUMBER	SUGGESTED RETAIL
126BL	8-5/8	4-1/4	320126BL	61.00

PANDEMONIUM FOLDER

TYPE Folding unique modified tanto **BLADE** Hollow ground 440 stainless steel • Black oxide finish • Thumbstud **HANDLE** Textured black G-10 scales • Four-way adjustable tactical pocket clip

MODEL	OVERALL LENGTH	BLADE LENGTH	CODE NUMBER	SUGGESTED RETAIL
124BL	7-3/4	3-1/2	320124BL	33.00



FIRST PRIORITY

TYPE Fixed tanto **BLADE** Hollow ground black oxide coated 440 stainless steel **HANDLE** Full-tang construction • Hand-laced green and tan digital camo paracord with knotted wrist lanyard • Lanyard hole **SHEATH** Blade-Tech™ molded polymer with Tek-Lok™ belt clip easily adjusts for carry angle and belt loop width

MODEL	OVERALL LENGTH	BLADE LENGTH	CODE NUMBER	SUGGESTED RETAIL
130BL	7-1/8	2-7/8	320130BL	61.00

COMMITTED

TYPE Fixed deep belly drop point **BLADE** Hollow ground 8Cr13MoV stainless steel • Partially serrated edge **HANDLE** Full-tang construction • Textured olive drab G-10 scales • Lanyard hole **SHEATH** Blade-Tech™ molded polymer with Tek-Lok™ belt clip easily adjusts for carry angle and belt loop width

MODEL	OVERALL LENGTH	BLADE LENGTH	CODE NUMBER	SUGGESTED RETAIL
163BL	10-1/4	5-3/8	320163BL	86.00



POINT BLANK

TYPE Fixed clip point **BLADE** 440 stainless steel • Bead blasted finish on leather handle model • Black oxide finish on black handle model **HANDLE** Hidden tang construction • Stacked leather or black G-10 handle **SHEATH** Blade-Tech™ molded polymer with Tek-Lok™ belt clip easily adjusts for carry angle and belt loop width

MODEL	DESCRIPTION	OVERALL LENGTH	BLADE LENGTH	CODE NUMBER	SUGGESTED RETAIL
A	112BL Leather	10-3/8	6	320112BL	73.00
B	111BL G-10	10-3/8	6	320111BL	73.00



BACKLASH

TYPE Fixed double edged **BLADE** Hollow ground 5Cr15MoV stainless steel • Titanium finish **HANDLE** CNC machined black G-10 • Stainless steel pommel and handguard • Titanium finish **SHEATH** Blade-Tech™ molded polymer with Tek-Lok™ belt clip easily adjusts for carry angle and belt loop width

MODEL	OVERALL LENGTH	BLADE LENGTH	CODE NUMBER	SUGGESTED RETAIL
145BL	10	5-1/2	320145BL	66.00

RAIL SYSTEM

TYPE Fixed double edged **BLADE** Hollow ground 5Cr15MoV stainless steel **HANDLE** Anodized aluminum **SHEATH** Blade-Tech™ molded polymer sheath attaches to any MIL-STD 1913 accessory rail • This patented design by Kelly Van Orden of Battle Blades adds a whole new dimension to the tactical firearm/knife platform (MIL-STD 1913 rail section as shown is not included)



MODEL	OVERALL LENGTH	BLADE LENGTH	CODE NUMBER	SUGGESTED RETAIL
150BL	10	5-1/2	320150BL	86.00

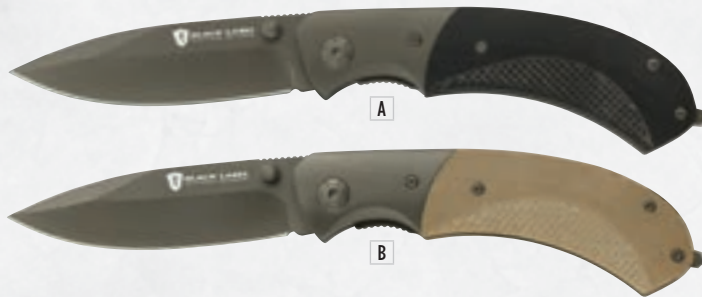

CHECKMATE

TYPE Folding false edge spear point **BLADE** Hollow ground 8Cr13MoV stainless steel • Titanium finish • Thumbstud **HANDLE** Robust liner lock construction • Checkered G-10 scales • Tactical pocket clip • Titanium finish on bolsters and pocket clip **FEATURES** Hardened glass breaking point

	MODEL	DESCRIPTION	OVERALL LENGTH	BLADE LENGTH	CODE NUMBER	SUGGESTED RETAIL
A	143BL	Black	8-1/4	3-1/2	320143BL	44.00
B	144BL	Coyote Tan	8-1/4	3-1/2	320144BL	44.00

ASSOCIATE

TYPE Folding spear point **BLADE** Hollow ground 8Cr13MoV stainless steel **HANDLE** Unique George Sessions' patented frame lock construction • Carbon fiber scales • Tactical pocket clip

MODEL	OVERALL LENGTH	BLADE LENGTH	CODE NUMBER	SUGGESTED RETAIL
164BL	6-7/8	2-7/8	320164BL	33.00



INTEGRITY

TYPE Folding tanto **BLADE** Hollow ground 440 stainless steel • Titanium finish • Thumbstud **HANDLE** Robust liner lock construction • Textured black G-10 scales • Four-way adjustable tactical pocket clip

MODEL	OVERALL LENGTH	BLADE LENGTH	CODE NUMBER	SUGGESTED RETAIL
123BL	8-1/2	3-3/4	320123BL	33.00



STONE COLD

TYPE Folding spear point or tanto **BLADE** Hollow ground 440 stainless steel • Black oxide finish • Thumbstud **HANDLE** Robust liner lock construction • Textured and checkered black G-10 scales • Four-way adjustable tactical pocket clip **FEATURES** Hardened glass breaking point and flipper

MODEL	DESCRIPTION	OVERALL LENGTH	BLADE LENGTH	CODE NUMBER	SUGGESTED RETAIL
A	113BL Tanto	8-5/8	3-3/4	320113BL	39.00
B	114BL Spear Point	8-5/8	3-3/4	320114BL	39.00

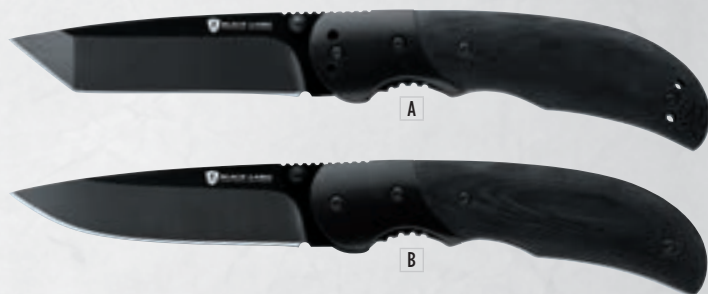

SUBMISSION

TYPE Folding tanto or spear point **BLADE** Hollow ground 440C stainless steel • Laser etched finish • Thumbstud **HANDLE** Robust liner lock construction • G-10 scales • Tactical pocket clip

MODEL	DESCRIPTION	OVERALL LENGTH	BLADE LENGTH	CODE NUMBER	SUGGESTED RETAIL
A	119BL Tanto	7-1/8	3-1/8	320119BL	30.00
B	120BL Spear Point	7-1/8	3-1/8	320120BL	30.00

SIDE EFFECTS

TYPE Folding modified drop point **BLADE** Hollow ground 8Cr13MoV stainless steel **HANDLE** Robust liner lock construction • G-10 scales • Tip up/tip down adjustable tactical pocket clip

MODEL	DESCRIPTION	OVERALL LENGTH	BLADE LENGTH	CODE NUMBER	SUGGESTED RETAIL
A	162BL Olive Drab	7-1/2	3-1/8	320162BL	33.00
B	161BL Coyote Tan	7-1/2	3-1/8	320161BL	33.00



BATTLE BOWIE CARBON FIBER

TYPE Fixed bowie **BLADE** Hollow ground 5Cr stainless steel • Laser etched finish **HANDLE** Full-tang construction • Black carbon fiber scales **SHEATH** Blade-Tech™ molded polymer with Tek-Lok™ belt clip easily adjusts for carry angle and belt loop width **THIS COLLECTIBLE KNIFE IS A LIMITED EDITION OF 1000 UNITS**

MODEL	OVERALL LENGTH	BLADE LENGTH	CODE NUMBER	SUGGESTED RETAIL
159BL	12-1/2	8	320159BL	183.00

BATTLE BOWIE G-10

TYPE Fixed bowie **BLADE** Hollow ground 5Cr stainless steel **HANDLE** Full-tang construction • Black G-10 scales **SHEATH** Blade-Tech™ molded polymer with Tek-Lok™ belt clip easily adjusts for carry angle and belt loop width **THIS MODEL HAS MANY OF THE SAME GREAT FEATURES OF THE LIMITED EDITION KNIFE AT A MORE AFFORDABLE PRICE**

MODEL	OVERALL LENGTH	BLADE LENGTH	CODE NUMBER	SUGGESTED RETAIL
160BL	12-1/2	8	320160BL	98.00



STICK-IT THROWING KNIFE SET

TYPE Fixed double edged throwing daggers **BLADES** Hollow ground, satin-finished 3Cr stainless steel **HANDLES** Full-tang **SHEATH** Nylon

MODEL	OVERALL LENGTH	BLADE LENGTH	CODE NUMBER	SUGGESTED RETAIL
122BL	8-1/2	4	320122BL	49.00



FEAR FACTOR

TYPE Fixed hawkbill/talon karambit-style **BLADE** Hollow ground 440 stainless steel • Gray titanium coating **HANDLE** Full-tang construction with finger choils • Textured black G-10 scales **SHEATH** Blade-Tech™ molded polymer with Tek-Lok™ belt clip easily adjusts for carry angle and belt loop width

MODEL	OVERALL LENGTH	BLADE LENGTH	CODE NUMBER	SUGGESTED RETAIL
141BL	7-5/8	3-1/2	320141BL	67.00

STRIKE FORCE

TYPE Fixed karambit-style **BLADE** Hollow ground 440 stainless steel • Gray titanium coating **HANDLE** Full-tang construction with finger loop • Textured black G-10 scales **SHEATH** Blade-Tech™ molded polymer with Tek-Lok™ belt clip easily adjusts for carry angle and belt loop width

MODEL	OVERALL LENGTH	BLADE LENGTH	CODE NUMBER	SUGGESTED RETAIL
142BL	8-3/8	4	320142BL	67.00



TRACER NECK DAGGER

TYPE Fixed double edged neck dagger **BLADE** Satin-finished 440 stainless steel **HANDLE** Textured G-10 sheath Kydex® neck-type with matte black ball chain

MODEL	OVERALL LENGTH	BLADE LENGTH	CODE NUMBER	SUGGESTED RETAIL
121BL	5-1/2	2	320121BL	22.00



SELF-DEFENSE WATER BOTTLE AND KNIFE COMBOS

TYPE Self-defense water bottle • Rugged textured polymer water bottle with molded finger grooves and ribbed back panel for improved grip • Embroidered nylon strap provides easy carry and aids retention • Cap and base are reinforced pink or gray polymer with strike points • Strap graphic matches cap and base color **KNIFE** Drop point stainless steel blade with liner lock • G-10 scales

MODEL	DESCRIPTION	CODE NUMBER	SUGGESTED RETAIL
A	147BL Black/Gray	320147BL	33.00
B	151BL Black/Pink	320151BL	33.00



IT'S NOT JUST A TACTICAL LIGHT. IT'S A TACTICAL LIGHTING SYSTEM.

Browning Black Label tactical lights are designed from the ground up to work as a modular system. Start with the basic light and add components as needed for expanded tactical lighting capabilities.



BLACK LABEL
TACTICAL LIGHTS



TACTICAL TAILCAP SWITCHES

- Multi-mode push-button tailcap switches allow partial depression for a quick search and full depression click to provide continuous lighting for threat identification and target engagement.
- Textured rubber-covered switch prevents finger slippage during activation.
- Rotating tailcap lock-out prevents accidental activation and a quick twist enables the light.



REMOTE CABLE SWITCH ENDCAP ACCESSORY

- Many Black Label lights (and many more of our flashlights) accept a remote cable switch endcap accessory that allows the user to activate the light while it is mounted on a long gun.
- The remote switchpad itself may be located on the pistol grip or forearm of a long gun with the included mounting hardware.



INTERCHANGEABLE METAL FRONT BEZEL RINGS

- Select from a smooth bezel for snag-free weapon-mounted applications or a crenelated strike bezel for handheld self-defense applications.

MULTIPLE MODE CAPABILITY

- Most Black Label lights offer a choice of continuous full output, continuous low-output and a rapid strobe mode.
- Simply toggle through the modes by quickly pressing the tailcap switch.

RAPID STROBE MODE

- Most Black Label lights offer a rapid strobe mode.
- The rapid strobe mode is ideal for rescue signalling or to disorient an attacker.



MIL-STD 1913 RAIL MOUNT

- Allows many Black Label lights (and many other Browning flashlights) to be attached to any MIL-STD 1913 Picatinny accessory rail.
- Included screwdriver allows simple installation of the light onto the mount.
- Thumbscrew allows easy installation and removal of the light to the rail without tools.



INTERCHANGEABLE REAR GLASS-BREAKER POINT

- Many Black Label lights are equipped with a hardened metal point on the rear bezel to allow the user to break window glass for emergency egress from a vehicle or from any glass-enclosed environment.



REMOVABLE ANTI-ROLL METAL FINGER RING

- Several Black Label flashlights are equipped with a metal anti-roll finger ring to prevent the light from rolling on a sloped surface, and allows the operator to use the "syringe" technique with a defensive handgun.



FL-1 1-METER WATERPROOF CERTIFICATION

- Most Black Label lights are certified to meet the latest international FL-1 Standard to operate after being submerged in 1 meter of water for 30 minutes.

NEW LED
15% BRIGHTER



TACTICAL 9V FLASHLIGHT

LENGTH 8-1/2" **BRIGHTNESS** 825 lumens **EFFECTIVE DISTANCE** 575 yards **FEATURES** Powerful Cree® XM-L white LED never needs replacing • Tactical lock-out tailcap switch • Momentary, continuous and fast strobe modes • Removable anti-roll finger retention ring • Non-slip all-aluminum body construction • Interchangeable smooth and crenelated front bezels • Interchangeable hardened glass breaking point mounted on robust aluminum alloy tailcap • Optically clear scratch-resistant glass lens • Waterproof • Submersible to three feet for 30 minutes • Drop tested to 1 meter • Incredible 60 hour run time on low output • Uses three CR123A batteries (included) • Mounts on rifles and shotguns with optional 1913 Picatinny rail mount and remote cable switch (sold separately)

CODE NUMBER	SUGGESTED RETAIL	BATTERIES	BATTERY LIFE	EFFECTIVE DISTANCE	LUMENS
3713205	159.00	(3) CR123A Lithium	High: 2 hours; Low: 60 hours	575	High: 825 Low: 20

TACTICAL 6V FLASHLIGHT

LENGTH 5-3/4" **BRIGHTNESS** 650 lumens **EFFECTIVE DISTANCE** 295 yards **FEATURES** Powerful Cree® XM-L white LED never needs replacing • Tactical lock-out tailcap switch • Momentary, continuous and fast strobe modes • Removable anti-roll finger retention ring • Non-slip all-aluminum body construction • Interchangeable smooth and crenelated front bezels • Interchangeable hardened glass breaking point mounted on robust aluminum alloy tailcap • Optically clear scratch-resistant glass lens • Waterproof • Submersible to three feet for 30 minutes • Drop tested to 1 meter • Incredible 60 hour run time on low output • Uses two CR123A batteries (included) • Mounts on rifles and shotguns with optional 1913 Picatinny rail mount and remote cable switch (sold separately)

CODE NUMBER	SUGGESTED RETAIL	BATTERIES	BATTERY LIFE	EFFECTIVE DISTANCE	LUMENS
3713204	122.00	(2) CR123A Lithium	High: 2 hours; Low: 60 hours	295	High: 650 Low: 20

NEW LED
10% BRIGHTER



TACTICAL 3V FLASHLIGHT

LENGTH 4-1/2" **BRIGHTNESS** 260 lumens **EFFECTIVE DISTANCE** 165 yards **FEATURES** Powerful white LED never needs replacing • Tactical lock-out tailcap switch • Momentary, continuous and fast strobe modes • Removable anti-roll finger retention ring • Non-slip all-aluminum body construction • Interchangeable smooth and crenelated front bezels • Interchangeable hardened glass breaking point mounted on robust aluminum alloy tailcap • Optically clear scratch-resistant glass lens • Waterproof • Submersible to three feet for 30 minutes • Drop tested to 1 meter • Incredible 24 hour run time on low output • Uses one CR123A battery (included) • Mounts on rifles and shotguns with optional 1913 Picatinny rail mount and remote cable switch (sold separately)

CODE NUMBER	SUGGESTED RETAIL	BATTERIES	BATTERY LIFE	EFFECTIVE DISTANCE	LUMENS
3713203	79.00	(1) CR123A Lithium	High: 2 hours; Low: 24 hours	165	High: 260 Low: 10

NEW LED
25% BRIGHTER



TACTICAL 1AA FLASHLIGHT

LENGTH 4-1/4" **BRIGHTNESS** 120 lumens **EFFECTIVE DISTANCE** 90 yards **FEATURES** Powerful white LED never needs replacing • Tactical lock-out tailcap switch • Momentary, continuous and fast strobe modes • Removable anti-roll finger retention ring • Non-slip all-aluminum body construction • Interchangeable smooth and crenelated front bezels • Interchangeable hardened glass breaking point mounted on robust aluminum alloy tailcap • Optically clear scratch-resistant glass lens • Waterproof • Submersible to three feet for 30 minutes • Drop tested to 1 meter • Incredible 20 hour run time on low output • Uses one AA battery (included) • Mounts on rifles and shotguns with optional 1913 Picatinny rail mount and remote cable switch (sold separately)

CODE NUMBER	SUGGESTED RETAIL	BATTERIES	BATTERY LIFE	EFFECTIVE DISTANCE	LUMENS
3713202	61.00	(1) AA Alkaline	High: 1.5 hours; Low: 20 hours	90	High: 120 Low: 14



PICATINNY RAIL MOUNT

FEATURES Rugged matte black all-aluminum construction • Allows easy mounting of Black Label AA, 3V and 6V or 9V flashlights on rifles and shotguns with MIL-STD 1913 Picatinny rails • Also fits many of our sporting flashlights including Alpha, Alpha Max, Crossfire, Catalyst and most flashlights with AA and CR123A batteries • Molded rubber ring improves fit and acts as a recoil vibration damper • Built-in rail key prevents slipping once mounted on the rail • Thumbscrew adjustable mount • Installation screwdriver is included

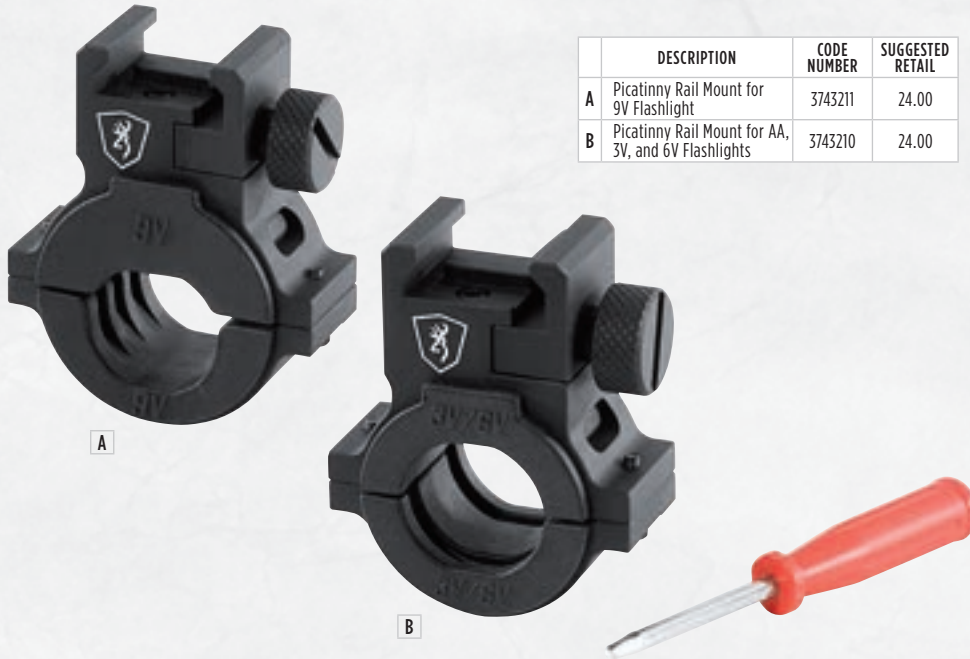

	DESCRIPTION	CODE NUMBER	SUGGESTED RETAIL
A	Picatinny Rail Mount for 9V Flashlight	3743211	24.00
B	Picatinny Rail Mount for AA, 3V, and 6V Flashlights	3743210	24.00

REMOTE CABLE SWITCH

FEATURES Rugged construction • Replaces factory tailcap switch to allow remote activation of Black Label AA or CR123A flashlights mounted on rifles and shotguns • Also fits many of our sporting flashlights including Alpha, Alpha Max, Chaos (AA model) and Catalyst (CR123 model) • Easily attached with two adjustable straps to pistol grip or forearm • Large momentary switch pad is easy to access, even with gloves • Push to activate light, release to turn off



	DESCRIPTION	CODE NUMBER	SUGGESTED RETAIL
A	Remote Cable Switch for AA Flashlight	3743212	24.00
B	Remote Cable Switch for 3V, 6V, 9V Flashlights	3743213	24.00



Allows the user to activate the light while it is mounted on a long gun. The remote switch pad itself may be located on the pistol grip or forearm.

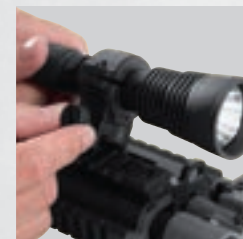

Allows many flashlights to be attached to any MIL-STD 1913 Picatinny accessory rail. Once the light is installed in the mount with the included screwdriver, the thumbscrew allows easy installation and removal without tools.

DISRUPTER COVERS THE QUARTER MILE AT THE SPEED OF LIGHT.

We offer some of the most powerful portable lighting tools available anywhere. Our new Distrupter is no bigger than a soda can, yet it can pump out a stunning 2800 lumens of white light that reaches out 500 yards (yes, that’s more than a quarter mile). Its rugged all-aluminum construction houses a 10400 mAh lithium-ion battery that can be recharged again and again from any home wall outlet or vehicle power outlet. See what’s across the valley or way down the river with the Distrupter.

DISRUPTER

LENGTH 7" **BRIGHTNESS** 50 to 2800 lumens **EFFECTIVE DISTANCE** 75 to 500 yards **FEATURES** Three super-bright white Cree® LEDs • Three red LEDs and three green LEDs for stealth, safety and night use • Rotary sleeve on switch protects against accidental light activation in pack or pocket • Thumb switch for momentary or continuous lighting • Select from high, medium or low output on white LEDs, plus green, red and fast strobe modes • All-aluminum body construction with optically clear scratch-resistant glass lens is built for years of rugged duty • Anti-roll bezel profile • Heat dissipating fins on lamphead • 10400 mAh rechargeable lithium-ion battery is rated at 500 charge cycles • Comes complete with household (AC) and vehicle (DC) chargers and all cords, including USB • Waterproof and submersible to three feet for 30 minutes • Drop tested to 1 meter • Rugged polymer carrying and storage case



MULTI-LED REFLECTOR

- Three super-bright white LEDs for maximum illumination out to 500 yards (that's more than 1/4 mile).
- Three green LEDs and three red LEDs for stealth, safety and night use.



FL-1 1-METER WATERPROOF CERTIFICATION

- Meets the latest international FL-1 Standard to operate after being submerged in 1 meter of water for 30 minutes.

NEW
DISRUPTER



CODE NUMBER	SUGGESTED RETAIL	BATTERIES	BATTERY LIFE
3714100	425.00	10400 mAh Lithium Ion Rechargeable	High: 1.4 hours Low: 48 hours

EDC PISTOL FLASHLIGHT

LENGTH 3-1/2" **BRIGHTNESS** 205 lumens **EFFECTIVE DISTANCE** 125 yards **FEATURES** Powerful white LED never needs replacing • Designed for pocket carry and firearm mounting • Tactical tailcap switches are fully ambidextrous • Momentary, continuous and fast strobe modes • Non-slip polymer body • Interchangeable smooth and crenelated metal front bezel rings • Lockout function via rotating front bezel • Optically clear scratch-resistant glass lens • Deep Carry Pocket Clip™ • Drop tested to 1 meter • Incredible 24 hour run time on low output • Uses one CR123A battery (included) • Mounts instantly on pistols, rifles and shotguns in multiple positions using the included mounting bracket • Bracket mounts on all 1913 Picatinny rails • Two rail bolts included

CODE NUMBER	SUGGESTED RETAIL	BATTERIES	BATTERY LIFE	EFFECTIVE DISTANCE	LUMENS
3713206	86.00	(1) CR123A Lithium	High: 2 hours; Low: 24 hours	125	High: 205 Low: 10



The Deep Carry Pocket Clip™ allows secure carry of the EDC Light Module.



EDC Light Module shown in firearm-mounted configuration.



Two ambidextrous side tailcap switches are easy to access with either hand for momentary lighting. A single under-switch enables continuous lighting in high, low and strobe modes.

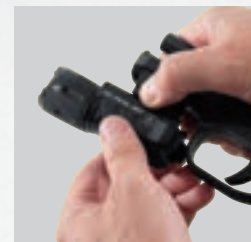

The rail bracket remains on the MIL-STD 1913 Picatinny rail of the firearm. The EDC Light Module instantly mounts to the rail.

APPROACH TACTICAL KEYCHAIN LIGHT
APPROACH TACTICAL KEYCHAIN LIGHT/KNIFE COMBO

LIGHT length 2-1/4" **BRIGHTNESS** 18 lumens effective distance 22 yards with white LEDs • 50 yards with red laser **FEATURES** Powerful keychain light quickly unbuckles from key ring and attaches to a pistol or other firearm • Two white LEDs plus one 5mW red laser for intimidation • Mounts on any MIL-STD 1913 Picatinny rail • Dual push-button switches on underside • LEDs and laser can be turned on separately or at the same time • 4 hour run time on LEDs • Rugged polymer construction with molded rail grabbers and rail key • Uses two 2016 coin-type batteries (included) • Laser is a directional pointer only and is not intended for use as a targeting indicator or firearm aiming device **KNIFE** Designed by Russ Kommer • Liner lock construction • 1-3/8" 5Cr stainless steel bead blasted blade • Checkered glass filled polymer handles • Knife quickly detaches from keychain

	DESCRIPTION	CODE NUMBER	SUGGESTED RETAIL	BATTERIES	BATTERY LIFE	EFFECTIVE DISTANCE	LUMENS
A	Approach	3713208	24.00	(2) 2016 Coin-Type	4 hours on LEDs	LED 22 Laser 50	18 on LEDs
B	Approach Tactical Combo	3713209	31.00	(2) 2016 Coin-Type	4 hours on LEDs	LED 22 Laser 50	18 on LEDs

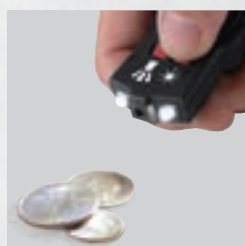
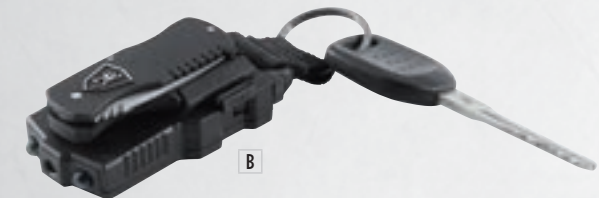
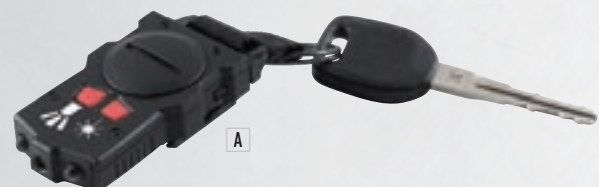

The Approach Tactical Keychain Light is normally carried in the pocket or purse for everyday task lighting chores.

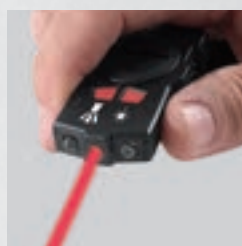

The laser pointer feature on the Approach Tactical Keychain Light can be used for teaching, business presentations or for emergency signalling.



The Approach Tactical Keychain Light can be instantly separated from the keychain and attached without tools to any MIL-STD 1913 Picatinny accessory rail.



The Approach Tactical Keychain Light/Knife Combo includes a small Russ Kommer-designed folding knife that rides on the rail slot.



The Russ Kommer-designed folding knife has a lockback closure and is intended to be removed from the light when used for cutting chores.



TACTICAL CAP LIGHT/KNIFE COMBO

BRIGHTNESS 19 lumens **EFFECTIVE DISTANCE** 22 yards **FEATURES** Two white LEDs and two red LEDs • 10 hour run time on white • 48 hour run time on red • Tilting design attaches to cap brim, pocket or pack strap • Uses two 2032 batteries (included) **RUSS KOMMER DESIGNED KNIFE** Frame lock design • 2-1/2" 440 stainless steel blade • Tanto point with partially serrated edge • Textured handle scales

CODE NUMBER	SUGGESTED RETAIL	BATTERIES	BATTERY LIFE	EFFECTIVE DISTANCE	LUMENS
3713201	24.00	(2) 2032 Button	White: 10 hours; Red: 48 hours	22	High: 19

**NEW LED
15% BRIGHTER**



TACTICAL 6V HEADLAMP

BRIGHTNESS 635 lumens **EFFECTIVE DISTANCE** 165 yards **FEATURES** Powerful Cree® XM-L white LED never needs replacing • Four brightness settings plus strobe mode • Silent Tilt Hinge for added stealth • Soft rubber head plate for added comfort • Ultra tough anodized all-aluminum body construction • Waterproof • Submersible to three feet for 30 minutes • Drop tested to 1 meter • Incredible 48 hour run time on low output • Uses two CR123A batteries (included)

CODE NUMBER	SUGGESTED RETAIL	BATTERIES	BATTERY LIFE	EFFECTIVE DISTANCE	LUMENS
3713340	110.00	(2) CR123A Lithium	High: 3 hours; Low: 48 hours	165	High: 635; Low: 30



TACTICAL AA HEADLAMP

BRIGHTNESS 125 lumens **EFFECTIVE DISTANCE** 75 yards **FEATURES** Powerful white LED never needs replacing • Lock out battery cap • Two brightness settings plus strobe mode • Silent Tilt Hinge for added stealth • Soft rubber head plate for added comfort • Ultra tough anodized all-aluminum body construction • Optically clear scratch-resistant glass lens • Waterproof • Submersible to three feet for 30 minutes • Drop tested to 1 meter • Incredible 20 hour run time on low output • Uses one AA battery (included)

CODE NUMBER	SUGGESTED RETAIL	BATTERIES	BATTERY LIFE	EFFECTIVE DISTANCE	LUMENS
3713230	61.00	(1) AA Alkaline	High: 1.5 hours; Low: 20 hours	75	High: 125; Low: 10



ALFA RANGE BAG

Heavy-duty padded ballistic polyester fabric shell with water-resistant urethane interior coating • Polymer bottom scuff pads • Self-healing nylon coil zippers with paracord pull tabs • Heavy web handles • Two zippered end compartments • Roomy main compartment with four organizer pockets • Two zippered side compartments with six elastic magazine retainers and internal organizer pockets • Removable ammo/accessory bag with zippered top and hook and loop side pockets • Embroidered Black Label logo • 15" W x 9" H x 11" D • Firearm and accessories shown not included

CODE NUMBER	SUGGESTED RETAIL
121501991	115.00

**ALFA DOUBLE PISTOL CASE**

Heavy-duty padded ballistic polyester fabric shell with water-resistant urethane interior coating • Two form-fitted internal zippered pistol pockets • Six elastic magazine slots • Fully-bound internal seams • Self-healing nylon coil zippers with corded pull tabs • Heavy web handles • MOLLE compatible • Accessory pouch • Embroidered Black Label logos • 12" W x 10" H x 2-1/2" D • Firearms and accessories shown not included

CODE NUMBER	SUGGESTED RETAIL
143501912	54.00

ALFA PISTOL CASE

Heavy-duty ballistic polyester fabric shell • Military-grade closed cell foam padding • Self-healing nylon coil main zipper with paracord pull tabs and lockable eyelets • Heavy sewn web handles • Six elastic magazine retainers and an internal zippered pocket for sidearms with up to 7" barrel • Embroidered Black Label logo • 11" W x 9" H x 2-1/2" D • Firearm and accessories shown not included

CODE NUMBER	SUGGESTED RETAIL
143501911	38.00

**ALFA SHOULDER BAG**

Heavy-duty ballistic polyester fabric shell • Heavy-duty self-healing nylon coil zippers with paracord pull tabs • Lay-flat design allows full access to main compartment contents • Fully-bound internal seam edging • Top grab loop and padded shoulder strap • MOLLE compatible nylon webbing on sides and rear • Three zippered compartments with multiple internal zippered organizer pockets • Hidden rapid-access sidearm pocket with hook and loop lining and closure • Removable accessory pouch • Embroidered Black Label logo • Black • 10" W x 13" H x 8" D • Firearm and accessories shown not included

CODE NUMBER	SUGGESTED RETAIL
121501995	115.00



ALFA DOUBLE AR CASE

Heavy-duty padded ballistic polyester fabric shell with water-resistant urethane interior coating • Padded internal corner buffers help protect guns and optics • Internal hook and loop tie-down webbing holds two AR/modern sporting rifles • Fully-bound internal seams • Self-healing nylon coil zippers with corded pull tabs • Heavy web handles • Hidden pistol compartment • Padded shoulder straps in hidden zippered compartment • MOLLE compatible • Large exterior accessory pouch • Two removable zippered accessory pouches • External lashing straps • Embroidered Black Label logos • 37" W x 11" H x 3" D • Firearms and accessories shown not included

CODE NUMBER	SUGGESTED RETAIL
143501914	188.00

ALFA LONG GUN CASE

Heavy-duty ballistic polyester fabric shell • Large enough for a 40" scoped firearm • Exterior zippered accessory pocket • Full-length nylon main zipper allows open case to lay flat • D-rings and zipper eyelets accommodate locking device (lock not included) • Oxford polyester lining • Removable hook and loop tie-down straps help secure firearm • Heavy-duty closed cell padding • Interior document security pocket • Embroidered Black Label logo

CODE NUMBER	SUGGESTED RETAIL
1415019240	60.00



ALFA TACTICAL GEAR BAG

The ultimate mid-size tactical gear and range bag • Use as a backpack or as a duffel • Heavy-duty ballistic polyester fabric shell with water-resistant urethane interior coating • Self-healing nylon coil zippers with paracord pull tabs • Multiple heavy web handles and haul loops • Large zippered top load compartment • Hidden full-length hydration bladder compartment • Mesh document organizer pockets • Top end headphone/microphone port with hook and loop closure • Hidden pistol compartment • Two elastic mesh side pockets • Bottom zippered compartment with three metal drain grommets for wet gear • Padded shoulder straps and back panel • Adjustable web waist belt with QD buckle • MOLLE compatible • Embroidered Black Label logos • 15" W x 24" H x 9" D • Internal volume approximately 2135 cubic inches • Firearm and accessories shown not included

CODE NUMBER	SUGGESTED RETAIL
121501996	155.00



The Alfa Tactical Gear Bag's hidden pistol pocket allows discrete transportation and storage (plus instant access) to a lawfully-carried concealed handgun.



The Alfa Tactical Gear Bag instantly converts from a well-balanced hand duffel to a rugged double strap backpack for longer treks across the range with heavier loads.



The Alfa Tactical Gear Bag provides loads of room for guns, ammo and accessories. The wide opening offers quick and easy access to everything inside.

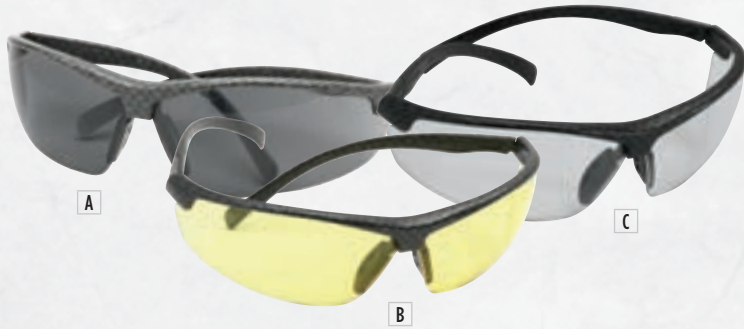

ARBITRATOR TACTICAL GLASSES

Lightweight, low-profile tactical glasses • 9.5 base curve polycarbonate lens for enhanced side protection • Meets ANSI Z87.1-2003 impact standards • 99% UV protection • Soft PVC nosepiece prevents slipping • Polycarbonate frame for strength and durability • Black/gray frame with carbon fiber pattern in choice of yellow, smoke or clear lens

DESCRIPTION	CODE NUMBER	SUGGESTED RETAIL
A Smoke	12768	26.00
B Yellow	12769	26.00
C Clear	12770	26.00

LANDING ZONE TACTICAL GLASSES

Lightweight, low-profile tactical glasses • Zeiss® interchangeable 8 base curve single polycarbonate lens for superior clarity and enhanced side protection • Meets ANSI Z87.1-2003 impact standards • Soft TPR nosepiece for all day comfort • Polycarbonate frame and dual injected earpieces with soft rubber tips for non-slip fit • Black/gray carbon fiber pattern frame with smoke, clear and yellow lens sets included • Includes case (not shown)



CODE NUMBER	SUGGESTED RETAIL
12771	106.00



PERFECT STORM TACTICAL GOGGLES

Lightweight, low-profile tactical goggles • Interchangeable temples or elastic strap to keep goggles in place during aggressive physical activity • Polycarbonate outer lens meets ANSI Z87.1-2003 impact standards • 99% UV protection • Acetate inner lens with H2X coating prevents fogging • Vented foam frame helps prevent moisture build-up • Black/gray frame with carbon fiber pattern • Includes smoke, clear and yellow lenses • Includes zipper case

CODE NUMBER	SUGGESTED RETAIL
12774	138.00



TACTICAL RANGE KIT II

Shooting glasses with tinted polycarbonate lenses provide both outstanding eye protection plus enhanced target visibility under various lighting conditions • Soft foam earplugs provide noise reduction up to 31 dB and come with a plastic storage case

- Adjustable-fit earmuffs with padded headband have a noise reduction rating of 26 dB
- Meets ANSI S3.19 noise reduction standards • Black/gray frame with carbon fiber finish

CODE NUMBER	SUGGESTED RETAIL
126374	66.00

EVADER II

Adjustable-fit earmuffs with padded headband for added comfort • Meets ANSI S3.19 noise reduction standards

- NRR 26 dB • Black/gray frame with carbon fiber finish

CODE NUMBER	SUGGESTED RETAIL
12689	53.00



ROGUE NEW

100% cotton rip stop fabric • No top button to eliminate pressure point when wearing earmuffs • Loop fabric patches front and back to attach morale patches • U.S. Flag emblem on side • Hook and loop back closure

DESCRIPTION	CODE NUMBER	SUGGESTED RETAIL	SIZE
(SHOWN IN OLIVE DRAB)			
Black	308558991	20.00	One Size Fits Most
Sand	308558481	20.00	One Size Fits Most
Olive Drab	308558841	20.00	One Size Fits Most
Desert Brown	308558681	20.00	One Size Fits Most



SHIELD MESH BACK

Tactile spandex front panel and crown with eyelets • Black synthetic mesh back for added ventilation in warmer weather • Button top • Snap back closure • Sew-on synthetic rubber Black Label Tactical graphics

CODE NUMBER	SUGGESTED RETAIL	SIZE
308556991	21.00	One Size Fits Most



CHECK POINT

100% polyester waffle-weave fabric • Hook and loop back closure • Black Label Tactical graphics embroidery front and back

CODE NUMBER	SUGGESTED RETAIL	SIZE
308557991	20.00	One Size Fits Most



DUTY

Gray/green military digital camo • 100% cotton ripstop fabric • Hook and loop back closure • Loop fabric patch on crown for infrared ID tape • Black Label Tactical graphics embroidery front and back • U.S. flag embroidery on side

CODE NUMBER	SUGGESTED RETAIL	SIZE
308555291	18.00	One Size Fits Most



BRAVO FLEXFIT TWILL

Gray heather twill fabric panels with eyelets • Button top • Classic Flexfit band

CODE NUMBER	SUGGESTED RETAIL	SIZE
308551892	25.00	S/M
308551894	25.00	L/XL



ALFA FLEXFIT MESH BACK

Gray twill fabric front panel with eyelets • Black synthetic mesh back for added ventilation in warmer weather • Button top • Classic Flexfit band

CODE NUMBER	SUGGESTED RETAIL	SIZE
308550892	25.00	S/M
308550894	25.00	L/XL



DELTA TACTICAL PATROL CAP

Black ripstop fabric panels with eyelets • Button top • Hook and loop tab adjustment band • 3D embroidery of Black Label Tactical graphics

CODE NUMBER	SUGGESTED RETAIL	SIZE
308553991	18.00	One Size Fits Most



ECHO TACTICAL BEANIE

Stretch knit exterior • Soft polyester fleece lining and edging • Four-point tailoring for a roomy, comfortable fit • Black Label Tactical graphic imprint • Ideal for cold weather training and night operations in the field

CODE NUMBER	SUGGESTED RETAIL	SIZE
308554991	17.00	One Size Fits Most

BLACK LABEL TACTICAL CLOTHING.

Browning Black Label tactical clothing is built to take on any mission in any environment. Durable fabrics, robust construction and sharp styling bring comfort and protection to the operator. Black Label is the brand to be in when it's time to dress for mission success.



BLACK LABEL
TACTICAL CLOTHING

**CONCEALACCESS ENTRY**

- ConcealAccess side seams are secured with zippers or hook and loop fasteners, yet open instantly for access to a lawfully concealed sidearm.

**REACTAR POCKETS**

- Pockets inside the shoulders accept a REACTAR G2 pad that absorbs recoil from hard-kicking rifles and shotguns. REACTAR G2 pad is sold separately.

**SNAPSHOT ACCESS**

- SnapShot magnetic buttons allow instant access to a lawfully concealed sidearm carried under the shirt in a shoulder holster.

**CONCEAL POCKETS**

- Concealed pocket lets the wearer stow a cell phone, carry permit or credentials, tactical lights and other items, yet have them right at their fingertips.

**EYEWEAR/MIC/RADIO LOOP**

- Front placket loop keeps eyewear, a small radio or a microphone handy for instant access with either hand from any position.

**PEN POCKETS**

- Pen pockets on the sleeve keeps pens, pen lights or other similar items within easy reach.

**ON-SLEEVE ZIP POCKET**

- Keep small items close at hand in the on-sleeve zippered pocket. This feature is especially handy when seated in a vehicle or when working undercover.

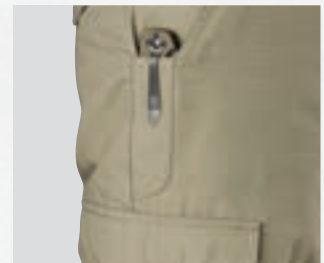
**KNIFE CLIP OVERLAY**

- Overlay on front pockets is extended downward to protect the pant from wear or abrasion caused by the pocket clips on knives, flashlights and pocket tools.

**HEAVY DUTY BELT LOOPS**

- Heavy duty belt loops enable the wearer to carry a lawfully concealed sidearm, extra ammo and other gear with security and confidence.

**KNEEPAD POCKETS**

- Internal kneepad pockets allow use of various pads, while the pad loading opening is sized to make insertion a snap. (Kneepads are not included.)

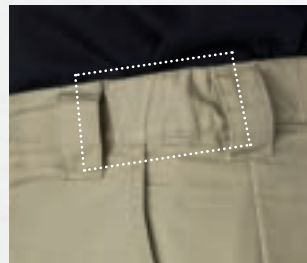
**STRETCH WAISTBAND**

- Stretch waistband moves freely without binding or pinching, especially when wearing a lawfully concealed sidearm.

**ACCESSORY POCKET**

- Flapped accessory pocket puts a phone, PDA, digital camera or spare magazine right at the wearer's fingertips.

TACTICAL SHIRTS

Lightweight cotton/spandex fabric • Seven-button front placket • SnapShot hidden magnetic center buttons for fast access to shoulder holster or security credentials • Internal REACTAR G2 pad pockets (pad not included) • Vented back • Hidden collar stays • Two front-load pockets • Two pleated chest pockets • Elbow overlays on long sleeve models

DESCRIPTION	CODE NUMBER	SUGGESTED RETAIL	SIZE
SHORT SLEEVE (SHOWN IN SAND)			
Black	30138499	53.00	S-XL
		60.00	2XL-3XL
Sand	30138448	53.00	S-XL
		60.00	2XL-3XL
Forest	30138494	53.00	S-XL
		60.00	2XL-3XL
Desert Brown	30138468	53.00	S-XL
		60.00	2XL-3XL
LONG SLEEVE (SHOWN IN FOREST)			
Black	30138599	67.00	S-XL
		72.00	2XL-3XL
Sand	30138548	67.00	S-XL
		72.00	2XL-3XL
Forest	30138594	67.00	S-XL
		72.00	2XL-3XL
Desert Brown	30138568	67.00	S-XL
		72.00	2XL-3XL

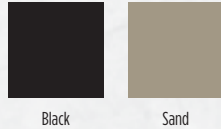

PERFORMANCE POLO SHIRT

Wrinkle-resistant polyester knit fabric with moisture wicking properties • Sewn self-fabric collar • Vented back • Internal REACTAR G2 pad pockets (pad not included) • ConcealAccess split sides with hook and loop closure • Lower placket microphone clip loop • Pen pockets on left sleeve • Welded patch pocket on right sleeve

DESCRIPTION	CODE NUMBER	SUGGESTED RETAIL	SIZE
(SHOWN IN FOREST)			
Black	30138299	53.00	S-XL
		60.00	2XL-3XL
Sand	30138248	53.00	S-XL
		60.00	2XL-3XL
Forest	30138294	53.00	S-XL
		60.00	2XL-3XL



TACTICAL PRO PANT

Lightweight poly/cotton ripstop fabric • Partial elasticized waistband • Heavy-duty belt loops • Gusseted crotch • Internal knee pad pockets (pads not included) • Two accessory side pockets • Two rear pockets • Pocket flaps for added security • Knife clip overlay on front pockets • Internal cuff guard **WAIST SIZES** 32", 34", 36", 38", 40", 42", 44" **INSEAM LENGTHS** 32", 34"

DESCRIPTION	CODE NUMBER	SUGGESTED RETAIL	SIZE
(SHOWN IN DESERT BROWN)			
Black	30238199	80.00	32, 34, 36, 38
		87.00	40, 42, 44
Sand	30238148	80.00	32, 34, 36, 38
		87.00	40, 42, 44
Forest	30238194	80.00	32, 34, 36, 38
		87.00	40, 42, 44
Desert Brown	30238168	80.00	32, 34, 36, 38
		87.00	40, 42, 44



TEAM T-SHIRT

100% polyester knit fabric with moisture wicking properties
 • Lightweight breathable material keeps wearer comfortable in hot and humid weather • Sublimated printed design

DESCRIPTION	CODE NUMBER	SUGGESTED RETAIL	SIZE
Gray/Black	30138899	106.00	S-XL
		113.00	2XL-3XL



Gray Black



PERFORMANCE T-SHIRTS

Polyester knit fabric with moisture wicking properties • Comfortable crew neck • Ideal for wear with duty uniform, body armor or web gear

DESCRIPTION	CODE NUMBER	SUGGESTED RETAIL	SIZE
SHORT SLEEVE			
Black	30138099	40.00	S-XL
		46.00	2XL-3XL
LONG SLEEVE			
Black	30138199	53.00	S-XL
		60.00	2XL-3XL



Black

TACTICAL PERFORMANCE HOODIE

100% polyester knit fabric • Smooth outer surface with contrasting color panels • Soft fleece interior surface
 • Self cuffs • ConcealAccess split sides • Roomy drawcord hood

DESCRIPTION	CODE NUMBER	SUGGESTED RETAIL	SIZE
Black/Gray	30138999	73.00	S-XL
		80.00	2XL-3XL



Black Gray



FIREPOWER FLEECE JACKET

Midweight polyester fleece • ConcealAccess split sides with non-locking zippers
 • Two side slash pockets • Internal REACTAR G2 pad pockets (pad not included)
 • Lined sleeves for easy on/off • Lycra® cuffs and sleeve pocket

DESCRIPTION	CODE NUMBER	SUGGESTED RETAIL	SIZE
Forest	30438394	185.00	S-XL
		200.00	2XL-3XL



Forest



TRACER SOFT SHELL JACKET

2-Layer soft shell fabric is highly breathable • One chest concealed carry pocket
 • ConcealAccess split sides with non-locking zippers • Two side slash pockets with hidden internal zippered pocket • Internal REACTAR G2 pad pockets (pad not included) • Lycra® cuffs and welded sleeve pocket with zipper

DESCRIPTION	CODE NUMBER	SUGGESTED RETAIL	SIZE
(SHOWN IN FOREST/DESERT)			
Black/Gray	30438299	200.00	S-XL
		213.00	2XL-3XL
Forest/Desert	30438294	200.00	S-XL
		213.00	2XL-3XL



Black Gray Forest Desert



FMJ WINDKILL JACKET

3-Layer WindKill fabric • Upper body faced in ripstop fabric • Two chest concealed carry pockets • ConcealAccess split sides with non-locking zippers
 • Armpit zippers • Two side slash pockets • Adjustable cuffs • Internal REACTAR G2 pad pockets (pad not included) • Welded sleeve pocket

DESCRIPTION	CODE NUMBER	SUGGESTED RETAIL	SIZE
(SHOWN IN BLACK/GRAY)			
Black/Gray	30438179	225.00	S-XL
		240.00	2XL-3XL
Forest/Desert	30438194	225.00	S-XL
		240.00	2XL-3XL



Black Gray Forest Desert



From world-class shooters to the hardest of the hardcore hunters to unique personalities, the members of the Browning ProStaff all share a love of the outdoors, the shooting sports and the greatest gun brand in the world. ProStaff members are chosen for their skill, professionalism and enthusiasm in promoting the Browning brand. Look for these faces at major shooting events and on television.

KASSIDEE DUNFORD

Kassidee is the latest member of the Browning ProStaff family. Although young, her energy and enthusiasm towards the shooting sports is contagious. Coming up through the Youth Hunter Education Challenge (YHEC) program, Kassidee won numerous shooting titles in all categories, but it's trap shooting that has captured her heart. A gold medal at the preliminary tryouts in December of 2012 and a solid fifth place at the USA Shooting spring selection match is a testament to her spirit and mileposts on her path to Olympic gold.

JOHNNY MEITZEN

Johnny started shooting competitively in 1987 and is currently a NSCA Level III instructor. He has won a number of shooting titles including two-time NSCA Nationals Vet Champion and two-time NSCA Nationals FITASC Vet Champion. Johnny is a six-time All-American Sporting Team member, two-time Team USA Sporting member and two-time Team USA FITASC member. He also has many state and zone championship titles to his credit. Johnny is a die-hard Citori man. His current model of choice is the Citori 625 Sporting.

ROBBIE PURSER

Robbie started shooting skeet at the tender age of six. Over the years he has accumulated an impressive list of shooting titles including 1980 World Skeet Champion, 1991 and 1998 NSCA Champion, Zone 4 Champion, Quail Unlimited Champion, four-time Ducks Unlimited Champion, 2002 Sportsman Team Challenge Champion and an ESPN Great Outdoor Games gold medalist. He is also a twelve-time All-American Team member, a member of Team USA and a ten-time Georgia State Champion. All told, Robbie has more than 200 tournament wins to his credit.

RICK CAMUGLIA

Rick is a long-time Browning shooter with multiple sporting clays titles, nearly all won with Browning autoloading shotguns. A short list of his victories includes multiple National and Regional FITASC Championships, nine-time New Mexico State Champion, two-time HOA Arizona State Champion and two-time HOA Colorado State Champion. He is also an eight-time NSCA All-American Team member. Rick prefers to shoot the Maxus autoloader.

FOSTER AND MATT BARTHOLOW

Foster and Matt are rising stars on the ATA trapshooting circuit, and both shoot Browning Citori shotguns. The brothers came up through the Scholastic Clay Target Program and have made their mark within the open ranks. Whether in a shoot-off with legendary Leo Harrison III or winning the Preliminary Doubles event at the Grand American, both will tell you that the Citori shotgun is a workhorse that just keeps on shooting, round after round, year after year.

KRISTY LEE COOK

Kristy brought her amazing voice to the TV screen on the 7th season of *American Idol*®. Now Kristy is a rising country music singer and possesses an infectious passion for everything she does, whether it is performing, hunting or saving horses through the Kristy Lee Horse Heaven Foundation.

ZAC COOPER

Zac took his first deer at the age of five and hunting has become his way of life. Zac joined the Browning ProStaff Team at age 13 and has spent the last 5 years traveling across America as a guest speaker at events such as the 2013 Iowa State Trap Shoot, the 2013 Kansas Hunter Education Instructor Academy, the 2012 and 2013 Monster Buck Classics in Kansas, the QDMA National Convention and the NWT National Convention. Now 17, Zac is on track to complete his two-year Business degree in early 2014 with full academic honors.

Through his speaking engagements and his DVDs "Little Man, Big Dreams" and "The Cooper Family Tradition," Zac is on his way to pursuing his two long term goals: To be a positive influence on today's youth and to help get them into the sport of hunting.

ALASKA OUTDOORS



Bush pilot and Alaskan big game hunter, Rob Stone began his story 40 years ago in the backcountry mountains of Alaska's last frontier. With a family tradition of flying and hunting came his passion for quality firearms. Gifted a Browning at age 16, Rob hunted every chance he was given. His 17-year old son Matthew now carries on the tradition in search of his own hunting adventures and so the passion continues.

As host of *Alaska Outdoors Television*, Rob shares his passion for the outdoors as a true supporter of conservation and ethical hunting. From hunting high for Alaska's Dall sheep to lowland swamps and tundra for Yukon moose and grizzlies, it's boots to the ground every season for Rob and his family.

AVIAN-X



Fred Zink founded Zink Calls™ in 2001 primarily to fulfill the needs of waterfowlers and professionals who demanded high-end calls. A nationally-recognized goose caller in his own right, Zink's business continues to grow and set new standards in the industry.

Zink's high-octane 24/7 DVD series is designed to speak to hunters with exciting footage that shares his hunting experiences with his viewers.

As host of the popular TV series, *Avian-X*, Fred embarks on hunts throughout the U.S. and Canada sharing the excitement and letting his viewers in on his highly successful calling tactics and strategies.

BOB REDFERN OUTDOORS



Bob Redfern's experience as an outdoor TV personality extends back more than 35 years. With his lifelong devotion to promoting hunting, shooting sports, fishing, and conservation efforts, Bob ventured out on his own in 2001 to begin the highly successful outdoor series, *Bob Redfern's Outdoor Magazine*.

Bob enjoys bringing the outdoors and the best it has to offer to the screen each week featuring real life hunting and fishing adventures with featured segments on *How to Succeed* at hunting, shooting, and fishing as well as the award-winning *Sportsman's Table* weekly cooking segment. Each week Bob features hunting and fishing destinations around the country for the sportsman who seeks the best places to enjoy the outdoors year round.

BOUNDLESS HUNTING



Boundless Hunting TV showcases the high adventures of William and McLean Russell, two brothers who grew up hunting the brush country with a passion for the land, nature, and its wildlife. They spent days as youth rattling up whitetails, flushing quail coveys, chasing predators, calling in turkey gobblers, and surprising wild hogs in the thickets.

Viewers will enjoy the excitement and wide range of animals pursued around the globe from bull elephant to brown bear. *Boundless Hunting TV* is fun and suspenseful with a deep immersion into the world of nature and the pursuit of wild game.

KNIGHT & HALE



With a product line that includes turkey, waterfowl, deer, predator, small and big game, every corner of North America boasts Knight & Hale calls. Likewise, numerous world calling championships have been taken with the calls designed by these two friends from Kentucky. Their television program *Knight & Hale's Ultimate Hunting* has been one of the most popular hunting programs on broadcast TV since 1986.

David has gained award-winning acclaim as a videographer throughout his career and remains active as a hunter, game manager and popular television personality.

Harold has won many national calling competitions, including the World Goose Calling Championship. Although retired from the calling circuit, he remains active as a judge and a lifetime member of the National Wild Turkey Federation.

PURE HUNTING

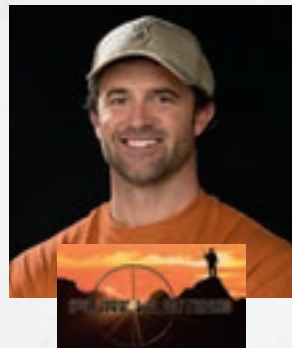

Shortly after leaving the corporate world, Willi Schmidt decided to pursue his passion for the outdoors as a host on outdoor TV, but never felt he was showcasing the way he loved to hunt...with the challenge of succeeding and failing on his own.

Now as the host of his own show *Pure Hunting*, he loves taking viewers on his Do-it-Yourself adventures and showing that pure hunting opportunities still exist for those willing to put in the effort. Willi appreciates the hunt for the journey, not just the result and he enjoys the friendships made and camaraderie experienced along the way.

UNCAGED



Matt is a nine-time UFC® World Welterweight Champion and was inducted into the UFC Hall of Fame in 2010. Matt spent a good portion of his early years hunting and shooting — passions that have never left him.

Matt's new television show *Uncaged* is an un-scripted reality show based on his hunting adventures, giving his fans an unprecedented look inside his life beyond the Octagon as a husband, father and hunter.

The half-hour show will follow Matt as he travels the world in pursuit of some of the world's most challenging big game species. *Uncaged* will bring the viewer along on his journey as he meets new people, explores new places and deals with the dangers and physical challenges of each adventure.



As much an emblem of the outdoor lifestyle as it is of the Browning brand, the Buckmark is the most recognizable symbol in the firearm industry. Whether on vehicles, T-shirts, caps, or permanently inked on the body, the Buckmark is a statement about your lifestyle. We have partnered with the companies on the following pages to represent the Browning brand with quality products and to share the Browning commitment to the outdoor industry.

AIRGUNS

High-performance designs like the 800 Series pistols, replica Buck Mark, and under-lever cocking Leverage Air Rifle are cornerstones of this versatile line-up of top-quality airguns.

UMAREX USA

7700 Chad Colley Blvd., Fort Smith, AR 72916

Phone: 479-646-4210

www.umarexusa.com/browning

BED AND BATH

Available Products: Sheet Sets • Comforter Sets • Drapes • Valances • Accent Pillows • Crib Bedding • Bath Towels • Bath Mats • Toothbrush Holders • Waste Baskets • Tumblers • Lotion Pumps • Shower Curtain Hooks • Soap Dishes • Tissue Box Covers • Night Lights • Throws • Wall Border • Area Rugs

KIMLOR INNOVATIVE HOME FASHIONS

2630 St. Matthews Rd., Orangeburg, SC 29118

Phone: 800-762-0007

www.kimlor.com

BELTS

Leather belts and suspenders are made of the finest materials and craftsmanship. Whether out in the field or everyday wear, you are covered with a full line of hunting and casual belts and suspenders that will provide comfort and style second to none.

UNIFIED INC.

35 W. 36th St., Suite 5E, New York, NY 10018

Phone: 646-370-4650

www.browningleatherbelts.com

CAMPING

Hunting camps require sturdy and weather-resistant tents, warm and comfortable sleeping bags, air pads that soften the ground and add warmth, furniture that is durable and comfortable and fully featured hunting blinds.

ALPS

4575 Hwy. 185, New Haven, MO 63068

Phone: 800-344-2577

www.browningcamping.com

CASUAL SPORTSWEAR

Lifestyle casual sportswear including work wear, performance and casual pieces that function with style and comfort while standing up to the rigors of everyday life. Casual collections feature classic styling with unique details and thoughtfully selected colors.

SIGNATURE PRODUCTS GROUP

1490 N. 2200 W., Salt Lake City, UT 84116

Phone: 800-553-1098

www.spgcompany.com

EYEWEAR AND ACCESSORIES

High quality polarized eyewear and a variety of accessories for the sportsman. Drink ware including soft coolers, coozies, insulated cups and stainless mugs are also available.

AES OPTICS, INC.

201 Corporate Ct., P.O. Box 828, Senatobia, MS 38668

Phone: 800-416-0866

www.browningeyewear.com

FISHING

Lightweight, precision geared casting reels, sensitive, high tensile strength carbon rods and durable machined aluminum pliers offer serious value and performance to every angler.

BASS PRO SHOPS

2500 E. Kearney, Springfield, MO 65898

Phone: 417-873-5274

www.browningfishing.com



GIFTS

Lifestyle-driven gift and stationery products that make fine gifts, plus a large selection of other unique products is available from games, to jewelry, to wrapping paper.

SIGNATURE PRODUCTS GROUP

1490 N. 2200 W., Salt Lake City, UT 84116

Phone: 800-553-1098

www.spgcompany.com

METAL PRODUCTS

Helping outdoorsmen enjoy juicy steaks or grilled trout fresh from the day's catch by cooking them on a grill or smoker. Food processing equipment including grinders, slicers and dehydrators are also available.

RANKAM GROUP

1618 W. Rosecrans Ave., Gardena, CA 90249

Phone: 248-330-8273

www.rankam.com

OUTDOOR COOKWEAR

Committed to providing a full selection of high quality cooking equipment for the true sportsman who is dedicated to cooking for hunters with an appetite.

CAMP CHEF

3985 N. 75 W., Hyde Park, UT 84318

Phone: 800-650-2433

www.campchef.com

SIGNATURE AUTOMOTIVE

Automotive accessories that showcase the iconic Buckmark, with a full line of quality interior and exterior products designed to provide protection and personalization and compliment the outdoor lifestyle.

SIGNATURE PRODUCTS GROUP

1490 N. 2200 W., Salt Lake City, UT 84116

Phone: 800-553-1098

www.spgcompany.com

SOCKS

Made in the USA equates to quality and immediate availability. Socks are produced using only premium materials and the latest fiber technologies and are ready for all season wear with warmth, comfort and durability for every member of the family.

CAROLINA HOSIERY

2316 Tucker St., Burlington, NC 27215

Phone: 336-226-5581

www.carolinahosiery.com

SPORTING BAGS AND TRAVEL GEAR

High quality packs and bags geared to meet all your carry needs. Whether you're out hunting, traveling, or just showing your Buckmark pride, our line will be what you're looking for. Durable materials, customer understanding, and product innovation provide the right tools for the right job.

SIGNATURE PRODUCTS GROUP

1490 N. 2200 W., Salt Lake City, UT 84116

Phone: 800-553-1098

www.spgcompany.com

TRAIL CAMERAS

A complete line of motion-sensing trail cameras capable of capturing still pictures, video clips or time-lapse imagery of game. Tree mounts, SD cards, security boxes and batteries are also available.

PROMETHEUS GROUP

Two Perimeter Park South, Suite 305 East, Birmingham, AL 35243

Phone: 888-618-4496

www.browningtrailcameras.com



**HARDEST
WORKING.
SMOOTHEST
RIDING.**

ALL NEW
Sportsman® 570 EFI



SPORTSMAN

**INCREDIBLE VALUE
AND PERFORMANCE**

Sportsman 570 EFI:
now with 44 hp, improved
comfort and EFI!



ALL-NEW
RANGER® CREW 900

RANGER

**CLASS-LEADING
POWER**

RANGER CREW 900:
60hp, tows a ton and
comfortably seats 5



ALL NEW
RANGER® 570 EFI

Vehicles shown with optional accessories.

RANGER

**MID-SIZE VALUE,
FULL-SIZE
PERFORMANCE**

RANGER 570 EFI:
Now with 40hp and optional
Electronic Power Steering

BUILD YOUR PERFECT HUNTING MACHINE AT POLARIS.COM



POLARIS®

Warning: The Polaris RANGER® and RZR® are not intended for on-road use. Driver must be at least 16 years old with a valid driver's license to operate. Passengers must be at least 12 years old and tall enough to grasp the hand holds and plant feet firmly on the floor. All S/S drivers should take a safety training course. Contact ROHVA at www.rohva.org or (949) 255-2560 for additional information. Drivers and passengers should always wear helmets, eye protection, protective clothing, and seat belts. Always use cab nets or doors (as equipped). Be particularly careful on difficult terrain. Never drive on public roads or paved surfaces. Never engage in stunt driving, and avoid excessive speeds and sharp turns. Riding and alcohol/drugs don't mix. Check local laws before riding on trails. ATVs can be hazardous to operate. Polaris adult models are for riders 16 and older. For your safety, always wear a helmet, eye protection and protective clothing, and be sure to take a safety training course. For safety and training information in the U.S., call the SVIA at (800) 887-2887. You may also contact your Polaris dealer or call Polaris at (800) 342-3764. ©2013 Polaris Industries Inc.



BE A SAFE SHOOTER

Read and follow all safety information in the owner's manual provided with each firearm before use. Additional copies are available for free download on the Browning website. Browning endeavors to make the safest firearms possible; however, firearm safety begins with you. At all times treat any firearm with intense respect for its power and potential danger. Always point the muzzle in a safe direction. There is no excuse for careless or abusive handling of any firearm.

BROWNING IS COMMITTED TO SERVING YOU

Every effort has been made to ensure that all product photographs, descriptions and specifications in this catalog are accurate; however, inadvertent errors may occur. Changes in design or materials due to our continual effort to improve products may result in specification changes before subsequent publications are issued. Browning reserves the right to modify or change specifications without notice.



BROWNING®

Browning • One Browning Place • Morgan, UT 84050-9326
Distributed in Canada by: Browning Canada Sports Ltd/Ltée
5583 Chemin St-François • St-Laurent, Quebec H4S 1W6

BROWNING.COM • 800-333-3288

©Copyright, Browning, September 2014. No part of this catalog may be reproduced without the written permission of Browning. Printed in U.S.A. GAC1408200/14076

PRICES IN US \$ / LES PRIX SONT EN \$ US