

# BROWNING®

2011





**SHOTGUNS ► BEGIN ON PAGE 2**

<b>10 GAUGE SHOTGUNS: Gold &amp; BPS</b>	<b>37</b>
<b>A-BOLT SHOTGUNS</b>	<b>4-5</b>
<b>AUTOLOADING SHOTGUNS</b>	
Maxus	6-11
Silver	3, 30-35
<b>BARRELS</b>	
BPS	44
Gold	36
Maxus	8
Silver	36
<b>BOLT-ACTION SHOTGUNS</b>	<b>4-5</b>
<b>BPS PUMP SHOTGUNS</b>	<b>38-43</b>
<b>BPS EXTRA BARRELS</b>	<b>44</b>
<b>BT-99 TRAP SHOTGUNS</b>	<b>28-29</b>
<b>CITORI OVER/UNDER SHOTGUNS</b>	<b>2, 12-19</b>
<b>CYNERGY ACCESSORIES</b>	<b>27</b>
<b>CYNERGY OVER/UNDER SHOTGUNS</b>	<b>20-27</b>
<b>GOLD EXTRA BARRELS</b>	<b>36</b>
<b>MAXUS AUTOLOADING SHOTGUNS</b>	<b>6-11</b>
<b>MAXUS EXTRA BARRELS</b>	<b>8</b>
<b>MICRO MIDAS</b>	<b>2-3</b>
<b>OVER AND UNDER SHOTGUNS</b>	
Citori	2, 12-19
Cynergy	20-27
<b>PUMP SHOTGUNS</b>	<b>38-43</b>
<b>SILVER AUTOLOADING SHOTGUNS</b>	<b>3, 30-35</b>
<b>SILVER EXTRA BARRELS</b>	<b>36</b>

Look for the following icons next to select shotguns to alert you to those ideally suited to clay target shooting:



**RIFLES ► BEGIN ON PAGE 45**

<b>A-BOLT RIFLES</b>	<b>53-59</b>
<b>A-BOLT MAGAZINES</b>	<b>60, 138</b>
<b>AUTOLOADING RIFLES</b>	<b>65-70</b>
<b>BAR RIFLES</b>	<b>65-70</b>
<b>BAR EXTRA MAGAZINES</b>	<b>69, 139</b>
<b>BAR RECOIL PADS</b>	<b>69</b>
<b>BL-22 RIFLES</b>	<b>3, 74</b>
<b>BLR RIFLES</b>	<b>61-64</b>
<b>BLR MAGAZINES</b>	<b>64, 139</b>
<b>BLR SCOUT MOUNT</b>	<b>63, 136</b>
<b>BOSS-CR ACCESSORY</b>	<b>60, 138</b>
<b>BUCK MARK RIFLES</b>	<b>76-77</b>
<b>CUSTOM SHOP</b>	<b>86-88</b>
<b>CENTERFIRE RIFLES</b>	
A-Bolt	53-59
BAR	65-70
BLR	61-64
X-Bolt	3, 45-52
<b>LEVER-ACTION RIFLES</b>	
BL-22	3, 74
BLR	61-64
<b>MAGAZINES</b>	
A-Bolt	60, 138
BAR	69, 139
BLR	64, 139
T-Bolt Double Helix	72, 139
X-Bolt	50, 137
<b>MOUNTS</b>	<b>63, 136</b>
<b>RECOIL PADS</b>	<b>69</b>
<b>RIMFIRE RIFLES</b>	
BL-22	3, 74
Buck Mark	76-77
SA-22	75
T-Bolt	71-73
<b>SA-22 RIFLES</b>	<b>75</b>
<b>T-BOLT RIFLES</b>	<b>71-73</b>
<b>T-BOLT DOUBLE HELIX MAGAZINES</b>	<b>72, 139</b>
<b>X-BOLT RIFLES</b>	<b>45-52</b>
<b>X-BOLT EXTRA MAGAZINES</b>	<b>50, 137</b>

**PISTOLS ► BEGIN ON PAGE 78**

<b>1911-22</b>	<b>78-79</b>
<b>1911-22 MAGAZINES</b>	<b>79, 139</b>

<b>BUCK MARK</b>	<b>80-83</b>
<b>BUCK MARK MAGAZINES</b>	<b>80, 139</b>
<b>HI POWER</b>	<b>84-85</b>
<b>HI POWER 75TH ANNIVERSARY</b>	<b>85</b>
<b>HI POWER MAGAZINES</b>	<b>85, 139</b>

**SAFES ► BEGIN ON PAGE 89**

<b>ACCESSORY/OPTION INFORMATION</b>	
Factory-Installed Accessories	114
Game Scenes	111
Heritage Graphics	111
Lock Options	114
User-Installed Accessories	113

<b>FEATURE INFORMATION</b>	
Axis Adjustable Shelving	90
DPX Storage System	91
Competitive Comparison	93
Feature Guide	94
Pry and Fire Resistance	92
Storage Solutions/Interiors	90-91
Understanding Safe Features	95

**SAFES: PREMIUM**

Gold Series	98-99
Medallion Series	100-101
Platinum Plus Series	96-97
Silver Series	102-103

**SAFES: VALUE**

Bronze Series	104-105
Compact Series	105
TheftGard	106-107

**SAFES: SPECIALTY**

Heritage Graphics	111
Security Door	112
Select Series	110
Tactical Series	108-109
Universal Vault Door	112

**SUPPORTING INFORMATION**

Warranty	114
----------	-----

**GUN CASES ► BEGIN ON PAGE 115**

<b>FLOATER CASE</b>	<b>123</b>
<b>FITTED PRESENTATION CASES</b>	
Canvas Over/Under	119
Crazy Horse Distressed Leather	116
High Grade Canvas/Crazy Horse Leather	116
John M. Browning Signature	115
Leather/Canvas Series	117
Leather/Canvas Motor	117
Santa Fe Waxed Canvas	116
Sporter	119
Traditional	118
Wild Boar	117

**FLEXIBLE CASES**

Bear River Floater	123
Birch Creek	121
Cimmaron	122
Flex Foam Buck Mark Pistol	124
Plainsman	122
Santa Fe	121
Skimmer	123
Talon	123
Wild Boar	121

**GUN SLIPS, PLAINSMAN**

	122
--	-----

**GUN SOCKS**

	124
--	-----

**MOLDED CASES**

Mirage	120
Bruiser	120

**TALON ALUMINUM CASES**

	119
--	-----

**BOOKS ► BEGIN ON PAGE 124**

<b>ARS MECHANICA</b>	<b>124</b>
<b>JOHN M. BROWNING BIOGRAPHY</b>	<b>124</b>

**GUN ACCESSORIES ► BEGIN ON PAGE 125**

<b>BAGS</b>	
Shooting	125-127
Hunting	128-129
<b>CARTRIDGE CASES</b>	<b>143</b>
<b>CHOKE TUBES</b>	
Flush Tubes	146
Extended Tubes	147-148
Specialty Tubes	148-149
Wrenches	146-149
<b>CHOKE TUBE CASES</b>	<b>145</b>
<b>CLEANING ACCESSORIES</b>	<b>153</b>
<b>COMBO KITS</b>	<b>144</b>
<b>GUNSLINGER</b>	<b>134</b>
<b>HEARING PROTECTION</b>	<b>150-151</b>
<b>HUNTING ACCESSORIES</b>	<b>143</b>

<b>MAGAZINES</b>	<b>137-139</b>
<b>MOA SHOOTING STICKS</b>	<b>135</b>
<b>RIMFIRE PISTOL ACCESSORIES</b>	<b>140-142</b>
<b>SCOPE RINGS AND BASES</b>	<b>136-137</b>
<b>SHOOTING GLASSES</b>	<b>152</b>
<b>SIGHTS</b>	<b>142, 145</b>
<b>SLINGS</b>	
Synthetic Slings	130-132
Leather Slings	132-133
<b>SNAP CAPS</b>	<b>149</b>

**KNIVES ► BEGIN ON PAGE 154**

<b>CAMPING KNIVES</b>	
Backcountry Series	170
Campmate Knife	173
Camp Saws	173
<b>COLLECTIBLE KNIVES</b>	
Crowell/Barker Competition	170
Presentation Lockback	171
Scrimshaw	158
Whitetail Legacy	157
<b>HUNTING AND FISHING KNIVES</b>	
Backcountry	170
Backtrack Folders	168
Big Game Series	163
Big Game Stag	163
Browning 111 Folding	168
Classic Series	162
Escalade Series	160
Extreme Mountain Hunter	164
For Her Series	156
Guide's Choice	160
Hard Core Hunter Combos	159
Independence	155
Kodiak F.D.T.	167
Lil' Bit	165
Obsession Series	167
Outdoorsman Fillet	161
Packer Series	166
Tactical Hunter Series	163
Woodsman Bird and Trout	161

**KITCHEN KNIVES**

Outdoorsman Steak Knives	172
Outdoorsman Kitchen Cutlery Set	172

**POCKET KNIVES**

Backdraft Assisted Opening	158
Chinook	172
Fast Task Series	171
Gunstock Series	171
Mountain Ti	169
Prism II	169

**LIGHTS ► BEGIN ON PAGE 174**

**ACCESSORIES/BULBS/BATTERIES**

	186
--	-----

**CAP LIGHTS**

Night Seeker Cap Lights	184
Night Seeker Pro Cap Light	184

**FLASHLIGHTS**

Alpha and Alpha Max	177
Catalyst	178
Duck Call Lanyard	180
Hi Power	176
Hunt Master	178
MicroBlast	181
Pro Hunter	179
Spitfire	180
Tactical Hunter	175, 178
Zeta	177

**HEADLAMPS/CAP LIGHTS**

MicroBlast Headlamp	183
Night Seeker Cap Lights	184
Night Seeker Pro Cap Light	184
Nitro Headlamp	177
Phantom Headlamp	183
Pro Hunter Headlamps	182
Renegade Headlamps	183

**KEYCHAIN LIGHTS**

Choke Tube	185
Echo	185
Night Seeker Pocket	180

**KNIFE/LIGHT COMBOS**

	181
--	-----

**LANTERNS**

	186
--	-----

**PEN LIGHTS**

	181
--	-----

**CLOTHING ► BEGINS ON PAGE 187**

**ADDHEAT**

Battery Pack/Control Module	200
Soft Shell AddHeat	200
Vehicle Charger	200



<b>BLAZE</b>	
Big Country Vest	224
Caps	245
Hell's Canyon	204
Safety Vest	224
<b>BIG GAME</b>	
4X Microfleece	210
650 Down	213
700 Fill Power Down	195
Blaze	204
Deluge	198
Dillon/WindKill	197
Full Curl Wool	214-217
Hell's Canyon	204-205
Highlands II Wool	218-219
Hydro-Fleece PrimaLoft and Soft Shell	189-191
Illusion	196
Maxus HMX Jacket	199
TF-300 Fleece	211
Transitions Series	192-199
Wasatch	220-223
XPO Big Game	201-203
<b>CAPS AND HATS</b>	
Camo	245-247
Casual	243-244
Felt Hats	247
Safety	245
Wax Fabric	244

<b>DOWN</b>	
650 Down	213
700 Fill Power Down	195
Santa Fe Down Jacket	212
<b>FIELDWEAR</b>	
Illusion	196
Wasatch	220-223
<b>FOR HER</b>	
Full Curl Wool	216
Mohave Short Sleeve Shirt	239
Sporter II Shooting Vest	239
Trapper Creek Shooting Gloves	242
Wasatch	222
XPO Big Game	203
<b>JUNIOR</b>	
Safety Vest	224
Dusty Mesh Shooting Vest	237
TF-300 Fleece	211
Wasatch	222
XPO Big Game	203
<b>SHOOTING CLOTHING</b>	
Badger Creek Shirts	241
Ballistic Insulated Shooting Jacket	242
Broken Birds Vest	238
Deluxe Mesh Vest	240
Dusty Mesh Vest	237
Leather Tac-Pro Gloves	242
Mesh Back Shooting Gloves	242
Mohave Short Sleeve Shirts	239, 241
REACTAR Pad, Harness and Shirt	236
Santa Fe Pro Vest	240
Sporter II Shooting Vest For Her	239

SXS Vest	240
Trapper Creek Half Vest	238
Trapper Creek Mesh Gloves	242
<b>SIZING CHART</b>	<b>247</b>



<b>TRANSITIONS SERIES</b>	
700 Fill Power Down	195
Comfort Fleece	194
Deluge	198
Dillon WindKill	197
Maxus HMX Jacket	199
NTS Pro	193
PrimaLoft	195

<b>TRANSITIONS: BASE LAYER</b>	
NTS Pro	193
Comfort Fleece	194

<b>TRANSITIONS: INSULATION LAYER</b>	
PrimaLoft	195
700 Fill Power Down	195

<b>TRANSITIONS: PROTECTION LAYER</b>	
Deluge	198
Dillon WindKill	197
Illusion	196
Maxus HMX Jacket	199

<b>UPLAND CLOTHING</b>	
Bird'n Lite	228-231
Cross Country	232
Cross Country Upland Pro	233
Deluge	198
Dove Polo Shirts	234

Game Vests and Bags	226, 230, 235
Pheasants Forever	225-231
Prairielands Shirts	234
Sweatshirts and Sweaters	223

<b>WATERFOWL</b>	
4X Microfleece	210
650 Down	213
700 Fill Power Down	195
Deluge	198
Maxus HMX Jacket	199
PrimaLoft Liner Jacket	195
Santa Fe Down	212
Transitions	194-196, 198-199
Warm Front	209
Wasatch	220-221, 223
Windcutter	209
Wing-Set Jacket	208
XPO Grand Passage	206-207

<b>WOOL</b>	
Full Curl	214-217
Highlands II	218-219

**BUCKMARK DECALS** ▶ BEGIN ON PAGE 248

**PRO STAFF** ▶ BEGINS ON PAGE 249

**OTHER PRODUCTS** ▶ BEGIN ON PAGE 251

AIR GUNS	255
AUTOMOTIVE	253
BED AND BATH	254
BELTS	251
CAMPING	256
CASUAL SPORTSWEAR	253
OUTDOOR COOKWARE	251
EYEWEAR	252
FISHING	255
FOOTWEAR	252
GIFTS	253
HITCHES	251
SOCKS	252
SPORTING BAGS/TRAVEL GEAR	256
POLARIS ALL TERRAIN VEHICLES	Inside Back Cover



**ALPHABETICAL INDEX**

The index in this catalog lets you locate products faster. An alphabetical listing (by end use) of all Browning products is shown on these two pages. In addition, a quick reference index is located at the beginning of each product section (found on the index page noted in colored header bars).

**MOSSY OAK® BREAK-UP® INFINITY™ CAMOUFLAGE**

Mossy Oak® Break-Up® Infinity™ provides true three-dimensional camouflage with depth and realism that will make you virtually disappear in the woods. Look for the Infinity logo and color swatch for the guns and gear available in this pattern.



2011

HUNTING AND SHOOTING



# MICRO MIDAS

## MICRO MIDAS — TOP QUALITY, COMPACT SIZES.

In the past, finding a high-quality firearm built for younger or smaller shooters was difficult. Those days are over thanks to the new line of Browning Micro Midas guns. Micro Midas guns are sized to fit smaller shooters in every way — they are slimmer, lighter and have shorter lengths of pull. They are also built to the same high standard of quality you trust from Browning. When you buy a new Micro Midas firearm, you are eligible to participate in the Growth Insurance Program that allows the shotgun to grow with the shooter.



All Browning firearms are shipped with a free locking device to assist in the safe storage of firearms.



**BROWNING GROWTH INSURANCE PROGRAM** It's a fact, kids grow. Which makes purchasing a firearm for them a difficult decision. Should you buy an inexpensive "youth" model with questionable quality that they will soon grow out of? Or should you buy a well-made, but ill-fitting, full-size firearm that won't let them shoot to their potential because of poor fit? Fortunately, Browning offers the perfect solution for both now and later with the Growth Insurance Program. For a limited time, with the purchase of a new Browning Micro Midas or Micro firearm, you are eligible to purchase a full-size stock at 50% off the retail price. That's a big savings for you, and allows them to enjoy a firearm of the highest quality that is sure to fit and maximize their shooting performance and enjoyment for years to come. Visit [browning.com](http://browning.com) for complete details.

**CITORI SATIN HUNTER MICRO MIDAS** ► GAUGE: 12 (SHOWN), 20 | SATIN FINISH STOCK AND FOREARM

**NEW**



**RECEIVER** - Steel · Blued finish  
**BARREL** - Ventiladed rib  
**ACTION** - Single selective trigger  
 · Hammer ejectors · Top-tang barrel selector/safety

**STOCK** - Satin finish walnut  
 · Compact stock with 13" length of pull  
**FEATURES** - Vector Pro™ lengthened forcing cone  
 · Three Invector-Plus™ choke tubes · Recoil pad on 12 gauge model · Ivory front bead sight

	GA.	BARREL LENGTH	CODE NUMBER	UPC#	CHOKES INCLUDED	CHAMBER	*AVG. WEIGHT	OVERALL LENGTH	DROP AT COMB	DROP AT HEEL	LENGTH OF PULL	RIB WIDTH	SUGG. RETAIL
<b>NEW</b>	12	26"	013497305	023614071259	F, M, IC	3"	6 lbs. 11 oz.	41¾"	1¾"	2½"	13"	⅝"	\$1,469.99
<b>NEW</b>	12	24"	013497306	023614071266	F, M, IC	3"	6 lbs. 9 oz.	39¾"	1½"	2½"	13"	⅝"	1,469.99
<b>NEW</b>	20	26"	013497605	023614071273	F, M, IC	3"	6 lbs. 4 oz.	41¾"	1½"	2¾"	13"	¼"	1,469.99
<b>NEW</b>	20	24"	013497606	023614071280	F, M, IC	3"	6 lbs. 2 oz.	39¾"	1½"	2¾"	13"	¼"	1,469.99

\*NOTE: Weights listed are approximate.



**SILVER HUNTER MICRO MIDAS** ▶ GAUGE: 12 (SHOWN), 20 | SATIN FINISH STOCK AND FOREARM

**NEW**



**RECEIVER** - Strong, lightweight aluminum alloy  
 · Semi-humpback design · Silver finish  
**BARREL** - Lightweight profile · Ventilated rib  
**ACTION** - Gas-operated autoloader · 3" chamber  
 · Active Valve reliably cycles a wide range of loads  
**STOCK** - Satin finish walnut stock and forearm  
 · Compact 13" length of pull for smaller shooters  
**FEATURES** - Three Invector-Plus™ choke tubes  
 · Ivory front bead sight · One ¼" stock spacer

	GA.	BARREL LENGTH	CODE NUMBER	UPC#	CHOKES INCLUDED	CHAMBER	*AVG. WEIGHT	OVERALL LENGTH	DROP AT COMB	DROP AT HEEL	LENGTH OF PULL	RIB WIDTH	SUGG. RETAIL
<b>NEW</b>	12	26"	011389305	023614071013	F, M, IC	3"	7 lbs. 5 oz.	45¾"	1½"	1¾"	13"	¼"	\$1,069.99
<b>NEW</b>	12	24"	011389306	023614071020	F, M, IC	3"	7 lbs. 3 oz.	43¾"	1½"	1¾"	13"	¼"	1,069.99
<b>NEW</b>	20	26"	011389605	023614071037	F, M, IC	3"	6 lbs. 2 oz.	45¾"	1½"	1¾"	13"	¼"	1,069.99
<b>NEW</b>	20	24"	011389606	023614071044	F, M, IC	3"	6 lbs.	43¾"	1½"	1¾"	13"	¼"	1,069.99

\*NOTE: Weights listed are approximate.

**X-BOLT MICRO MIDAS** ▶ SATIN FINISH STOCK

**NEW**



**RECEIVER** - Steel · Low-luster blued finish · Glass bedded · Drilled and tapped for scope mounts  
**BARREL** - Low-luster blued finish · Free-floating  
 · Hand chambered · Target crown  
**ACTION** - Bolt-action · 60° bolt lift  
 · Adjustable Feather Trigger™ · Detachable rotary magazine · Top-tang safety · Bolt unlock button

**STOCK** - Satin finish checkered walnut stock · Compact 12½" length of pull for smaller shooters  
**FEATURES** - Sling swivel studs installed · Inflex Technology recoil pad  
 (Scope and mounts not included)

(SSA) = Super-Short Action, (SA) = Short Action

	CALIBER	BARREL LENGTH	CODE NUMBER	UPC #	*TOTAL CAPACITY	**AVG. WEIGHT	OVERALL LENGTH	SIGHT RADIUS	***DROP AT COMB	DROP AT HEEL	LENGTH OF PULL	RATE OF TWIST	SUGG. RETAIL
<b>NEW</b>	(SSA) 22-250 Rem.	20"	035249209	023614071174	5	6 lbs. 1 oz.	37⅞"	—	1⅛"	½"	12½"	1 in 14"	\$799.99
<b>NEW</b>	(SA) 243 Win.	20"	035248211	023614071181	5	6 lbs. 1 oz.	38⅞"	—	1⅛"	½"	12½"	1 in 10"	799.99
<b>NEW</b>	(SA) 7mm-08 Rem.	20"	035248216	023614071198	5	6 lbs. 1 oz.	38⅞"	—	1⅛"	½"	12½"	1 in 9½"	799.99
<b>NEW</b>	(SA) 308 Win.	20"	035248218	023614071204	5	6 lbs. 1 oz.	38⅞"	—	1⅛"	½"	12½"	1 in 12"	799.99

NOTE: \*Total capacity includes one round in the chamber. \*\*Weights listed are approximate. \*\*\*Measured from centerline of bore.

**BL-22 GRADE I MICRO MIDAS** ▶ GLOSS FINISH STOCK AND FOREARM

**NEW**



**RECEIVER** - Steel · Blued finish  
 · Grooved for scope mounts  
**BARREL** - Blued finish · Recessed crown  
**ACTION** - Lever-action · Short 33° throw  
 · Tubular magazine

**STOCK** - Gloss finish American walnut · Straight grip · Compact 12" length of pull for smaller shooters  
**FEATURES** - Adjustable sights

	CALIBER	BARREL LENGTH	CODE NUMBER	UPC #	*TOTAL CAPACITY	**AVG. WEIGHT	OVERALL LENGTH	SIGHT RADIUS	***DROP AT COMB	DROP AT HEEL	LENGTH OF PULL	RATE OF TWIST	SUGG. RETAIL
<b>NEW</b>	22 L.R.	19⅞"	024115103	023614071242	12	4 lbs. 12 oz.	31½"	11⅞"	7/8"	1½"	12"	1 in 16"	\$479.99

NOTE: \*Total capacity includes one round in the chamber. \*\*Weights listed are approximate. \*\*\*Measured from centerline of bore.



# A-BOLT

## SHOTGUNS INDEX

10 GAUGE SHOTGUNS: Gold & BPS	37
A-BOLT	4-5
<b>AUTOLOADING SHOTGUNS</b>	
Maxus	6-11
Silver	3, 30-35
<b>BARRELS</b>	
BPS	44
Gold	36
Maxus	8
Silver	36
<b>BOLT-ACTION SHOTGUNS</b>	
BPS PUMP SHOTGUNS	38-43
BPS EXTRA BARRELS	44
BT-99 TRAP SHOTGUNS	28-29
CITORI OVER/UNDER SHOTGUNS	2, 12-19
CYNERGY ACCESSORIES	27
CYNERGY OVER/UNDER SHOTGUNS	20-27
GOLD EXTRA BARRELS	36
MAXUS AUTOLOADING SHOTGUNS	6-11
MAXUS EXTRA BARRELS	8
MICRO MIDAS	2-3
<b>OVER AND UNDER SHOTGUNS</b>	
Citori	2, 12-19
Cynergy	20-27
<b>PUMP SHOTGUNS</b>	
SILVER AUTOLOADING SHOTGUNS	3, 30-35
SILVER EXTRA BARRELS	36

**A-BOLT SHOTGUNS — RUGGED AND ACCURATE.** Since many areas prohibit the use of rifles, the popularity of shotguns for deer hunting continues to rise. If you prefer the feel of a bolt-action, our accurate A-Bolt shotguns look, handle and feel like an A-Bolt rifle, and feature the same fast-cycling 60° bolt lift, easy-to-reach top-tang safety, and the sweet trigger feel as the rifles you know. An adjustable rear sight is included, and the receiver is tapped and ultra stable for scope mounts. Want pinpoint groups at 100 yards with sabots? Get an A-Bolt shotgun today.

All Browning firearms are shipped with a free locking device to assist in the safe storage of firearms.

**STOCK** The rugged composite stock features the familiar close radius pistol grip of the A-Bolt rifle. Textured surfaces and Dura-Touch® Armor Coating provide a secure grip.



**BARREL** The A-Bolt shotgun features a fully rifled 1 in 28" twist barrel designed exclusively for use with sabot-type slugs. You can expect superb accuracy with the A-Bolt shotgun with 1½" groups or better at 100 yards.



### PERFORMANCE

The smooth, anti-bind performance of our A-Bolt centerfire rifles is also found in the A-Bolt shotgun action.

**DETACHABLE MAGAZINE** A detachable magazine on a hinged floorplate allows you to quickly reload. 2 + 1 capacity. Extra magazines can be carried for fast reloading.





**A-BOLT SHOTGUN HUNTER** ▶ GAUGE: 12 | SATIN FINISH STOCK

**NEW**



**RECEIVER** - Steel · Low-luster blued finish  
 · Drilled and tapped for scope mounts  
**BARREL** - Low-luster blued finish  
**ACTION** - 3" chamber · Bolt-action · 60° bolt lift  
 · Detachable two-round magazine · Top-tang safety

**STOCK** - Satin finish walnut stock and forearm  
 · Checkered  
**FEATURES** - Sling swivel studs installed  
 · Recoil pad · TRUGLO®/Marble's® fiber-optic front sight · Rear sight adjustable for windage and elevation

**A-BOLT SHOTGUN STALKER** ▶ GAUGE: 12 | DURA-TOUCH® ARMOR COATING ON STOCK

**NEW**



**DURA-TOUCH®**  
 Armor Coating

**RECEIVER** - Steel · Low-luster blued finish  
 · Drilled and tapped for scope mounts  
**BARREL** - Low-luster blued finish  
**ACTION** - 3" chamber · Bolt-action · 60° bolt lift  
 · Detachable two-round magazine · Top-tang safety

**STOCK** - Composite stock and forearm  
 · Textured gripping surfaces · Dura-Touch® Armor Coating  
**FEATURES** - Sling swivel studs installed  
 · Recoil pad · TRUGLO®/Marble's® fiber-optic front sight · Rear sight adjustable for windage and elevation

**A-BOLT SHOTGUN, MOSSY OAK® BREAK-UP® INFINITY™** ▶ GAUGE: 12 | DURA-TOUCH® ARMOR COATING ON STOCK

**NEW**



**RECEIVER** - Steel · Low-luster blued finish  
 · Drilled and tapped for scope mounts  
**BARREL** - Low-luster blued finish  
**ACTION** - 3" chamber · Bolt-action · 60° bolt lift  
 · Detachable two-round magazine · Top-tang safety  
**STOCK** - Composite stock and forearm  
 · Textured gripping surfaces · Mossy Oak® Break-Up® Infinity™ camo finish · Dura-Touch® Armor Coating  
**FEATURES** - Sling swivel studs installed  
 · Recoil pad · TRUGLO®/Marble's® fiber-optic front sight · Rear sight adjustable for windage and elevation



**DURA-TOUCH®**  
 Armor Coating

	GA.	BARREL LENGTH	CODE NUMBER	UPC #	CHAMBER	*AVG. WEIGHT	OVERALL LENGTH	SIGHT RADIUS	DROP AT COMB	DROP AT HEEL	LENGTH OF PULL	RATE OF TWIST	SUGG. RETAIL
<b>A-BOLT SHOTGUN HUNTER</b>													
<b>NEW</b>	12	22"	015001120	023614072027	3"	7 lbs. 2 oz.	43¾"	15½"	⅝"	½"	14"	1 in 28"	\$1,199.99
<b>A-BOLT SHOTGUN STALKER</b>													
<b>NEW</b>	12	22"	015003120	023614072034	3"	7 lbs.	43¾"	15½"	⅝"	½"	14"	1 in 28"	\$1,099.99
<b>A-BOLT SHOTGUN MOSSY OAK BREAK-UP INFINITY</b>													
<b>NEW</b>	12	22"	015005120	023614072041	3"	7 lbs.	43¾"	15½"	⅝"	½"	14"	1 in 28"	\$1,239.99



# MAXUS®

## THE BROWNING MAXUS — MAXIMUM RELIABILITY.

The high performance Browning Maxus is the most exciting autoloading shotgun in decades. Innovative technologies join together and deliver up to 18% less felt recoil for greater comfort, 44% less muzzle jump for more accurate follow-up shots, 19% faster bolt speed and 24% faster locktime than the nearest competitor. Other conveniences like the Speed Lock Forearm and TurnKey Magazine Plug further elevate the Maxus. Shoot a Maxus today and you'll agree it is the finest, most reliable 3½" autoloader ever built.

### LESS MUZZLE JUMP

Less felt recoil means less muzzle jump and that instantly translates into more birds in your bag. The Power Drive Gas System works perfectly with the Inflex Technology recoil pad to reduce muzzle jump as much as 44% compared to the competition.

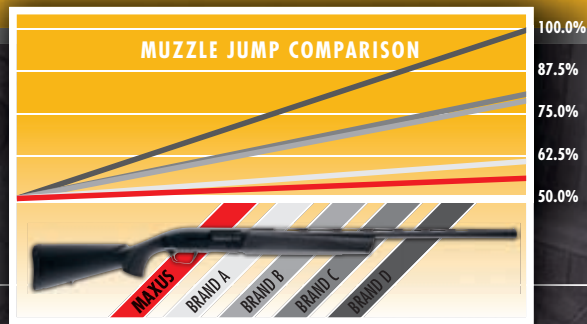

### POWER DRIVE GAS SYSTEM

The Power Drive Gas System is the world's finest. Extensive research and testing have resulted in a piston design that's more reliable in all conditions, regardless of heavy or light loads being used. The gas piston features larger exhaust ports that dump gases faster on heavy loads. A patented, enclosed seal design keeps residue out of the action for cleaner operation. The piston has a 20% longer stroke travel to be even more reliable with light loads. Maxus with Power Drive equals outstanding performance.



### INFLEX TECHNOLOGY RECOIL PAD

The Inflex Technology recoil pad is the softest pad on any autoloader. More than a mass of recoil absorbing material, it has been engineered with directional deflection to pull the comb down and away from your face with every shot for even greater comfort and faster follow-up shooting.

### THE SOFTEST SHOOTING AUTOLOADER EVER

Felt recoil is more than just an instantaneous peak force, it is the total energy absorbing experience when you fire a shell. While no recoil reduction system can escape the laws of physics, the Maxus will change your mind about recoil control. The Power Drive Gas System, Inflex Technology recoil pad, Vector Pro™ back-boring and natural Browning balance combine to transfer up to 18% less total felt recoil force to your shoulder than other autoloaders on the market.

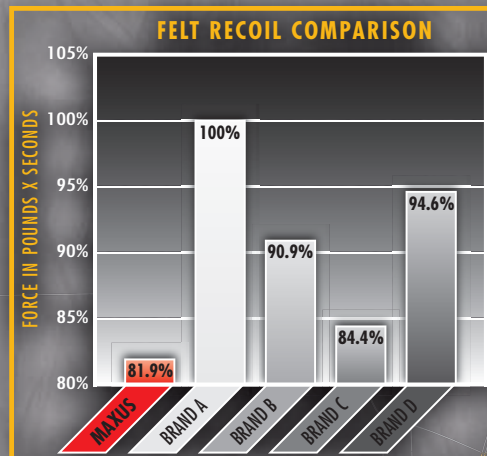

### SPEED LOCK FOREARM

For the Maxus, our engineers stepped outside the box, then put a target on it. Gone is the traditional bulky screw-on magazine cap, replaced with the patented Speed Lock Forearm. This secure forearm attachment system makes taking down the Maxus for cleaning or storage faster and easier than ever before, and makes attaching or removing a sling a snap.



# TOTAL BARREL DYNAMICS

## INVECTOR-PLUS™ CHOKE SYSTEM

The proven Invector-Plus interchangeable choke tube system works with Vector Pro™ and back-boring to offer consistent, dense shot patterns with just the constriction needed for the shooting situation. The longer choke taper inside an Invector-Plus choke tube produces consistent patterns with more uniform densities and fewer fliers. The superior design of the Invector-Plus system is far more durable than the choke systems found in our competitors' guns, especially when shooting steel shot. Invector-Plus eliminates gases slipping between the choke tube and barrel that could damage the choke tube and the barrel. See page 146 through 149 for a complete listing of choke tubes.

All Browning firearms are shipped with a free locking device to assist in the safe storage of firearms.



The competition's choke tube is grooved and pitted after shooting 500 rounds of steel shot.



Browning's Invector-Plus choke tube is still flawless after 500 rounds of steel.

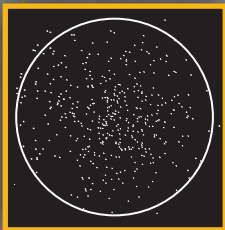
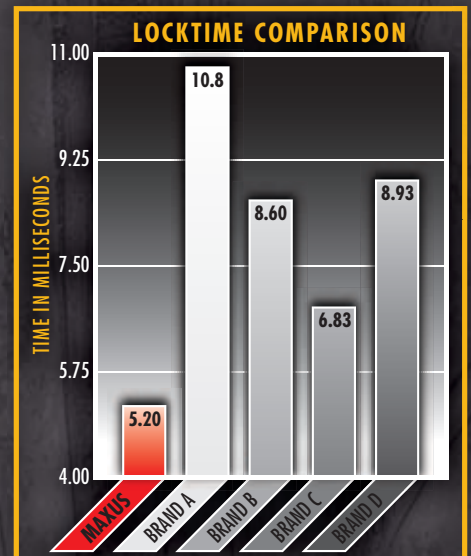

Browning pattern with Back-Bored Technology

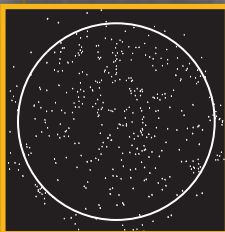

The competitors' pattern without Back-Bored Technology

## VECTORPRO™

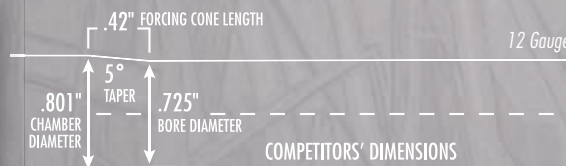

## VECTOR PRO™ LENGTHENED FORCING CONE

We were the first manufacturer to recognize the advantages of a back-bored barrel and make it a standard feature on shotguns. Now we have gone a step further with Vector Pro, featuring a lengthened forcing cone that is over 2" longer than other systems. This long, gradual taper minimizes shot deformation and maximizes pattern uniformity, consistency and density. Back-boring increases bore diameter to its maximum specification, reducing friction between the shot cup and the bore to propel the shot pellets to a higher velocity and reduce felt recoil. Reducing constriction from the forcing cone on the shot column results in fewer deformed pellets for more uniform patterns, and keeps more pellets in the central part of the pattern where they need to be to bag birds and dust targets. Our back-bore specifications represent the ideal bore diameter. A larger bore diameter can let gases slip by the shot cup, resulting in both reduced pellet velocity and blown patterns. A smaller bore diameter means the forcing cone can deform pellets, leading to poor ballistic performance and uneven, spotty pellet coverage on your target.

## STEEL SHOT PERFORMANCE

Our barrels are made to handle the punishment of steel shot. Unlike some manufacturers whose guns face an uncertain future after shooting steel, we have long been at the forefront of dependable steel shot performance and durability. Our barrels meet the strictest material and construction quality standards. The barrel blanks are made from rolled and tempered steel bars and are stress relieved to offer exceptional mechanical properties. The barrel blanks are then precision drilled, reamed and honed to exacting specifications. Browning Maxus barrels will last.



The forcing cone of the competition is pitted and damaged beyond repair after 500 rounds of steel shot.



After 500 rounds of steel shot, the higher-quality Browning barrel shows no wear.





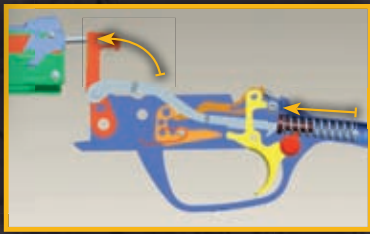

## LIGHTNING TRIGGER

The Lightning Trigger System is the finest ever offered in an autoloading shotgun, designed to offer a smooth, crisp feel with minimal travel. With locktimes averaging .0052 seconds, the Lightning Trigger is 24% faster than the nearest competing autoloader, making every pull perfect. It's also easy to remove for cleaning.

## OPTIMAL DIMENSIONS

Innovation is rampant throughout the Maxus, and it carries into fit and handling. The Maxus features a trim forearm and close radius pistol grip to maximize control. A relieved steel magazine tube reduces weight allowing a faster swing while maintaining durability. Drop and cast can be tuned using the included stock shim kit. An externally relieved magazine tube reduces weight and adds strength. A low rib is in line with the top of the receiver and translates into a flat point of impact.



## MAGAZINE CUT-OFF

The Maxus is equipped with a magazine cut-off that allows you to easily unload the chamber to change loads without cycling a shell from the magazine.



## TURNKEY MAGAZINE PLUG

The patented TurnKey Magazine Plug is easily removed in seconds using a vehicle key. Combined with the Speed Lock System, the magazine plug can be removed from the Maxus in mere seconds.

## MAXIMUM GRIP

Composite Maxus models combine in-molded textured gripping surfaces and our proven Dura-Touch® Armor Coating for a sure hold and a sleek feel in all climate conditions.



## SPEED LOAD PLUS

Speed Loading has been popular on Browning autoloaders for decades. Our patented feeding system sends the first shell loaded into the magazine directly into the chamber. Now, unloading is just as easy with the Maxus. The Speed Unload feature makes emptying the magazine fast and easy, without having to cycle and chamber every shell with the bolt handle.

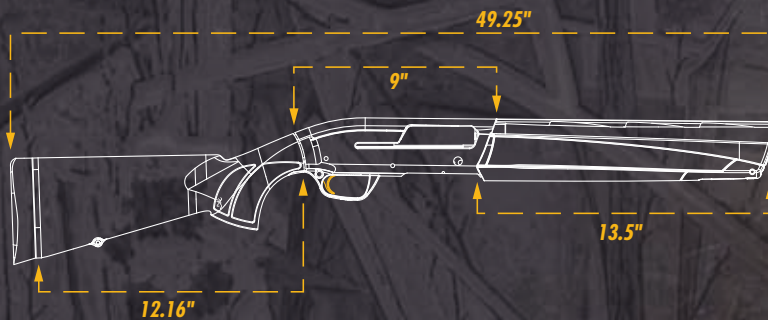

## MAXUS EXTRA BARRELS

**NEW**

MODEL	GA.	BARREL LENGTH	CODE NUMBER	UPC #	CHOKES INCLUDED	CHAMBER	RATE OF TWIST	SUGG. RETAIL
<b>NEW</b> Hunter	12	30"	111608303	023614071808	F, M, IC	3"	—	\$339.99
<b>NEW</b> Hunter	12	28"	111608304	023614071815	F, M, IC	3"	—	339.99
<b>NEW</b> Hunter	12	26"	111608305	023614071822	F, M, IC	3"	—	339.99
<b>NEW</b> Hunter	12	30"	111608203	023614071884	F, M, IC	3½"	—	419.99
<b>NEW</b> Hunter	12	28"	111608204	023614071891	F, M, IC	3½"	—	419.99
<b>NEW</b> Hunter	12	26"	111608205	023614071907	F, M, IC	3½"	—	419.99
<b>NEW</b> Stalker	12	28"	111600304	023614071839	F, M, IC	3"	—	339.99
<b>NEW</b> Stalker	12	26"	111600305	023614071846	F, M, IC	3"	—	339.99
<b>NEW</b> Stalker	12	28"	111600204	023614071914	F, M, IC	3½"	—	419.99
<b>NEW</b> Stalker	12	26"	111600205	023614071921	F, M, IC	3½"	—	419.99
<b>NEW</b> MODB	12	28"	111601304	023614071853	F, M, IC	3"	—	379.99
<b>NEW</b> MODB	12	26"	111601305	023614071860	F, M, IC	3"	—	379.99
<b>NEW</b> MODB	12	28"	111601204	023614071938	F, M, IC	3½"	—	439.99
<b>NEW</b> MODB	12	26"	111601205	023614071945	F, M, IC	3½"	—	439.99
<b>NEW</b> Rifled Deer Stalker	12	22"	111620321	023614071877	Rif. Bbl./Cant.	3"	1 in 28"	459.99





**MAXUS HUNTER** ▶ GAUGE: 12 | GLOSS FINISH STOCK AND FOREARM

**NEW**



**RECEIVER** - Strong, lightweight aluminum alloy  
 · Durable satin nickel finish · Laser engraving (pheasant on the right, mallard on the left)  
**BARREL** - Lightweight profile · Flat, ventilated rib  
**ACTION** - Gas-operated autoloader · 3" and 3½" chamber models · Power Drive Gas System reduces recoil and cycles a wide range of loads

**STOCK** - Gloss finish walnut stock with close radius pistol grip · Sharp 22 lines-per-inch checkering · Speed Lock Forearm · Shim adjustable for length of pull, cast and drop  
**FEATURES** - Vector Pro™ lengthened forcing cone · Three Invector-Plus™ choke tubes · Inflex Technology recoil pad · Ivory front bead sight · One ¼" stock spacer



Left engraving



Right engraving

**MAXUS ALL-PURPOSE, MOSSY OAK® BREAK-UP® INFINITY™** ▶ GAUGE: 12 | DURA-TOUCH® ARMOR COATING ON STOCK AND FOREARM

**NEW**

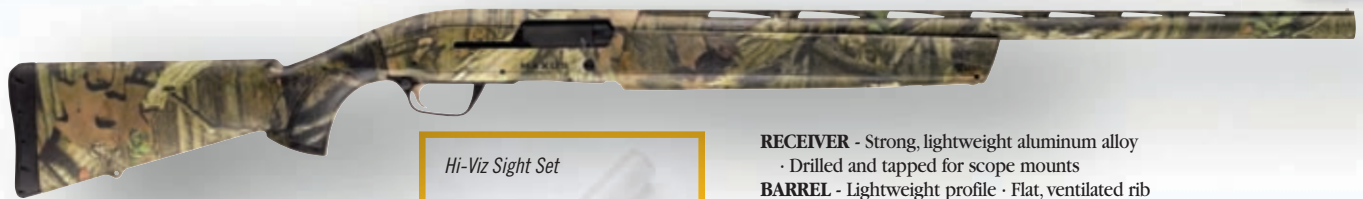

**DURA-TOUCH®**  
Armor Coating



Hi-Viz Sight Set

**RECEIVER** - Strong, lightweight aluminum alloy  
 · Drilled and tapped for scope mounts  
**BARREL** - Lightweight profile · Flat, ventilated rib  
**ACTION** - Gas-operated autoloader · 3½" chamber · Power Drive Gas System reduces recoil and cycles a wide range of loads  
**STOCK** - Composite stock with close radius pistol grip · Speed Lock Forearm · Textured gripping surfaces · Shim adjustable for length of pull, cast and drop · Mossy Oak® Break-Up® Infinity™ camo finish · Dura-Touch® Armor Coating  
**FEATURES** - Vector Pro™ lengthened forcing cone · Four Invector-Plus™ choke tubes (XF Turkey Tube included) · HiViz® 4-in-1 fiber-optic sight set · Inflex Technology recoil pad · Ivory front bead sight · One ¼" stock spacer

**MAXUS RIFLED DEER, MOSSY OAK® BREAK-UP® INFINITY™** ▶ GAUGE: 12 | DURA-TOUCH® ARMOR COATING ON STOCK AND FOREARM

**NEW**

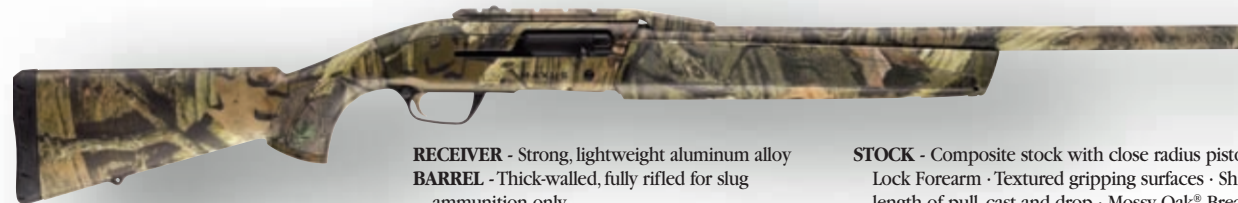

**DURA-TOUCH®**  
Armor Coating

**RECEIVER** - Strong, lightweight aluminum alloy  
**BARREL** - Thick-walled, fully rifled for slug ammunition only  
**ACTION** - Gas-operated autoloader · 3" chamber · Power Drive Gas System reduces recoil and cycles a wide range of loads

**STOCK** - Composite stock with close radius pistol grip · Speed Lock Forearm · Textured gripping surfaces · Shim adjustable for length of pull, cast and drop · Mossy Oak® Break-Up® Infinity™ camo finish · Dura-Touch® Armor Coating  
**FEATURES** - Cantilever scope mount · One ¼" stock spacer

MAXUS®

	GA.	BARREL LENGTH	CODE NUMBER	UPC #	CHOKES INCLUDED	CHAMBER	*AVG. WEIGHT	OVERALL LENGTH	DROP AT COMB	DROP AT HEEL	LENGTH OF PULL	RATE OF TWIST	RIB WIDTH	SUGG. RETAIL
<b>MAXUS HUNTER</b>														
<b>NEW</b>	12	30"	011608303	023614065838	F, M, IC	3"	7 lbs. 1 oz.	51"	1¾"	2"	14¼"	—	¼"	\$1,419.99
<b>NEW</b>	12	28"	011608304	023614065845	F, M, IC	3"	7 lbs.	49"	1¾"	2"	14¼"	—	¼"	1,419.99
<b>NEW</b>	12	26"	011608305	023614065852	F, M, IC	3"	6 lbs. 15 oz.	47"	1¾"	2"	14¼"	—	¼"	1,419.99
<b>NEW</b>	12	30"	011608203	023614065920	F, M, IC	3½"	7 lbs. 1 oz.	51"	1¾"	2"	14¼"	—	¼"	1,559.99
<b>NEW</b>	12	28"	011608204	023614065913	F, M, IC	3½"	7 lbs.	49"	1¾"	2"	14¼"	—	¼"	1,559.99
<b>NEW</b>	12	26"	011608205	023614065906	F, M, IC	3½"	6 lbs. 15 oz.	47"	1¾"	2"	14¼"	—	¼"	1,559.99
<b>MAXUS ALL-PURPOSE MOSSY OAK BREAK-UP INFINITY</b>														
<b>NEW</b>	12	26"	011619205	023614071396	XF, F, M, IC	3½"	6 lbs. 15 oz.	47¾"	1¾"	2"	14¼"	—	¼"	\$1,599.99
<b>MAXUS RIFLED DEER MOSSY OAK BREAK-UP INFINITY</b>														
<b>NEW</b>	12	22"	011617321	023614071358	Rif. Bbl./Cant.	3"	7 lbs. 3 oz.	43¾"	1¾"	2"	14¼"	1 in 28"	—	\$1,509.99

VECTORPRO™



BACK-BORED TECHNOLOGY

POWER DRIVE G A S S Y S T E M

INFLEX TECHNOLOGY



**MAXUS RIFLED DEER STALKER** ▶ GAUGE: 12 | DURA-TOUCH® ARMOR COATING ON STOCK AND FOREARM

**NEW**

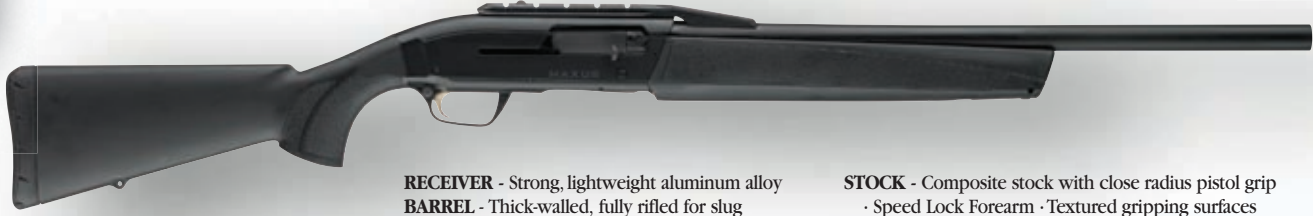

**DURA-TOUCH®**  
Armor Coating

**RECEIVER** - Strong, lightweight aluminum alloy  
**BARREL** - Thick-walled, fully rifled for slug ammunition only  
**ACTION** - Gas-operated autoloader · 3" chamber · Power Drive Gas System reduces recoil and cycles a wide range of loads

**STOCK** - Composite stock with close radius pistol grip · Speed Lock Forearm · Textured gripping surfaces · Shim adjustable for length of pull, cast and drop · Matte black finish · Dura-Touch® Armor Coating  
**FEATURES** - Cantilever scope mount · One ¼" stock spacer

**MAXUS SPORTING CARBON FIBER** ▶ GAUGE: 12 | DURA-TOUCH® ARMOR COATING ON STOCK AND FOREARM

**NEW**



**DURA-TOUCH®**  
Armor Coating

**RECEIVER** - Strong, lightweight aluminum alloy · Carbon fiber finish on top and bottom  
**BARREL** - Lightweight profile · Flat, ventilated rib · Carbon fiber finish  
**ACTION** - Gas-operated autoloader · 3" chamber · Power Drive Gas System reduces recoil and cycles a wide range of loads

**STOCK** - Composite stock with close radius pistol grip · Speed Lock Forearm · Textured gripping surfaces · Shim adjustable for length of pull, cast and drop · Carbon fiber finish · Dura-Touch® Armor Coating  
**FEATURES** - Vector Pro™ lengthened forcing cone · Five Invector-Plus™ choke tubes · Inflex Technology recoil pad · HiViz® Tri-Comp fiber-optic front sight · Ivory mid-bead sight · One ¼" stock spacer

**MAXUS SPORTING** ▶ GAUGE: 12 | GLOSS FINISH STOCK AND FOREARM

**NEW**

MAXUS



**RECEIVER** - Strong, lightweight aluminum alloy · Durable satin nickel finish · Laser engraving of game birds transforming into clay birds (quail on the right, mallard on the left)  
**BARREL** - Lightweight profile · Flat, ventilated rib

**ACTION** - Gas-operated autoloader · 3" chamber · Power Drive Gas System reduces recoil and cycles a wide range of loads  
**STOCK** - Gloss finish high grade walnut stock with close radius pistol grip · Speed Lock Forearm · Shim adjustable for length of pull, cast and drop  
**FEATURES** - Vector Pro™ lengthened forcing cone · Five Invector-Plus™ choke tubes · Inflex Technology recoil pad · HiViz® Tri-Comp fiber-optic front sight · Ivory mid-bead sight · One ¼" stock spacer

GA.	BARREL LENGTH	CODE NUMBER	UPC #	CHOKES INCLUDED	CHAMBER	*AVG. WEIGHT	OVERALL LENGTH	DROP AT COMB	DROP AT HEEL	LENGTH OF PULL	RATE OF TWIST	RIB WIDTH (TAPERED)	SUGG. RETAIL	
<b>MAXUS RIFLED DEER STALKER</b>														
<b>NEW</b>	12	22"	011620321	023614071792	Rif. Bbl./Cant.	3"	7 lbs. 3 oz.	51"	1¾"	2"	14¼"	1 in 28"	—	\$1,399.99
<b>MAXUS SPORTING CARBON FIBER</b>														
<b>NEW</b>	12	30"	011609303	023614068136	F, IM, M, IC, SK	3"	7 lbs.	51"	1¾"	2"	14¼"	—	8-6 mm	\$1,419.99
<b>NEW</b>	12	28"	011609304	023614068129	F, IM, M, IC, SK	3"	6 lbs. 15 oz.	51"	1¾"	2"	14¼"	—	8-6 mm	1,419.99
<b>MAXUS SPORTING</b>														
<b>NEW</b>	12	30"	011616303	023614071297	F, IM, M, IC, SK	3"	7 lbs. 1 oz.	51"	1¾"	2"	14¼"	—	8-6 mm	\$1,629.99
<b>NEW</b>	12	28"	011616304	023614071303	F, IM, M, IC, SK	3"	7 lbs.	51"	1¾"	2"	14¼"	—	8-6 mm	1,629.99

\*NOTE: Weights listed are approximate.

VECTORPRO



BACK-BORED TECHNOLOGY

POWER DRIVE SYSTEM

INFLEX TECHNOLOGY



**MAXUS STALKER** ▶ GAUGE: 12 | DURA-TOUCH® ARMOR COATING ON STOCK AND FOREARM



**DURA-TOUCH®**  
Armor Coating

**RECEIVER** - Strong, lightweight aluminum alloy  
**BARREL** - Lightweight profile · Flat, ventilated rib  
**ACTION** - Gas-operated autoloader · 3" and 3½" chamber models · Power Drive Gas System reduces recoil and cycles a wide range of loads

**STOCK** - Composite stock with close radius pistol grip · Speed Lock Forearm · Textured gripping surfaces · Shim adjustable for length of pull, cast and drop · Matte black finish · Dura-Touch® Armor Coating  
**FEATURES** - Vector Pro™ lengthened forcing cone · Three Invector-Plus™ choke tubes · Inflex Technology recoil pad · Ivory front bead sight · One ¼" stock spacer

**MAXUS, MOSSY OAK® DUCK BLIND®** ▶ GAUGE: 12 | DURA-TOUCH® ARMOR COATING ON STOCK AND FOREARM



**DURA-TOUCH®**  
Armor Coating

**RECEIVER** - Strong, lightweight aluminum alloy  
**BARREL** - Lightweight profile · Flat, ventilated rib  
**ACTION** - Gas-operated autoloader · 3" and 3½" chamber models · Power Drive Gas System reduces recoil and cycles a wide range of loads  
**STOCK** - Composite stock with close radius pistol grip · Speed Lock Forearm · Textured gripping surfaces · Shim adjustable for length of pull, cast and drop · Mossy Oak® Duck Blind® camo finish · Dura-Touch® Armor Coating  
**FEATURES** - Vector Pro™ lengthened forcing cone · Three Invector-Plus™ choke tubes · Inflex Technology recoil pad · Ivory front bead sight · One ¼" stock spacer

# MAXUS

GA.	BARREL LENGTH	CODE NUMBER	UPC#	CHOKES INCLUDED	CHAMBER	*AVG. WEIGHT	OVERALL LENGTH	DROP AT COMB	DROP AT HEEL	LENGTH OF PULL	RIB WIDTH	SUGG. RETAIL
<b>MAXUS STALKER</b>												
12	28"	011600304	023614259428	F, M, IC	3"	6 lbs. 15 oz.	49¼"	1¾"	2"	14¼"	¼"	\$1,199.99
12	26"	011600305	023614259435	F, M, IC	3"	6 lbs. 14 oz.	47¼"	1¾"	2"	14¼"	¼"	1,199.99
12	28"	011600204	023614259459	F, M, IC	3½"	6 lbs. 15 oz.	49¼"	1¾"	2"	14¼"	¼"	1,389.99
12	26"	011600205	023614259466	F, M, IC	3½"	6 lbs. 14 oz.	47¼"	1¾"	2"	14¼"	¼"	1,389.99
<b>MAXUS MOSSY OAK DUCK BLIND</b>												
12	28"	011601304	023614065944	F, M, IC	3"	6 lbs. 15 oz.	49¼"	1¾"	2"	14¼"	¼"	\$1,339.99
12	26"	011601305	023614065951	F, M, IC	3"	6 lbs. 14 oz.	47¼"	1¾"	2"	14¼"	¼"	1,339.99
12	28"	011601204	023614259480	F, M, IC	3½"	6 lbs. 15 oz.	49¼"	1¾"	2"	14¼"	¼"	1,539.99
12	26"	011601205	023614259497	F, M, IC	3½"	6 lbs. 14 oz.	47¼"	1¾"	2"	14¼"	¼"	1,539.99

\*NOTE: Weights listed are approximate.





# Citori

## EXCEEDING ITS REPUTATION.

There simply isn't another over and under made today

that can boast the reputation of a Browning Citori. Regarded by many as having the toughest action available, these gorgeous guns are precision built and hand assembled to outlast the competition. Quick to the shoulder and fast to swing, a Citori offers all of this quality and performance at a price tag often thousands less than other premium shotguns.

### STEEL SHOT PERFORMANCE



The strength of a Browning barrel is legendary, and built to handle the punishment of steel shot. Unlike some manufacturers' barrels that show pitting after shooting steel, Browning has pioneered construction that maximizes steel shot performance and barrel durability. Browning barrels meet the strictest material and construction quality standards. The barrel blanks are made from rolled and tempered steel bars and are stress relieved to offer exceptional mechanical properties. The barrel blanks are then precision drilled, reamed and honed to exacting specifications. With proper care, Browning Citori barrels will last a lifetime.



### TRIPLE TRIGGER SYSTEM

All Sporting Clays, XT and XS Series Citori shotguns come equipped with the Triple Trigger™ System, which fine-tunes the length of pull. Choose between a wide checkered, a narrow smooth and a wide smooth canted trigger shoe.



### LOCKING BOLT AND HINGE PIN

The Citori features a heavy-duty, transverse-mounted, full-width tapered locking bolt that engages a full-width tapered recess in the rear barrel lugs. Tapering the bolt and recess allows the bolt to seat deeper, accommodating for wear. The hinge pin extends across the width of the receiver for maximum strength. Engineering like this ensures the Citori wears in, not out.

### HAMMERS AND HAMMER EJECTORS

For positive primer ignition, Citori hammers are driven by powerful coil-type mainsprings. The convenient barrel selector allows a shooter to choose which barrel fires on the first pull of the single trigger, and the second pull fires the remaining barrel. Ejectors are fired by a sharp hammer blow for more positive ejection than the push imparted by competitors' ejectors. The automatic ejectors eject fired hulls when the breech is opened and elevate unfired shells for easy removal.





All Browning firearms are shipped with a free locking device to assist in the safe storage of firearms.



**TOTAL BARREL DYNAMICS**

**VECTOR PRO™ LENGTHENED FORCING CONES ON 12 AND 20 GAUGE CITORI SHOTGUNS**

**VECTORPRO™**

Back-boring reduces friction between the shot cup and the bore for increased shot pellet velocity, minimized pellet deformity for more uniform patterns and reduced felt recoil. Browning was the first manufacturer to put back-boring and its advantages into production shotguns. Now we've made the next big leap with Vector Pro. More than 2" longer than the competitors' forcing cone dimensions, Vector Pro's gradual taper minimizes shot deformation for maximum pattern uniformity, consistency and density and more shot right where it needs to be to bring down birds and smoke clays. Vector Pro back-bore specifications are the ideal bore diameters. Any larger and gases blow past the shot cup, resulting in reduced pellet velocity and blown shot patterns. If the bore is smaller, pellets are smashed into the forcing cone, leading to poor ballistic performance and uneven patterning.

**INVECTOR™ CHOKE TUBE SYSTEMS**

The proven Standard Invector (28 gauge, .410 bore) or Invector-Plus™ (12, 20 gauge) interchangeable choke tube systems are featured on every Citori shotgun and provide consistent, dense shot patterns in the constriction needed for the specific shooting situation. The longer choke taper inside an Invector-Plus choke tube works with Vector Pro™ lengthened forcing cones to produce dense patterns with uniform densities and fewer fliers. The superior designs of the Invector systems are far more durable than the choke systems found in competitors' guns, especially when shooting steel shot loads. The Invector systems eliminate gases slipping between the choke tube and barrel that could damage both the choke tube and the barrel.

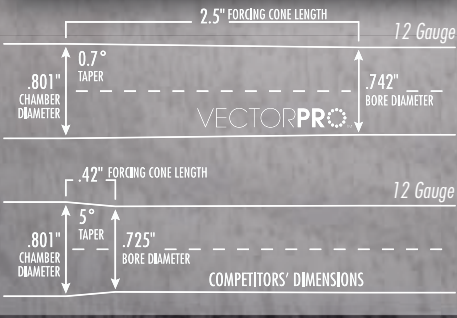
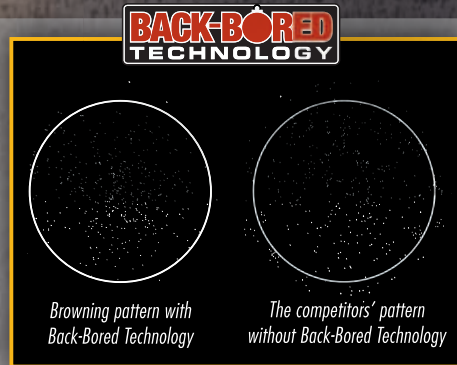

**CHROME CHAMBERS**

For increased durability and corrosion resistance, all Citori shotguns feature hard chrome-plated chambers to resist the toll that thousands of shells can take on lesser quality guns.

**CITORI SATIN HUNTER MICRO MIDAS ▶ GAUGE: 12 (SHOWN), 20 | SATIN FINISH STOCK AND FOREARM**

**NEW**



**RECEIVER** - Steel · Blued finish  
**BARREL** - Ventilated rib  
**ACTION** - Single selective trigger  
 · Hammer ejectors · Top-tang barrel selector/safety

**STOCK** - Satin finish walnut · Compact stock with 13" length of pull  
**FEATURES** - Vector Pro™ lengthened forcing cone  
 · Three Invector-Plus™ choke tubes · Recoil pad on 12 gauge model · Ivory front bead sight

	GA.	BARREL LENGTH	CODE NUMBER	UPC#	CHOKES INCLUDED	CHAMBER	*AVG. WEIGHT	OVERALL LENGTH	DROP AT COMB	DROP AT HEEL	LENGTH OF PULL	RIB WIDTH	SUGG. RETAIL
<b>NEW</b>	12	26"	013497305	023614071259	F, M, IC	3"	6 lbs. 11 oz.	41¾"	1½"	2½"	13"	⅝"	\$1,469.99
<b>NEW</b>	12	24"	013497306	023614071266	F, M, IC	3"	6 lbs. 9 oz.	39¾"	1½"	2½"	13"	⅝"	1,469.99
<b>NEW</b>	20	26"	013497605	023614071273	F, M, IC	3"	6 lbs. 4 oz.	41¾"	1½"	2¾"	13"	¼"	1,469.99
<b>NEW</b>	20	24"	013497606	023614071280	F, M, IC	3"	6 lbs. 2 oz.	39¾"	1½"	2¾"	13"	¼"	1,469.99

\*NOTE: Weights listed are approximate.



**CITORI WHITE LIGHTNING** ▶ GAUGE: 12, 20 (SHOWN), 28, .410 | GLOSS OIL FINISH STOCK AND FOREARM



VECTORPRO™



**RECEIVER** - Steel · Silver nitride finish · High-relief engraving  
**BARREL** - Ventilated rib

**ACTION** - Single selective trigger · Hammer ejectors  
 · Top-tang barrel selector/safety  
**STOCK** - Gloss oil finish Grade II/III walnut  
 · Lightning-style stock and forearm

**FEATURES** - Vector Pro™ lengthened forcing cones on 12 and 20 · Three Invector-Plus™ choke tubes on 12 and 20 · Three Standard Invector™ on 28 and .410 · Recoil pad on 12 gauge model · Ivory front bead sight

GA.	BARREL LENGTH	CODE NUMBER	UPC #	CHOKES INCLUDED	CHAMBER	*AVG. WEIGHT	OVERALL LENGTH	DROP AT COMB	DROP AT HEEL	LENGTH OF PULL	RIB WIDTH	SUGG. RETAIL
12	28"	013462304	023614067931	F, M, IC	3"	8 lbs. 2 oz.	45"	1½"	2½"	14¼"	⅝"	\$1,959.99
12	26"	013462305	023614067924	F, M, IC	3"	8 lbs.	43"	1½"	2½"	14¼"	⅝"	1,959.99
20	28"	013462604	023614067955	F, M, IC	3"	6 lbs. 9 oz.	45"	1½"	2¾"	14¼"	¼"	1,959.99
20	26"	013462605	023614067948	F, M, IC	3"	6 lbs. 7 oz.	43"	1½"	2¾"	14¼"	¼"	1,959.99
28	28"	013462813	023614067979	F, M, IC	2¾"	6 lbs. 12 oz.	45"	1½"	2¾"	14¼"	¼"	2,029.99
28	26"	013462814	023614067962	F, M, IC	2¾"	6 lbs. 10 oz.	43"	1½"	2¾"	14¼"	¼"	2,029.99
.410	28"	013462913	023614067993	F, M, IC	3"	6 lbs. 10 oz.	45"	1½"	2¾"	14¼"	¼"	2,029.99
.410	26"	013462914	023614067986	F, M, IC	3"	6 lbs. 8 oz.	43"	1½"	2¾"	14¼"	¼"	2,029.99

\*NOTE: Weights listed are approximate.

**CITORI LIGHTNING** ▶ GAUGE: 12, 20 (SHOWN), 28, .410 | GLOSS FINISH STOCK AND FOREARM



Citori Lightning, Left

Citori Lightning, Right

**RECEIVER** - Steel · Blued finish · High-relief engraving  
**BARREL** - Ventilated rib  
**ACTION** - Single selective trigger · Hammer ejectors · Top-tang barrel selector/safety

**STOCK** - Gloss finish walnut · Lightning-style stock and forearm  
**FEATURES** - Vector Pro™ lengthened forcing cones on 12 and 20 · Three Invector-Plus™ choke tubes on 12 and 20 · Three Standard Invector™ on 28 and .410 · Recoil pad on 12 gauge model (see Grade IV and VII models on page 19) · Ivory front bead sight

VECTORPRO™



GA.	BARREL LENGTH	CODE NUMBER	UPC #	CHOKES INCLUDED	CHAMBER	*AVG. WEIGHT	OVERALL LENGTH	DROP AT COMB	DROP AT HEEL	LENGTH OF PULL	RIB WIDTH	SUGG. RETAIL
12	28"	013461304	023614067856	F, M, IC	3"	8 lbs. 2 oz.	45"	1½"	2½"	14¼"	⅝"	\$1,899.99
12	26"	013461305	023614067849	F, M, IC	3"	8 lbs.	43"	1½"	2½"	14¼"	⅝"	1,899.99
20	28"	013461604	023614067870	F, M, IC	3"	6 lbs. 9 oz.	45"	1½"	2¾"	14¼"	¼"	1,899.99
20	26"	013461605	023614067863	F, M, IC	3"	6 lbs. 7 oz.	43"	1½"	2¾"	14¼"	¼"	1,899.99
28	28"	013461813	023614067894	F, M, IC	2¾"	6 lbs. 12 oz.	45"	1½"	2¾"	14¼"	¼"	1,959.99
28	26"	013461814	023614067887	F, M, IC	2¾"	6 lbs. 10 oz.	43"	1½"	2¾"	14¼"	¼"	1,959.99
.410	28"	013461913	023614067917	F, M, IC	3"	6 lbs. 10 oz.	45"	1½"	2¾"	14¼"	¼"	1,959.99
.410	26"	013461914	023614067900	F, M, IC	3"	6 lbs. 8 oz.	43"	1½"	2¾"	14¼"	¼"	1,959.99

\*NOTE: Weights listed are approximate.



**CITORI 625 FEATHER** ▶ GAUGE: 12 (SHOWN), 20, 28, .410 | GLOSS OIL FINISH STOCK AND FOREARM



VECTORPRO



**RECEIVER** - Lightweight alloy with steel breech face and hinge pin · High-relief engraving  
**BARREL** - Lightweight profile · Ventilated rib  
**ACTION** - Single selective trigger · Hammer ejectors · Top-tang barrel selector/safety

**STOCK** - Gloss oil finish Grade II/III walnut stock with close radius pistol grip · Schnabel forearm  
**FEATURES** - Vector Pro™ lengthened forcing cones on 12 and 20 · Three Invector-Plus™ choke tubes on 12 and 20 · Three Standard Invector™ on 28 and .410 · Recoil pad on 12 gauge model · Ivory front bead sight



Citori 625 Feather 12 Gauge, Left    Citori 625 Feather 12 Gauge, Right    Citori 625 Feather Small Gauge, Left    Citori 625 Feather Small Gauge, Right

GA.	BARREL LENGTH	CODE NUMBER	UPC #	CHOKES INCLUDED	CHAMBER	*AVG. WEIGHT	OVERALL LENGTH	DROP AT COMB	DROP AT HEEL	LENGTH OF PULL	RIB WIDTH	SUGG. RETAIL
12	28"	013427304	023614065289	F, M, IC	3"	7 lbs.	45"	1 3/8"	2 1/2"	14 1/4"	5/16"	\$2,679.99
12	26"	013427305	023614065272	F, M, IC	3"	6 lbs. 14 oz.	43"	1 3/8"	2 1/2"	14 1/4"	5/16"	2,679.99
20	28"	013427604	023614065302	F, M, IC	3"	5 lbs. 8 oz.	45"	1 1/2"	2 3/8"	14 1/4"	1/4"	2,679.99
20	26"	013427605	023614065296	F, M, IC	3"	5 lbs. 6 oz.	43"	1 1/2"	2 3/8"	14 1/4"	1/4"	2,679.99
28	28"	013427813	023614065326	F, M, IC	2 3/4"	5 lbs. 11 oz.	45"	1 1/2"	2 3/8"	14 1/4"	1/4"	2,709.99
28	26"	013427814	023614065319	F, M, IC	2 3/4"	5 lbs. 9 oz.	43"	1 1/2"	2 3/8"	14 1/4"	1/4"	2,709.99
.410	28"	013427913	023614065340	F, M, IC	3"	5 lbs. 13 oz.	45"	1 1/2"	2 3/8"	14 1/4"	1/4"	2,709.99
.410	26"	013427914	023614065333	F, M, IC	3"	5 lbs. 11 oz.	43"	1 1/2"	2 3/8"	14 1/4"	1/4"	2,709.99

\*NOTE: Weights listed are approximate.

**CITORI 625 FIELD** ▶ GAUGE: 12 (SHOWN), 20, 28, .410 | GLOSS OIL FINISH STOCK AND FOREARM



VECTORPRO



**RECEIVER** - Steel · Silver nitride finish · High-relief engraving  
**BARREL** - Lightweight profile · Ventilated rib  
**ACTION** - Single selective trigger · Hammer ejectors · Top-tang barrel selector/safety

**STOCK** - Gloss oil finish Grade II/III walnut stock with close radius pistol grip · Schnabel forearm  
**FEATURES** - Vector Pro™ lengthened forcing cones on 12 and 20 · Three Invector-Plus™ choke tubes on 12 and 20 · Three Standard Invector™ on 28 and .410 · Recoil pad on 12 gauge model · Ivory front bead sight



Citori 625 Field 12 Gauge, Left    Citori 625 Field 12 Gauge, Right    Citori 625 Field Small Gauge, Left    Citori 625 Field Small Gauge, Right

GA.	BARREL LENGTH	CODE NUMBER	UPC #	CHOKES INCLUDED	CHAMBER	*AVG. WEIGHT	OVERALL LENGTH	DROP AT COMB	DROP AT HEEL	LENGTH OF PULL	RIB WIDTH	SUGG. RETAIL
12	28"	013356304	023614255185	F, M, IC	3"	7 lbs. 14 oz.	45"	1 3/8"	2 1/2"	14 1/4"	5/16"	\$2,499.99
12	26"	013356305	023614255178	F, M, IC	3"	7 lbs. 12 oz.	43"	1 3/8"	2 1/2"	14 1/4"	5/16"	2,499.99
20	28"	013356604	023614065456	F, M, IC	3"	6 lbs. 9 oz.	45"	1 1/2"	2 3/8"	14 1/4"	1/4"	2,499.99
20	26"	013356605	023614065449	F, M, IC	3"	6 lbs. 7 oz.	43"	1 1/2"	2 3/8"	14 1/4"	1/4"	2,499.99
28	28"	013356813	023614065470	F, M, IC	2 3/4"	6 lbs. 13 oz.	45"	1 1/2"	2 3/8"	14 1/4"	1/4"	2,519.99
28	26"	013356814	023614065463	F, M, IC	2 3/4"	6 lbs. 11 oz.	43"	1 1/2"	2 3/8"	14 1/4"	1/4"	2,519.99
.410	28"	013356913	023614065494	F, M, IC	3"	6 lbs. 14 oz.	45"	1 1/2"	2 3/8"	14 1/4"	1/4"	2,519.99
.410	26"	013356914	023614065487	F, M, IC	3"	6 lbs. 12 oz.	43"	1 1/2"	2 3/8"	14 1/4"	1/4"	2,519.99

\*NOTE: Weights listed are approximate.





**CITORI SUPERLIGHT FEATHER** ▶ GAUGE: 12, 20 (SHOWN) | GLOSS FINISH STOCK AND FOREARM



VECTORPRO™



**RECEIVER** - Lightweight alloy with steel breech face and hinge pin  
 · High-relief engraving  
**BARREL** - Ventilated rib  
**ACTION** - Single selective trigger  
 · Hammer ejectors · Top-tang barrel selector/safety

**STOCK** - Gloss finish walnut  
 · English-style straight grip stock  
 · Schnabel forearm  
**FEATURES** - Vector Pro™ lengthened forcing cones on 12 and 20 · Three Invector-Plus™ choke tubes · Ivory front bead sight

**CITORI LIGHTNING FEATHER COMBO** ▶ GAUGE: 20, 28 | GLOSS FINISH STOCK AND FOREARM

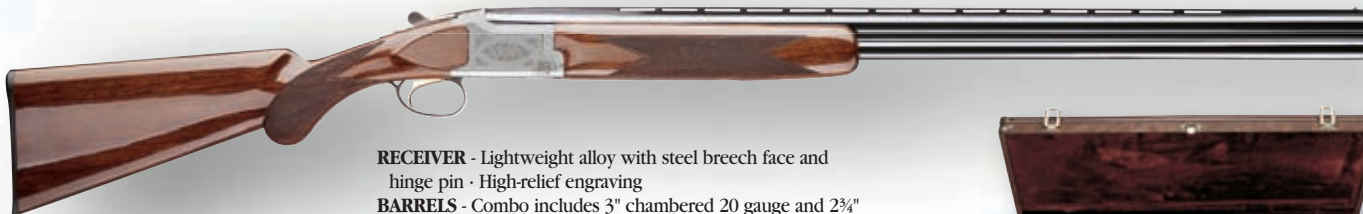

VECTORPRO™



**RECEIVER** - Lightweight alloy with steel breech face and hinge pin · High-relief engraving  
**BARRELS** - Combo includes 3" chambered 20 gauge and 2¾" chambered 28 gauge barrels in 27" length · Ventilated rib  
**ACTION** - Single selective trigger · Hammer ejectors  
 · Top-tang barrel selector/safety  
**STOCK** - Gloss finish walnut · Lightning-style stock and forearm  
**FEATURES** - Vector Pro™ lengthened forcing cones on 20 gauge barrels  
 · Three Invector-Plus™ 20 gauge choke tubes · Three Standard Invector™ 28 gauge choke tubes · Ivory front bead sight · Fitted luggage case included



**CITORI 625 SPORTING** ▶ GAUGE: 12 (SHOWN), 20, 28, .410 | GLOSS OIL FINISH STOCK AND FOREARM



VECTORPRO™



**RECEIVER** - Steel · Silver nitride finish · High-relief engraving with gold embellishment  
**BARREL** - Ventilated top and side rib  
 · Tapered, floating top rib · Ported on 12 and 20  
**ACTION** - Single selective trigger  
 · Hammer ejectors · Top-tang barrel selector/safety

**STOCK** - Gloss oil finish Grade III/IV walnut stock with close radius pistol grip and right-hand palm swell  
 · Schnabel forearm

**FEATURES** - Vector Pro™ lengthened forcing cones on 12 and 20 · Five Diamond Grade extended Invector-Plus™ choke tubes on 12 and 20 · Standard Invector™ on 28 and .410 · Sporting recoil pad · Triple Trigger™ System · HiViz® Pro-Comp fiber-optic sight



Citori 625 Sporting, Bottom

Citori 625 Sporting, Right



**CITORI XS SPECIAL WITH LOW POST RIB AND ADJUSTABLE COMB** ▶ GAUGE: 12 | SATIN FINISH STOCK AND FOREARM

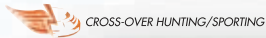

VECTORPRO



**RECEIVER** - Steel · Silver nitride finish · Gold accented, high-relief XS Special engraving  
**BARREL** - Lightweight profile · Ventilated top and side ribs · Tapered, floating low-post top rib · Ported  
**ACTION** - Single selective trigger · Hammer ejectors · Top-tang barrel selector/safety

**STOCK** - Satin finish walnut stock with right-hand palm swell · Adjustable comb · Semi-beavertail forearm with finger grooves · Ideal for skeet and sporting clays  
**FEATURES** - Vector Pro™ lengthened forcing cones · Five Invector-Plus™ Midas™ Grade choke tubes · Triple Trigger™ System · HiViz® Pro-Comp fiber-optic sight

**ENGINEERED FOR YEARS OF PERFORMANCE.**

High-quality fit and finish make the Citori one of the most durable, long-lasting guns you can own. When you open the breech of a Citori, the quality is evident. Precision manufacturing and hand-fitting ensures enduring quality and smoothness. Timeless, elegant and rugged, the Citori remains the quintessential over and under shotgun.

**CITORI XS SPECIAL WITH HIGH POST RIB AND ADJUSTABLE COMB** ▶ GAUGE: 12 | SATIN FINISH STOCK AND FOREARM



VECTORPRO



**RECEIVER** - Steel · Silver nitride finish · Gold accented, high-relief XS Special engraving  
**BARREL** - Lightweight profile · Ventilated top and side ribs · Tapered, floating high-post top rib · Ported  
**ACTION** - Single selective trigger · Hammer ejectors · Top-tang barrel selector/safety

**STOCK** - Satin finish walnut stock with right-hand palm swell · Adjustable comb · Semi-beavertail forearm with finger grooves · Ideal for skeet and sporting clays  
**FEATURES** - Vector Pro™ lengthened forcing cones · Five Invector-Plus™ Midas™ Grade choke tubes · Triple Trigger™ System · HiViz® Pro-Comp fiber-optic sight

GA.	BARREL LENGTH	CODE NUMBER	UPC #	CHOKES INCLUDED	CHAMBER	*AVG. WEIGHT	OVERALL LENGTH	DROP AT COMB	DROP AT HEEL	LENGTH OF PULL	RIB WIDTH (TAPERED)	SUGG. RETAIL
<b>CITORI SUPERLIGHT FEATHER</b>												
12	26"	013055405	023614232346	F, M, IC	2¾"	6 lbs. 4 oz.	43"	1½"	2½"	14¼"	¼"	\$2,389.99
20	26"	013055705	023614238904	F, M, IC	2¾"	5 lbs. 11 oz.	43"	1½"	2½"	14¼"	⅜"	2,389.99
<b>CITORI LIGHTNING FEATHER COMBO</b>												
20   28	27"	013064735	023614234272	F, M, IC	3" & 2¾"	6 lbs. 3 oz.	44"	1½"	2½"	14¼"	¼"	\$3,819.99
<b>CITORI 625 SPORTING (SHOWN)</b>												
12	32"	013355426	023614255161	F, IM, M, IC, SK	2¾"	8 lbs. 2 oz.	50½"	1⅞"	2½"	14¾"	(⅞" - 7/16")	\$3,559.99
12	30"	013355427	023614255154	F, IM, M, IC, SK	2¾"	8 lbs.	48½"	1⅞"	2½"	14¾"	(⅞" - 7/16")	3,559.99
12	28"	013355428	023614255147	F, IM, M, IC, SK	2¾"	7 lbs. 14 oz.	46½"	1⅞"	2½"	14¾"	(⅞" - 7/16")	3,559.99
20	32"	013355726	023614065371	F, IM, M, IC, SK	2¾"	7 lbs. 3 oz.	49½"	1⅞"	2⅜"	14¾"	⅜"	3,559.99
20	30"	013355727	023614065364	F, IM, M, IC, SK	2¾"	7 lbs. 1 oz.	47½"	1⅞"	2⅜"	14¾"	⅜"	3,559.99
20	28"	013355728	023614065357	F, IM, M, IC, SK	2¾"	6 lbs. 15 oz.	45½"	1⅞"	2⅜"	14¾"	⅜"	3,559.99
28	32"	013355811	023614065401	F, IM, M, IC, SK	2¾"	7 lbs. 6 oz.	49½"	1⅞"	2⅜"	14¾"	⅜"	3,579.99
28	30"	013355812	023614065395	F, IM, M, IC, SK	2¾"	7 lbs. 4 oz.	47½"	1⅞"	2⅜"	14¾"	⅜"	3,579.99
28	28"	013355813	023614065388	F, IM, M, IC, SK	2¾"	7 lbs. 2 oz.	45½"	1⅞"	2⅜"	14¾"	⅜"	3,579.99
410	32"	013355911	023614065432	F, IM, M, IC, SK	3"	7 lbs. 7 oz.	49½"	1⅞"	2⅜"	14¾"	⅜"	3,579.99
410	30"	013355912	023614065425	F, IM, M, IC, SK	3"	7 lbs. 5 oz.	47½"	1⅞"	2⅜"	14¾"	⅜"	3,579.99
410	28"	013355913	023614065418	F, IM, M, IC, SK	3"	7 lbs. 3 oz.	45½"	1⅞"	2⅜"	14¾"	⅜"	3,579.99
<b>CITORI 625 SPORTING WITH ADJUSTABLE COMB</b>												
12	32"	013399426	023614258889	F, IM, M, IC, SK	2¾"	8 lbs. 9 oz.	50⅞"	1¾" Adj.	2½" Adj.	14¾"	(⅞" - 7/16")	\$3,959.99
12	30"	013399427	023614258872	F, IM, M, IC, SK	2¾"	8 lbs. 7 oz.	48⅞"	1¾" Adj.	2½" Adj.	14¾"	(⅞" - 7/16")	3,959.99
12	28"	013399428	023614258865	F, IM, M, IC, SK	2¾"	8 lbs. 5 oz.	46⅞"	1¾" Adj.	2½" Adj.	14¾"	(⅞" - 7/16")	3,959.99
<b>CITORI XS SPECIAL WITH LOW POST RIB AND ADJUSTABLE COMB</b>												
12	32"	013128426	023614245780	IM, M, IC, SK, C	2¾"	8 lbs. 12 oz.	49¾"	1⅞" Adj.	1⅞" Adj.	14¾"	(⅞" - 7/16")	\$3,459.99
12	30"	013128427	023614245803	IM, M, IC, SK, C	2¾"	8 lbs. 10 oz.	47¾"	1⅞" Adj.	1⅞" Adj.	14¾"	(⅞" - 7/16")	3,459.99
<b>CITORI XS SPECIAL WITH HIGH POST RIB AND ADJUSTABLE COMB</b>												
12	32"	013175426	023614255833	IM, M, IC, SK, C	2¾"	8 lbs. 12 oz.	49¾"	1⅞" Adj.	1⅞" Adj.	14¾"	(⅞" - 7/16")	\$3,459.99
12	30"	013175427	023614255826	IM, M, IC, SK, C	2¾"	8 lbs. 10 oz.	47¾"	1⅞" Adj.	1⅞" Adj.	14¾"	(⅞" - 7/16")	3,459.99

\*NOTE: Weights listed are approximate.



**CITORI XS SKEET** ▶ GAUGE: 12 (SHOWN), 20 | SATIN FINISH STOCK AND FOREARM



VECTORPRO



BACK-BORED TECHNOLOGY

**RECEIVER** - Steel · Silver nitride finish  
· Gold accented, high-relief engraving  
**BARREL** - Lightweight profile · Ventilated top and side ribs · Tapered, floating high-post top rib · Ported  
**ACTION** - Single selective trigger  
· Hammer ejectors · Top-tang barrel selector/safety

**STOCK** - Satin finish Grade III/IV walnut stock with right-hand palm swell · Semi-beavertail forearm with finger grooves  
**FEATURES** - Vector Pro™ lengthened forcing cones · Three Invector-Plus™ choke tubes · Triple Trigger™ System · HiViz® Pro-Comp fiber-optic sight · Adjustable comb optional

**CITORI XT TRAP GOLD WITH ADJUSTABLE COMB** ▶ GAUGE: 12 | GLOSS FINISH STOCK AND FOREARM

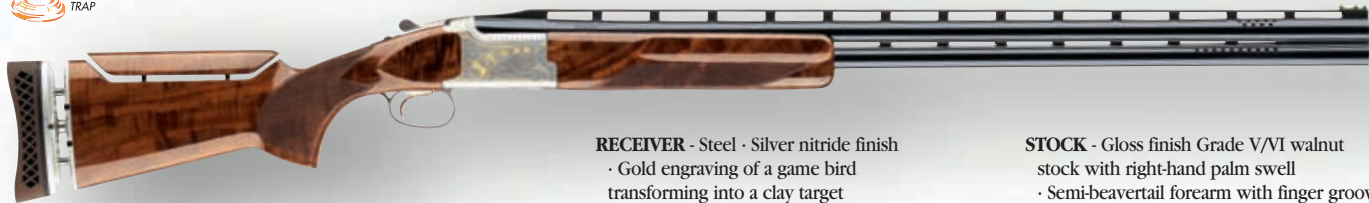

VECTORPRO



BACK-BORED TECHNOLOGY

**RECEIVER** - Steel · Silver nitride finish  
· Gold engraving of a game bird transforming into a clay target  
**BARREL** - Ventilated top and side ribs · Tapered, floating high-post top rib · Ported  
**ACTION** - Single selective trigger · Hammer ejectors · Top-tang barrel selector/safety

**STOCK** - Gloss finish Grade V/VI walnut stock with right-hand palm swell · Semi-beavertail forearm with finger grooves  
**FEATURES** - Vector Pro™ lengthened forcing cones · Three Invector-Plus™ choke tubes · Triple Trigger™ System · HiViz® Pro-Comp sight · Adjustable straight comb · Adjustable GraCoil® recoil reduction system

**CITORI XT TRAP** ▶ GAUGE: 12 | GLOSS FINISH STOCK AND FOREARM



VECTORPRO



BACK-BORED TECHNOLOGY

**RECEIVER** - Steel · Silver nitride finish  
· Gold accented, high-relief engraving  
**BARREL** - Ventilated top and side ribs · Tapered, floating high-post top rib · Ported  
**ACTION** - Single selective trigger · Hammer ejectors · Top-tang barrel selector/safety

**STOCK** - Gloss finish Grade III/IV walnut stock with right-hand palm swell · Semi-beavertail forearm with finger grooves  
**FEATURES** - Vector Pro™ lengthened forcing cones · Three Invector-Plus™ choke tubes · Triple Trigger™ System · HiViz® Pro-Comp sight · Adjustable straight comb optional

GA.	BARREL LENGTH	CODE NUMBER	UPC #	CHOKES INCLUDED	CHAMBER	*AVG. WEIGHT	OVERALL LENGTH	DROP AT COMB	DROP AT HEEL	LENGTH OF PULL	TRIB WIDTH (TAPERED)	SUGG. RETAIL
<b>CITORI XS SKEET</b>												
12	30"	013065427	023614234241	SK, SK, IC	2¾"	7 lbs. 15 oz.	47½"	1¾"	1¾"	14¾"	¾"	\$3,029.99
12	28"	013065428	023614234258	SK, SK, IC	2¾"	7 lbs. 13 oz.	45½"	1¾"	1¾"	14¾"	¾"	3,029.99
20	30"	013065727	023614236863	SK, SK, IC	2¾"	7 lbs. 4 oz.	47½"	1¾"	1¾"	14¾"	¾"	3,029.99
20	28"	013065728	023614236870	SK, SK, IC	2¾"	7 lbs. 2 oz.	45½"	1¾"	1¾"	14¾"	¾"	3,029.99
<b>CITORI XS SKEET WITH ADJUSTABLE COMB (SHOWN)</b>												
12	30"	013066427	023614234296	SK, SK, IC	2¾"	8 lbs. 4 oz.	47½"	1⅞" Adj.	1⅞" Adj.	14¾"	¾"	\$3,429.99
12	28"	013066428	023614234302	SK, SK, IC	2¾"	8 lbs. 2 oz.	45½"	1⅞" Adj.	1⅞" Adj.	14¾"	¾"	3,429.99
20	30"	013066727	023614236887	SK, SK, IC	2¾"	7 lbs. 9 oz.	47½"	1⅞" Adj.	1⅞" Adj.	14¾"	¾"	3,429.99
20	28"	013066728	023614236894	SK, SK, IC	2¾"	7 lbs. 7 oz.	45½"	1⅞" Adj.	1⅞" Adj.	14¾"	¾"	3,429.99
<b>CITORI XT TRAP GOLD WITH ADJUSTABLE COMB</b>												
12	32"	013228426	023614249344	F, F, IM	2¾"	9 lbs. 2 oz.	49"	1⅞" Adj.	1⅞" Adj.	14¾"	(¼" - ¾")	\$5,439.99
12	30"	013228427	023614249337	F, F, IM	2¾"	9 lbs.	47"	1⅞" Adj.	1⅞" Adj.	14¾"	(¼" - ¾")	5,439.99
<b>CITORI XT TRAP (SHOWN)</b>												
12	32"	013058426	023614232865	F, F, IM	2¾"	8 lbs. 8 oz.	49"	1⅞"	2"	14¾"	(¼" - ¾")	\$2,819.99
12	30"	013058427	023614232858	F, F, IM	2¾"	8 lbs. 6 oz.	47"	1⅞"	2"	14¾"	(¼" - ¾")	2,819.99
<b>CITORI XT TRAP WITH ADJUSTABLE COMB</b>												
12	32"	013057426	023614232391	F, F, IM	2¾"	8 lbs. 13 oz.	49"	1⅞" Adj.	1⅞" Adj.	14¾"	(¼" - ¾")	\$3,229.99
12	30"	013057427	023614232384	F, F, IM	2¾"	8 lbs. 11 oz.	47"	1⅞" Adj.	1⅞" Adj.	14¾"	(¼" - ¾")	3,229.99

\*NOTE: Weights listed are approximate.



**CITORI GRADE IV LIGHTNING** ▶ GAUGE: 12 (SHOWN), 20, 28, .410 | GLOSS FINISH STOCK AND FOREARM



**RECEIVER** - Steel · Grayed finish · Full coverage high-relief engraving includes the trigger guard and tang screws (12 gauge models illustrate pheasants on the right, mallards on the left. 20, 28 gauge and .410 bore models feature quail and grouse.)  
**BARREL** - Ventilated rib

**ACTION** - Single selective trigger  
 · Hammer ejectors · Top-tang barrel selector/safety  
**STOCK** - Gloss finish Grade III/IV walnut  
 · Lightning-style stock and forearm  
**FEATURES** - Vector Pro™ lengthened forcing cones on 12 and 20 · Three Invector-Plus™ choke tubes on 12 and 20 · Three Standard Invector™ on 28 and .410 · Recoil pad on 12 gauge model · Ivory front bead sight



Grade IV 12 Gauge, Left

Grade IV 12 Gauge, Right



Grade IV 20 & 28 Ga., .410, Left

Grade IV 20 & 28 Ga., .410, Right

**CITORI GRADE VII LIGHTNING** ▶ GAUGE: 12, 20 (SHOWN), 28, .410 | GLOSS FINISH STOCK AND FOREARM



**RECEIVER** - Steel · Blued and grayed finishes available · Full coverage high-relief engraving is gold enhanced and includes the trigger guard, top-tang, forearm takedown lever and bracket (12 gauge models depict two flushing ringnecks and a pointer on the right side and three mallard drakes on the left side. 20, 28 gauge and .410 bore models feature quail and grouse.)

**BARREL** - Ventilated rib  
**ACTION** - Single selective trigger  
 · Hammer ejectors · Top-tang barrel selector/safety  
**STOCK** - Gloss finish Grade V/VI walnut  
 · Lightning-style stock and forearm  
**FEATURES** - Vector Pro™ lengthened forcing cones on 12 and 20 · Three Invector-Plus™ choke tubes on 12 and 20 · Three Standard Invector™ on 28 and .410 · Recoil pad on 12 gauge model · Ivory front bead sight



Grade VII 12 Gauge, Grayed (L)

Grade VII 12 Gauge, Grayed (R)



Gr. VII 20 & 28 Ga., .410, Grayed (L)

Gr. VII 20 & 28 Ga., .410, Grayed (R)

GA.	BARREL LENGTH	CODE NUMBER	UPC #	CHOKES INCLUDED	CHAMBER	*AVG. WEIGHT	OVERALL LENGTH	DROP AT COMB	DROP AT HEEL	LENGTH OF PULL	RIB WIDTH	SUGG. RETAIL	
<b>CITORI GRADE IV LIGHTNING</b>													
12	28"	013229304	023614249382	F, M, IC	3"	8 lbs. 3 oz.	45"	1½"	2½"	14¼"	⅝"	\$3,339.99	
12	26"	013229305	023614249375	F, M, IC	3"	8 lbs. 1 oz.	43"	1½"	2½"	14¼"	⅝"	3,339.99	
20	28"	013229604	023614249405	F, M, IC	3"	6 lbs. 12 oz.	45"	1½"	2¾"	14¼"	¼"	3,339.99	
20	26"	013229605	023614249399	F, M, IC	3"	6 lbs. 10 oz.	43"	1½"	2¾"	14¼"	¼"	3,339.99	
28	28"	013229813	023614249429	F, M, IC	2¾"	6 lbs. 10 oz.	45"	1½"	2¾"	14¼"	¼"	3,419.99	
28	26"	013229814	023614249412	F, M, IC	2¾"	6 lbs. 8 oz.	43"	1½"	2¾"	14¼"	¼"	3,419.99	
.410	28"	013229913	023614249443	F, M, IC	3"	6 lbs. 10 oz.	45"	1½"	2¾"	14¼"	¼"	3,419.99	
.410	26"	013229914	023614249436	F, M, IC	3"	6 lbs. 8 oz.	43"	1½"	2¾"	14¼"	¼"	3,419.99	
<b>CITORI GRADE VII LIGHTNING</b>													
Blued	12	28"	013302304	023614249467	F, M, IC	3"	8 lbs. 3 oz.	45"	1½"	2½"	14¼"	⅝"	\$5,299.99
Blued	12	26"	013302305	023614249450	F, M, IC	3"	8 lbs. 1 oz.	43"	1½"	2½"	14¼"	⅝"	5,299.99
Grayed	12	28"	013308304	023614249542	F, M, IC	3"	8 lbs. 3 oz.	45"	1½"	2½"	14¼"	⅝"	5,299.99
Grayed	12	26"	013308305	023614249535	F, M, IC	3"	8 lbs. 1 oz.	43"	1½"	2½"	14¼"	⅝"	5,299.99
Blued	20	28"	013302604	023614249481	F, M, IC	3"	6 lbs. 12 oz.	45"	1½"	2¾"	14¼"	¼"	5,299.99
Blued	20	26"	013302605	023614249474	F, M, IC	3"	6 lbs. 10 oz.	43"	1½"	2¾"	14¼"	¼"	5,299.99
Grayed	20	28"	013308604	023614249566	F, M, IC	3"	6 lbs. 12 oz.	45"	1½"	2¾"	14¼"	¼"	5,299.99
Grayed	20	26"	013308605	023614249559	F, M, IC	3"	6 lbs. 10 oz.	43"	1½"	2¾"	14¼"	¼"	5,299.99
Blued	28	28"	013302813	023614249504	F, M, IC	2¾"	6 lbs. 9 oz.	45"	1½"	2¾"	14¼"	¼"	5,379.99
Blued	28	26"	013302814	023614249498	F, M, IC	2¾"	6 lbs. 7 oz.	43"	1½"	2¾"	14¼"	¼"	5,379.99
Grayed	28	28"	013308813	023614249580	F, M, IC	2¾"	6 lbs. 9 oz.	45"	1½"	2¾"	14¼"	¼"	5,379.99
Grayed	28	26"	013308814	023614249573	F, M, IC	2¾"	6 lbs. 7 oz.	43"	1½"	2¾"	14¼"	¼"	5,379.99
Blued	.410	28"	013302913	023614249528	F, M, IC	3"	6 lbs. 10 oz.	45"	1½"	2¾"	14¼"	¼"	5,379.99
Blued	.410	26"	013302914	023614249511	F, M, IC	3"	6 lbs. 8 oz.	43"	1½"	2¾"	14¼"	¼"	5,379.99
Grayed	.410	28"	013308913	023614249603	F, M, IC	3"	6 lbs. 10 oz.	45"	1½"	2¾"	14¼"	¼"	5,379.99
Grayed	.410	26"	013308914	023614249597	F, M, IC	3"	6 lbs. 8 oz.	43"	1½"	2¾"	14¼"	¼"	5,379.99

\*NOTE: Weights listed are approximate.



# CYNERGY®

## A TOTALLY NEW EXPERIENCE IN OVER AND UNDER SHOTGUNS.

Unlike other “new” over and under shotguns, the innovative Browning Cynergy is not just a twist on old technology. The Cynergy is a completely new experience in over and under shotguns, with handling, felt recoil control, speed and reliability that you must shoot to fully appreciate.

### INFLEX TECHNOLOGY RECOIL PAD

The Inflex Technology Recoil Pad system provides long travel recoil reduction for a massive 25% decrease in felt recoil on 12 gauge guns and makes recoil virtually non-existent on small gauge guns. A slick Parylene coating prevents the pad from snagging on clothing and allows the recoil pad to remain soft. Three pad lengths are available in ½" increments to provide length of pull adjustment to fit a wide variety of shooters. A ¼" spacer is included for customizing. See page 27 for accessories. (Inflex not available on Cynergy Classics.)

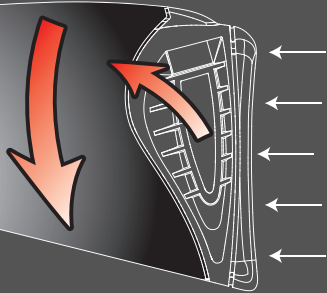

**INFLEX**  
TECHNOLOGY

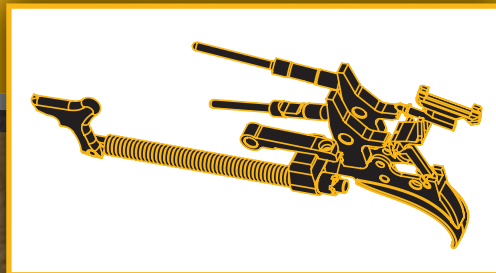

### MECHANICAL TRIGGER

Cynergy shotguns feature the innovative Reverse Striker ignition system, a striker-based, mechanical trigger that offers the benefits of a crisp feel, reduced locktime and less overtravel than any other over and under available. And because inertia is not needed for the hammers to set, the design eliminates the possibility of the second barrel not firing. Cynergy target models are equipped with the Triple Trigger™ System, allowing you to adjust the length of pull and switch between styles of trigger shoes: Wide checkered, narrow smooth and wide smooth canted.



### ADJUSTABLE COMB

Composite models include an integrated, adjustable comb system that allows the gun to be easily customized to your individual needs. Drop at comb adjustments are made in ⅛" increments. For cast on/cast off customizing, accessory combs are available.

*All Browning firearms are shipped with a free locking device to assist in the safe storage of firearms.*







### SUPERIOR GRIPPING SURFACES

Composite Cynergy models combine molded-in rubberized textured gripping surfaces and our proven Dura-Touch® Armor Coating for a sure hold and a sleek feel in all climate and weather conditions.



**MONOLOCK HINGE** The strong MonoLock Hinge design is the engineering behind the Cynergy's low profile receiver. The MonoLock Hinge is the integration of the monobloc and the hinge, and has up to 300% more surface area to pivot on than traditional trunnion-style hinges. Rectangular locking pins provide extra strength and feature a "Wear-In Relief" that keeps the action tight. Jeweling adds a beautiful appearance, smoother function and improved durability.

### VECTOR PRO™ LENGTHENED FORCING CONES ON 12 AND 20 GAUGE CYNERGY SHOTGUNS

Back-boring reduces friction between the shot cup and the bore for increased shot pellet velocity, minimized pellet deformity for more uniform patterns and reduced felt recoil. Browning was the first manufacturer to put back-boring and its advantages into production shotguns. Now we've made the next big leap with Vector Pro. More than 2" longer than the competitors' forcing cone dimensions, Vector Pro's gradual taper minimizes shot deformation for maximum pattern uniformity, consistency and density and more shot right where it needs to be to bring down birds and smoke clays. Vector Pro back-bore specifications are the ideal bore diameters. Any larger and gases blow past the shot cup, resulting in reduced pellet velocity and blown shot patterns. If the bore is smaller, pellets are smashed into the forcing cone, leading to poor ballistic performance and uneven patterning.

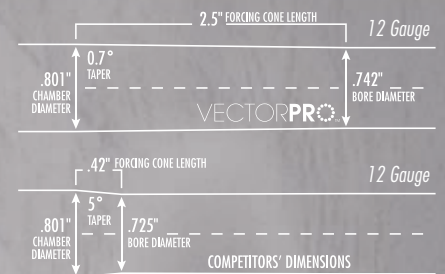

VECTORPRO™

## TOTAL BARREL DYNAMICS

### CHROME CHAMBERS

For increased durability and corrosion resistance, all Cynergy shotguns feature hard chrome-plated chambers to resist the toll that thousands of shells can take on lesser quality guns.

### STEEL SHOT PERFORMANCE



The strength of a Browning barrel is legendary, and built to handle the punishment of steel shot. Unlike some manufacturers' barrels that show pitting after shooting steel, Browning has pioneered construction that maximizes steel shot performance and barrel durability. Browning barrels meet the strictest material and construction quality standards. The barrel blanks are made from rolled and tempered steel bars and are stress relieved to offer exceptional mechanical properties. The barrel blanks are then precision drilled, reamed and honed to exacting specifications. With proper care, Browning Cynergy barrels will last a lifetime.

### IMPACT EJECTORS

Impact Ejectors are aided by the punch of a secondary striker spring for more positive, reliable ejection of fired hulls from the chambers. Unfired shells are elevated for easy removal.



### BACK-BORED TECHNOLOGY

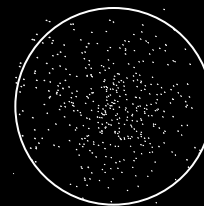

Browning pattern with Back-Bored Technology

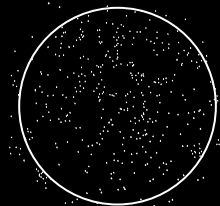

The competitors' pattern without Back-Bored Technology



**CYNERGY FIELD** ▶ GAUGE: 12 (SHOWN), 20, 28, .410 | GLOSS OIL FINISH STOCK AND FOREARM



VECTORPRO



**RECEIVER** - Steel · Silver nitride finish · Ultra-low profile · MonoLock Hinge · Jewelled monobloc · High-relief engraving includes the receiver, forearm iron and top lever (12 gauge models illustrate pheasants and ducks. Small gauge models feature quail and grouse.)

**BARREL** - Lightweight profile · Ventilated top and side ribs

**ACTION** - Reverse Striker ignition system · Impact Ejectors · Top-tang barrel selector/safety

**STOCK** - Gloss oil finish and upgraded Grade II/III walnut

**FEATURES** - Vector Pro™ lengthened forcing cones on 12 and 20 · Three Invector-Plus™ choke tubes on 12 and 20 · Three Standard Invector™ on 28 and .410 · Inflex Technology Recoil Pad System · ¼" stock spacer · Ivory front and mid-bead sights

**CYNERGY FEATHER** ▶ GAUGE: 12 (SHOWN), 20, 28, .410 | GLOSS OIL FINISH STOCK AND FOREARM



VECTORPRO



**RECEIVER** - Lightweight alloy with steel breech face · Gold enhanced grayed finish · Ultra-low profile · MonoLock Hinge · Jewelled monobloc

**BARREL** - Lightweight profile · Ventilated top and side ribs

**ACTION** - Reverse Striker ignition system · Impact Ejectors · Top-tang barrel selector/safety

**STOCK** - Gloss oil finish and upgraded Grade II/III walnut

**FEATURES** - Vector Pro™ lengthened forcing cones on 12 and 20 · Three Invector-Plus™ choke tubes on 12 and 20 · Three Standard Invector™ on 28 and .410 · Inflex Technology Recoil Pad System · ¼" stock spacer · Ivory front and mid-bead sights

**CYNERGY FEATHER COMPOSITE WITH ADJUSTABLE COMB** ▶ GAUGE: 12 | DURA-TOUCH® ARMOR COATING ON STOCK AND FOREARM



DURA-TOUCH®  
Armor Coating

VECTORPRO



**RECEIVER** - Lightweight alloy with steel breech face · Gold enhanced grayed finish · Ultra-low profile · MonoLock Hinge · Jewelled monobloc

**BARREL** - Lightweight profile · Ventilated top and side ribs

**ACTION** - Reverse Striker ignition system · Impact Ejectors · Top-tang barrel selector/safety

**STOCK** - Black composite with rubber overmoldings in grip areas · Dura-Touch® Armor Coating · Adjustable comb

**FEATURES** - Vector Pro™ lengthened forcing cones · Three Invector-Plus™ choke tubes · Inflex Technology Recoil Pad System · ¼" stock spacer · Ivory front and mid-bead sights

GA.	BARREL LENGTH	CODE NUMBER	UPC #	CHOKES INCLUDED	CHAMBER	*AVG. WEIGHT	OVERALL LENGTH	DROP AT COMB	DROP AT HEEL	LENGTH OF PULL	RIB WIDTH	SUGG. RETAIL
<b>CYNERGY FIELD</b>												
12	28"	013297304	023614065142	F, M, IC	3"	7 lbs. 11 oz.	45"	1¾"	2½"	14¼"	⅝"	\$2,679.99
12	26"	013297305	023614065135	F, M, IC	3"	7 lbs. 9 oz.	43"	1¾"	2½"	14¼"	⅝"	2,679.99
20	28"	013297604	023614065166	F, M, IC	3"	6 lbs. 4 oz.	45"	1½"	2⅝"	14¼"	⅜"	2,709.99
20	26"	013297605	023614065159	F, M, IC	3"	6 lbs. 2 oz.	43"	1½"	2⅝"	14¼"	⅜"	2,709.99
28	28"	013297813	023614065180	F, M, IC	2¾"	6 lbs. 4 oz.	45"	1½"	2⅝"	14¼"	⅜"	2,709.99
28	26"	013297814	023614065173	F, M, IC	2¾"	6 lbs. 2 oz.	43"	1½"	2⅝"	14¼"	⅜"	2,709.99
.410	28"	013297913	023614065203	F, M, IC	3"	6 lbs. 1 oz.	45"	1½"	2⅝"	14¼"	⅜"	2,709.99
.410	26"	013297914	023614065197	F, M, IC	3"	5 lbs. 15 oz.	43"	1½"	2⅝"	14¼"	⅜"	2,709.99
<b>CYNERGY FEATHER</b>												
12	28"	013293304	023614064947	F, M, IC	3"	6 lbs. 11 oz.	45"	1⅝"	2½"	14¼"	⅝"	\$2,749.99
12	26"	013293305	023614064930	F, M, IC	3"	6 lbs. 13 oz.	43"	1⅝"	2½"	14¼"	⅝"	2,749.99
20	28"	013293604	023614065029	F, M, IC	3"	5 lbs. 10 oz.	45"	1½"	2⅝"	14¼"	⅜"	2,779.99
20	26"	013293605	023614065012	F, M, IC	3"	5 lbs. 8 oz.	43"	1½"	2⅝"	14¼"	⅜"	2,779.99
28	28"	013293813	023614065074	F, M, IC	2¾"	5 lbs. 15 oz.	45"	1½"	2⅝"	14¼"	⅜"	2,779.99
28	26"	013293814	023614065067	F, M, IC	2¾"	5 lbs. 15 oz.	43"	1½"	2⅝"	14¼"	⅜"	2,779.99
.410	28"	013293913	023614065098	F, M, IC	3"	6 lbs.	45"	1½"	2⅝"	14¼"	⅜"	2,779.99
.410	26"	013293914	023614065081	F, M, IC	3"	6 lbs.	43"	1½"	2⅝"	14¼"	⅜"	2,779.99
<b>CYNERGY FEATHER COMPOSITE WITH ADJUSTABLE COMB</b>												
12	28"	013275304	023614255703	F, M, IC	3"	6 lbs. 9 oz.	45"	1⅝" Adj.	2½" Adj.	14¼"	⅝"	\$2,679.99
12	26"	013275305	023614255697	F, M, IC	3"	6 lbs. 7 oz.	43"	1⅝" Adj.	2½" Adj.	14¼"	⅝"	2,679.99

\*NOTE: Weights listed are approximate.





Cynergy Field, Left



Cynergy Field, Right

**CYNERGY SPORTING** ▶ GAUGE: 12 (SHOWN), 20 | GLOSS OIL FINISH STOCK AND FOREARM

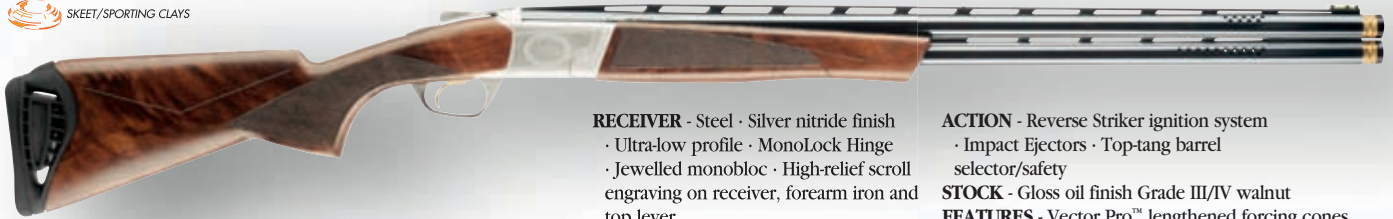

**RECEIVER** - Steel · Silver nitride finish  
 · Ultra-low profile · MonoLock Hinge  
 · Jewelled monobloc · High-relief scroll engraving on receiver, forearm iron and top lever  
**BARREL** - Lightweight profile  
 · Ventilated top and side ribs · Ported

**ACTION** - Reverse Striker ignition system  
 · Impact Ejectors · Top-tang barrel selector/safety  
**STOCK** - Gloss oil finish Grade III/IV walnut  
**FEATURES** - Vector Pro™ lengthened forcing cones  
 · Three Invector-Plus™ Diana™ Grade choke tubes  
 · Inflex Technology Recoil Pad System · Triple Trigger™ System · HiViz® Pro-Comp fiber-optic sight  
 · ¼" stock spacer

VECTORPRO™



**CYNERGY SPORTING WITH ADJUSTABLE COMB** ▶ GAUGE: 12 | GLOSS OIL FINISH STOCK AND FOREARM

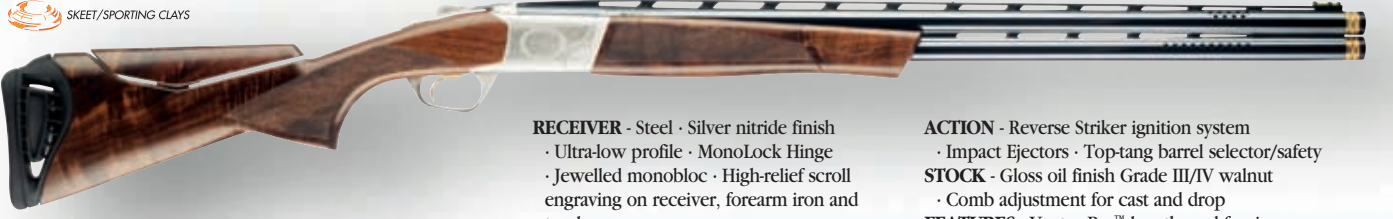

**RECEIVER** - Steel · Silver nitride finish  
 · Ultra-low profile · MonoLock Hinge  
 · Jewelled monobloc · High-relief scroll engraving on receiver, forearm iron and top lever  
**BARREL** - Lightweight profile · Ventilated top and side ribs · Ported

**ACTION** - Reverse Striker ignition system  
 · Impact Ejectors · Top-tang barrel selector/safety  
**STOCK** - Gloss oil finish Grade III/IV walnut  
 · Comb adjustment for cast and drop  
**FEATURES** - Vector Pro™ lengthened forcing cones  
 · Three Invector-Plus™ Diana™ Grade choke tubes  
 · Inflex Technology Recoil Pad System · Triple Trigger™ System · HiViz® Pro-Comp fiber-optic sight  
 · ¼" stock spacer

VECTORPRO™



**CYNERGY SPORTING COMPOSITE WITH ADJUSTABLE COMB** ▶ GAUGE: 12 | DURA-TOUCH® ARMOR COATING ON STOCK AND FOREARM

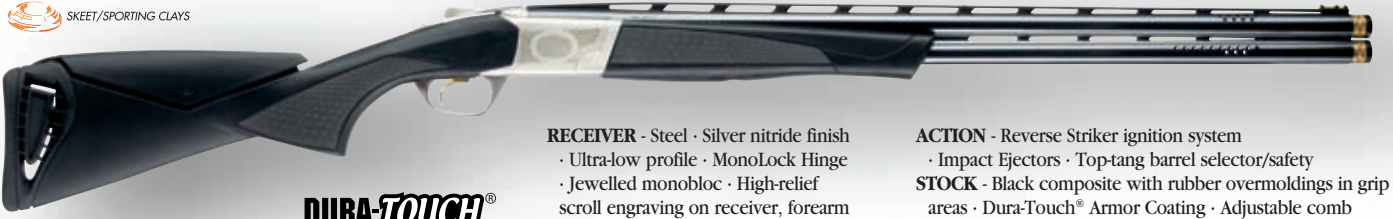

**RECEIVER** - Steel · Silver nitride finish  
 · Ultra-low profile · MonoLock Hinge  
 · Jewelled monobloc · High-relief scroll engraving on receiver, forearm iron and top lever  
**BARREL** - Lightweight profile  
 · Ventilated top and side ribs · Ported

**ACTION** - Reverse Striker ignition system  
 · Impact Ejectors · Top-tang barrel selector/safety  
**STOCK** - Black composite with rubber overmoldings in grip areas · Dura-Touch® Armor Coating · Adjustable comb  
**FEATURES** - Vector Pro™ lengthened forcing cones  
 · Three Invector-Plus™ Diana™ Grade choke tubes  
 · Inflex Technology Recoil Pad System · Triple Trigger™ System · HiViz® Pro-Comp fiber-optic sight · ¼" stock spacer

**DURA-TOUCH®**  
 Armor Coating

VECTORPRO™



GA.	BARREL LENGTH	CODE NUMBER	UPC #	CHOKES INCLUDED	CHAMBER	*AVG. WEIGHT	OVERALL LENGTH	DROP AT COMB	DROP AT HEEL	LENGTH OF PULL	TRIB WIDTH (TAPERED)	SUGG. RETAIL
<b>CYNERGY SPORTING</b>												
12	32"	013294326	023614064978	M, IC, SK	3"	8 lbs. 1 oz.	50"	1 <sup>9</sup> / <sub>16</sub> "	2 <sup>3</sup> / <sub>8</sub> "	14 <sup>1</sup> / <sub>4</sub> "	( <sup>5</sup> / <sub>16</sub> " - <sup>7</sup> / <sub>16</sub> "	\$3,959.99
12	30"	013294327	023614064961	M, IC, SK	3"	7 lbs. 15 oz.	48"	1 <sup>9</sup> / <sub>16</sub> "	2 <sup>3</sup> / <sub>8</sub> "	14 <sup>1</sup> / <sub>4</sub> "	( <sup>5</sup> / <sub>16</sub> " - <sup>7</sup> / <sub>16</sub> "	3,959.99
12	28"	013294328	023614064954	M, IC, SK	3"	7 lbs. 13 oz.	46"	1 <sup>9</sup> / <sub>16</sub> "	2 <sup>3</sup> / <sub>8</sub> "	14 <sup>1</sup> / <sub>4</sub> "	( <sup>5</sup> / <sub>16</sub> " - <sup>7</sup> / <sub>16</sub> "	3,959.99
20	32"	013294626	023614065050	M, IC, SK	3"	6 lbs. 8 oz.	50"	1 <sup>9</sup> / <sub>16</sub> "	2 <sup>3</sup> / <sub>16</sub> "	14 <sup>1</sup> / <sub>4</sub> "	¼"	3,989.99
20	30"	013294627	023614065043	M, IC, SK	3"	6 lbs. 6 oz.	48"	1 <sup>9</sup> / <sub>16</sub> "	2 <sup>3</sup> / <sub>16</sub> "	14 <sup>1</sup> / <sub>4</sub> "	¼"	3,989.99
20	28"	013294628	023614065036	M, IC, SK	3"	6 lbs. 4 oz.	46"	1 <sup>9</sup> / <sub>16</sub> "	2 <sup>3</sup> / <sub>16</sub> "	14 <sup>1</sup> / <sub>4</sub> "	¼"	3,989.99
<b>CYNERGY SPORTING WITH ADJUSTABLE COMB</b>												
12	32"	013295326	023614065005	M, IC, SK	3"	8 lbs. 7 oz.	50"	1 <sup>5</sup> / <sub>16</sub> "	2 <sup>7</sup> / <sub>16</sub> " Adj.	14 <sup>1</sup> / <sub>4</sub> "	( <sup>5</sup> / <sub>16</sub> " - <sup>7</sup> / <sub>16</sub> "	\$4,439.99
12	30"	013295327	023614064992	M, IC, SK	3"	8 lbs. 5 oz.	48"	1 <sup>5</sup> / <sub>16</sub> "	2 <sup>7</sup> / <sub>16</sub> " Adj.	14 <sup>1</sup> / <sub>4</sub> "	( <sup>5</sup> / <sub>16</sub> " - <sup>7</sup> / <sub>16</sub> "	4,439.99
12	28"	013295328	023614064985	M, IC, SK	3"	8 lbs. 3 oz.	46"	1 <sup>5</sup> / <sub>16</sub> "	2 <sup>7</sup> / <sub>16</sub> " Adj.	14 <sup>1</sup> / <sub>4</sub> "	( <sup>5</sup> / <sub>16</sub> " - <sup>7</sup> / <sub>16</sub> "	4,439.99
<b>CYNERGY SPORTING COMPOSITE WITH ADJUSTABLE COMB</b>												
12	32"	013296326	023614065128	M, IC, SK	3"	7 lbs. 13 oz.	50"	1 <sup>9</sup> / <sub>16</sub> " Adj.	2 <sup>3</sup> / <sub>8</sub> " Adj.	14 <sup>1</sup> / <sub>4</sub> "	( <sup>5</sup> / <sub>16</sub> " - <sup>7</sup> / <sub>16</sub> "	\$3,819.99
12	30"	013296327	023614065111	M, IC, SK	3"	7 lbs. 11 oz.	48"	1 <sup>9</sup> / <sub>16</sub> " Adj.	2 <sup>3</sup> / <sub>8</sub> " Adj.	14 <sup>1</sup> / <sub>4</sub> "	( <sup>5</sup> / <sub>16</sub> " - <sup>7</sup> / <sub>16</sub> "	3,819.99
12	28"	013296328	023614065104	M, IC, SK	3"	7 lbs. 9 oz.	46"	1 <sup>9</sup> / <sub>16</sub> " Adj.	2 <sup>3</sup> / <sub>8</sub> " Adj.	14 <sup>1</sup> / <sub>4</sub> "	( <sup>5</sup> / <sub>16</sub> " - <sup>7</sup> / <sub>16</sub> "	3,819.99

\*NOTE: Weights listed are approximate.



**CYNERGY CLASSIC FIELD GRADE III** ▶ GAUGE: 12 (SHOWN), 20 | GLOSS FINISH STOCK AND FOREARM



VECTORPRO™



Cynergy Classic Field Gr. III  
12 Gauge, Bottom

Cynergy Classic Field Gr. III  
12 Gauge, Left

Cynergy Classic Field Gr. III  
12 Gauge, Right

Cynergy Classic Field Gr. III  
20 Gauge, Bottom

Cynergy Classic Field Gr. III  
20 Gauge, Left

Cynergy Classic Field Gr. III  
20 Gauge, Right

**RECEIVER** - Steel · Silver nitride finish · Ultra-low profile  
· Jewelled monobloc · MonoLock Hinge · High-relief engraving includes the trigger guard, tang and top lever (12 gauge models illustrate pheasants on the left, mallards on the right. 20 gauge models feature teal and partridge.)

**BARREL** - Lightweight profile  
· Ventilated top and side ribs  
**ACTION** - Reverse Striker ignition system · Impact Ejectors · Top-tang barrel selector/safety

**STOCK** - Gloss finish Grade III/IV walnut  
**FEATURES** - Vector Pro™ lengthened forcing cones  
· Three Invector-Plus™ choke tubes · Ivory front and mid-bead sights · Recoil pad on 12 gauge model

**CYNERGY CLASSIC FIELD GRADE VI** ▶ GAUGE: 12 (SHOWN), 20 | GLOSS FINISH STOCK AND FOREARM



VECTORPRO™



Cynergy Classic Field Gr. VI  
12 Gauge, Bottom

Cynergy Classic Field Gr. VI  
12 Gauge, Left

Cynergy Classic Field Gr. VI  
12 Gauge, Right

Cynergy Classic Field Gr. VI  
20 Gauge, Bottom

Cynergy Classic Field Gr. VI  
20 Gauge, Left

Cynergy Classic Field Gr. VI  
20 Gauge, Right

**RECEIVER** - Steel · Silver nitride finish · Ultra-low profile  
· Jewelled monobloc · MonoLock Hinge · Full coverage high-relief engraving is gold enhanced and includes the trigger guard, tang and top lever (12 gauge models illustrate pheasants on the right, mallards on the left. 20 gauge models feature quail and grouse.)

**BARREL** - Lightweight profile  
· Ventilated top and side ribs  
**ACTION** - Reverse Striker ignition system  
· Impact Ejectors · Top-tang barrel selector/safety

**STOCK** - Gloss finish Grade V/VI walnut  
**FEATURES** - Vector Pro™ lengthened forcing cones  
· Three Invector-Plus™ choke tubes · Ivory front and mid-bead sights · Recoil pad on 12 gauge model

GA.	BARREL LENGTH	CODE NUMBER	UPC #	CHOKES INCLUDED	CHAMBER	*AVG. WEIGHT	OVERALL LENGTH	DROP AT COMB	DROP AT HEEL	LENGTH OF PULL	RIB WIDTH	SUGG. RETAIL
<b>CYNERGY CLASSIC FIELD GRADE III</b>												
12	28"	013252304	023614251248	F, M, IC	3"	8 lbs. 1 oz.	45"	1 5/8"	2 1/2"	14 1/4"	5/16"	\$3,819.99
12	26"	013252305	023614251231	F, M, IC	3"	7 lbs. 15 oz.	43"	1 5/8"	2 1/2"	14 1/4"	5/16"	3,819.99
20	28"	013252604	023614254980	F, M, IC	3"	6 lbs. 10 oz.	45"	1 1/2"	2 3/8"	14 1/4"	7/32"	3,859.99
20	26"	013252605	023614254973	F, M, IC	3"	6 lbs. 8 oz.	43"	1 1/2"	2 3/8"	14 1/4"	7/32"	3,859.99
<b>CYNERGY CLASSIC FIELD GRADE VI</b>												
12	28"	013253304	023614251262	F, M, IC	3"	8 lbs. 1 oz.	45"	1 5/8"	2 1/2"	14 1/4"	5/16"	\$5,799.99
12	26"	013253305	023614251255	F, M, IC	3"	7 lbs. 15 oz.	43"	1 5/8"	2 1/2"	14 1/4"	5/16"	5,799.99
20	28"	013253604	023614255000	F, M, IC	3"	6 lbs. 10 oz.	45"	1 1/2"	2 3/8"	14 1/4"	7/32"	5,829.99
20	26"	013253605	023614254997	F, M, IC	3"	6 lbs. 8 oz.	43"	1 1/2"	2 3/8"	14 1/4"	7/32"	5,829.99

\*NOTE: Weights listed are approximate.



**CYNERGY CLASSIC FIELD** ▶ GAUGE: 12 (SHOWN), 20, 28, .410 | GLOSS OIL FINISH STOCK AND FOREARM

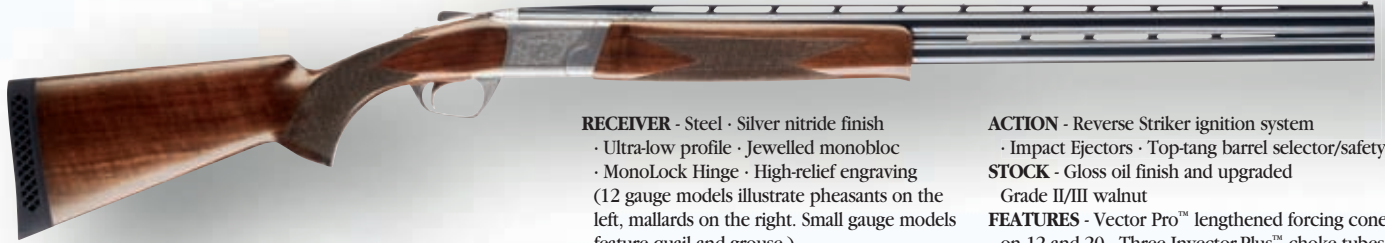

VECTORPRO™



**RECEIVER** - Steel · Silver nitride finish  
 · Ultra-low profile · Jewelled monobloc  
 · MonoLock Hinge · High-relief engraving  
 (12 gauge models illustrate pheasants on the left, mallards on the right. Small gauge models feature quail and grouse.)  
**BARREL** - Lightweight profile · Ventilated top and side ribs

**ACTION** - Reverse Striker ignition system  
 · Impact Ejectors · Top-tang barrel selector/safety  
**STOCK** - Gloss oil finish and upgraded Grade II/III walnut  
**FEATURES** - Vector Pro™ lengthened forcing cones on 12 and 20 · Three Invector-Plus™ choke tubes on 12 and 20 · Three Standard Invector™ on 28 and .410 · Ivory front and mid-bead sights · Recoil pad on 12 gauge model



Cynergy Classic Field 12 Gauge, Left



Cynergy Classic Field 12 Gauge, Right



Cynergy Classic Field 12 Gauge, Bottom

**CYNERGY CLASSIC SPORTING** ▶ GAUGE: 12 (SHOWN), 20, 28, .410 | GLOSS OIL FINISH STOCK AND FOREARM



**RECEIVER** - Steel · Silver nitride finish  
 · Ultra-low profile · Jewelled monobloc  
 · MonoLock Hinge

**BARREL** - Lightweight profile  
 · Ventilated top and side ribs · Ported

**ACTION** - Reverse Striker ignition system  
 · Impact Ejectors · Top-tang barrel selector/safety

**STOCK** - Gloss oil finish Grade III/IV walnut  
**FEATURES** - Vector Pro™ lengthened forcing cones on 12 and 20 · Three Invector-Plus™ Midas™ Grade choke tubes on 12 and 20 · Three Standard Invector™ on 28 and .410 · Triple Trigger™ System · HiViz® Pro-Comp fiber-optic sight



Cynergy Classic Sporting, Right



Cynergy Classic Sporting, Bottom

VECTORPRO™



GA.	BARREL LENGTH	CODE NUMBER	UPC #	CHOKES INCLUDED	CHAMBER	*AVG. WEIGHT	OVERALL LENGTH	DROP AT COMB	DROP AT HEEL	LENGTH OF PULL	RIB WIDTH (TAPERED)	SUGG. RETAIL
<b>CYNERGY CLASSIC FIELD</b>												
12	28"	013702304	023614067610	F, M, IC	3"	7 lbs. 13 oz.	45"	1 5/8"	2 1/2"	14 1/4"	5/16"	\$2,429.99
12	26"	013702305	023614067603	F, M, IC	3"	7 lbs. 11 oz.	43"	1 5/8"	2 1/2"	14 1/4"	5/16"	2,429.99
20	28"	013702604	023614067634	F, M, IC	3"	6 lbs. 6 oz.	45"	1 1/2"	2 3/8"	14 1/4"	7/32"	2,459.99
20	26"	013702605	023614067627	F, M, IC	3"	6 lbs. 4 oz.	43"	1 1/2"	2 3/8"	14 1/4"	7/32"	2,459.99
28	28"	013702813	023614067658	F, M, IC	2 3/4"	6 lbs. 9 oz.	45"	1 1/2"	2 3/8"	14 1/4"	7/32"	2,459.99
28	26"	013702814	023614067641	F, M, IC	2 3/4"	6 lbs. 7 oz.	43"	1 1/2"	2 3/8"	14 1/4"	7/32"	2,459.99
.410	28"	013702913	023614067672	F, M, IC	3"	6 lbs. 6 oz.	45"	1 1/2"	2 3/8"	14 1/4"	7/32"	2,459.99
.410	26"	013702914	023614067665	F, M, IC	3"	6 lbs. 4 oz.	43"	1 1/2"	2 3/8"	14 1/4"	7/32"	2,459.99
<b>CYNERGY CLASSIC SPORTING</b>												
12	32"	013703326	023614067702	M, IC, SK	3"	7 lbs. 15 oz.	50"	1 3/8"	2 3/8"	14 3/4"	(5/16" - 7/16")	\$3,509.99
12	30"	013703327	023614067696	M, IC, SK	3"	7 lbs. 13 oz.	48"	1 3/8"	2 3/8"	14 3/4"	(5/16" - 7/16")	3,509.99
12	28"	013703328	023614067689	M, IC, SK	3"	7 lbs. 11 oz.	46"	1 3/8"	2 3/8"	14 3/4"	(5/16" - 7/16")	3,509.99
20	32"	013703626	023614067764	M, IC, SK	3"	6 lbs. 8 oz.	50"	1 3/8"	2 3/8"	14 3/4"	1/4"	3,549.99
20	30"	013703627	023614067757	M, IC, SK	3"	6 lbs. 6 oz.	48"	1 3/8"	2 3/8"	14 3/4"	1/4"	3,549.99
20	28"	013703628	023614067740	M, IC, SK	3"	6 lbs. 4 oz.	46"	1 3/8"	2 3/8"	14 3/4"	1/4"	3,549.99
28	30"	013703812	023614067818	M, IC, SK	2 3/4"	6 lbs. 9 oz.	48"	1 3/8"	2 3/8"	14 3/4"	1/4"	3,549.99
28	28"	013703813	023614067801	M, IC, SK	2 3/4"	6 lbs. 7 oz.	46"	1 3/8"	2 3/8"	14 3/4"	1/4"	3,549.99
.410	30"	013703912	023614067832	M, IC, SK	3"	6 lbs. 6 oz.	48"	1 3/8"	2 3/8"	14 3/4"	1/4"	3,549.99
.410	28"	013703913	023614067825	M, IC, SK	3"	6 lbs. 4 oz.	46"	1 3/8"	2 3/8"	14 3/4"	1/4"	3,549.99

\*NOTE: Weights listed are approximate.



**CYNERGY CLASSIC SPORTING WITH ADJUSTABLE COMB** ▶ GAUGE: 12 (SHOWN), 20 | GLOSS OIL FINISH STOCK AND FOREARM



**RECEIVER** - Steel · Silver nitride finish  
 · Ultra-low profile · Jewelled monobloc  
 · MonoLock Hinge  
**BARREL** - Lightweight profile  
 · Ventilated top and side ribs · Ported

**ACTION** - Reverse Striker ignition system  
 · Impact Ejectors · Top-tang barrel selector/safety  
**STOCK** - Grade III/IV gloss oil finish walnut  
**FEATURES** - Vector Pro™ lengthened forcing cones · Three Invector-Plus™ Midas™ Grade choke tubes · Triple Trigger™ System · HiViz® Pro-Comp fiber-optic sight



Cynergy Classic Sporting, Right



Cynergy Classic Sporting, Bottom



**CYNERGY CLASSIC TRAP** ▶ GAUGE: 12 | GLOSS FINISH STOCK AND FOREARM



**RECEIVER** - Steel · Silver nitride finish  
 · Ultra-low profile · Jewelled monobloc  
 · MonoLock Hinge  
**BARREL** - Lightweight profile  
 · Tapered floating top rib · Ported  
**ACTION** - Reverse Striker ignition system  
 · Impact Ejectors · Top-tang barrel selector/safety

**STOCK** - Gloss finish Monte Carlo Grade III/IV walnut stock with right-hand palm swell  
 · Modified semi-beavertail forearm with finger grooves  
**FEATURES** - Vector Pro™ lengthened forcing cones · Three Invector-Plus™ Midas™ Grade choke tubes · Triple Trigger™ System · HiViz® Pro-Comp fiber-optic sight



**CYNERGY CLASSIC TRAP WITH ADJUSTABLE COMB** ▶ GAUGE: 12 | GLOSS FINISH STOCK AND FOREARM



**RECEIVER** - Steel · Silver nitride finish  
 · Ultra-low profile · Jewelled monobloc  
 · MonoLock Hinge  
**BARREL** - Lightweight profile  
 · Tapered floating top rib · Ported  
**ACTION** - Reverse Striker ignition system  
 · Impact Ejectors · Top-tang barrel selector/safety

**STOCK** - Gloss finish Monte Carlo Grade III/IV walnut stock with right-hand palm swell  
 · Modified semi-beavertail forearm with finger grooves  
**FEATURES** - Vector Pro™ lengthened forcing cones · Three Invector-Plus™ Midas™ Grade choke tubes · Triple Trigger™ System · HiViz® Pro-Comp fiber-optic sight



GA.	BARREL LENGTH	CODE NUMBER	UPC #	CHOKES INCLUDED	CHAMBER	*AVG. WEIGHT	OVERALL LENGTH	DROP AT COMB	DROP AT HEEL	LENGTH OF PULL	RIB WIDTH (TAPERED)	SUGG. RETAIL
<b>CYNERGY CLASSIC SPORTING WITH ADJUSTABLE COMB</b>												
12	32"	013704326	023614067733	M, IC, SK	3"	8 lbs. 11 oz.	50"	1¾" Adj.	2½" Adj.	14¾"	(⅝" - 7/16")	\$3,859.99
12	30"	013704327	023614067726	M, IC, SK	3"	8 lbs. 9 oz.	48"	1¾" Adj.	2½" Adj.	14¾"	(⅝" - 7/16")	3,859.99
12	28"	013704328	023614067719	M, IC, SK	3"	8 lbs. 7 oz.	46"	1¾" Adj.	2½" Adj.	14¾"	(⅝" - 7/16")	3,859.99
20	32"	013704626	023614067795	M, IC, SK	3"	7 lbs. 4 oz.	50"	1⅝" Adj.	2⅝" Adj.	14¾"	¼"	3,879.99
20	30"	013704627	023614067788	M, IC, SK	3"	7 lbs. 2 oz.	48"	1⅝" Adj.	2⅝" Adj.	14¾"	¼"	3,879.99
20	28"	013704628	023614067771	M, IC, SK	3"	7 lbs.	46"	1⅝" Adj.	2⅝" Adj.	14¾"	¼"	3,879.99
<b>CYNERGY CLASSIC TRAP</b>												
12	32"	013235426	023614255109	F, F, IM	2¾"	8 lbs. 12 oz.	50¼"	1⅞"	2"	14⅝"	(¼" - ⅜")	\$3,779.99
12	30"	013235427	023614255093	F, F, IM	2¾"	8 lbs. 10 oz.	48¼"	1⅞"	2"	14⅝"	(¼" - ⅜")	3,779.99
<b>CYNERGY CLASSIC TRAP WITH ADJUSTABLE COMB</b>												
12	32"	013254426	023614255123	F, F, IM	2¾"	8 lbs. 15 oz.	50¼"	1⅞" Adj.	2" Adj.	14⅝"	(¼" - ⅜")	\$4,199.99
12	30"	013254427	023614255116	F, F, IM	2¾"	8 lbs. 13 oz.	48¼"	1⅞" Adj.	2" Adj.	14⅝"	(¼" - ⅜")	4,199.99

\*NOTE: Weights listed are approximate.



**CYNERGY CLASSIC TRAP UNSINGLE COMBO WITH ADJUSTABLE COMB** ▶ GAUGE: 12 | GLOSS FINISH STOCK AND FOREARM



VECTORPRO™



**RECEIVER** - Steel · Silver nitride finish  
 · Ultra-low profile · Jewelled monobloc  
 · MonoLock Hinge

**BARREL** - Double and single barrel sets included  
 · Lightweight profile over and under barrel set  
 · Single barrel set features an adjustable Unsingle Rib for fine tuning of rib angle for sight picture and point of impact · Ported

**ACTION** - Reverse Striker ignition system  
 · Impact Ejectors · Top-tang barrel selector/safety

**STOCK** - Gloss finish Monte Carlo Grade III/IV walnut stock with right-hand palm swell  
 · Modified semi-beavertail forearm with finger grooves

**FEATURES** - Vector Pro™ lengthened forcing cones  
 · Four Invector-Plus™ Midas™ Grade choke tubes  
 · Triple Trigger™ System · HiViz® Pro-Comp fiber-optic sight · Green canvas fitted case with Browning Cynergy logo



GA.	BARREL LENGTH	CODE NUMBER	UPC #	CHOKES INCLUDED	CHAMBER	*AVG. WEIGHT	OVERALL LENGTHS	DROP AT COMB	DROP AT HEEL	LENGTH OF PULL	RIB WIDTH (TAPERED)	SUGG. RETAIL
12	32"/34"	013269479	023614257585	F, F, F, IM	2¾"	8 lbs. 15 oz.	48¼" / 50¼"	1½" Adj.	2" Adj.	14¾"	(¼" - ¾")	\$5,719.99
12	32"/32"	013269469	023614257578	F, F, F, IM	2¾"	8 lbs. 15 oz.	48¾"	1½" Adj.	2" Adj.	14¾"	(¼" - ¾")	5,719.99
12	30"/34"	013269468	023614257561	F, F, F, IM	2¾"	8 lbs. 13 oz.	46¼" / 50¼"	1½" Adj.	2" Adj.	14¾"	(¼" - ¾")	5,719.99
12	30"/32"	013269467	023614257554	F, F, F, IM	2¾"	8 lbs. 13 oz.	46¼" / 48¼"	1½" Adj.	2" Adj.	14¾"	(¼" - ¾")	5,719.99

\*NOTE: Weights listed are approximate.

**CYNERGY ACCESSORIES** ▶ RECOIL PADS | SPACERS | COMBS

Recoil Pads for Composite Models\*



Recoil Pads for Wood Models\*



Spacers



DESCRIPTION	CODE #	UPC #	SUGG. RETAIL
Short Composite Recoil Pad	11400	023614191650	\$34.99
Medium Composite Recoil Pad	11401	023614191667	34.99
Long Composite Recoil Pad	11402	023614191674	34.99
Short Wood Recoil Pad	11410	023614191681	34.99
Medium Wood Recoil Pad	11411	023614191698	34.99
Long Wood Recoil Pad	11412	023614191704	34.99
¼" Composite Stock Spacer	11430	023614191735	7.99
¼" Wood Stock Spacer	11431	023614191742	7.99
Cast-on Adj. Comb, Composite	11420	023614191711	24.99
Cast-off Adj. Comb, Composite	11421	023614191728	24.99

\*NOTE: All new guns are shipped with medium pads.

Length of pull is adjustable from 13¼"-15" with the purchase of the recoil pads and stock spacers above. See page 20 for details on Inflex pads.

Composite Model Adjustable Comb



# BT-99

TOTAL BARREL DYNAMICS

## INVECTOR-PLUS™ CHOKE TUBE SYSTEM

The Invector-Plus interchangeable choke tube system provides consistent, dense shot patterns in the constriction needed for your shooting situation. The longer choke taper inside an Invector-Plus choke tube works with Back-Bored Technology to produce patterns with more uniform densities and fewer fliers. The superior design eliminates gases slipping between the choke tube and barrel that could damage the choke tube and the barrel. See pages 146 to 149 for a complete listing of choke tubes.

## CHROME CHAMBERS

The BT-99 features a chrome-plated chamber to resist the toll thousands of shells can take on lesser quality guns. Corrosion resistance is also greatly improved.

**BROWNING QUALITY AT ITS BEST.** When it comes to performance and durability, dollar-for-dollar there isn't a better single-barrel trap gun than the rugged BT-99. These no-nonsense guns are built for the long haul, and are always ready to put you at the top of your game.

## VECTOR PRO™ LENGTHENED FORCING CONE

Back-boring reduces friction between the shot cup and the bore for increased shot pellet velocity, minimized pellet deformity for more uniform patterns and reduced felt recoil. The Vector Pro forcing cone is over 2" longer than the competitor's. Vector Pro's gradual taper minimizes shot deformation for maximum pattern uniformity, consistency and density and more shot right where it needs to be to smoke clays.

VECTORPRO™

All Browning firearms are shipped with a free locking device to assist in the safe storage of firearms.



### FOREARM

A beavertail forearm helps control recoil and assists hand-eye coordination.



### RIB

High-post, 1/32" rib.

**EXTRACTOR** The BT-99 features an extractor to lift hulls.

## BT-99 GRADE III ▶ GAUGE: 12 | GLOSS FINISH STOCK AND FOREARM

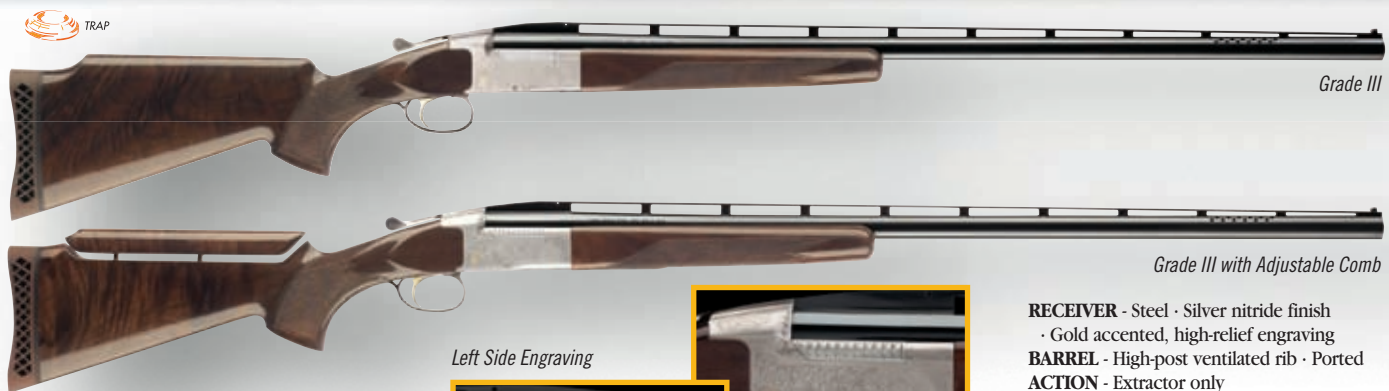

Grade III

Grade III with Adjustable Comb

Left Side Engraving

Right Side Engraving



- RECEIVER** - Steel · Silver nitride finish · Gold accented, high-relief engraving
- BARREL** - High-post ventilated rib · Ported
- ACTION** - Extractor only
- STOCK** - Gloss finish Monte Carlo Grade III/IV walnut stock · Beavertail forearm
- FEATURES** - Vector-Pro™ lengthened forcing cone · Three Invector-Plus™ choke tubes · Adjustable comb optional · Ivory front and mid-head sights

GA.	BARREL LENGTH	CODE NUMBER	UPC #	CHOKES INCLUDED	CHAMBER	*AVG. WEIGHT	OVERALL LENGTH	DROP AT COMB	DROP AT HEEL	LENGTH OF PULL	RIB WIDTH	SUGG. RETAIL
<b>BT-99 GRADE III</b>												
12	34"	017070425	023614258650	F, IM, M	2¾"	8 lbs. 6 oz.	51"	1⅜"	2"	14⅜"	1⅜"	\$2,429.99
12	32"	017070426	023614258643	F, IM, M	2¾"	8 lbs. 5 oz.	49"	1⅜"	2"	14⅜"	1⅜"	2,429.99
<b>BT-99 GRADE III WITH ADJUSTABLE COMB</b>												
12	34"	017071425	023614258674	F, IM, M	2¾"	8 lbs. 6 oz.	51"	1¼" Adj.	2" Adj.	14⅜"	1⅜"	\$2,699.99
12	32"	017071426	023614258667	F, IM, M	2¾"	8 lbs. 5 oz.	49"	1¼" Adj.	2" Adj.	14⅜"	1⅜"	2,699.99

\*NOTE: Weights listed are approximate.



**BT-99 GOLDEN CLAYS WITH ADJUSTABLE COMB** ▶ GAUGE: 12 | GLOSS FINISH STOCK AND FOREARM

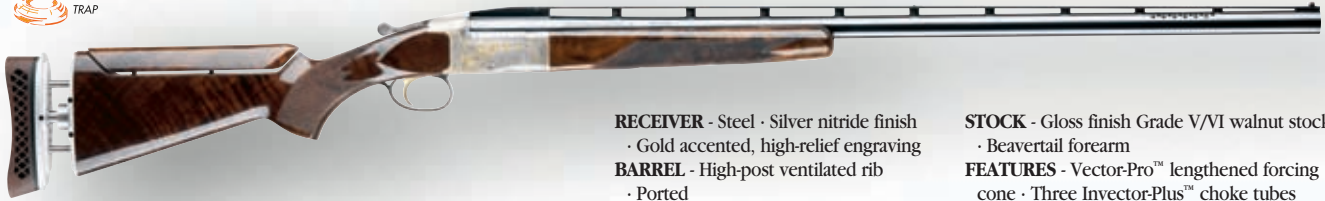

VECTORPRO™



**RECEIVER** - Steel · Silver nitride finish  
· Gold accented, high-relief engraving  
**BARREL** - High-post ventilated rib  
· Ported  
**ACTION** - Extractor only

**STOCK** - Gloss finish Grade V/VI walnut stock  
· Beavertail forearm  
**FEATURES** - Vector-Pro™ lengthened forcing cone · Three Invector-Plus™ choke tubes  
· Adjustable straight comb · Adjustable GraCoil® recoil reduction system · Ivory front and mid-bead sights

**BT-99** ▶ GAUGE: 12 | SATIN FINISH STOCK AND FOREARM

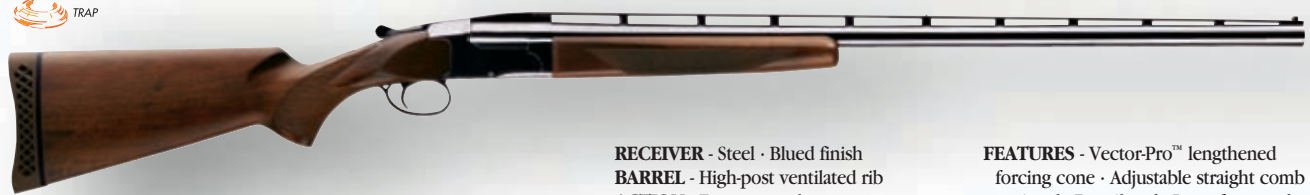

VECTORPRO™



**RECEIVER** - Steel · Blued finish  
**BARREL** - High-post ventilated rib  
**ACTION** - Extractor only  
**STOCK** - Satin finish walnut stock  
· Beavertail forearm

**FEATURES** - Vector-Pro™ lengthened forcing cone · Adjustable straight comb optional · Recoil pad · Ivory front and mid-bead sights · One Invector-Plus™ choke tube

**BT-99 MICRO** ▶ GAUGE: 12 | SATIN FINISH STOCK AND FOREARM

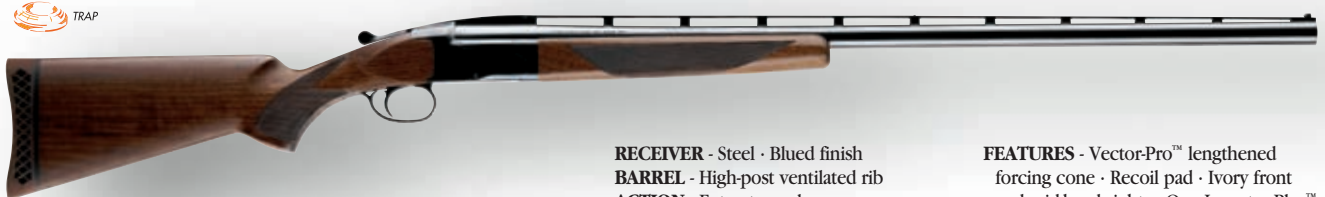

VECTORPRO™



**RECEIVER** - Steel · Blued finish  
**BARREL** - High-post ventilated rib  
**ACTION** - Extractor only  
**STOCK** - Satin finish walnut stock  
· Beavertail forearm · Scaled down to comfortably fit smaller shooters

**FEATURES** - Vector-Pro™ lengthened forcing cone · Recoil pad · Ivory front and mid-bead sights · One Invector-Plus™ choke tube

GA.	BARREL LENGTH	CODE NUMBER	UPC #	CHOKES INCLUDED	CHAMBER	*AVG. WEIGHT	OVERALL LENGTH	DROP AT COMB	DROP AT HEEL	LENGTH OF PULL	RIB WIDTH	SUGG. RETAIL
<b>BT-99 GOLDEN CLAYS WITH ADJUSTABLE COMB</b>												
12	34"	017057401	023614241881	F, IM, M	2¾"	9 lbs.	51"	1½" Adj.	1¾" Adj.	13¾" - 14¾"	1½"	\$4,119.99
12	32"	017057402	023614241898	F, IM, M	2¾"	8 lbs. 15 oz.	49"	1½" Adj.	1¾" Adj.	13¾" - 14¾"	1½"	4,119.99
<b>BT-99 (SHOWN)</b>												
12	34"	017054401	023614236917	Full	2¾"	8 lbs. 5 oz.	51"	1½"	1½"	14¾"	1½"	\$1,339.99
12	32"	017054402	023614236924	Full	2¾"	8 lbs. 4 oz.	49"	1½"	1½"	14¾"	1½"	1,339.99
<b>BT-99 WITH ADJUSTABLE COMB</b>												
12	34"	017055401	023614236931	Full	2¾"	8 lbs. 5 oz.	51"	1½" Adj.	1¾" Adj.	14¾"	1½"	\$1,599.99
12	32"	017055402	023614236948	Full	2¾"	8 lbs. 4 oz.	49"	1½" Adj.	1¾" Adj.	14¾"	1½"	1,599.99
<b>BT-99 MICRO</b>												
12	32"	017061402	023614245889	Full	2¾"	7 lbs. 13 oz.	48½"	1½"	1½"	13¾"	1½"	\$1,339.99
12	30"	017061403	023614245872	Full	2¾"	7 lbs. 12 oz.	46½"	1½"	1½"	13¾"	1½"	1,339.99

\*NOTE: Weights listed are approximate.

**BROWNING GROWTH INSURANCE PROGRAM**

It's a fact, kids grow. Which makes purchasing a firearm for them a difficult decision. Should you buy an inexpensive "youth" model with questionable quality that they will soon grow out of? Or should you buy a well-made, but ill-fitting, full-size firearm that won't let them shoot to their potential because of poor fit? Fortunately, Browning offers the perfect solution for both now and later with the Growth Insurance Program. For a limited time, with the purchase of a new Browning Micro Midas or Micro firearm, you are eligible to purchase a full-size stock at 50% off the retail price. That's a big savings for you, and allows them to enjoy a firearm of the highest quality that is sure to fit and maximize their shooting performance and enjoyment for years to come. Visit [browning.com](http://browning.com) for complete details.





# Silver

## BROWNING QUALITY AND LASTING VALUE.

The name Browning will forever be associated with the best autoloading shotguns you can buy. Dollar-for-dollar, there is not a better deal than a Silver. These value-added guns give you the highest levels of craftsmanship, handling and versatility and are priced within everyone's budget.

## TOTAL BARREL DYNAMICS

### BACK-BORED BARREL TECHNOLOGY

Back-boring reduces friction between the shot cup and the bore for increased shot pellet velocity, minimized pellet deformity for more uniform patterns and reduced felt recoil. Browning was the first manufacturer to put back-boring and its advantages into production shotguns. Through intense research, our back-bore specifications have been perfected and represent the ideal bore diameter needed to minimize shot deformation and maximize pattern uniformity, consistency and density. Any larger and gases slip by the shot cup, resulting in reduced pellet velocity and blown patterns. Any smaller, and the forcing cone will deform pellets and result in poor ballistic performance, fliers and uneven, spotty pellet coverage on the target.

### INVECTOR-PLUS™ CHOKE TUBE SYSTEM

The proven Invector-Plus interchangeable choke tube system comes on every Silver shotgun to provide consistent, dense shot patterns in just the constriction needed for your shooting situation. The longer choke taper inside an Invector-Plus choke tube works hand-in-hand with Back-Bored Technology to produce consistent patterns with more uniform densities and fewer fliers. The superior design of the Invector-Plus system is far more durable than the choke systems found in competitors' guns, especially when shooting steel shot loads. Invector-Plus eliminates gases slipping between the choke tube and barrel that could damage the choke tube and the barrel. See pages 146 to 149 for a complete listing of choke tubes.

### STEEL SHOT PERFORMANCE

The strength of a Browning barrel is legendary, and built to handle the punishment of steel shot. Unlike some manufacturers' barrels that show pitting after shooting steel, Browning has pioneered construction that maximizes steel shot performance and barrel durability. Browning barrels meet the strictest material and construction quality standards. The barrel blanks are made from rolled and tempered steel bars and are stress relieved to offer exceptional mechanical properties. The barrel blanks are then precision drilled, reamed and honed to exacting specifications. With proper care, a Browning Silver barrel will last a lifetime.



### BACK-BORED TECHNOLOGY

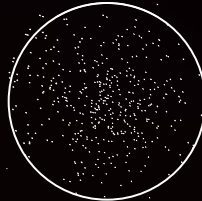

Browning pattern with Back-Bored Technology

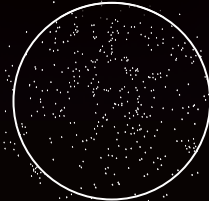

The competitors' pattern without Back-Bored Technology



### TRIGGER

The trigger guard is large and has carefully rounded edges to accommodate gloved fingers. Additionally, the Silver's entire trigger assembly can be removed in just seconds for thorough cleaning.

### MAGAZINE CAPACITY

2¾": Four in magazine, one in chamber.

3": Three in magazine, one in chamber.

3½": Three in magazine, one in chamber.

(A three-shot magazine adapter plug is included.)

### MAXIMUM GRIP

Composite Silver models combine checkered gripping surfaces and proven Dura-Touch® Armor Coating for a sure hold and a sleek feel in all climate conditions.





### LESS RECOIL WITH THE ACTIVE VALVE

The self-adjusting Active Valve gas system in Silver autoloaders diverts gases from fired shells to operate the action instead of adding to recoil. When shooting light loads, most of the gases operate the action. With magnum loads, only a small amount of gas is necessary to operate the action, while the remaining gases are vented through the Active Valve and out the top of the forearm and away from the receiver for clean, reliable operation. The gas piston and Active Valve operate independently, putting less pressure on the gas piston for greater longevity and more efficient operation than the competitors' gas-operated autoloaders. Because the Active Valve expels unnecessary gases, it reduces recoil before it ever strikes your shoulder — without the need for heavy hydraulic recoil dampers, sticky gel pads and gimmicky gel stock inserts. Superior recoil reduction from the Active Valve also equals faster, more accurate follow-up shots and all-day shooting comfort regardless of the loads you shoot.

All Browning firearms are shipped with a free locking device to assist in the safe storage of firearms.

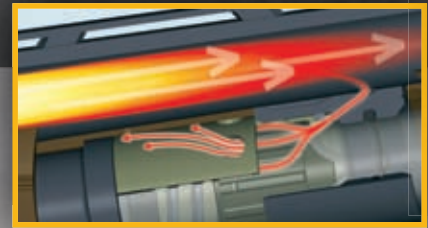

Light Load (1 oz.)



Heavy Load (2 oz.)



**LOAD VERSATILITY** The Active Valve-equipped gas piston efficiently adjusts to reliably fire a wide range of loads. 12 gauge 3" models fire everything from light, 1 oz., 2<sup>3</sup>/<sub>4</sub>" target loads to the heaviest 3" magnums. The larger 3<sup>1</sup>/<sub>2</sub>" version is built to handle a similar range, from 1<sup>1</sup>/<sub>8</sub> oz., 2<sup>3</sup>/<sub>4</sub>" field loads up to hard-hitting 3<sup>1</sup>/<sub>2</sub>" magnums. Competitors' guns can't match this versatility.

**SILVER HUNTER MICRO MIDAS** ▶ GAUGE: 12 (SHOWN), 20 | SATIN FINISH STOCK AND FOREARM

**NEW**



**RECEIVER** - Strong, lightweight aluminum alloy · Semi-humpback design · Silver finish  
**BARREL** - Lightweight profile  
 · Ventilated rib  
**ACTION** - Gas-operated autoloader  
 · 3" chamber · Active Valve reliably cycles a wide range of loads

**STOCK** - Satin finish walnut stock and forearm  
 · Compact 13" length of pull for smaller shooters  
**FEATURES** - Three Invector-Plus™ choke tubes  
 · Ivory front bead sight · One 1/4" stock spacer

	GA.	BARREL LENGTH	CODE NUMBER	UPC#	CHOKES INCLUDED	CHAMBER	*AVG. WEIGHT	OVERALL LENGTH	DROP AT COMB	DROP AT HEEL	LENGTH OF PULL	RIB WIDTH	SUGG. RETAIL
<b>NEW</b>	12	26"	011389305	023614071013	F, M, IC	3"	7 lbs. 5 oz.	45 <sup>3</sup> / <sub>4</sub> "	1 <sup>1</sup> / <sub>2</sub> "	1 <sup>3</sup> / <sub>4</sub> "	13"	1/4"	\$1,069.99
<b>NEW</b>	12	24"	011389306	023614071020	F, M, IC	3"	7 lbs. 3 oz.	43 <sup>3</sup> / <sub>4</sub> "	1 <sup>1</sup> / <sub>2</sub> "	1 <sup>3</sup> / <sub>4</sub> "	13"	1/4"	1,069.99
<b>NEW</b>	20	26"	011389605	023614071037	F, M, IC	3"	6 lbs. 2 oz.	45 <sup>3</sup> / <sub>4</sub> "	1 <sup>1</sup> / <sub>2</sub> "	1 <sup>3</sup> / <sub>4</sub> "	13"	1/4"	1,069.99
<b>NEW</b>	20	24"	011389606	023614071044	F, M, IC	3"	6 lbs.	43 <sup>3</sup> / <sub>4</sub> "	1 <sup>1</sup> / <sub>2</sub> "	1 <sup>3</sup> / <sub>4</sub> "	13"	1/4"	1,069.99

\*NOTE: Weights listed are approximate.



**SILVER HUNTER** ▶ GAUGE: 12 (SHOWN), 20 | SATIN FINISH STOCK AND FOREARM



**RECEIVER** - Strong, lightweight aluminum alloy  
 · Semi-humpback design · Silver finish  
**BARREL** - Lightweight profile · Ventilated rib  
**ACTION** - Gas-operated autoloader · 3" and 3½" chamber models  
 · Active Valve reliably cycles a wide range of loads  
**STOCK** - Satin finish walnut stock and forearm  
**FEATURES** - Three Invector-Plus™ choke tubes · Ivory front bead sight



**SILVER MICRO** ▶ GAUGE: 20 | SATIN FINISH STOCK AND FOREARM

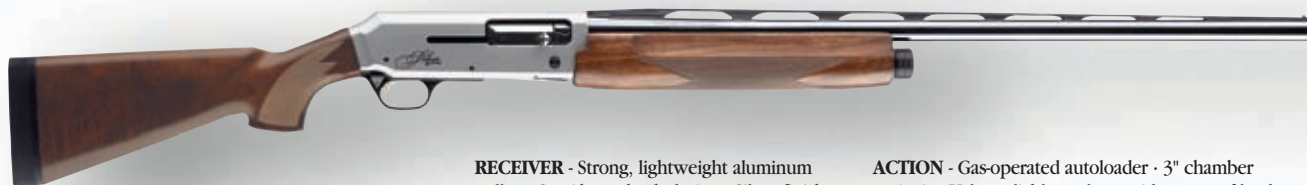

**RECEIVER** - Strong, lightweight aluminum alloy · Semi-humpback design · Silver finish  
**BARREL** - Lightweight profile  
 · Ventilated rib

**ACTION** - Gas-operated autoloader · 3" chamber  
 · Active Valve reliably cycles a wide range of loads  
**STOCK** - Satin finish walnut stock and forearm  
 · Compact stock dimensions fit smaller shooters  
**FEATURES** - Three Invector-Plus™ choke tubes  
 · Ivory front bead sight



**SILVER SPORTING MICRO** ▶ GAUGE: 12 | GLOSS FINISH STOCK AND FOREARM

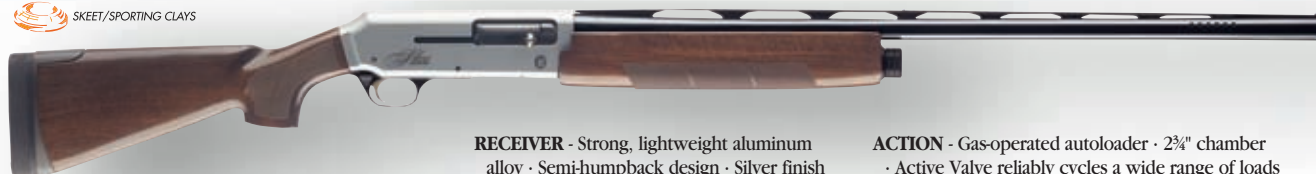

**RECEIVER** - Strong, lightweight aluminum alloy · Semi-humpback design · Silver finish  
**BARREL** - Lightweight profile  
 · Ventilated rib · Ported

**ACTION** - Gas-operated autoloader · 2¾" chamber  
 · Active Valve reliably cycles a wide range of loads  
**STOCK** - Gloss finish walnut stock and forearm  
 · Stock features ¾" length of pull adjustment in ¼" increments using the three included adjustment spacers · Premium Pachmayr® Decelerator® recoil pad  
**FEATURES** - Three Invector-Plus™ choke tubes  
 · Ivory front bead sight



GA.	BARREL LENGTH	CODE NUMBER	UPC #	CHOKES INCLUDED	CHAMBER	*AVG. WEIGHT	OVERALL LENGTH	DROP AT COMB	DROP AT HEEL	LENGTH OF PULL	RIB WIDTH	SUGG. RETAIL
<b>SILVER HUNTER</b>												
12	28"	011350204	023614251620	F, M, IC	3½"	7 lbs. 9 oz.	49"	1¾"	2"	14¼"	¼"	\$1,269.99
12	26"	011350205	023614251613	F, M, IC	3½"	7 lbs. 8 oz.	47"	1¾"	2"	14¼"	¼"	1,269.99
12	30"	011350303	023614250937	F, M, IC	3"	7 lbs. 6 oz.	51"	1¾"	2"	14¼"	¼"	1,069.99
12	28"	011350304	023614250920	F, M, IC	3"	7 lbs. 5 oz.	49"	1¾"	2"	14¼"	¼"	1,069.99
12	26"	011350305	023614250913	F, M, IC	3"	7 lbs. 4 oz.	47"	1¾"	2"	14¼"	¼"	1,069.99
20	28"	011350604	023614258742	F, M, IC	3"	6 lbs. 7 oz.	48¾"	1¾"	2¼"	14¼"	¼"	1,069.99
20	26"	011350605	023614258759	F, M, IC	3"	6 lbs. 5 oz.	46¾"	1¾"	2¼"	14¼"	¼"	1,069.99
<b>SILVER MICRO</b>												
20	26"	011375605	023614258766	F, M, IC	3"	6 lbs. 3 oz.	46"	1½"	1¾"	13⅝"	¼"	\$1,069.99
<b>SILVER SPORTING MICRO</b>												
12	28"	011373428	023614257783	F, M, IC	2¾"	7 lbs.	48"	1½"	1¾"	13⅝" Adj.	¼"	\$1,229.99

\*NOTE: Weights listed are approximate.



**SILVER SPORTING** ▶ GAUGE: 12 | GLOSS FINISH STOCK AND FOREARM



**RECEIVER** - Strong, lightweight aluminum alloy · Semi-humpback design · Silver finish  
**BARREL** - Lightweight profile · Ventilated rib · Ported  
**ACTION** - Gas-operated autoloader · 2¾" chamber · Active Valve reliably cycles a wide range of loads

**STOCK** - Gloss finish walnut stock and forearm · Stock features ¾" length of pull adjustment in ¼" increments using the three included adjustment spacers · Premium Pachmayr® Decelerator® recoil pad  
**FEATURES** - Three Invector-Plus™ choke tubes · HiViz® TriComp fiber-optic sight · Ivory mid-bead sight · Two Active Valve pistons included to optimize performance with light or heavy loads

**SILVER LIGHTNING FULL LINE DEALER** ▶ GAUGE: 12 | GLOSS FINISH STOCK AND FOREARM



**RECEIVER** - Aluminum alloy · Semi-humpback design · Silver finish  
**BARREL** - Lightweight profile · Ventilated rib

**ACTION** - Gas-operated autoloader · 3" and 3½" chamber models · Active Valve reliably cycles a wide range of loads  
**STOCK** - Gloss finish · Classic Lightning-style walnut stock  
**FEATURES** - Three Invector-Plus™ choke tubes · Ivory front bead sight · Available only from Browning Full Line and Medallion Dealers

**SILVER STALKER** ▶ GAUGE: 12 | DURA-TOUCH® ARMOR COATING ON STOCK AND FOREARM



**RECEIVER** - Aluminum alloy · Semi-humpback design  
**BARREL** - Lightweight profile · Ventilated rib

**ACTION** - Gas-operated autoloader · 3½" chamber · Active Valve reliably cycles a wide range of loads  
**STOCK** - Composite stock and forearm · Matte black finish · Dura-Touch® Armor Coating  
**FEATURES** - Three Invector-Plus™ choke tubes · Ivory front bead sight

GA.	BARREL LENGTH	CODE NUMBER	UPC #	CHOKES INCLUDED	CHAMBER	*AVG. WEIGHT	OVERALL LENGTH	DROP AT COMB	DROP AT HEEL	LENGTH OF PULL	RIB WIDTH	SUGG. RETAIL
<b>SILVER SPORTING</b>												
12	30"	011377427	023614065234	F, M, IC	2¾"	7 lbs. 9 oz.	50¾"	1½"	1¾"	14¼" Adj.	¼"	\$1,229.99
12	28"	011377428	023614065241	F, M, IC	2¾"	7 lbs. 8 oz.	48¾"	1½"	1¾"	14¼" Adj.	¼"	1,229.99
<b>SILVER LIGHTNING FULL LINE DEALER</b>												
12	28"	011368204	023614257264	F, M, IC	3½"	7 lbs. 9 oz.	49"	1¾"	2"	14¼"	¼"	\$1,299.99
12	26"	011368205	023614257257	F, M, IC	3½"	7 lbs. 8 oz.	47"	1¾"	2"	14¼"	¼"	1,299.99
12	28"	011368304	023614257240	F, M, IC	3"	7 lbs. 6 oz.	49"	1¾"	2"	14¼"	¼"	1,109.99
12	26"	011368305	023614257233	F, M, IC	3"	7 lbs. 4 oz.	47"	1¾"	2"	14¼"	¼"	1,109.99
<b>SILVER STALKER</b>												
12	28"	011351204	023614251644	F, M, IC	3½"	7 lbs. 9 oz.	49"	1¾"	2"	14¼"	¼"	\$1,219.99
12	26"	011351205	023614251637	F, M, IC	3½"	7 lbs. 8 oz.	47"	1¾"	2"	14¼"	¼"	1,219.99

\*NOTE: Weights listed are approximate.



**SILVER, MOSSY OAK® BREAK-UP® INFINITY™** ▶ GAUGE: 12 | DURA-TOUCH® ARMOR COATING ON STOCK AND FOREARM



**RECEIVER** - Aluminum alloy  
 · Semi-humpback design  
**BARREL** - Lightweight profile · Ventilated rib  
**ACTION** - Gas-operated autoloader · 3½" chamber · Active Valve reliably cycles a wide range of loads

**STOCK** - Composite stock and forearm  
 · Dura-Touch® Armor Coating  
 · Mossy Oak® Break-Up® Infinity™ camo finish  
**FEATURES** - Three Invector-Plus™ choke tubes · Ivory front bead sight

**SILVER, MOSSY OAK® DUCK BLIND®** ▶ GAUGE: 12 | DURA-TOUCH® ARMOR COATING ON STOCK AND FOREARM



**RECEIVER** - Aluminum alloy  
 · Semi-humpback design  
**BARREL** - Lightweight profile  
 · Ventilated rib

**ACTION** - Gas-operated autoloader · 3½" chamber  
 · Active Valve reliably cycles a wide range of loads  
**STOCK** - Composite stock and forearm  
 · Dura-Touch® Armor Coating  
 · Mossy Oak® Duck Blind® camo finish  
**FEATURES** - Three Invector-Plus™ choke tubes  
 · Ivory front bead sight

**SILVER NWTF, MOSSY OAK® BREAK-UP® INFINITY™** ▶ GAUGE: 12 | DURA-TOUCH® ARMOR COATING ON STOCK AND FOREARM



**RECEIVER** - Aluminum alloy  
 · Semi-humpback design  
 · NWTF model drilled and tapped for scope mounts  
**BARREL** - Lightweight profile  
 · Ventilated rib

**ACTION** - Gas-operated autoloader · 3" and 3½" chamber models · Active Valve reliably cycles a wide range of loads  
**STOCK** - Composite stock and forearm  
 · Dura-Touch® Armor Coating  
 · Mossy Oak® Break-Up® Infinity™ camo finish  
**FEATURES** - HiViz® 4-in-1 fiber-optic sight  
 · Three Invector-Plus™ choke tubes



**ULTIMATE CONCEALMENT**

Browning has a long-standing partnership with Mossy Oak® brand camouflage. Their cutting edge patterns offer three-dimensional realism for concealment that blends into nature better than any other camouflage brand.



GA.	BARREL LENGTH	CODE NUMBER	UPC #	CHOKES INCLUDED	CHAMBER	*AVG. WEIGHT	OVERALL LENGTH	DROP AT COMB	DROP AT HEEL	LENGTH OF PULL	RIB WIDTH	SUGG. RETAIL
<b>SILVER MOSSY OAK BREAK-UP INFINITY</b>												
12	26"	011384205	023614068921	F, M, IC	3½"	7 lbs. 8 oz.	47"	1¾"	2"	14¼"	¼"	\$1,359.99
<b>SILVER MOSSY OAK DUCK BLIND</b>												
12	28"	011366204	023614256151	F, M, IC	3½"	7 lbs. 9 oz.	49"	1¾"	2"	14¼"	¼"	\$1,359.99
12	26"	011366205	023614256144	F, M, IC	3½"	7 lbs. 8 oz.	47"	1¾"	2"	14¼"	¼"	1,359.99
<b>SILVER NWTF, MOSSY OAK BREAK-UP INFINITY</b>												
12	24"	011385206	023614068938	Full Str Trky, M, IC	3½"	7 lbs. 4 oz.	45"	1¾"	2"	14¼"	¼"	\$1,459.99
12	24"	011385306	023614068952	XF, M, IC	3"	7 lbs.	45"	1¾"	2"	14¼"	¼"	1,299.99

\*NOTE: Weights listed are approximate.



**SILVER RIFLED DEER, MOSSY OAK® BREAK-UP® INFINITY™** ▶ GAUGE: 12 (SHOWN), 20 | DURA-TOUCH® ARMOR COATING ON STOCK AND FOREARM



**RECEIVER** - Aluminum alloy  
 · Semi-humpback design  
**BARREL** - Thick-walled for slug ammunition only

**ACTION** - Gas-operated autoloader · 3" chamber  
 · Active Valve reliably cycles a wide range of loads  
**STOCK** - Composite stock and forearm · Dura-Touch® Armor Coating · Mossy Oak® Break-Up® Infinity™ camo finish  
**FEATURES** - Cantilever scope mount

**SILVER RIFLED DEER STALKER** ▶ GAUGE: 12 | DURA-TOUCH® ARMOR COATING ON STOCK AND FOREARM



**RECEIVER** - Aluminum alloy  
 · Semi-humpback design  
**BARREL** - Thick-walled for slug ammunition only

**ACTION** - Gas-operated autoloader · 3" chamber  
 · Active Valve reliably cycles a wide range of loads  
**STOCK** - Composite stock and forearm · Dura-Touch® Armor Coating · Matte black finish  
**FEATURES** - Cantilever scope mount

**SILVER RIFLED DEER SATIN** ▶ GAUGE: 20 | SATIN FINISH STOCK AND FOREARM



**RECEIVER** - Aluminum alloy  
 · Semi-humpback design  
**BARREL** - Thick-walled for slug ammunition only

**ACTION** - Gas-operated autoloader · 3" chamber  
 · Active Valve reliably cycles a wide range of loads  
**STOCK** - Satin finish walnut  
**FEATURES** - Cantilever scope mount (Scope and rings not included)

GA.	BARREL LENGTH	CODE NUMBER	UPC #	CHOKES INCLUDED	CHAMBER	*AVG. WEIGHT	OVERALL LENGTH	DROP AT COMB	DROP AT HEEL	LENGTH OF PULL	RATE OF TWIST	SUGG. RETAIL
<b>SILVER RIFLED DEER MOSSY OAK BREAK-UP INFINITY</b>												
12	22"	011386321	023614068945	Rif. Bbl./Cant.	3"	7 lbs. 12 oz.	43"	1¾"	2"	14¼"	1 in 28"	\$1,349.99
20	22"	011386621	023614068969	Rif. Bbl./Cant.	3"	6 lbs. 12 oz.	42¾"	1¾"	2¼"	14¼"	1 in 24"	1,349.99
<b>SILVER RIFLED DEER STALKER</b>												
12	22"	011351321	023614257776	Rif. Bbl./Cant.	3"	7 lbs. 12 oz.	43"	1¾"	2"	14¼"	1 in 28"	\$1,219.99
<b>SILVER RIFLED DEER SATIN</b>												
20	22"	011371621	023614065258	Rif. Bbl./Cant.	3"	6 lbs. 12 oz.	42¾"	1¾"	2¼"	14¼"	1 in 24"	\$1,269.99

\*NOTE: Weights listed are approximate.



**SILVER® EXTRA BARRELS**

MODEL	GA.	BARREL LENGTH	CODE NUMBER	UPC #	CHOKES INCLUDED	CHAMBER	RATE OF TWIST	SUGG. RETAIL
Hunter	12	28"	111350204	023614256175	F, M, IC	3½"	—	\$419.99
Hunter	12	26"	111350205	023614256168	F, M, IC	3½"	—	419.99
Hunter	12	30"	111350303	023614256205	F, M, IC	3"	—	339.99
Hunter	12	28"	111350304	023614256199	F, M, IC	3"	—	339.99
Hunter	12	26"	111350305	023614256182	F, M, IC	3"	—	339.99
Hunter/Micro*	20	28"	111350604	023614258803	F, M, IC	3"	—	339.99
Hunter/Micro*	20	26"	111350605	023614258810	F, M, IC	3"	—	339.99
Deer Satin	20	22"	111371621	023614068228	Rif. Bbl./Cant.	3"	1 in 24"	419.99
Stalker	12	28"	111351204	023614256229	F, M, IC	3½"	—	419.99
Stalker	12	26"	111351205	023614256212	F, M, IC	3½"	—	419.99
Deer MONBU**	12	22"	111379321	023614064473	Rif. Bbl./Cant.	3"	1 in 28"	539.99
Deer MOINF**	12	22"	111387321	023614069096	Rif. Bbl./Cant.	3"	1 in 28"	539.99
Deer Stalker**	12	22"	111380321	023614064480	Rif. Bbl./Cant.	3"	1 in 28"	459.99
MONBU	12	24"	111352206	023614258858	F, M, IC	3½"	—	439.99
MOINF	12	24"	111384206	023614069119	F, M, IC	3½"	—	439.99
MONBU	12	26"	111352205	023614256236	F, M, IC	3½"	—	439.99
MOINF	12	26"	111384205	023614069102	F, M, IC	3½"	—	439.99
MODB	12	28"	111366204	023614256250	F, M, IC	3½"	—	439.99
MODB	12	26"	111366205	023614256243	F, M, IC	3½"	—	439.99

\*20 gauge Silver shotgun barrels fit on Silver Hunter and Silver Micro 20 gauge models.

\*\*To prevent damage to forearms, all Silver rifled cantilever barrels are delivered with a new forearm specifically designed to fit over the thicker, rifled barrel walls.

**GOLD® EXTRA BARRELS**

MODEL	GA.	BARREL LENGTH	CODE NUMBER	UPC #	CHOKES INCLUDED	CHAMBER	RATE OF TWIST	SUGG. RETAIL
<b>GOLD 12 GAUGE CAMOUFLAGE EXTRA BARRELS</b>								
MONBU	12	24"	111116206	023614232407	XF Turkey	3½"	—	\$524.99
MONBU	12	22"	111116221	023614251132	Rif. Bbl./Cant.	3½"	1 in 28"	620.99
MONSG	12	26"	111117305	023614232889	F, M, IC	3"	—	432.99
<b>GOLD 12 &amp; 20 GAUGE EXTRA BARRELS</b>								
Deer Hunter	12	22"	111106220	023614235118	Rif. Bbl./Cant.	3½"	1 in 28"	\$503.99
Deer Hunter	12	22"	111106319	023614075202	Rif. Tube/Cant.	3"	1 in 28"	435.99
Fusion	20	28"	111141604	023614241744	F, M, IC	3"	—	480.99
Fusion	20	26"	111141605	023614241768	F, M, IC	3"	—	480.99
<b>GOLD 12 &amp; 20 GAUGE SUPERLITE HUNTER EXTRA BARRELS</b>								
SL Hunter	12	28"	111259204	023614251972	F, M, IC	3½"	—	\$492.99
SL Hunter	12	28"	111259304	023614252016	F, M, IC	3"	—	402.99
SL Hunter	12	26"	111259305	023614252023	F, M, IC	3"	—	402.99
SL Hunter	20	28"	111259604	023614252047	F, M, IC	3"	—	402.99
SL Hunter	20	26"	111259605	023614252054	F, M, IC	3"	—	402.99
<b>GOLD EVOLVE 12 GAUGE EXTRA BARRELS</b>								
Evolve Sporting	12	30"	111262427	023614252078	F, M, IC	2¾"	—	\$552.99
Evolve Sporting	12	28"	111262428	023614252061	F, M, IC	2¾"	—	552.99
Evolve	12	30"	111149303	023614252108	F, M, IC	3"	—	514.99
Evolve	12	28"	111149304	023614252092	F, M, IC	3"	—	514.99
Evolve	12	26"	111149305	023614252085	F, M, IC	3"	—	514.99
<b>GOLD 10 GAUGE EXTRA BARRELS</b>								
Hunter	10	28"	111101113	023614629634	F, M, IC	3½"	—	\$327.99
Hunter	10	26"	111101114	023614629641	F, M, IC	3½"	—	327.99
MONBU	10	28"	111137113	023614237204	F, M, IC	3½"	—	354.99
MOINF	10	28"	111280113	023614068976	F, M, IC	3½"	—	354.99
MONBU	10	26"	111137114	023614237211	F, M, IC	3½"	—	354.99
MOINF	10	26"	111280114	023614068983	F, M, IC	3½"	—	354.99
MONBU	10	24"	111137115	023614237228	XF Turkey	3½"	—	354.99
MOINF	10	24"	111280115	023614068990	XF Turkey	3½"	—	354.99
MODB	10	28"	111270113	023614256120	F, M, IC	3½"	—	354.99
MODB	10	26"	111270114	023614256137	F, M, IC	3½"	—	354.99



Mossy Oak Break-Up Infinity camo will be offered in conjunction with New Break-Up camo on select Browning extra barrels.

**IMPORTANT: DO NOT ATTEMPT THE USE OF 3½" CHAMBERED BARRELS WITH 3" RECEIVERS NOR 3" CHAMBERED BARRELS WITH 3½" RECEIVERS.**



**HARD-HITTING 10 GAUGE SHOTGUNS.**

When hard-hitting punch and reliable performance are all that matter in your shotgun, there is nothing better than a 10 gauge. Our BPS® pump and Gold® autoloading 10 gauge shotguns are waiting to meet your needs.



**GOLD® LIGHT 10 GAUGE** ▶ GAUGE: 10 | DURA-TOUCH® ARMOR COATING ON STOCK AND FOREARM

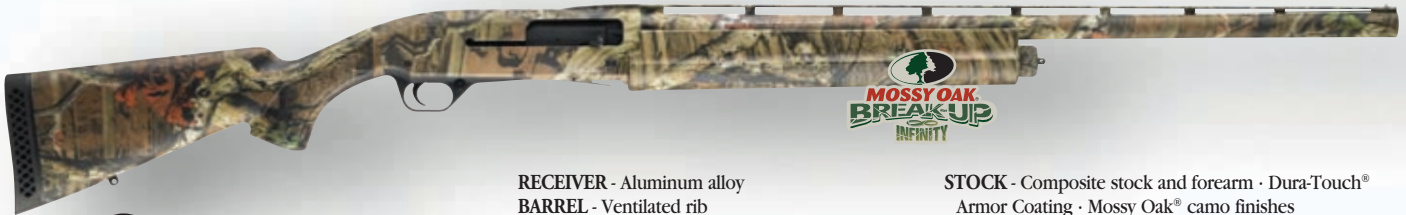

**DURA-TOUCH®**  
Armor Coating



RECEIVER - Aluminum alloy  
 BARREL - Ventilated rib  
 ACTION - Gas-operated autoloader · 3½" chamber  
 MAGAZINE CAPACITY - Four in the magazine plus one in the chamber

STOCK - Composite stock and forearm · Dura-Touch® Armor Coating · Mossy Oak® camo finishes  
 FEATURES - Three Standard Invector™ choke tubes · NWTF model includes HiViz® 4-in-1 fiber-optic sight

**BPS® 10 GAUGE** ▶ GAUGE: 10 | NON-GLARE COMPOSITE FINISH ON STOCK AND FOREARM

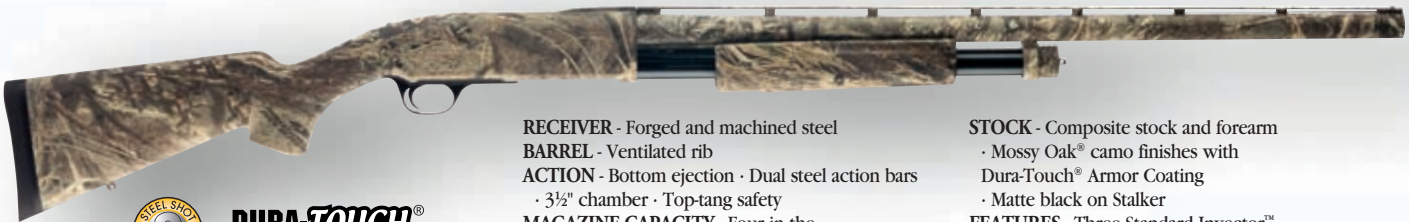

**DURA-TOUCH®**  
Armor Coating

RECEIVER - Forged and machined steel  
 BARREL - Ventilated rib  
 ACTION - Bottom ejection · Dual steel action bars · 3½" chamber · Top-tang safety  
 MAGAZINE CAPACITY - Four in the magazine plus one in the chamber

STOCK - Composite stock and forearm · Mossy Oak® camo finishes with Dura-Touch® Armor Coating · Matte black on Stalker  
 FEATURES - Three Standard Invector™ choke tubes · Brass front bead sight

**NWTF BPS® 10 GAUGE, MOSSY OAK® BREAK-UP® INFINITY™** ▶ GAUGE: 10 | DURA-TOUCH® ARMOR COATING ON STOCK AND FOREARM



**DURA-TOUCH®**  
Armor Coating



RECEIVER - Forged and machined steel · NWTF drilled and tapped for scope mounts  
 BARREL - Ventilated rib · 24" length  
 ACTION - Bottom ejection · Dual steel action bars · 3½" chamber · Top-tang safety  
 MAGAZINE CAPACITY - Four in the magazine plus one in the chamber  
 STOCK - Composite stock and forearm · Dura-Touch® Armor Coating · Mossy Oak® Break-Up® Infinity™ camo finish · NWTF® logo

FEATURES - Standard Invector™ X-Full Turkey choke tube · HiViz® 4-in-1 fiber-optic sight · Endorsed by the National Wild Turkey Federation

	GA.	BARREL LENGTH	CODE NUMBER	UPC #	CHOKES INCLUDED	CHAMBER	*AVG. WEIGHT	OVERALL LENGTH	DROP AT COMB	DROP AT HEEL	LENGTH OF PULL	RIB WIDTH	SUGG. RETAIL	
<b>GOLD LIGHT 10 GAUGE, MOSSY OAK BREAK-UP INFINITY (SHOWN) AND MOSSY OAK DUCK BLIND WITH DURA-TOUCH</b>														
	MOINF	10	28"	011280113	023614068907	F, M, IC	3½"	9 lbs. 10 oz.	50"	1½"	2½"	14½"	5/16"	\$1,639.99
	MOINF	10	26"	011280114	023614068891	F, M, IC	3½"	9 lbs. 9 oz.	48"	1½"	2½"	14½"	5/16"	1,639.99
	NWTF/MOINF	10	24"	011281115	023614068914	XF Turkey	3½"	9 lbs. 4 oz.	46"	1½"	2½"	14½"	5/16"	1,779.99
	MODB	10	28"	011270113	023614256038	F, M, IC	3½"	9 lbs. 10 oz.	50"	1½"	2½"	14½"	5/16"	1,639.99
	MODB	10	26"	011270114	023614256021	F, M, IC	3½"	9 lbs. 9 oz.	48"	1½"	2½"	14½"	5/16"	1,639.99
<b>BPS 10 GAUGE STALKER</b>														
	Stalker	10	28"	012212113	023614076315	F, M, IC	3½"	10 lbs. 9 oz.	50"	1½"	2½"	14¼"	5/16"	\$719.99
	Stalker	10	26"	012212114	023614076322	F, M, IC	3½"	10 lbs. 8 oz.	48"	1½"	2½"	14¼"	5/16"	719.99
<b>BPS 10 GAUGE, MOSSY OAK BREAK-UP INFINITY AND MOSSY OAK DUCK BLIND (SHOWN) WITH DURA-TOUCH</b>														
	MOINF	10	28"	012257113	023614068808	F, M, IC	3½"	10 lbs. 9 oz.	50"	1½"	2½"	14¼"	5/16"	\$859.99
	MOINF	10	26"	012257114	023614068792	F, M, IC	3½"	10 lbs. 8 oz.	48"	1½"	2½"	14¼"	5/16"	859.99
	MODB	10	28"	012243113	023614255970	F, M, IC	3½"	10 lbs. 9 oz.	50"	1½"	2½"	14¼"	5/16"	859.99
	MODB	10	26"	012243114	023614255963	F, M, IC	3½"	10 lbs. 8 oz.	48"	1½"	2½"	14¼"	5/16"	859.99
<b>NWTF BPS 10 GAUGE, MOSSY OAK BREAK-UP INFINITY WITH DURA-TOUCH</b>														
	MOINF	10	24"	012258115	023614068785	XF Turkey	3½"	10 lbs. 3 oz.	46"	1½"	2½"	14¼"	5/16"	\$919.99

\*NOTE: Weights listed are approximate.





## BPS® EVERYTHING YOU NEED IN A SHOTGUN ... AND MORE.

You won't find a more rugged, faster handling pump shotgun than the stalwart Browning BPS. The BPS has proven itself reliable in the rain, snow, dust and mud. They've seen tough duty in marshes, cornfields and on trap ranges. Through it all, count on the BPS to load and eject shells with ease in spite of the conditions.

# BPS

## TOTAL BARREL DYNAMICS

### BACK-BORED BARREL TECHNOLOGY

We were the first manufacturer to recognize the advantages of a back-bored barrel. Back-boring increases the bore diameter to reduce friction between the shot cup and the bore to maximize shot velocity and reduce felt recoil. Through intense research, our back-bore specifications have been perfected and represent the ideal bore diameter needed to minimize shot deformation and maximize pattern uniformity, consistency and density. Any larger and gases slip by the shot cup, resulting in reduced pellet velocity and blown patterns. Any smaller, and the forcing cone will deform pellets and result in poor ballistic performance, fliers and uneven, spotty pellet coverage on the target.

### INVECTOR™ CHOKE TUBE SYSTEMS

The proven Invector™ (28 gauge, .410 bore) and Invector-Plus™ (12, 20 gauge) interchangeable choke tube systems come on every BPS shotgun for consistent, dense shot patterns in just the constriction needed for your shooting situation. The longer choke taper inside an Invector-Plus choke tube works hand-in-hand with Back-Bored Technology to produce consistent patterns with more uniform densities and fewer fliers. The superior design of the Invector systems are far more durable than the choke systems found in competitors' guns, especially when shooting steel shot loads. The Invector systems eliminate gases slipping between the choke tube and barrel that could damage the choke tube and the barrel. See pages 146 to 149 for a complete listing of choke tubes.

### BACK-BORED TECHNOLOGY

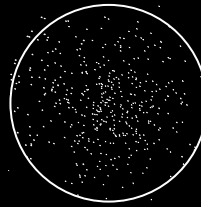

*Browning pattern with Back-Bored Technology*

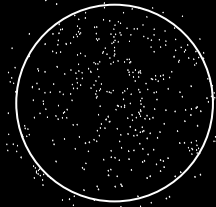

*The competitors' pattern without Back-Bored Technology*



### STEEL SHOT PERFORMANCE

The strength of a Browning barrel is legendary, and built to handle the punishment of steel shot. Unlike some manufacturers' barrels whose guns face an uncertain future after shooting steel, we have long been at the forefront of dependable steel shot performance and durability. Our barrels meet the strictest material and construction quality standards. The barrel blanks are made from rolled and tempered steel bars and are stress relieved to offer exceptional mechanical properties. The barrel blanks are then precision drilled, reamed and honed to exacting specifications. With proper care, Browning BPS barrels will last a lifetime.





### BOTTOM EJECTION AND LOADING

Unique bottom ejection provides operating convenience by throwing empty shells straight down, out of your line of sight, making the BPS the best pump shotgun choice for both right- and left-handed shooters.



### SAFETY

The thumb-operated, top-tang safety on the BPS can easily be operated with the right or left hand, even with gloved fingers.

### MAGAZINE CAPACITY

2¾": Four in magazine, one in chamber.  
 3": Three in magazine, one in chamber.  
 3½": Three in magazine, one in chamber.  
 (A three-shot magazine adapter plug is included.)



### MAXIMUM GRIP

Camo composite BPS models combine in-molded checkered gripping surfaces and our proven Dura-Touch® Armor Coating for a sure hold and a sleek feel in all climate conditions.



### RELIABLE PUMP-ACTION

The proven pump-action design of the BPS is sound and reliable. All components are durably constructed of solid steel and housed inside a receiver machined from a solid block of forged steel. Rigid double slide bars are made from heat-treated steel and eliminate twisting and binding for faster, more efficient operation. The BPS offers smooth operation in all conditions and gives you the ability to stay on target while delivering rapid follow-up shots. A convenient serrated slide release is located at the rear of the trigger guard.



**BPS HUNTER** ▶ GAUGE: 12 (SHOWN), 16, 20, 28, .410 | SATIN FINISH STOCK AND FOREARM



**RECEIVER** - Forged and machined steel  
**BARREL** - Ventilated rib  
**ACTION** - Bottom ejection · Dual steel action bars · Top-tang safety

**STOCK** - Satin finish walnut  
**FEATURES** - Three Invector-Plus™ choke tubes with 12 and 20 · Three Standard Invector™ with 16, 28 and .410 · Recoil pad on 12 gauge model · Brass front bead sight



**BPS UPLAND SPECIAL** ▶ GAUGE: 12, 16, 20 (SHOWN) | SATIN FINISH STOCK AND FOREARM

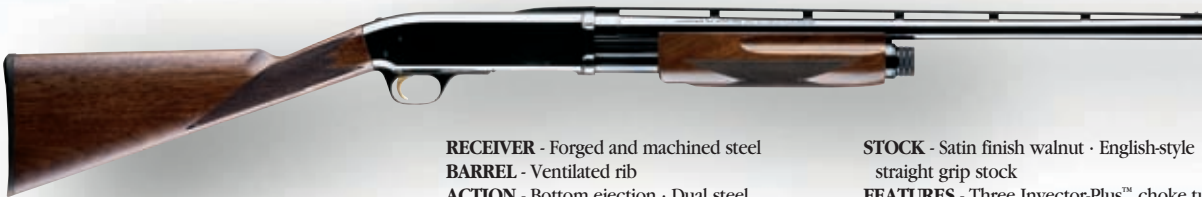

**RECEIVER** - Forged and machined steel  
**BARREL** - Ventilated rib  
**ACTION** - Bottom ejection · Dual steel action bars · Top-tang safety

**STOCK** - Satin finish walnut · English-style straight grip stock  
**FEATURES** - Three Invector-Plus™ choke tubes with 12 and 20 · Three Standard Invector™ with 16 · Brass front bead sight



**BPS MICRO** ▶ GAUGE: 20 | SATIN FINISH STOCK AND FOREARM



*BPS Micro*

**RECEIVER** - Forged and machined steel  
**BARREL** - Compact 22" length · Ventilated rib  
**ACTION** - Bottom ejection · Dual steel action bars · Top-tang safety  
**STOCK** - Satin finish walnut · Compact dimensions to suit smaller shooters  
**FEATURES** - Three Invector-Plus™ choke tubes · Brass front bead sight



*BPS Mossy Oak® Duck Blind®*

GA.	BARREL LENGTH	CODE NUMBER	UPC #	CHOKES INCLUDED	CHAMBER	*AVG. WEIGHT	OVERALL LENGTH	DROP AT COMB	DROP AT HEEL	LENGTH OF PULL	RIB WIDTH	SUGG. RETAIL
<b>BPS HUNTER</b>												
12	28"	012211304	023614076209	F, M, IC	3"	7 lbs. 11 oz.	48¾"	1½"	1½"	14¼"	⅜"	\$619.99
12	26"	012211305	023614076216	F, M, IC	3"	7 lbs. 10 oz.	46¾"	1½"	1½"	14¼"	⅜"	619.99
16	28"	012211513	023614256649	F, M, IC	2¾"	7 lbs. 2 oz.	48¾"	1½"	1½"	14¼"	⅜"	659.99
16	26"	012211514	023614256632	F, M, IC	2¾"	7 lbs. 1 oz.	46¾"	1½"	1½"	14¼"	⅜"	659.00
20	28"	012211604	023614077107	F, M, IC	3"	7 lbs. 1 oz.	48¾"	1½"	1½"	14¼"	⅜"	619.99
20	26"	012211605	023614077060	F, M, IC	3"	7 lbs.	46¾"	1½"	1½"	14¼"	⅜"	619.99
28	28"	012211813	023614076223	F, M, IC	2¾"	7 lbs.	48¾"	1½"	1½"	14¼"	⅜"	659.99
28	26"	012211814	023614076230	F, M, IC	2¾"	6 lbs. 15 oz.	46¾"	1½"	1½"	14¼"	⅜"	659.99
.410	26"	012211914	023614235071	F, M, IC	3"	7 lbs.	46¾"	1½"	1½"	14¼"	⅜"	659.99
<b>BPS UPLAND SPECIAL</b>												
12	22"	012216307	023614077244	F, M, IC	3"	7 lbs. 8 oz.	42½"	1½"	1½"	14"	⅜"	\$619.00
16	26"	012216514	023614256656	F, M, IC	2¾"	6 lbs. 13 oz.	46½"	1½"	1½"	14"	⅜"	659.00
16	24"	012216515	023614256663	F, M, IC	2¾"	6 lbs. 12 oz.	44½"	1½"	1½"	14"	⅜"	659.00
20	22"	012216607	023614077268	F, M, IC	3"	6 lbs. 11 oz.	42½"	1½"	1½"	14"	⅜"	619.00
<b>BPS MICRO</b>												
20	22"	012225607	023614236900	F, M, IC	3"	6 lbs. 14 oz.	41¾"	1½"	1½"	13¾"	⅜"	\$619.00

\*NOTE: Weights listed are approximate.



**BPS RIFLED DEER HUNTER** ▶ GAUGE: 12 (SHOWN), 20 | SATIN FINISH STOCK AND FOREARM



**RECEIVER** - Forged and machined steel  
**BARREL** - Thick-walled for slug ammunition only · Rifled, 12 gauge: 1 in 28" twist, 20 gauge: 1 in 24" twist

**ACTION** - Bottom ejection · Dual steel action bars · Top-tang safety  
**STOCK** - Satin finish walnut  
**FEATURES** - Cantilever scope mount

**BPS, MOSSY OAK® BREAK-UP® INFINITY™** ▶ GAUGE: 12 | DURA-TOUCH® ARMOR COATING ON STOCK AND FOREARM



**RECEIVER** - Forged and machined steel · NWTF® model is drilled and tapped for scope mounts  
**BARREL** - Ventilated rib  
**ACTION** - Bottom ejection · Dual steel action bars · Top-tang safety

**STOCK** - Composite stock and forearm · Dura-Touch® Armor Coating · Mossy Oak® Break-Up® Infinity™ camo finish  
**FEATURES** - Three Invector-Plus™ choke tubes · NWTF® models include the HiViz® 4-in-1 fiber-optic sight and buttstock decal



**BPS, MOSSY OAK® DUCK BLIND®** ▶ GAUGE: 12 | DURA-TOUCH® ARMOR COATING ON STOCK AND FOREARM



**RECEIVER** - Forged and machined steel  
**BARREL** - Ventilated rib  
**ACTION** - Bottom ejection · Dual steel action bars · Top-tang safety  
**STOCK** - Composite stock and forearm · Dura-Touch® Armor Coating · Mossy Oak® Duck Blind® camo finish  
**FEATURES** - Three Invector-Plus™ choke tubes · Brass front bead sight



	GA.	BARREL LENGTH	CODE NUMBER	UPC #	CHOKES INCLUDED	CHAMBER	*AVG. WEIGHT	OVERALL LENGTH	DROP AT COMB	DROP AT HEEL	LENGTH OF PULL	RIB WIDTH	RATE OF TWIST	SUGG. RETAIL
<b>BPS RIFLED DEER HUNTER</b>														
	12	22"	012214324	023614075073	Rif. Bbl./Cant.	3"	7 lbs. 10 oz.	42½"	1½"	2½"	13¾"	—	1 in 28"	\$749.99
	20	22"	012214624	023614255192	Rif. Bbl./Cant.	3"	7 lbs. 4 oz.	42¼"	1½"	1½"	13¾"	—	1 in 24"	759.99
<b>BPS MOSSY OAK BREAK-UP INFINITY</b>														
	12	28"	012257204	023614068839	F, M, IC	3½"	8 lbs. 5 oz.	49¼"	1½"	2½"	14¼"	⅝"	—	\$859.99
	12	26"	012257205	023614068822	F, M, IC	3½"	8 lbs. 4 oz.	47¼"	1½"	2½"	14¼"	⅝"	—	859.99
NWTF	12	24"	012258206	023614068815	XF Trky, M, IC	3½"	8 lbs. 3 oz.	45¼"	1½"	2½"	14¼"	⅝"	—	919.99
	12	28"	012257304	023614068860	F, M, IC	3"	8 lbs. 1 oz.	48¾"	1½"	2½"	14¼"	⅝"	—	719.99
	12	26"	012257305	023614068853	F, M, IC	3"	8 lbs.	46¾"	1½"	2½"	14¼"	⅝"	—	719.99
NWTF	12	24"	012258306	023614068846	XF Trky, M, IC	3"	7 lbs. 15 oz.	44¾"	1½"	2½"	14¼"	⅝"	—	759.99
<b>BPS MOSSY OAK DUCK BLIND</b>														
	12	28"	012243204	023614255994	F, M, IC	3½"	8 lbs. 5 oz.	49¼"	1½"	2½"	14¼"	⅝"	—	\$859.99
	12	26"	012243205	023614255987	F, M, IC	3½"	8 lbs. 4 oz.	47¼"	1½"	2½"	14¼"	⅝"	—	859.99
	12	28"	012243304	023614256014	F, M, IC	3"	8 lbs. 1 oz.	48¾"	1½"	2½"	14¼"	⅝"	—	719.99
	12	26"	012243305	023614256007	F, M, IC	3"	8 lbs.	46¾"	1½"	2½"	14¼"	⅝"	—	719.99

\*NOTE: Weights listed are approximate.



**BPS RIFLED DEER, MOSSY OAK® BREAK-UP® INFINITY™** ▶ GAUGE: 12, 20 | DURA-TOUCH® ARMOR COATING ON STOCK AND FOREARM



BPS Rifled Deer, 12 gauge

**DURA-TOUCH®**  
Armor Coating



BPS Rifled Deer, 20 gauge

**DURA-TOUCH®**  
Armor Coating



**RECEIVER** - Forged and machined steel  
**BARREL** - Thick-walled for slug ammunition only · Rifled, 12 gauge: 1 in 28" twist, 20 gauge: 1 in 24" twist  
**ACTION** - Bottom ejection · Dual steel action bars · Top-tang safety

**STOCK** - 12 gauge: composite stock and forearm, 20 gauge: wood stock and forearm · Dura-Touch® Armor Coating · Mossy Oak® Break-Up® Infinity™ camo finish  
**FEATURES** - Cantilever scope mount

**BPS STALKER** ▶ GAUGE: 12 | NON-GLARE COMPOSITE FINISH STOCK AND FOREARM

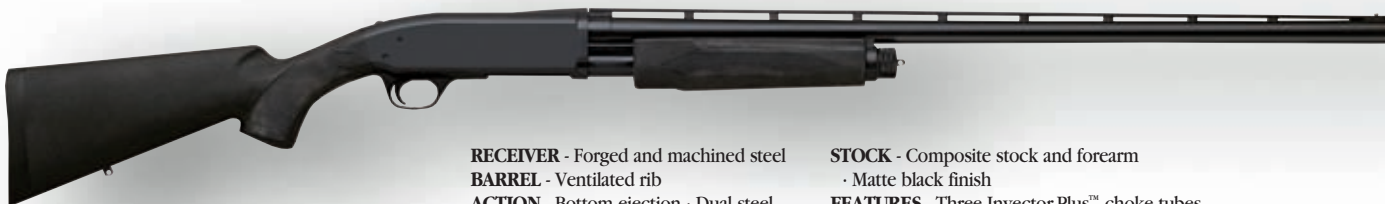

**RECEIVER** - Forged and machined steel  
**BARREL** - Ventilated rib  
**ACTION** - Bottom ejection · Dual steel action bars · Top-tang safety

**STOCK** - Composite stock and forearm · Matte black finish  
**FEATURES** - Three Invector-Plus™ choke tubes · Brass front bead sight





**BPS TRAP** ▶ GAUGE: 12 | SATIN FINISH STOCK AND FOREARM



Magazine cut-off

**RECEIVER** - Engraved · Forged and machined steel · Highly polished blue finish

**BARREL** - Ventilated rib

**ACTION** - Bottom ejection · Dual steel action bars · Top-tang safety

**STOCK** - Satin finish walnut · Raised comb

**FEATURES** - Magazine cut-off · Three Invector-Plus™ choke tubes · HiViz® ProComp fiber-optic sight with mid-bead

**BPS MICRO TRAP** ▶ GAUGE: 12 | SATIN FINISH STOCK AND FOREARM



Magazine cut-off

**RECEIVER** - Engraved · Forged and machined steel · Highly polished blue finish

**BARREL** - Ventilated rib

**ACTION** - Bottom ejection · Dual steel action bars · Top-tang safety

**STOCK** - Satin finish walnut · Raised comb

· Compact stock dimensions to fit smaller shooters

**FEATURES** - Magazine cut-off · Three Invector-Plus™ choke tubes · HiViz® ProComp fiber-optic sight with mid-bead

GA.	BARREL LENGTH	CODE NUMBER	UPC #	CHOKES INCLUDED	CHAMBER	*AVG. WEIGHT	OVERALL LENGTH	DROP AT COMB	DROP AT HEEL	LENGTH OF PULL	RIB WIDTH	WHOLESALE	SUGG. RETAIL
<b>BPS RIFLED DEER, MOSSY OAK BREAK-UP INFINITY</b>													
12	22"	012259324	023614068877	Rif. Bbl./Cant.	3"	7 lbs. 10 oz.	42½"	1½"	2½"	14¾"	—	\$579.00	\$779.99
20	22"	012259624	023614068884	Rif. Bbl./Cant.	3"	7 lbs. 5 oz.	42¼"	1½"	1½"	14¾"	—	669.00	899.99
<b>BPS STALKER</b>													
12	30"	012212303	023614076117	F, M, IC	3"	8 lbs. 2 oz.	50¾"	1½"	2½"	14¾"	⅝"	\$439.00	\$589.99
12	28"	012212304	023614075912	F, M, IC	3"	8 lbs. 1 oz.	48¾"	1½"	2½"	14¾"	⅝"	439.00	589.99
12	26"	012212305	023614075929	F, M, IC	3"	8 lbs.	46¾"	1½"	2½"	14¾"	⅝"	439.00	589.99
12	28"	012212204	023614075899	F, M, IC	3½"	8 lbs. 5 oz.	49¾"	1½"	2½"	14¾"	⅝"	\$539.00	719.99
12	26"	012212205	023614075905	F, M, IC	3½"	8 lbs. 4 oz.	47¼"	1½"	2½"	14¾"	⅝"	539.00	719.99
<b>BPS TRAP</b>													
12	30"	012242403	023614255819	F, IM, M	2¾"	8 lbs. 6 oz.	51"	1½"	2"	14¾"	⅝"	\$579.00	\$779.99
<b>BPS MICRO TRAP</b>													
12	28"	012241404	023614255802	F, IM, M	2¾"	8 lbs. 1 oz.	48¼"	1½"	2"	13¾"	⅝"	\$579.00	\$779.99

\*NOTE: Weights listed are approximate.

**BROWNING GROWTH INSURANCE PROGRAM**

It's a fact, kids grow. Which makes purchasing a firearm for them a difficult decision. Should you buy an inexpensive "youth" model with questionable quality that they will soon grow out of? Or should you buy a well-made, but ill-fitting, full-size firearm that won't let them shoot to their potential because of poor fit? Fortunately, Browning offers the perfect solution for both now and later with the Growth Insurance Program. For a limited time, with the purchase of a new Browning Micro Midas or Micro firearm, you are eligible to purchase a full-size stock at 50% off the retail price. That's a big savings for you, and allows them to enjoy a firearm of the highest quality that is sure to fit and maximize their shooting performance and enjoyment for years to come. Visit [browning.com](http://browning.com) for complete details.





**BPS® EXTRA BARRELS**

MODEL	GA.	BARREL LENGTH	CODE NUMBER	UPC #	CHOKES INCLUDED	CHAMBER	FEATURES	RATE OF TWIST	SUGG. RETAIL
<b>BPS 10 GAUGE EXTRA BARRELS</b>									
Hunter	10	28"	111211113	023614077220	F, M, IC	3½"	—	—	\$309.99
Hunter	10	26"	111211114	023614077237	F, M, IC	3½"	—	—	309.99
Hunter	10	24"	111211115	023614232735	F, M, IC	3½"	—	—	309.99
Stalker	10	28"	111212113	023614076476	F, M, IC	3½"	—	—	309.99
Stalker	10	26"	111212114	023614076483	F, M, IC	3½"	—	—	309.99
Stalker	10	24"	111212115	023614232773	F, M, IC	3½"	—	—	309.99
MONSG	10	28"	111220113	023614232766	F, M, IC	3½"	—	—	339.99
MONSG	10	26"	111220114	023614232759	F, M, IC	3½"	—	—	339.99
MONSG	10	24"	111220115	023614232742	F, M, IC	3½"	—	—	339.99
MONBU	10	28"	111219113	023614235224	F, M, IC	3½"	—	—	339.99
MOINF	10	28"	111257113	023614069003	F, M, IC	3½"	—	—	339.99
MONBU	10	26"	111219114	023614235231	F, M, IC	3½"	—	—	339.99
MOINF	10	26"	111257114	023614069010	F, M, IC	3½"	—	—	339.99
MONBU	10	24"	111219115	023614235248	XF Turkey	3½"	—	—	339.99
MOINF	10	24"	111257115	023614069027	XF Turkey	3½"	—	—	339.99
MODB	10	28"	111243113	023614256045	F, M, IC	3½"	—	—	339.99
MODB	10	26"	111243114	023614256052	F, M, IC	3½"	—	—	339.99
<b>BPS 12 GAUGE EXTRA CAMOUFLAGE BARRELS</b>									
MONBU	12	28"	111219204	023614235194	F, M, IC	3½"	—	—	\$339.99
MOINF	12	28"	111257204	023614069034	F, M, IC	3½"	—	—	339.99
MONBU	12	26"	111219205	023614235200	F, M, IC	3½"	—	—	339.99
MOINF	12	26"	111257205	023614069041	F, M, IC	3½"	—	—	339.99
MONBU	12	24"	111219206	023614235217	XF Turkey	3½"	—	—	339.99
MOINF	12	24"	111257206	023614069058	XF Turkey	3½"	—	—	339.99
MONSG	12	28"	111220204	023614233008	F, M, IC	3½"	—	—	339.99
MONSG	12	26"	111220205	023614232995	F, M, IC	3½"	—	—	339.99
MONSG	12	24"	111220206	023614232988	F, M, IC	3½"	—	—	339.99
MODB	12	28"	111243204	023614256069	F, M, IC	3½"	—	—	339.99
MODB	12	26"	111243205	023614256076	F, M, IC	3½"	—	—	339.99
MONBU	12	28"	111219304	023614235163	F, M, IC	3"	—	—	299.99
MOINF	12	28"	111257304	023614069065	F, M, IC	3"	—	—	299.99
MONBU	12	26"	111219305	023614235170	F, M, IC	3"	—	—	299.99
MOINF	12	26"	111257305	023614069072	F, M, IC	3"	—	—	299.99
MONBU	12	24"	111219306	023614235187	XF Turkey	3"	—	—	299.99
MOINF	12	24"	111257306	023614069089	XF Turkey	3"	—	—	299.99
MONSG	12	28"	111220304	023614232827	F, M, IC	3"	—	—	299.99
MONSG	12	26"	111220305	023614232810	F, M, IC	3"	—	—	299.99
MONSG	12	24"	111220306	023614232803	F, M, IC	3"	—	—	299.99
MODB	12	28"	111243304	023614256090	F, M, IC	3"	—	—	299.99
MODB	12	26"	111243305	023614256106	F, M, IC	3"	—	—	299.99
<b>BPS 12 GAUGE, 16 GAUGE, 20 GAUGE, 28 GAUGE &amp; .410 BORE EXTRA BARRELS</b>									
Hunter	12	28"	111211204	023614076339	F, M, IC	3½"	—	—	\$309.99
Hunter	12	26"	111211205	023614076346	F, M, IC	3½"	—	—	309.99
Hunter	12	24"	111211206	023614232056	F, M, IC	3½"	—	—	309.99
Hunter	12	28"	111211304	023614076384	F, M, IC	3"	—	—	269.99
Hunter	12	26"	111211305	023614076391	F, M, IC	3"	—	—	269.99
Hunter	12	24"	111211306	023614232780	F, M, IC	3"	—	—	269.99
Hunter	16	28"	111211513	023614259527	F, M, IC	2¾"	—	—	269.99
Hunter	16	26"	111211514	023614259510	F, M, IC	2¾"	—	—	269.99
Hunter	20	28"	111211604	023614077190	F, M, IC	3"	—	—	269.99
Hunter	20	26"	111211605	023614232087	F, M, IC	3"	—	—	269.99
Hunter	20	22"	111211607	023614243922	F, M, IC	3"	—	—	269.99
Hunter	28	28"	111211813	023614076452	F, M, IC	2¾"	—	—	269.99
Hunter	28	26"	111211814	023614076469	F, M, IC	2¾"	—	—	269.99
Hunter	410	26"	111211914	023614235330	F, M, IC	3"	—	—	269.99
Stalker	12	28"	111212204	023614076353	F, M, IC	3½"	—	—	309.99
Stalker	12	26"	111212205	023614076360	F, M, IC	3½"	—	—	309.99
Stalker	12	24"	111212206	023614232063	F, M, IC	3½"	—	—	309.99
Stalker	12	30"	111212303	023614076407	F, M, IC	3"	—	—	269.99
Stalker	12	28"	111212304	023614076414	F, M, IC	3"	—	—	269.99
Stalker	12	26"	111212305	023614076421	F, M, IC	3"	—	—	269.99
Stalker	12	24"	111212306	023614232797	F, M, IC	3"	—	—	269.99
Upland Special	12	22"	111216307	023614243984	F, M, IC	3"	—	—	269.99
<b>BPS GAME GUN EXTRA BARRELS</b>									
Deer Special	12	22"	111214221	023614239246	Rif. Bbl./Cant.	3½"	Satin, Cantilever scope mount	1 in 28"	\$439.99
Deer Special	20	22"	111214621	023614240334	Rif. Bbl./Cant.	3"	Satin, Cantilever scope mount	1 in 24"	399.99
Deer Special	12	22"	111214324	023614075134	Rif. Bbl./Cant.	3"	Satin, Cantilever scope mount	1 in 28"	399.99
Turkey Special	12	20½"	111215323	023614076445	XF Turkey	3"	Satin, with Sight	—	319.99
Turkey Special	12	20½"	111215223	023614235514	XF Turkey	3½"	Satin, with Sight	—	359.99



Mossy Oak Break-Up Infinity camo will be offered in conjunction with New Break-Up camo on select Browning extra barrels.

**IMPORTANT: DO NOT ATTEMPT THE USE OF 3½" CHAMBERED BARRELS WITH 3" RECEIVERS NOR 3" CHAMBERED BARRELS WITH 3½" RECEIVERS.**



# X-BOLT™

**TOTAL ACCURACY.** There are scores of bolt-action rifles available, yet none match the Browning X-Bolt in terms of innovative features, quality and straight-from-the-box accuracy. Unlike competitors' rifles, the X-Bolt is designed as an integrated system of features that come together to deliver the most important aspect of any rifle — total, dependable, pinpoint accuracy.

**60° BOLT LIFT** Short 60° bolt lift is fast cycling and allows you to work the bolt quickly without the scope getting in the way. The bolt is machined from solid steel bar stock for strength and custom rifle precision. Three locking lugs provide exceptional bolt strength.



**BOLT UNLOCK BUTTON** Conveniently located on top of the bolt handle, the bolt unlock button allows the bolt to be unlocked and opened with the safety in the on safe position. The bolt unlock button works in conjunction with the top-tang safety to provide an extra margin of safety when checking and unloading the chamber. The safety blocks the trigger sear and features a firing pin block for added security.

## FEATHERTRIGGER™

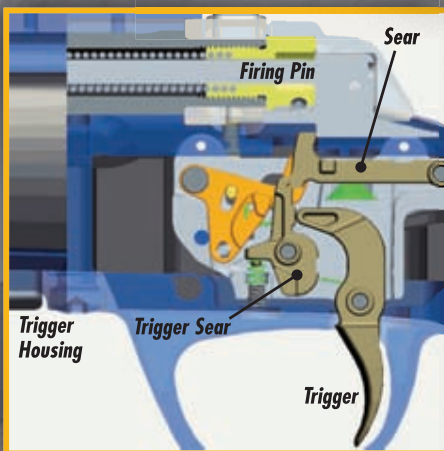

Full sear engagement (Ready to fire)

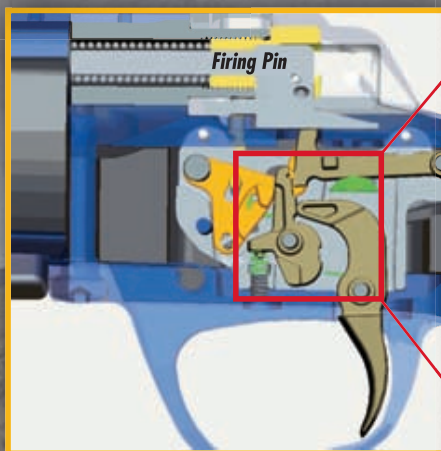

Unseared (Fired)

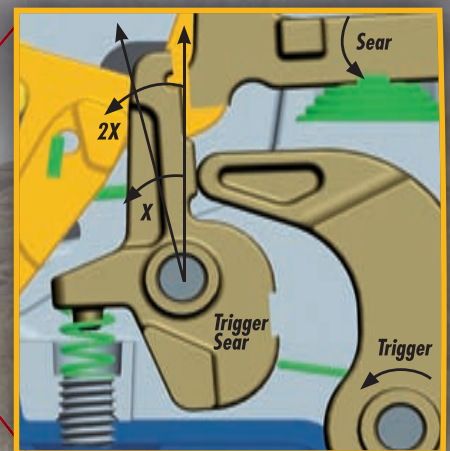

Close-up of unseared (Fired)

For precise shooting there is absolutely no substitute for a crisp, predictable trigger. The X-Bolt's three-lever Feather Trigger™ provides a clean, crisp pull with no take-up or creep and minimal overtravel. The trigger is screw adjustable from 3 to 5 lbs. and factory pre-set at approximately 3½ lbs. An alloy trigger housing contains hard chromed steel components that are highly polished on all critical contact surfaces. Precise engagement angles mean the X-Bolt Feather Trigger feels light and stays that way through many thousands of rounds. Unlike competitors' triggers that rely on a secondary fingerpiece lever, the Feather Trigger is designed right, from the very start.

### RIFLES INDEX

A-BOLT RIFLES	53-59
A-BOLT MAGAZINES	60, 138
AUTOLOADING RIFLES	65-70
BAR RIFLES	65-70
BAR EXTRA MAGAZINES	69, 139
BAR RECOIL PADS	69
BL-22 RIFLES	3, 74
BLR RIFLES	61-64
BLR MAGAZINES	64, 139
BLR SCOUT MOUNT	63, 136
BOSS-CR ACCESSORY	60, 138
BUCK MARK RIFLES	76-77
CUSTOM SHOP	86-88
CENTERFIRE RIFLES	
A-Bolt	53-59
BAR	65-70
BLR	61-64
X-Bolt	3, 45-52

### LEVER-ACTION RIFLES

BL-22	3, 74
BLR	61-64

### MAGAZINES

A-Bolt	60, 138
BAR	69, 139
BLR	64, 139
T-Bolt Double Helix	72, 139
X-Bolt	50, 137

### MOUNTS

63, 136
---------

### RECOIL PADS

69
----

### RIMFIRE RIFLES

BL-22	3, 74
Buck Mark	76-77
SA-22	75
T-Bolt	71-73

### SA-22 RIFLES

75
----

### T-BOLT RIFLES

71-73
-------

### T-BOLT DOUBLE HELIX MAGAZINES

72, 139
---------

### X-BOLT RIFLES

3, 45-52
----------

### X-BOLT EXTRA MAGAZINES

50, 137
---------

### PISTOLS INDEX

1911-22	78-79
1911-22 MAGAZINES	79, 139
BUCK MARK	80-83
BUCK MARK MAGAZINES	80, 139
HI POWER	84-85
HI POWER 75TH ANNIVERSARY	85
HI POWER MAGAZINES	85, 139



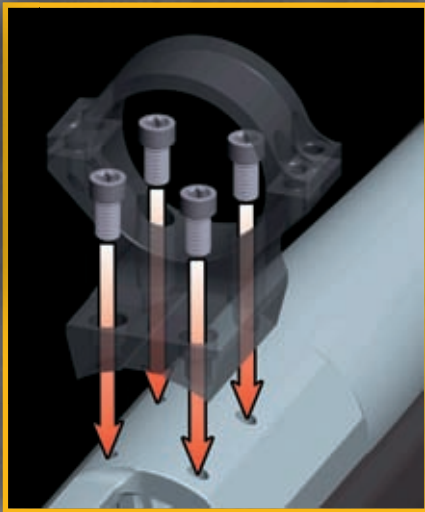

### X-LOCK™ SCOPE MOUNTING SYSTEM

Securely mounted optics are essential for accuracy and precision on any rifle. To ensure the X-Bolt has the most stable scope mounting system possible, X-Lock mounts feature a four screw per base design that replaces the traditional two screw system. With the bases secured at all four corners of the base you get more accurate placement and more secure attachment to the receiver. See page 137 for more details on the new X-Lock Scope Mounting System.

*All Browning firearms are shipped with a free locking device to assist in the safe storage of firearms.*

### INFLEX TECHNOLOGY RECOIL PAD

The Inflex Technology recoil pad is standard on every X-Bolt rifle. This ultra soft pad offers the best recoil absorption available on any rifle. The proprietary construction and material promote a directional deflection of recoil forces, pulling the stock comb away from your face to reduce felt recoil and muzzle climb.



### MAXIMUM GRIP

Composite X-Bolt models combine in-molded textured gripping surfaces and Browning's proven Dura-Touch® Armor Coating for a sure hold and a sleek feel in all climate conditions.



### MAGAZINE

The X-Bolt is fed from a detachable rotary magazine constructed from a durable, lightweight polymer. Cartridges are picked up from the center of the magazine, directly in-line with the bolt, instead of offset as with traditional leaf-spring magazines, for a straight shot right into the chamber. An ergonomic magazine-mounted release lets the magazine rotate directly downward and into your hand. The magazine sits flush with the bottom of the rifle for a sleek appearance. Additional magazines can be kept loaded and carried for easy access.

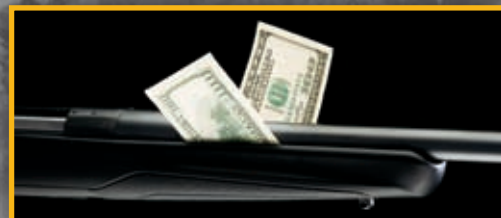

### BARREL

A free-floating barrel is essential for utmost accuracy. The X-Bolt is free-floated by bedding the front and rear of the action for stability. This maintains barrel to stock spacing for consistent accuracy. A recessed muzzle crown helps protect the rifling from damage. Barrels are triple checked for interior finish, straightness and air-gauged for uniformity.



**X-BOLT MICRO MIDAS ▶ SATIN FINISH STOCK**

**NEW**



- RECEIVER** - Steel · Low-luster blued finish · Glass bedded · Drilled and tapped for scope mounts
- BARREL** - Low-luster blued finish · Free-floating · Hand chambered · Target crown
- ACTION** - Bolt-action · 60° bolt lift · Adjustable Feather Trigger™ · Detachable rotary magazine · Top-tang safety · Bolt unlock button
- STOCK** - Satin finish checkered walnut stock · Compact 12½" length of pull for smaller shooters
- FEATURES** - Sling swivel studs installed · Inflex Technology recoil pad (Scope and mounts not included)

(SSA) = Super-Short Action, (SA) = Short Action

	CALIBER	BARREL LENGTH	CODE NUMBER	UPC #	*TOTAL CAPACITY	**AVG. WEIGHT	OVERALL LENGTH	SIGHT RADIUS	***DROP AT COMB	DROP AT HEEL	LENGTH OF PULL	RATE OF TWIST	SUGG. RETAIL
<b>NEW</b>	(SSA) 22-250 Rem.	20"	035249209	023614071174	5	6 lbs. 1 oz.	38½"	—	1½"	½"	12½"	1 in 14"	\$799.99
<b>NEW</b>	(SA) 243 Win.	20"	035248211	023614071181	5	6 lbs. 1 oz.	38½"	—	1½"	½"	12½"	1 in 10"	799.99
<b>NEW</b>	(SA) 7mm-08 Rem.	20"	035248216	023614071198	5	6 lbs. 1 oz.	38½"	—	1½"	½"	12½"	1 in 9½"	799.99
<b>NEW</b>	(SA) 308 Win.	20"	035248218	023614071204	5	6 lbs. 1 oz.	38½"	—	1½"	½"	12½"	1 in 12"	799.99

NOTE: \*Total capacity includes one round in the chamber. \*\*Weights listed are approximate. \*\*\*Measured from centerline of bore.

**X-BOLT WHITE GOLD ▶ GLOSS FINISH STOCK**

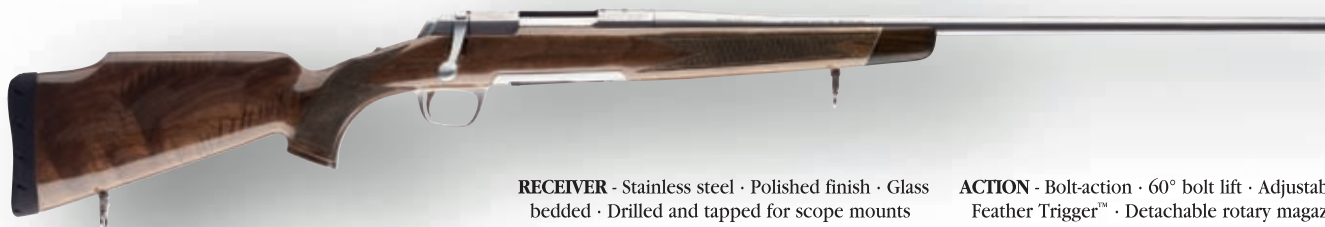

- RECEIVER** - Stainless steel · Polished finish · Glass bedded · Drilled and tapped for scope mounts · Scroll engraving on front and rear receiver
- BARREL** - Stainless steel · Polished stainless finish · Free-floating · Hand chambered · Target crown
- ACTION** - Bolt-action · 60° bolt lift · Adjustable Feather Trigger™ · Detachable rotary magazine · Top-tang safety · Bolt unlock button
- STOCK** - Gloss finish checkered walnut stock · Rosewood fore-end grip and pistol grip cap
- FEATURES** - Sling swivel studs installed · Sling swivels included · Inflex Technology recoil pad

(SSA) = Super-Short Action, (SA) = Short Action, (LA) = Long Action

	CALIBER	BARREL LENGTH	CODE NUMBER	UPC #	*TOTAL CAPACITY	**AVG. WEIGHT	OVERALL LENGTH	SIGHT RADIUS	***DROP AT COMB	DROP AT HEEL	LENGTH OF PULL	RATE OF TWIST	SUGG. RETAIL
<b>NEW</b>	(SSA) 223 Rem.	22"	035251208	023614071334	6	6 lbs. 6 oz.	41¼"	—	¾"	1½"	13¾"	1 in 12"	\$1,339.99
<b>NEW</b>	(SSA) 22-250 Rem.	22"	035251209	023614071341	5	6 lbs. 6 oz.	41¼"	—	¾"	1½"	13¾"	1 in 14"	1,339.99
	(SA) 243 Win.	22"	035235211	023614067276	5	6 lbs. 8 oz.	41¾"	—	¾"	1½"	13¾"	1 in 10"	1,339.99
	(SA) 7mm-08 Rem.	22"	035235216	023614067290	5	6 lbs. 8 oz.	41¾"	—	¾"	1½"	13¾"	1 in 9½"	1,339.99
	(SA) 308 Win.	22"	035235218	023614067283	5	6 lbs. 8 oz.	41¾"	—	¾"	1½"	13¾"	1 in 12"	1,339.99
	(SA) 270 WSM	23"	035235248	023614067306	4	6 lbs. 11 oz.	42¾"	—	¾"	1½"	13¾"	1 in 10"	1,379.99
	(SA) 7mm WSM	23"	035235249	023614067313	4	6 lbs. 11 oz.	42¾"	—	¾"	1½"	13¾"	1 in 9½"	1,379.99
	(SA) 300 WSM	23"	035235246	023614067320	4	6 lbs. 11 oz.	42¾"	—	¾"	1½"	13¾"	1 in 10"	1,379.99
	(SA) 325 WSM	23"	035235277	023614067337	4	6 lbs. 11 oz.	42¾"	—	¾"	1½"	13¾"	1 in 10"	1,379.99
	(LA) 25-06 Rem.	24"	035235223	023614067344	5	6 lbs. 14 oz.	44¾"	—	¾"	1½"	13¾"	1 in 10"	1,339.99
	(LA) 270 Win.	22"	035235224	023614067351	5	6 lbs. 12 oz.	42¾"	—	¾"	1½"	13¾"	1 in 10"	1,339.99
	(LA) 280 Rem.	22"	035235225	023614067368	5	6 lbs. 12 oz.	42¾"	—	¾"	1½"	13¾"	1 in 10"	1,339.99
	(LA) 30-06 Sprg.	22"	035235226	023614067375	5	6 lbs. 12 oz.	42¾"	—	¾"	1½"	13¾"	1 in 10"	1,339.99
	(LA) 7mm Rem. Mag.	26"	035235227	023614067382	4	7 lbs.	46¾"	—	¾"	1½"	13¾"	1 in 9½"	1,379.99
	(LA) 300 Win. Mag.	26"	035235229	023614067399	4	7 lbs.	46¾"	—	¾"	1½"	13¾"	1 in 10"	1,379.99
	(LA) 338 Win. Mag.	26"	035235231	023614067405	4	7 lbs.	46¾"	—	¾"	1½"	13¾"	1 in 10"	1,379.99

NOTE: \*Total capacity includes one round in the chamber. \*\*Weights listed are approximate. \*\*\*Measured from centerline of bore.



**THE STAR OF THE SHOW**

The Browning X-Bolt is proven to be reliable and accurate in far-flung destinations around the globe. Just ask Stephen LeBlanc, host of "Browning Expeditions" and Kristy Lee Cook, host of "Goin' Country." Here, Kristy shows off a monster red stag taken with her X-Bolt in New Zealand.



**X-BOLT MEDALLION ▶ GLOSS FINISH STOCK**



**RECEIVER** - Steel · Engraved with blued finish · Glass bedded · Drilled and tapped for scope mounts  
**BARREL** - Blued finish · Free-floating · Hand chambered · Target crown  
**ACTION** - Bolt-action · 60° bolt lift · Adjustable Feather Trigger™ · Detachable rotary magazine · Top-tang safety · Bolt unlock button

**STOCK** - Gloss finish checkered walnut stock · Rosewood fore-end grip and pistol grip cap  
**FEATURES** - Sling swivel studs installed · Inflex Technology recoil pad

(SSA) = Super-Short Action, (SA) = Short Action, (LA) = Long Action

	CALIBER	BARREL LENGTH	CODE NUMBER	UPC #	*TOTAL CAPACITY	**AVG. WEIGHT	OVERALL LENGTH	SIGHT RADIUS	***DROP AT COMB	DROP AT HEEL	LENGTH OF PULL	RATE OF TWIST	SUGG. RETAIL
<b>X-BOLT MEDALLION (SHOWN)</b>													
	(SSA) 223 Rem.	22"	035204208	023614065791	6	6 lbs. 6 oz.	41¼"	—	11/16"	½"	13¾"	1 in 12"	\$979.99
	(SSA) 22-250 Rem.	22"	035204209	023614065807	5	6 lbs. 6 oz.	41¼"	—	11/16"	½"	13¾"	1 in 14"	979.99
	(SA) 243 Win.	22"	035200211	023614258148	5	6 lbs. 8 oz.	41¾"	—	11/16"	½"	13¾"	1 in 10"	979.99
	(SA) 308 Win.	22"	035200218	023614258155	5	6 lbs. 8 oz.	41¾"	—	11/16"	½"	13¾"	1 in 12"	979.99
	(SA) 270 WSM	23"	035200248	023614258162	4	6 lbs. 11 oz.	42¾"	—	11/16"	½"	13¾"	1 in 10"	1,019.99
	(SA) 7mm WSM	23"	035200249	023614258179	4	6 lbs. 11 oz.	42¾"	—	11/16"	½"	13¾"	1 in 9½"	1,019.99
	(SA) 300 WSM	23"	035200246	023614258186	4	6 lbs. 11 oz.	42¾"	—	11/16"	½"	13¾"	1 in 10"	1,019.99
	(SA) 325 WSM	23"	035200277	023614258193	4	6 lbs. 11 oz.	42¾"	—	11/16"	½"	13¾"	1 in 10"	1,019.99
	(LA) 25-06 Rem.	24"	035200223	023614258209	5	6 lbs. 14 oz.	44¾"	—	11/16"	½"	13¾"	1 in 10"	979.99
	(LA) 270 Win.	22"	035200224	023614258216	5	6 lbs. 12 oz.	42¾"	—	11/16"	½"	13¾"	1 in 10"	979.99
	(LA) 280 Rem.	22"	035200225	023614258223	5	6 lbs. 12 oz.	42¾"	—	11/16"	½"	13¾"	1 in 10"	979.99
	(LA) 30-06 Sprg.	22"	035200226	023614258230	5	6 lbs. 12 oz.	42¾"	—	11/16"	½"	13¾"	1 in 10"	979.99
	(LA) 7mm Rem. Mag.	26"	035200227	023614258247	4	7 lbs.	46¾"	—	11/16"	½"	13¾"	1 in 9½"	1,019.99
	(LA) 300 Win. Mag.	26"	035200229	023614258254	4	7 lbs.	46¾"	—	11/16"	½"	13¾"	1 in 10"	1,019.99
	(LA) 338 Win. Mag.	26"	035200231	023614258261	4	7 lbs.	46¾"	—	11/16"	½"	13¾"	1 in 10"	1,019.99
<b>X-BOLT MEDALLION, LEFT-HAND</b>													
<b>NEW</b>	(SSA) 223 Rem.	22"	035252208	023614071402	6	6 lbs. 6 oz.	41¼"	—	11/16"	½"	13¾"	1 in 12"	\$999.99
<b>NEW</b>	(SSA) 22-250 Rem.	22"	035252209	023614071419	5	6 lbs. 6 oz.	41¼"	—	11/16"	½"	13¾"	1 in 14"	999.99
<b>NEW</b>	(SA) 243 Win.	22"	035253211	023614071426	5	6 lbs. 8 oz.	41¾"	—	11/16"	½"	13¾"	1 in 10"	999.99
<b>NEW</b>	(SA) 308 Win.	22"	035253218	023614071433	5	6 lbs. 8 oz.	41¾"	—	11/16"	½"	13¾"	1 in 12"	999.99
<b>NEW</b>	(SA) 270 WSM	23"	035253248	023614071440	4	6 lbs. 11 oz.	42¾"	—	11/16"	½"	13¾"	1 in 10"	1,039.99
<b>NEW</b>	(SA) 7mm WSM	23"	035253249	023614071457	4	6 lbs. 11 oz.	42¾"	—	11/16"	½"	13¾"	1 in 9½"	1,039.99
<b>NEW</b>	(SA) 300 WSM	23"	035253246	023614071464	4	6 lbs. 11 oz.	42¾"	—	11/16"	½"	13¾"	1 in 10"	1,039.99
<b>NEW</b>	(SA) 325 WSM	23"	035253277	023614071471	4	6 lbs. 11 oz.	42¾"	—	11/16"	½"	13¾"	1 in 10"	1,039.99
<b>NEW</b>	(LA) 25-06 Rem.	24"	035253223	023614071488	5	6 lbs. 14 oz.	44¾"	—	11/16"	½"	13¾"	1 in 10"	999.99
<b>NEW</b>	(LA) 270 Win.	22"	035253224	023614071495	5	6 lbs. 12 oz.	42¾"	—	11/16"	½"	13¾"	1 in 10"	999.99
<b>NEW</b>	(LA) 280 Rem.	22"	035253225	023614071501	5	6 lbs. 12 oz.	42¾"	—	11/16"	½"	13¾"	1 in 10"	999.99
<b>NEW</b>	(LA) 30-06 Sprg.	22"	035253226	023614071518	5	6 lbs. 12 oz.	42¾"	—	11/16"	½"	13¾"	1 in 10"	999.99
<b>NEW</b>	(LA) 7mm Rem. Mag.	26"	035253227	023614071525	4	7 lbs.	46¾"	—	11/16"	½"	13¾"	1 in 9½"	1,039.99
<b>NEW</b>	(LA) 300 Win. Mag.	26"	035253229	023614071532	4	7 lbs.	46¾"	—	11/16"	½"	13¾"	1 in 10"	1,039.99
<b>NEW</b>	(LA) 338 Win. Mag.	26"	035253231	023614071549	4	7 lbs.	46¾"	—	11/16"	½"	13¾"	1 in 10"	1,039.99

NOTE: \*Total capacity includes one round in the chamber. \*\*Weights listed are approximate. \*\*\*Measured from centerline of bore.



X-BOLT HUNTER ▶ SATIN FINISH STOCK



**RECEIVER** - Steel · Low-luster blued finish · Glass bedded · Drilled and tapped for scope mounts  
**BARREL** - Low-luster blued finish · Free-floating · Hand chambered · Target crown  
**ACTION** - Bolt-action · 60° bolt lift · Adjustable Feather Trigger™ · Detachable rotary magazine · Top-tang safety · Bolt unlock button  
**STOCK** - Satin finish checkered walnut stock  
**FEATURES** - Sling swivel studs installed · Inflex Technology recoil pad (Scope and mounts not included)

**THE X-BOLT — TOTAL ACCURACY.**

Every part of the Browning X-Bolt works together to provide a complete package that delivers total accuracy. From the crisp Feather Trigger to the center-feed rotary magazine to the X-Lock system to the comfortable stock design with Inflex recoil pad, everything combines to maximize the accuracy potential of the X-Bolt.

(SSA) = Super-Short Action, (SA) = Short Action, (LA) = Long Action

	CALIBER	BARREL LENGTH	CODE NUMBER	UPC #	*TOTAL CAPACITY	**AVG. WEIGHT	OVERALL LENGTH	SIGHT RADIUS	***DROP AT COMB	DROP AT HEEL	LENGTH OF PULL	RATE OF TWIST	SUGG. RETAIL
<b>X-BOLT HUNTER (SHOWN)</b>													
	(SSA) 223 Rem.	22"	035209208	023614065777	6	6 lbs. 6 oz.	41¼"	—	1½"	½"	13⅝"	1 in 12"	\$839.99
	(SSA) 22-250 Rem.	22"	035209209	023614065784	5	6 lbs. 6 oz.	41¼"	—	1½"	½"	13⅝"	1 in 14"	839.99
	(SA) 243 Win.	22"	035208211	023614257998	5	6 lbs. 8 oz.	41¾"	—	1½"	½"	13⅝"	1 in 10"	839.99
	(SA) 7mm-08 Rem.	22"	035208216	023614258681	5	6 lbs. 8 oz.	41¾"	—	1½"	½"	13⅝"	1 in 9½"	839.99
	(SA) 308 Win.	22"	035208218	023614258001	5	6 lbs. 8 oz.	41¾"	—	1½"	½"	13⅝"	1 in 12"	839.99
	(SA) 270 WSM	23"	035208248	023614258018	4	6 lbs. 11 oz.	42¾"	—	1½"	½"	13⅝"	1 in 10"	879.99
	(SA) 7mm WSM	23"	035208249	023614258025	4	6 lbs. 11 oz.	42¾"	—	1½"	½"	13⅝"	1 in 9½"	879.99
	(SA) 300 WSM	23"	035208246	023614258032	4	6 lbs. 11 oz.	42¾"	—	1½"	½"	13⅝"	1 in 10"	879.99
	(SA) 325 WSM	23"	035208277	023614258049	4	6 lbs. 11 oz.	42¾"	—	1½"	½"	13⅝"	1 in 10"	879.99
	(LA) 25-06 Rem.	24"	035208223	023614258056	5	6 lbs. 14 oz.	44¾"	—	1½"	½"	13⅝"	1 in 10"	839.99
	(LA) 270 Win.	22"	035208224	023614258063	5	6 lbs. 12 oz.	42¾"	—	1½"	½"	13⅝"	1 in 10"	839.99
	(LA) 280 Rem.	22"	035208225	023614258070	5	6 lbs. 12 oz.	42¾"	—	1½"	½"	13⅝"	1 in 10"	839.99
	(LA) 30-06 Sprg.	22"	035208226	023614258087	5	6 lbs. 12 oz.	42¾"	—	1½"	½"	13⅝"	1 in 10"	839.99
	(LA) 7mm Rem. Mag.	26"	035208227	023614258094	4	7 lbs.	46¾"	—	1½"	½"	13⅝"	1 in 9½"	879.99
	(LA) 300 Win. Mag.	26"	035208229	023614258100	4	7 lbs.	46¾"	—	1½"	½"	13⅝"	1 in 10"	879.99
	(LA) 338 Win. Mag.	26"	035208231	023614258117	4	7 lbs.	46¾"	—	1½"	½"	13⅝"	1 in 10"	879.99
<b>X-BOLT HUNTER, LEFT-HAND</b>													
<b>NEW</b>	(SSA) 223 Rem.	22"	035254208	023614071556	6	6 lbs. 6 oz.	41¼"	—	1½"	½"	13⅝"	1 in 12"	\$869.99
<b>NEW</b>	(SSA) 22-250 Rem.	22"	035254209	023614071563	5	6 lbs. 6 oz.	41¼"	—	1½"	½"	13⅝"	1 in 14"	869.99
<b>NEW</b>	(SA) 243 Win.	22"	035255211	023614071570	5	6 lbs. 8 oz.	41¾"	—	1½"	½"	13⅝"	1 in 10"	869.99
<b>NEW</b>	(SA) 7mm-08 Rem.	22"	035255216	023614071594	5	6 lbs. 8 oz.	41¾"	—	1½"	½"	13⅝"	1 in 9½"	869.99
<b>NEW</b>	(SA) 308 Win.	22"	035255218	023614071631	5	6 lbs. 8 oz.	41¾"	—	1½"	½"	13⅝"	1 in 12"	869.99
<b>NEW</b>	(SA) 270 WSM	23"	035255248	023614071600	4	6 lbs. 11 oz.	42¾"	—	1½"	½"	13⅝"	1 in 10"	899.99
<b>NEW</b>	(SA) 7mm WSM	23"	035255249	023614071617	4	6 lbs. 11 oz.	42¾"	—	1½"	½"	13⅝"	1 in 9½"	899.99
<b>NEW</b>	(SA) 300 WSM	23"	035255246	023614071624	4	6 lbs. 11 oz.	42¾"	—	1½"	½"	13⅝"	1 in 10"	899.99
<b>NEW</b>	(SA) 325 WSM	23"	035255277	023614071631	4	6 lbs. 11 oz.	42¾"	—	1½"	½"	13⅝"	1 in 10"	899.99
<b>NEW</b>	(LA) 25-06 Rem.	24"	035255223	023614071648	5	6 lbs. 14 oz.	44¾"	—	1½"	½"	13⅝"	1 in 10"	869.99
<b>NEW</b>	(LA) 270 Win.	22"	035255224	023614071655	5	6 lbs. 12 oz.	42¾"	—	1½"	½"	13⅝"	1 in 10"	869.99
<b>NEW</b>	(LA) 280 Rem.	22"	035255225	023614071662	5	6 lbs. 12 oz.	42¾"	—	1½"	½"	13⅝"	1 in 10"	869.99
<b>NEW</b>	(LA) 30-06 Sprg.	22"	035255226	023614071679	5	6 lbs. 12 oz.	42¾"	—	1½"	½"	13⅝"	1 in 10"	869.99
<b>NEW</b>	(LA) 7mm Rem. Mag.	26"	035255227	023614071686	4	7 lbs.	46¾"	—	1½"	½"	13⅝"	1 in 9½"	899.99
<b>NEW</b>	(LA) 300 Win. Mag.	26"	035255229	023614071693	4	7 lbs.	46¾"	—	1½"	½"	13⅝"	1 in 10"	899.99
<b>NEW</b>	(LA) 338 Win. Mag.	26"	035255231	023614071709	4	7 lbs.	46¾"	—	1½"	½"	13⅝"	1 in 10"	899.99

NOTE: \*Total capacity includes one round in the chamber. \*\*Weights listed are approximate. \*\*\*Measured from centerline of bore.





**X-BOLT MICRO HUNTER** ▶ SATIN FINISH STOCK



**RECEIVER** - Steel · Low-luster blued finish · Glass bedded · Drilled and tapped for scope mounts  
**BARREL** - Low-luster blued finish · Free-floating · Hand chambered · Target crown  
**ACTION** - Bolt-action · 60° bolt lift · Adjustable Feather Trigger™ · Detachable rotary magazine · Top-tang safety · Bolt unlock button

**STOCK** - Satin finish checkered walnut stock · Sized for smaller shooters  
**FEATURES** - Sling swivel studs installed · Inflex Technology recoil pad (Scope and mounts not included)

(SSA) = Super-Short Action, (SA) = Short Action

	CALIBER	BARREL LENGTH	CODE NUMBER	UPC #	*TOTAL CAPACITY	**AVG. WEIGHT	OVERALL LENGTH	SIGHT RADIUS	***DROP AT COMB	DROP AT HEEL	LENGTH OF PULL	RATE OF TWIST	SUGG. RETAIL
<b>X-BOLT MICRO HUNTER (SHOWN)</b>													
	(SSA) 22-250 Rem.	20"	035216209	023614065678	5	5 lbs. 15 oz.	39"	—	1/16"	1/2"	13 3/16"	1 in 14"	\$839.99
	(SA) 243 Win.	20"	035215211	023614065685	5	6 lbs. 2 oz.	39 1/2"	—	1/16"	1/2"	13 3/16"	1 in 10"	839.99
	(SA) 7mm-08 Rem.	20"	035215216	023614065708	5	6 lbs. 2 oz.	39 1/2"	—	1/16"	1/2"	13 3/16"	1 in 9 1/2"	839.99
	(SA) 308 Win.	20"	035215218	023614065692	5	6 lbs. 2 oz.	39 1/2"	—	1/16"	1/2"	13 3/16"	1 in 12"	839.99
	(SA) 270 WSM	22"	035215248	023614065715	4	6 lbs. 7 oz.	41 1/2"	—	1/16"	1/2"	13 3/16"	1 in 10"	879.99
	(SA) 7mm WSM	22"	035215249	023614065722	4	6 lbs. 7 oz.	41 1/2"	—	1/16"	1/2"	13 3/16"	1 in 9 1/2"	879.99
	(SA) 300 WSM	22"	035215246	023614065739	4	6 lbs. 7 oz.	41 1/2"	—	1/16"	1/2"	13 3/16"	1 in 10"	879.99
	(SA) 325 WSM	22"	035215277	023614065746	4	6 lbs. 7 oz.	41 1/2"	—	1/16"	1/2"	13 3/16"	1 in 10"	879.99
<b>X-BOLT MICRO HUNTER, LEFT-HAND</b>													
<b>NEW</b>	(SSA) 22-250 Rem.	20"	035256209	023614071716	5	5 lbs. 15 oz.	39"	—	1/16"	1/2"	13 3/16"	1 in 14"	\$869.99
<b>NEW</b>	(SA) 243 Win.	20"	035257211	023614071723	5	6 lbs. 2 oz.	39 1/2"	—	1/16"	1/2"	13 3/16"	1 in 10"	869.99
<b>NEW</b>	(SA) 7mm-08 Rem.	20"	035257216	023614071747	5	6 lbs. 2 oz.	39 1/2"	—	1/16"	1/2"	13 3/16"	1 in 9 1/2"	869.99
<b>NEW</b>	(SA) 308 Win.	20"	035257218	023614071730	5	6 lbs. 2 oz.	39 1/2"	—	1/16"	1/2"	13 3/16"	1 in 12"	869.99
<b>NEW</b>	(SA) 270 WSM	22"	035257248	023614071754	4	6 lbs. 7 oz.	41 1/2"	—	1/16"	1/2"	13 3/16"	1 in 10"	899.99
<b>NEW</b>	(SA) 7mm WSM	22"	035257249	023614071761	4	6 lbs. 7 oz.	41 1/2"	—	1/16"	1/2"	13 3/16"	1 in 9 1/2"	899.99
<b>NEW</b>	(SA) 300 WSM	22"	035257246	023614071778	4	6 lbs. 7 oz.	41 1/2"	—	1/16"	1/2"	13 3/16"	1 in 10"	899.99
<b>NEW</b>	(SA) 325 WSM	22"	035257277	023614071785	4	6 lbs. 7 oz.	41 1/2"	—	1/16"	1/2"	13 3/16"	1 in 10"	899.99

NOTE: \*Total capacity includes one round in the chamber. \*\*Weights listed are approximate. \*\*\*Measured from centerline of bore.

**X-BOLT EXTRA MAGAZINES**

CALIBER	CODE NUMBER	UPC #	SUGG. RETAIL
Long Action Magnum: 338 Win. Mag., 300 Win. Mag., 7mm Rem. Mag.	112044601	023614048183	\$49.99
Long Action Standard: 30-06 Sprg., 280 Rem., 270 Win., 25-06 Rem.	112044602	023614048213	49.99
Short Action Magnum: 325 WSM, 300 WSM, 7mm WSM, 270 WSM	112044603	023614048244	49.99
Short Action Standard: 308 Win., 7mm-08 Rem., 243 Win.	112044604	023614048275	49.99
Super-Short Action Standard: 22-250 Rem.	112044009	023614059103	49.99
Super-Short Action Standard: 223 Rem.	112044008	023614059080	49.99
Large Magnum Calibers: 375 H&H Mag.	112044606	023614048305	49.99



**X-BOLT COMPOSITE STALKER** ▶ DURA-TOUCH® ARMOR COATING ON STOCK



**RECEIVER** - Steel · Matte blued finish  
 · Glass bedded · Drilled and tapped for scope mounts  
**BARREL** - Matte blued finish · Free-floating  
 · Hand chambered · Target crown  
**ACTION** - Bolt-action · 60° bolt lift · Adjustable Feather Trigger™ · Detachable rotary magazine  
 · Top-tang safety · Bolt unlock button

**STOCK** - Composite · Textured gripping surfaces · Palm swell  
 · Matte black · Dura-Touch® Armor Coating  
**FEATURES** - Sling swivel studs installed · Inflex Technology recoil pad  
 (Scope and mounts not included)

**X-BOLT STAINLESS STALKER** ▶ DURA-TOUCH® ARMOR COATING ON STOCK



**RECEIVER** - Stainless steel · Matte finish · Glass bedded · Drilled and tapped for scope mounts  
**BARREL** - Stainless steel · Matte finish · Free-floating  
 · Hand chambered · Target crown  
**ACTION** - Bolt-action · 60° bolt lift · Adjustable Feather Trigger™ · Detachable rotary magazine  
 · Top-tang safety · Bolt unlock button

**STOCK** - Composite · Textured gripping surfaces · Palm swell  
 · Matte black · Dura-Touch® Armor Coating  
**FEATURES** - Sling swivel studs installed · Inflex Technology recoil pad  
 (Scope and mounts not included)

(SSA) = Super-Short Action, (SA) = Short Action, (LA) = Long Action

CALIBER	BARREL LENGTH	CODE NUMBER	UPC #	*TOTAL CAPACITY	**AVG. WEIGHT	OVERALL LENGTH	SIGHT RADIUS	***DROP AT COMB	DROP AT HEEL	LENGTH OF PULL	RATE OF TWIST	SUGG. RETAIL
<b>X-BOLT COMPOSITE STALKER</b>												
(SSA) 223 Rem.	22"	035205208	023614065753	6	6 lbs. 3 oz.	41¼"	—	1½"	½"	13¾"	1 in 12"	\$799.99
(SSA) 22-250 Rem.	22"	035205209	023614065760	5	6 lbs. 3 oz.	41¼"	—	1½"	½"	13¾"	1 in 14"	799.99
(SA) 243 Win.	22"	035201211	023614258308	5	6 lbs. 5 oz.	41¾"	—	1½"	½"	13¾"	1 in 10"	799.99
(SA) 7mm-08 Rem.	22"	035201216	023614258322	5	6 lbs. 5 oz.	41¾"	—	1½"	½"	13¾"	1 in 9½"	799.99
(SA) 308 Win.	22"	035201218	023614258315	5	6 lbs. 5 oz.	41¾"	—	1½"	½"	13¾"	1 in 12"	799.99
(SA) 270 WSM	23"	035201248	023614258339	4	6 lbs. 8 oz.	42¾"	—	1½"	½"	13¾"	1 in 10"	839.99
(SA) 7mm WSM	23"	035201249	023614258346	4	6 lbs. 8 oz.	42¾"	—	1½"	½"	13¾"	1 in 9½"	839.99
(SA) 300 WSM	23"	035201246	023614258353	4	6 lbs. 8 oz.	42¾"	—	1½"	½"	13¾"	1 in 10"	839.99
(SA) 325 WSM	23"	035201277	023614258360	4	6 lbs. 8 oz.	42¾"	—	1½"	½"	13¾"	1 in 10"	839.99
(LA) 25-06 Rem.	24"	035201223	023614258377	5	6 lbs. 11 oz.	44¾"	—	1½"	½"	13¾"	1 in 10"	799.99
(LA) 270 Win.	22"	035201224	023614258384	5	6 lbs. 9 oz.	42¾"	—	1½"	½"	13¾"	1 in 10"	799.99
(LA) 280 Rem.	22"	035201225	023614258391	5	6 lbs. 9 oz.	42¾"	—	1½"	½"	13¾"	1 in 10"	799.99
(LA) 30-06 Sprg.	22"	035201226	023614258407	5	6 lbs. 9 oz.	42¾"	—	1½"	½"	13¾"	1 in 10"	799.99
(LA) 7mm Rem. Mag.	26"	035201227	023614258414	4	6 lbs. 13 oz.	46¾"	—	1½"	½"	13¾"	1 in 9½"	839.99
(LA) 300 Win. Mag.	26"	035201229	023614258421	4	6 lbs. 13 oz.	46¾"	—	1½"	½"	13¾"	1 in 10"	839.99
(LA) 338 Win. Mag.	26"	035201231	023614258438	4	6 lbs. 13 oz.	46¾"	—	1½"	½"	13¾"	1 in 10"	839.99
<b>X-BOLT STAINLESS STALKER</b>												
(SSA) 223 Rem.	22"	035206208	023614065814	6	6 lbs. 3 oz.	41¼"	—	1½"	½"	13¾"	1 in 12"	\$1,069.99
(SSA) 22-250 Rem.	22"	035206209	023614065821	5	6 lbs. 3 oz.	41¼"	—	1½"	½"	13¾"	1 in 14"	1,069.99
(SA) 243 Win.	22"	035202211	023614258452	5	6 lbs. 5 oz.	41¾"	—	1½"	½"	13¾"	1 in 10"	1,069.99
(SA) 7mm-08 Rem.	22"	035202216	023614258476	5	6 lbs. 5 oz.	41¾"	—	1½"	½"	13¾"	1 in 9½"	1,069.99
(SA) 308 Win.	22"	035202218	023614258469	5	6 lbs. 5 oz.	41¾"	—	1½"	½"	13¾"	1 in 12"	1,069.99
(SA) 270 WSM	23"	035202248	023614258483	4	6 lbs. 8 oz.	42¾"	—	1½"	½"	13¾"	1 in 10"	1,099.99
(SA) 7mm WSM	23"	035202249	023614258490	4	6 lbs. 8 oz.	42¾"	—	1½"	½"	13¾"	1 in 9½"	1,099.99
(SA) 300 WSM	23"	035202246	023614258506	4	6 lbs. 8 oz.	42¾"	—	1½"	½"	13¾"	1 in 10"	1,099.99
(SA) 325 WSM	23"	035202277	023614258513	4	6 lbs. 8 oz.	42¾"	—	1½"	½"	13¾"	1 in 10"	1,099.99
(LA) 25-06 Rem.	24"	035202223	023614258520	5	6 lbs. 11 oz.	44¾"	—	1½"	½"	13¾"	1 in 10"	1,069.99
(LA) 270 Win.	22"	035202224	023614258537	5	6 lbs. 9 oz.	42¾"	—	1½"	½"	13¾"	1 in 10"	1,069.99
(LA) 280 Rem.	22"	035202225	023614258544	5	6 lbs. 9 oz.	42¾"	—	1½"	½"	13¾"	1 in 10"	1,069.99
(LA) 30-06 Sprg.	22"	035202226	023614258551	5	6 lbs. 9 oz.	42¾"	—	1½"	½"	13¾"	1 in 10"	1,069.99
(LA) 7mm Rem. Mag.	26"	035202227	023614258568	4	6 lbs. 13 oz.	46¾"	—	1½"	½"	13¾"	1 in 9½"	1,099.99
(LA) 300 Win. Mag.	26"	035202229	023614258575	4	6 lbs. 13 oz.	46¾"	—	1½"	½"	13¾"	1 in 10"	1,099.99
(LA) 338 Win. Mag.	26"	035202231	023614258582	4	6 lbs. 13 oz.	46¾"	—	1½"	½"	13¾"	1 in 10"	1,099.99
<b>NEW</b> (LA) 375 H&H Mag. (open sights)	24"	035202132	023614258599	4	6 lbs. 13 oz.	46¾"	20"	1½"	½"	13¾"	1 in 12"	1,139.99

NOTE: \*Total capacity includes one round in the chamber. \*\*Weights listed are approximate. \*\*\*Measured from centerline of bore.



**X-BOLT VARMINT STALKER ▶ DURA-TOUCH® ARMOR COATING ON STOCK**



**RECEIVER** - Steel · Matte blued finish  
· Glass bedded · Drilled and tapped for scope mounts  
**BARREL** - Medium heavy · Matte blued finish · Free-floating  
· Hand chambered · Target crown

**ACTION** - Bolt-action · 60° bolt lift · Adjustable Feather Trigger™ · Detachable rotary magazine · Top-tang safety · Bolt unlock button  
**STOCK** - Composite · Textured gripping surfaces · Palm swell · Matte black · Dura-Touch® Armor Coating  
**FEATURES** - Sling swivel studs installed · Inflex Technology recoil pad

**X-BOLT RMEF® WHITE GOLD ▶ GLOSS FINISH STOCK**



RMEF Logo Grip Cap

**RECEIVER** - Stainless steel · Gold engraved with low luster finish · Glass bedded · Drilled and tapped for scope mounts  
**BARREL** - Stainless steel · Low luster finish · Free-floating · Hand chambered · Target crown

**ACTION** - Bolt-action · 60° bolt lift · Adjustable Feather Trigger™ · Detachable rotary magazine · Top-tang safety · Bolt unlock button  
**STOCK** - Select gloss finish walnut · Raised cheekpiece · Checkered · Rosewood grip and forearm caps · RMEF logo inset grip cap  
**FEATURES** - Sling swivel studs installed · Inflex Technology recoil pad · Sling swivels included

**X-BOLT RMEF® SPECIAL HUNTER ▶ SATIN FINISH STOCK**

**RECEIVER** - Steel · Low-luster blued finish · Glass bedded · Drilled and tapped for scope mounts  
**BARREL** - Matte blued finish · Free-floating · Hand chambered · Target crown

**ACTION** - Bolt-action · 60° bolt lift · Adjustable Feather Trigger™ · Detachable rotary magazine · Top-tang safety · Bolt unlock button  
**STOCK** - Satin finish walnut · Raised cheekpiece · Checkered · Rosewood grip cap · RMEF logo inset grip cap  
**FEATURES** - Sling swivel studs installed · Inflex Technology recoil pad



(SSA) = Super-Short Action, (SA) = Short Action

CALIBER	BARREL LENGTH	CODE NUMBER	UPC #	*TOTAL CAPACITY	**AVG. WEIGHT	OVERALL LENGTH	SIGHT RADIUS	***DROP AT COMB	DROP AT HEEL	LENGTH OF PULL	RATE OF TWIST	SUGG. RETAIL
<b>X-BOLT VARMINT STALKER</b>												
(SSA) 223 Rem.	24"	035207208	023614065623	6	7 lbs. 15 oz.	43¼"	—	11/16"	½"	13¾"	1 in 12"	\$1,069.99
(SSA) 22-250 Rem.	26"	035207209	023614065630	5	8 lbs. 2 oz.	45¼"	—	11/16"	½"	13¾"	1 in 14"	1,069.99
(SA) 243 Win.	24"	035203211	023614065647	5	8 lbs. 1 oz.	43¾"	—	11/16"	½"	13¾"	1 in 10"	1,069.99
(SA) 308 Win.	24"	035203218	023614065654	5	8 lbs. 1 oz.	43¾"	—	11/16"	½"	13¾"	1 in 12"	1,069.99
<b>X-BOLT RMEF WHITE GOLD</b>												
(SA) 325 WSM	23"	035217277	023614065869	4	7 lbs. 3 oz.	42¾"	—	¾"	17/16"	13¾"	1 in 10"	\$1,439.99
<b>X-BOLT RMEF SPECIAL HUNTER</b>												
(SA) 325 WSM	23"	035218277	023614065876	4	6 lbs. 14 oz.	42¾"	—	¾"	17/16"	13¾"	1 in 10"	\$939.99

NOTE: \*Total capacity includes one round in the chamber. \*\*Weights listed are approximate. \*\*\*Measured from centerline of bore.



# A-BOLT

## A REPUTATION OF DEPENDABILITY.

Outstanding accuracy and reliable performance are within your reach with a versatile Browning A-Bolt rifle. These proven rifles include groundbreaking features like an easy-to-reach tang safety and 60° bolt lift, both of which allow for faster, more convenient shooting. The A-Bolt is also available with the BOSS® System that dials-in barrel harmonics to precisely match the ammunition used for unequalled accuracy on the range or from your stand.



## THE BOSS® SYSTEM

The Ballistic Optimizing Shooting System is designed to squeeze maximum accuracy from the A-Bolt. The tunable BOSS System easily dials-in barrel harmonics to precisely match the specific ammunition being fired, resulting in amazingly tight groups. The BOSS System is available as an option on the Medallion, Composite Stalker, Stainless Stalker, M-1000 Eclipse and Stainless M-1000 Eclipse. An interchangeable, non-ported BOSS-CR is also included.

## BOSS-CR

This accessory is also included with all BOSS-equipped A-Bolt rifles and offers all the accuracy advantages of the original BOSS without the muzzle brake feature.

*All Browning firearms are shipped with a free locking device to assist in the safe storage of firearms.*



### BOLT-ACTION

With a fast 60° lift that doesn't have you banging your hand on the scope, the bolt incorporates a non-rotating sleeve that runs the full length of the bolt. When unlocked, three guide ribs on the bolt sleeve align with the three locking lugs to allow the bolt to slide smoothly. When locked, the three lugs provide massive bolt strength. The A-Bolt feeds smoothly because of its unique, patented cartridge depressor. This cartridge depressor stays in position, independent of the bolt rotation, as the bolt slides gently over the cartridges in the magazine. The bolt face is recessed, completely surrounding the cartridge base.



### MAGAZINE

Hinged floorplate with detachable box magazine makes it simple and fast to load a spare magazine.

### MAGAZINE CAPACITY

Three in magazine, one in chamber. Standard calibers: Four in magazine, one in chamber. 223 Rem.: Five in magazine, one in chamber.



### BEDDED ACTION AND FREE-FLOATED BARREL

The barrel is free-floating and the action is glass bedded at the recoil lug and at the front of the receiver to maintain the proper spacing around the barrel for consistent accuracy. Every A-Bolt features a recessed muzzle crown to protect the rifling. Barrels are hand chambered and triple checked for interior finish, straightness and air-gauged for uniformity.



*Script*



*Block*

### PERSONALIZED ENGRAVING

The bolt of the A-Bolt rifle can be personalized with your name. Call (800) 333-3288. Not available on the Mountain Ti model.





**A-BOLT MOUNTAIN Ti, MOSSY OAK® BREAK-UP® INFINITY™ ▶ DURA-TOUCH® ARMOR COATING ON STOCK**



**DURA-TOUCH®**  
Armor Coating



- RECEIVER** - Titanium · Matte finish · Glass bedded · Drilled and tapped for scope mounts
- BARREL** - Stainless steel · Matte finish · Free-floating · Hand chambered · Target crown
- ACTION** - Bolt-action · 60° bolt lift · Stainless steel bolt face with composite bolt sleeve · Adjustable trigger · Detachable box magazine · Hinged floorplate · Top-tang safety
- STOCK** - Bell and Carlson™ synthetic (magnum calibers include aluminium bedding block for added strength) · Dura-Touch® Armor Coating · Mossy Oak® Break-Up® Infinity™
- FEATURES** - Sling swivel studs installed · Pachmayr® Decelerator® recoil pad

**A-BOLT HUNTER, FULL LINE DEALER ▶ SATIN FINISH STOCK**

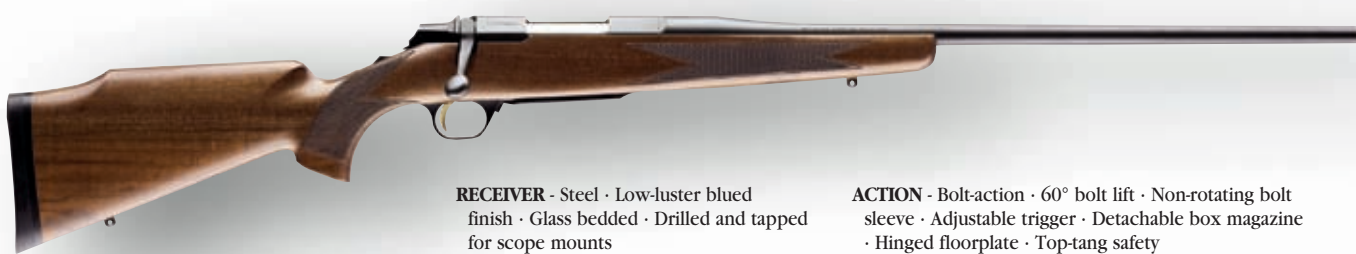

- RECEIVER** - Steel · Low-luster blued finish · Glass bedded · Drilled and tapped for scope mounts
- BARREL** - Low-luster blued finish · Free-floating · Hand chambered · Target crown

- ACTION** - Bolt-action · 60° bolt lift · Non-rotating bolt sleeve · Adjustable trigger · Detachable box magazine · Hinged floorplate · Top-tang safety
- STOCK** - Satin finish walnut · Raised cheekpiece · Checkered
- FEATURES** - Sling swivel studs installed · Recoil pad · Available only from Browning Full Line and Medallion Dealers

(SA) = Short Action

	CALIBER	BARREL LENGTH	CODE NUMBER	UPC #	*TOTAL CAPACITY	**AVG. WEIGHT	OVERALL LENGTH	SIGHT RADIUS	***DROP AT COMB	DROP AT HEEL	LENGTH OF PULL	RATE OF TWIST	SUGG. RETAIL
<b>A-BOLT MOUNTAIN Ti, MOSSY OAK BREAK-UP INFINITY</b>													
	(SA) 243 Win.	22"	035195211	023614068600	5	5 lbs. 8 oz.	41¾"	—	⅝"	½"	13¾"	1 in 10"	\$1,959.99
	(SA) 7mm-08 Rem.	22"	035195216	023614068624	5	5 lbs. 7 oz.	41¾"	—	⅝"	½"	13¾"	1 in 9½"	1,959.99
	(SA) 308 Win.	22"	035195218	023614068617	5	5 lbs. 6 oz.	41¾"	—	⅝"	½"	13¾"	1 in 12"	1,959.99
	(SA) 270 WSM	23"	035195248	023614068631	4	5 lbs. 12 oz.	42¾"	—	⅝"	½"	13¾"	1 in 10"	1,999.99
	(SA) 7mm WSM	23"	035195249	023614068648	4	5 lbs. 12 oz.	42¾"	—	⅝"	½"	13¾"	1 in 9½"	1,999.99
	(SA) 300 WSM	23"	035195246	023614068655	4	5 lbs. 12 oz.	42¾"	—	⅝"	½"	13¾"	1 in 10"	1,999.99
	(SA) 325 WSM	23"	035195277	023614068662	4	5 lbs. 12 oz.	42¾"	—	⅝"	½"	13¾"	1 in 10"	1,999.99
<b>A-BOLT HUNTER, FULL LINE DEALER</b>													
	(SA) 270 WSM	23"	035017248	023614239024	4	6 lbs. 9 oz.	42¾"	—	⅞"	1⅝"	13⅝"	1 in 10"	\$979.99
	(SA) 7mm WSM	23"	035017249	023614239031	4	6 lbs. 9 oz.	42¾"	—	⅞"	1⅝"	13⅝"	1 in 9½"	979.99
	(SA) 300 WSM	23"	035017246	023614239048	4	6 lbs. 9 oz.	42¾"	—	⅞"	1⅝"	13⅝"	1 in 10"	979.99
	(SA) 325 WSM	23"	035017277	023614249887	4	6 lbs. 9 oz.	42¾"	—	⅞"	1⅝"	13⅝"	1 in 10"	979.99

NOTE: \*Total capacity includes one round in the chamber. \*\*Weights listed are approximate. \*\*\*Measured from centerline of bore.



**A-BOLT MICRO HUNTER ▶ SATIN FINISH STOCK**



**RECEIVER** - Steel · Low-luster blued finish · Glass bedded · Drilled and tapped for scope mounts  
**BARREL** - Low-luster blued finish · Free-floating · Hand chambered · Target crown

**ACTION** - Bolt-action · 60° bolt lift · Non-rotating bolt sleeve · Adjustable trigger · Detachable box magazine · Hinged floorplate · Top-tang safety  
**STOCK** - Satin finish walnut · Sized for smaller shooters · Checkered  
**FEATURES** - Sling swivel studs installed · Recoil pad

**A-BOLT MEDALLION ▶ GLOSS FINISH STOCK**



BOSS® System

**RECEIVER** - Steel · Engraved with blued finish · Glass bedded · Drilled and tapped for scope mounts  
**BARREL** - Blued finish · Free-floating · Hand chambered · Target crown  
**ACTION** - Bolt-action · 60° bolt lift · Non-rotating bolt sleeve · Adjustable trigger · Detachable box magazine · Hinged floorplate · Top-tang safety  
**STOCK** - Select gloss finish walnut · Rosewood fore-end and grip caps · Checkered  
**FEATURES** - Sling swivels included · Recoil pad · BOSS® System optional



(SA) = Short Action, (LA) = Long Action

CALIBER	BARREL LENGTH	CODE NUMBER	UPC #	*TOTAL CAPACITY	**AVG. WEIGHT	OVERALL LENGTH	SIGHT RADIUS	***DROP AT COMB	DROP AT HEEL	LENGTH OF PULL	RATE OF TWIST	SUGG. RETAIL
<b>A-BOLT MICRO HUNTER</b>												
(SA) 22 Hornet	22"	035020206	023614232933	4	6 lbs. 6 oz.	41½"	—	5/8"	½"	13⅜"	1 in 16"	\$829.99
<b>A-BOLT MICRO HUNTER, LEFT-HAND (SHOWN)</b>												
(SA) 22 Hornet	22"	035026206	023614240877	4	6 lbs. 6 oz.	41½"	—	5/8"	½"	13⅜"	1 in 16"	\$869.99
<b>A-BOLT MEDALLION</b>												
(LA) 375 H&H Mag. (open sights)	26"	035002132	023614633310	4	7 lbs. 1 oz.	46½"	20"	5/8"	½"	13⅜"	1 in 12"	\$989.99
<b>A-BOLT MEDALLION WITH BOSS (SHOWN)</b>												
(SA) 270 WSM	23"	035002348	023614241393	4	6 lbs. 9 oz.	42¾"	—	5/8"	½"	13⅜"	1 in 10"	\$1,099.99
(SA) 7mm WSM	23"	035002349	023614241409	4	6 lbs. 9 oz.	42¾"	—	5/8"	½"	13⅜"	1 in 9½"	1,099.99
(SA) 300 WSM	23"	035002346	023614238324	4	6 lbs. 9 oz.	42¾"	—	5/8"	½"	13⅜"	1 in 10"	1,099.99
(SA) 325 WSM	23"	035002377	023614252405	4	6 lbs. 9 oz.	42¾"	—	5/8"	½"	13⅜"	1 in 10"	1,099.99
(LA) 270 Win.	22"	035002324	023614630692	5	6 lbs. 11 oz.	42½"	—	5/8"	½"	13⅜"	1 in 10"	1,069.99
(LA) 30-06 Sprg.	22"	035002326	023614630708	5	6 lbs. 11 oz.	42½"	—	5/8"	½"	13⅜"	1 in 10"	1,069.99
(LA) 7mm Rem. Mag.	26"	035002327	023614630715	4	7 lbs. 1 oz.	46½"	—	5/8"	½"	13⅜"	1 in 9½"	1,099.99
(LA) 300 Win. Mag.	26"	035002329	023614632344	4	7 lbs. 1 oz.	46½"	—	5/8"	½"	13⅜"	1 in 10"	1,099.99
(LA) 338 Win. Mag.	26"	035002331	023614632351	4	7 lbs. 1 oz.	46½"	—	5/8"	½"	13⅜"	1 in 10"	1,099.99
(LA) 375 H&H Mag. (open sights)	24"	035002332	023614643890	4	7 lbs.	44½"	13"	5/8"	½"	13⅜"	1 in 12"	1,099.99

NOTE: \*Total capacity includes one round in the chamber. \*\*Weights listed are approximate. \*\*\*Measured from centerline of bore.



**A-BOLT STAINLESS STALKER WITH BOSS® ▶ NON-GLARE COMPOSITE FINISH STOCK**



**RECEIVER** - Stainless steel · Matte finish  
· Glass bedded · Drilled and tapped for scope mounts  
**BARREL** - Stainless steel · Matte finish  
· Free-floating · Hand chambered  
· Target crown

**ACTION** - Bolt-action · 60° bolt lift  
· Non-rotating bolt sleeve · Adjustable stainless steel trigger · Detachable box magazine  
· Hinged floorplate · Top-tang safety  
**STOCK** - Composite · Palm swell  
· Matte black · Checkered  
**FEATURES** - Sling swivel studs installed  
· Recoil pad · BOSS® System



**A-BOLT COMPOSITE STALKER WITH BOSS® ▶ NON-GLARE COMPOSITE FINISH STOCK**



**RECEIVER** - Steel · Matte blued finish · Glass bedded  
· Drilled and tapped for scope mounts  
**BARREL** - Matte blued finish · Free-floating  
· Hand chambered · Target crown

**ACTION** - Bolt-action · 60° bolt lift · Non-rotating bolt sleeve · Adjustable trigger · Detachable box magazine · Hinged floorplate · Top-tang safety  
**STOCK** - Composite · Palm swell · Matte black · Checkered  
**FEATURES** - Sling swivel studs installed  
· Recoil pad · BOSS® System

(SA) = Short Action, (LA) = Long Action

CALIBER	BARREL LENGTH	CODE NUMBER	UPC #	*TOTAL CAPACITY	**AVG. WEIGHT	OVERALL LENGTH	SIGHT RADIUS	***DROP AT COMB	DROP AT HEEL	LENGTH OF PULL	RATE OF TWIST	SUGG. RETAIL
<b>A-BOLT STAINLESS STALKER WITH BOSS (SHOWN)</b>												
(SA) 270 WSM	23"	035008348	023614241416	4	6 lbs. 6 oz.	42¾"	—	⅝"	½"	13¾"	1 in 10"	\$1,199.99
(SA) 7mm WSM	23"	035008349	023614241423	4	6 lbs. 6 oz.	42¾"	—	⅝"	½"	13¾"	1 in 9½"	1,199.99
(SA) 300 WSM	23"	035008346	023614238300	4	6 lbs. 6 oz.	42¾"	—	⅝"	½"	13¾"	1 in 10"	1,199.99
(SA) 325 WSM	23"	035008377	023614252399	4	6 lbs. 6 oz.	42¾"	—	⅝"	½"	13¾"	1 in 10"	1,199.99
(LA) 270 Win.	22"	035008324	023614632610	5	6 lbs. 11 oz.	42½"	—	⅝"	½"	13¾"	1 in 10"	1,179.99
(LA) 30-06 Sprg.	22"	035008326	023614632634	5	6 lbs. 11 oz.	42½"	—	⅝"	½"	13¾"	1 in 10"	1,179.99
(LA) 7mm Rem. Mag.	26"	035008327	023614632641	4	7 lbs. 3 oz.	46½"	—	⅝"	½"	13¾"	1 in 9½"	1,199.99
(LA) 300 Win. Mag.	26"	035008329	023614632658	4	7 lbs. 3 oz.	46½"	—	⅝"	½"	13¾"	1 in 10"	1,199.99
(LA) 338 Win. Mag.	26"	035008331	023614632665	4	7 lbs. 3 oz.	46½"	—	⅝"	½"	13¾"	1 in 10"	1,199.99
(LA) 375 H&H Mag. (open sights)	24"	035008332	023614643913	4	7 lbs.	44½"	13"	⅝"	½"	13¾"	1 in 12"	1,199.99
<b>A-BOLT STAINLESS STALKER WITH BOSS, LEFT-HAND</b>												
(LA) 270 Win.	22"	035009324	023614632689	5	6 lbs. 11 oz.	42¾"	—	⅝"	½"	13¾"	1 in 10"	\$1,199.99
(LA) 30-06 Sprg.	22"	035009326	023614632702	5	6 lbs. 11 oz.	42¾"	—	⅝"	½"	13¾"	1 in 10"	1,199.99
(LA) 7mm Rem. Mag.	26"	035009327	023614632719	4	7 lbs. 3 oz.	46¾"	—	⅝"	½"	13¾"	1 in 9½"	1,239.99
(LA) 300 Win. Mag.	26"	035009329	023614632726	4	7 lbs. 3 oz.	46¾"	—	⅝"	½"	13¾"	1 in 10"	1,239.99
(LA) 338 Win. Mag.	26"	035009331	023614632733	4	7 lbs. 3 oz.	46¾"	—	⅝"	½"	13¾"	1 in 10"	1,239.99
(LA) 375 H&H Mag. (open sights)	24"	035009332	023614643920	4	7 lbs.	44¾"	13"	⅝"	½"	13¾"	1 in 12"	1,239.99
<b>A-BOLT COMPOSITE STALKER WITH BOSS (SHOWN)</b>												
(SA) 270 WSM	23"	035012348	023614241324	4	6 lbs. 6 oz.	42¾"	—	⅝"	½"	13¾"	1 in 10"	\$979.99
(SA) 7mm WSM	23"	035012349	023614241386	4	6 lbs. 6 oz.	42¾"	—	⅝"	½"	13¾"	1 in 9½"	979.99
(SA) 300 WSM	23"	035012346	023614238317	4	6 lbs. 6 oz.	42¾"	—	⅝"	½"	13¾"	1 in 10"	979.99
(SA) 325 WSM	23"	035012377	023614252382	4	6 lbs. 6 oz.	42¾"	—	⅝"	½"	13¾"	1 in 10"	979.99
(LA) 25-06 Rem.	24"	035012323	023614632535	5	6 lbs. 14 oz.	44½"	—	⅝"	½"	13¾"	1 in 10"	949.99
(LA) 270 Win.	22"	035012324	023614632542	5	6 lbs. 11 oz.	42½"	—	⅝"	½"	13¾"	1 in 10"	949.99
(LA) 30-06 Sprg.	22"	035012326	023614632566	5	6 lbs. 11 oz.	42½"	—	⅝"	½"	13¾"	1 in 10"	949.99
(LA) 7mm Rem. Mag.	26"	035012327	023614632573	4	7 lbs. 3 oz.	46½"	—	⅝"	½"	13¾"	1 in 9½"	979.99
(LA) 300 Win. Mag.	26"	035012329	023614632580	4	7 lbs. 3 oz.	46½"	—	⅝"	½"	13¾"	1 in 10"	979.99
(LA) 338 Win. Mag.	26"	035012331	023614632597	4	7 lbs. 3 oz.	46½"	—	⅝"	½"	13¾"	1 in 10"	979.99

NOTE: \*Total capacity includes one round in the chamber. \*\*Weights listed are approximate. \*\*\*Measured from centerline of bore.



**A-BOLT TARGET** ▶ SATIN FINISH LAMINATED STOCK



**RECEIVER** - Steel · Matte blued finish · Glass bedded  
 · Drilled and tapped for scope mounts  
**BARREL** - Heavy bull contour · Matte blued finish  
 · Free-floating · Hand chambered · Target crown  
**ACTION** - Bolt-action · 60° bolt lift · Non-rotating bolt sleeve  
 · Single-set trigger · Hinged floorplate · Top-tang safety

**STOCK** - Satin finish gray laminate wood · Target style with wide, flat fore-end · Adjustable comb · Right-hand palm swell · Checkered  
**FEATURES** - Front sling swivel installed · Recoil pad  
 (Scope and mounts not included)

**A-BOLT TARGET STAINLESS** ▶ SATIN FINISH LAMINATED STOCK



**RECEIVER** - Stainless steel · Low luster finish  
 · Glass bedded · Drilled and tapped for scope mounts  
**BARREL** - Heavy bull contour · Stainless steel · Low luster finish  
 · Free-floating · Hand chambered · Target crown  
**ACTION** - Bolt-action · 60° bolt lift · Non-rotating bolt sleeve  
 · Single-set trigger · Hinged floorplate · Top-tang safety

**STOCK** - Satin finish gray laminate wood · Target style with wide, flat fore-end · Adjustable comb · Right-hand palm swell · Checkered  
**FEATURES** - Front sling swivel installed · Recoil pad  
 (Scope and mounts not included)

**A-BOLT TARGET RIFLES. TACK-DRIVING ACCURACY STRAIGHT FROM THE BOX.**

Producing nothing short of jaw-dropping performance, Browning A-Bolt Target rifles feature a precise target-style, single-set trigger that is factory-adjusted to approximately 9-14 ounces (250-400 grams) of pull weight in the set mode, and also operates as a conventional trigger with an adjustment range of 4-6 lbs. Fitted with a 28" target barrel, the action is carefully bedded into a beautiful laminated stock with a wide fore-end for exceptional stability on sandbags or from a bench rest. A fully adjustable comb allows you to dial-in perfect eye-to-scope alignment, even with large objective target optics. Lastly, a close-radius pistol grip ensures an easy reach to the trigger, so you squeeze the most out of an A-Bolt Target rifle's accuracy.

(SA) = Short Action

CALIBER	BARREL LENGTH	CODE NUMBER	UPC #	*TOTAL CAPACITY	**AVG. WEIGHT	OVERALL LENGTH	SIGHT RADIUS	***DROP AT COMB	DROP AT HEEL	LENGTH OF PULL	RATE OF TWIST	SUGG. RETAIL
<b>A-BOLT TARGET</b>												
(SA) 223 Rem.	28"	035189208	023614064879	6	13 lbs. 4 oz.	47¾"	—	⅝" Adj.	⅝" Adj.	13¾"	1 in 8"	\$1,379.99
(SA) 308 Win.	28"	035189218	023614064886	5	13 lbs.	47¾"	—	⅝" Adj.	⅝" Adj.	13¾"	1 in 10"	1,379.99
(SA) 300 WSM	28"	035189248	023614064893	4	13 lbs.	47¾"	—	⅝" Adj.	⅝" Adj.	13¾"	1 in 10"	1,399.99
<b>A-BOLT TARGET STAINLESS</b>												
(SA) 223 Rem.	28"	035190208	023614064909	6	13 lbs. 4 oz.	47¾"	—	⅝" Adj.	⅝" Adj.	13¾"	1 in 8"	\$1,619.99
(SA) 308 Win.	28"	035190218	023614064916	5	13 lbs.	47¾"	—	⅝" Adj.	⅝" Adj.	13¾"	1 in 10"	1,619.99
(SA) 300 WSM	28"	035190248	023614064923	4	13 lbs.	47¾"	—	⅝" Adj.	⅝" Adj.	13¾"	1 in 10"	1,659.99

NOTE: \*Total capacity includes one round in the chamber. \*\*Weights listed are approximate. \*\*\*Measured from centerline of bore.



**A-BOLT ECLIPSE™ HUNTER WITH BOSS® ▶ SATIN FINISH LAMINATED STOCK**



**RECEIVER** - Steel · Matte blued finish · Glass bedded  
 · Drilled and tapped for scope mounts  
**BARREL** - Matte blued finish · Free-floating  
 · Hand chambered · Target crown  
**ACTION** - Bolt-action · 60° bolt lift · Non-rotating bolt sleeve · Adjustable trigger · Detachable box magazine  
 · Hinged floorplate · Top-tang safety

**STOCK** - Laminated gray satin finish  
 · Thumbhole grip · Monte Carlo cheekpiece · Checkered  
**FEATURES** - Sling swivel studs installed  
 · Recoil pad · BOSS® System

**A-BOLT M-1000 ECLIPSE™ ▶ SATIN FINISH LAMINATED STOCK**

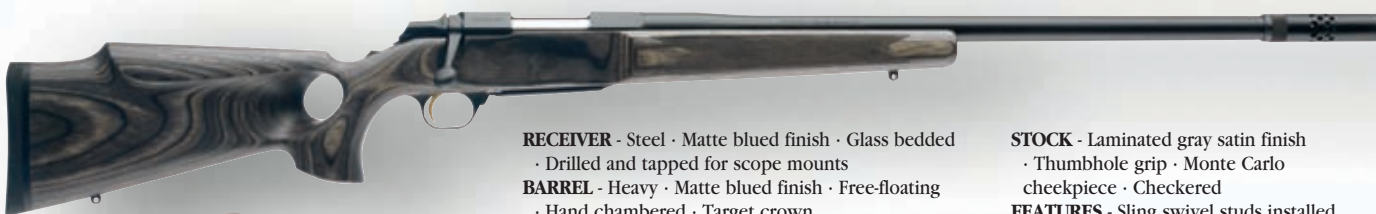

**RECEIVER** - Steel · Matte blued finish · Glass bedded  
 · Drilled and tapped for scope mounts  
**BARREL** - Heavy · Matte blued finish · Free-floating  
 · Hand chambered · Target crown  
**ACTION** - Bolt-action · 60° bolt lift · Non-rotating bolt sleeve · Adjustable trigger · Detachable box magazine  
 · Hinged floorplate · Top-tang safety

**STOCK** - Laminated gray satin finish  
 · Thumbhole grip · Monte Carlo cheekpiece · Checkered  
**FEATURES** - Sling swivel studs installed  
 · Recoil pad · BOSS® System optional

**A-BOLT STAINLESS M-1000 ECLIPSE™ ▶ SATIN FINISH LAMINATED STOCK**



**RECEIVER** - Stainless steel · Low luster finish · Glass bedded · Drilled and tapped for scope mounts  
**BARREL** - Heavy stainless steel · Low luster finish  
 · Free-floating · Hand chambered · Target crown  
**ACTION** - Bolt-action · 60° bolt lift · Non-rotating bolt sleeve · Adjustable stainless steel trigger · Detachable box magazine · Hinged floorplate · Top-tang safety

**STOCK** - Laminated gray satin finish  
 · Thumbhole grip · Monte Carlo cheekpiece · Checkered  
**FEATURES** - Sling swivel studs installed  
 · Recoil pad · BOSS® System optional

(SA) = Short Action, (LA) = Long Action

CALIBER	BARREL LENGTH	CODE NUMBER	UPC #	*TOTAL CAPACITY	**AVG. WEIGHT	OVERALL LENGTH	SIGHT RADIUS	***DROP AT COMB	DROP AT HEEL	LENGTH OF PULL	RATE OF TWIST	SUGG. RETAIL
<b>A-BOLT ECLIPSE HUNTER WITH BOSS</b>												
(LA) 270 Win.	22"	035005324	023614645269	5	7 lbs. 8 oz.	42¾"	—	¾"	½"	13¾"	1 in 10"	\$1,359.99
(LA) 30-06 Sprg.	22"	035005326	023614645276	5	7 lbs. 8 oz.	42¾"	—	¾"	½"	13¾"	1 in 10"	1,359.99
(LA) 7mm Rem. Mag.	26"	035005327	023614645283	4	7 lbs. 12 oz.	46¾"	—	¾"	½"	13¾"	1 in 9½"	1,389.99
<b>A-BOLT M-1000 ECLIPSE</b>												
(SA) 22-250 Rem.	26"	035007209	023614251491	5	9 lbs. 14 oz.	45¾"	—	⅝"	½"	13¾"	1 in 14"	\$1,269.99
(SA) 308 Win.	26"	035007218	023614251507	5	9 lbs. 14 oz.	45¾"	—	⅝"	½"	13¾"	1 in 12"	1,269.99
(SA) 270 WSM	26"	035007248	023614245896	4	9 lbs. 14 oz.	45¾"	—	⅝"	½"	13¾"	1 in 10"	1,299.99
(SA) 7mm WSM	26"	035007249	023614245933	4	9 lbs. 14 oz.	45¾"	—	⅝"	½"	13¾"	1 in 9½"	1,299.99
(SA) 300 WSM	26"	035007246	023614245919	4	9 lbs. 14 oz.	45¾"	—	⅝"	½"	13¾"	1 in 10"	1,299.99
<b>A-BOLT M-1000 ECLIPSE WITH BOSS (SHOWN)</b>												
(SA) 22-250 Rem.	26"	035007309	023614252467	5	10 lbs.	45¾"	—	⅝"	½"	13¾"	1 in 14"	\$1,359.99
(SA) 308 Win.	26"	035007318	023614252474	5	10 lbs.	45¾"	—	⅝"	½"	13¾"	1 in 12"	1,359.99
(SA) 270 WSM	26"	035007348	023614251422	4	10 lbs.	45¾"	—	⅝"	½"	13¾"	1 in 10"	1,389.99
(SA) 7mm WSM	26"	035007349	023614251439	4	10 lbs.	45¾"	—	⅝"	½"	13¾"	1 in 9½"	1,389.99
(SA) 300 WSM	26"	035007346	023614251446	4	10 lbs.	45¾"	—	⅝"	½"	13¾"	1 in 10"	1,389.99
(LA) 300 Win. Mag.	26"	035007329	023614074892	4	10 lbs.	46½"	—	⅝"	½"	13¾"	1 in 10"	1,389.99
<b>A-BOLT STAINLESS M-1000 ECLIPSE (SHOWN)</b>												
(SA) 22-250 Rem.	26"	035032209	023614251514	5	9 lbs. 14 oz.	45¾"	—	⅝"	½"	13¾"	1 in 14"	\$1,519.99
(SA) 308 Win.	26"	035032218	023614251521	5	9 lbs. 14 oz.	45¾"	—	⅝"	½"	13¾"	1 in 12"	1,519.99
(SA) 270 WSM	26"	035032248	023614245957	4	9 lbs. 14 oz.	45¾"	—	⅝"	½"	13¾"	1 in 10"	1,559.99
(SA) 7mm WSM	26"	035032249	023614246121	4	9 lbs. 14 oz.	45¾"	—	⅝"	½"	13¾"	1 in 9½"	1,559.99
(SA) 300 WSM	26"	035032246	023614246114	4	9 lbs. 14 oz.	45¾"	—	⅝"	½"	13¾"	1 in 10"	1,559.99
<b>A-BOLT STAINLESS M-1000 ECLIPSE WITH BOSS</b>												
(SA) 22-250 Rem.	26"	035032309	023614252504	5	10 lbs.	45¾"	—	⅝"	½"	13¾"	1 in 14"	\$1,619.99
(SA) 308 Win.	26"	035032318	023614252511	5	10 lbs.	45¾"	—	⅝"	½"	13¾"	1 in 12"	1,619.99
(SA) 270 WSM	26"	035032348	023614251392	4	10 lbs.	45¾"	—	⅝"	½"	13¾"	1 in 10"	1,659.99
(SA) 7mm WSM	26"	035032349	023614251408	4	10 lbs.	45¾"	—	⅝"	½"	13¾"	1 in 9½"	1,659.99
(SA) 300 WSM	26"	035032346	023614251415	4	10 lbs.	45¾"	—	⅝"	½"	13¾"	1 in 10"	1,659.99

NOTE: \*Total capacity includes one round in the chamber. \*\*Weights listed are approximate. \*\*\*Measured from centerline of bore.





**BOSS®-CR ACCESSORY**



The BOSS-CR accessory offers all the accuracy and tunable advantages of the original BOSS device without the muzzle brake feature. By simply replacing the original BOSS forward weight and recoil reduction components with the one-piece, no-hole BOSS-CR accessory, only the reduced recoil of the original BOSS is sacrificed. The BOSS-CR accessory is designed to fit only BAR Mark II and A-Bolt centerfire rifles previously factory-fitted with the BOSS.

GLOSS	MATTE	STAINLESS
BAR SAFARI AND THE FOLLOWING A-BOLT MODELS: MEDALLION GOLD MEDALLION	A-BOLT MODELS: COMPOSITE STALKER HUNTER EURO-BOLT VARMINT ECLIPSE HUNTER M-1000 ECLIPSE	A-BOLT MODELS: STAINLESS STALKER WHITE GOLD MEDALLION M-1000 ECLIPSE



**A-BOLT® EXTRA MAGAZINES**

CALIBER	CODE #	UPC #	SUGG. RETAIL
<b>EXTRA MAGAZINES (ALL RIFLE MODELS EXCEPT MICRO HUNTER)</b>			
222 Rem.	112022007	023614047490	\$69.99
204 Ruger	112022066	023614202974	69.99
22-250 Rem.	112022009	023614027072	69.99
223 Rem.	112022008	023614829324	69.99
223 WSSM	112022044	023614182429	69.99
223 Rem. SSA	112022060	023614316848	69.99
243 Win.	112022011	023614027089	69.99
243 WSSM	112022045	023614182436	69.99
270 WSM	112022035	023614180180	69.99
7mm-08 Rem.	112022016	023614027164	69.99
7mm WSM	112022036	023614180197	69.99
308 Win.	112022018	023614027126	69.99
300 WSM	112022034	023614179498	69.99
25 WSSM	112022049	023614199458	69.99
25-06 Rem.	112022023	023614027096	69.99
270 Win.	112022024	023614027102	69.99
280 Rem.	112022025	023614826835	69.99
30-06 Sprg.	112022026	023614027119	69.99
7mm Rem. Mag.	112022027	023614027133	69.99
300 Win. Mag.	112022029	023614027140	69.99
300 Ultra Mag.	112022030	023614179764	69.99
325 WSM	112022065	023614201816	69.99
338 Win. Mag.	112022031	023614027157	69.99
375 H&H Mag.	112022032	023614840121	69.99
338 Ultra Mag.	112022038	023614179757	69.99
<b>EXTRA MAGAZINES (MICRO HUNTER RIFLE)</b>			
22 Hornet	112023006	023614165668	\$69.99
22-250 Rem.	112023009	023614842965	69.99
243 Win.	112023011	023614842972	69.99
270 WSM	112023041	023614182405	69.99
7mm WSM	112023042	023614182412	69.99
7mm-08 Rem.	112023016	023614842996	69.99
308 Win.	112023018	023614842989	69.99
300 WSM	112023040	023614182399	69.99
325 WSM	11202304	023614204886	69.99
<b>EXTRA MAGAZINES (A-BOLT SHOTGUN)</b>			
<b>NEW</b> 12 Gauge	112022001	023614372707	\$69.99

NOTE: Magazines that are not listed above may be available only through the Browning Parts Department at (800) 322-4626.

CALIBER	CODE #	CODE #	CODE #
223 Rem.	1140011 023614645078	1140012 023614645085	1140013 023614645092
223 Varmint	1140061 023614645221	1140062 023614645238	—
223 WSSM	1140011 023614645078	1140012 023614645085	1140013 023614645092
243 WSSM	1140011 023614645078	1140012 023614645085	1140013 023614645092
25 WSSM	1140011 023614645078	1140012 023614645085	1140013 023614645092
22-250 Rem.	1140011 023614645078	1140012 023614645085	1140013 023614645092
22-250 Varmint	1140061 023614645221	1140062 023614645238	—
22-250 Varmint (M-1000)	—	1140062 023614645238	1140063 023614253013
243 Win.	1140011 023614645078	1140012 023614645085	1140013 023614645092
7mm-08 Rem.	1140011 023614645078	1140012 023614645085	1140013 023614645092
308 Win.	1140021 023614645108	1140022 023614645115	1140023 023614645122
308 Varmint	1140061 023614645221	1140062 023614645238	—
308 Varmint (M-1000)	—	1140062 023614645238	1140063 023614253013
25-06 Rem.	1140011 023614645078	1140012 023614645085	1140013 023614645092
260 Rem.	1140011 023614645078	1140012 023614645085	1140013 023614645092
270 WSM	1140021 023614645108	1140022 023614645115	1140023 023614645122
270 Win.	1140011 023614645078	1140012 023614645085	1140013 023614645092
280 Rem.	1140011 023614645078	1140012 023614645085	1140013 023614645092
30-06 Sprg.	1140031 023614645139	1140032 023614645146	1140033 023614645153
7mm WSM	1140021 023614645108	1140022 023614645115	1140023 023614645122
7mm Rem. Mag.	1140021 023614645108	1140022 023614645115	1140023 023614645122
300 WSM	1140041 023614645160	1140042 023614645177	1140043 023614645184
300 WSM (M-1000)	—	1140092 023614000433	1140093 023614253020
300 Win. Mag.	1140041 023614645160	1140042 023614645177	1140043 023614645184
300 Win. Mag. (M-1000)	—	1140092 023614000433	—
325 WSM	1140051 023614645191	1140052 023614645207	1140053 023614645214
338 Win. Mag.	1140051 023614645191	1140052 023614645207	1140053 023614645214
375 H&H Mag.	1140071 023614645245	—	1140073 023614645252

It is important that the correct BOSS-CR be selected for a specific caliber and model of rifle.

MODEL	SUGG. RETAIL
BOSS-CR, matte blue	\$39.99
BOSS-CR, gloss blue	39.99
BOSS-CR, stainless	39.99



# BLR

**A MODERN TWIST ON A CLASSIC STYLE.** John M. Browning designed many of the best lever-action rifles ever made. We're certain that the modern Browning BLR would have his nod of approval. The BLR features a rugged rack and pinion-driven bolt that locks tight to the barrel and gives the BLR accuracy potential that rivals many bolt-actions. A reliable box magazine protects bullet tips and gives the BLR magnum ability.



## ACTION

Advanced, lightning fast, glass-smooth rack and pinion lever-action. Strong rotating head, multiple-lug breech bolt with a recessed bolt face and side ejection.

## TRIGGER

Wide groove design trigger with short, smooth pull. The trigger travels with the lever to avoid pinching your fingers when cycling.



## MAGAZINE

The flush-mounted detachable box magazine has a capacity of three magnum or four standard rounds in the magazine, plus one in the chamber.



**TAKEDOWN FEATURES** BLR Takedown models are just as accurate and reliable as their unified counterparts but much easier to transport and store. The rifle is easily and quickly assembled without tools by simply sliding the barrel half into the receiver half and locking them together with the flip of a lever. The lever mechanically engages a stout locking lug into a recess in the bottom of the receiver. The system is rugged, precise and blends seamlessly into the styling of the rifle.

*All Browning firearms are shipped with a free locking device to assist in the safe storage of firearms.*



**HAMMER** The fold-down hammer has two positions at half-cock so the status of the rifle is readily seen. The folding hammer provides an added measure of safety when the hammer is at half-cock. The hammer has four basic positions: Full-cock, half-cock, folded hammer position and dropped, or fired position.



**RECEIVER** Lightweight, sturdy machined aircraft-grade aluminum. Drilled and tapped to accept scope mounts.

**SIGHTS** Low profile, square notch, screw adjustable rear sight aligns easily with a highly visible gold bead on raised ramp front sight.

**SCOPE MOUNTS** A scout-style scope mount is available as an accessory for the BLR Takedown models. This one-piece alloy base mounts forward of the receiver and stays attached to the barrel half of the rifle when disassembled to retain the scope's zero. A long eye-relief scope is required (not included). The receiver is also drilled and tapped for conventional scope bases and rings (not included). Three scout-style scope mounts are available for BLR Scout models, depending on the caliber (see chart on page 63).



**BLR LIGHTWEIGHT STAINLESS WITH PISTOL GRIP ▶ GLOSS FINISH STOCK AND FOREARM**



**RECEIVER** - Aircraft-grade alloy · Satin nickel finish · Drilled and tapped for scope mounts

**BARREL** - Matte stainless steel finish · Crowned muzzle · Adjustable sights

**ACTION** - Lever-action · Rotating bolt · Detachable box magazine

**STOCK** - Gloss finish walnut · Checkered pistol grip with Schnabel forearm

**FEATURES** - Sling swivel studs installed · Recoil pad

**BLR LIGHTWEIGHT '81 STAINLESS TAKEDOWN ▶ SATIN FINISH LAMINATED STOCK AND FOREARM**



**RECEIVER** - Aircraft-grade alloy · Satin nickel finish · Drilled and tapped for scope mounts

**BARREL** - Matte stainless steel finish · Crowned muzzle · Adjustable sights · Drilled and tapped for scope mount

**ACTION** - Lever-action · Rotating bolt · Detachable box magazine

**STOCK** - Satin finish gray laminate wood · Checkered straight grip

**FEATURES** - Recoil pad · Separates for storage or transportation · Optional scout-style scope mount · TRUGLO®/Marble's® fiber-optic front sight

(SA) = Short Action, (LA) = Long Action

CALIBER	BARREL LENGTH	CODE NUMBER	UPC #	*TOTAL CAPACITY	**AVG. WEIGHT	OVERALL LENGTH	SIGHT RADIUS	***DROP AT COMB	DROP AT HEEL	LENGTH OF PULL	RATE OF TWIST	SUGG. RETAIL
<b>BLR LIGHTWEIGHT STAINLESS WITH PISTOL GRIP, SHORT ACTION</b>												
(SA) 223 Rem.	20"	034018108	023614068006	5	6 lbs. 8 oz.	40"	17¾"	1"	1½"	13¾"	1 in 12"	\$1,019.99
(SA) 22-250 Rem.	20"	034018109	023614068013	5	6 lbs. 8 oz.	40"	17¾"	1"	1½"	13¾"	1 in 14"	1,019.99
(SA) 243 Win.	20"	034018111	023614066613	5	6 lbs. 8 oz.	40"	17¾"	1"	1½"	13¾"	1 in 10"	1,019.99
(SA) 7mm-08 Rem.	20"	034018116	023614068020	5	6 lbs. 8 oz.	40"	17¾"	1"	1½"	13¾"	1 in 9½"	1,019.99
(SA) 308 Win.	20"	034018118	023614066620	5	6 lbs. 8 oz.	40"	17¾"	1"	1½"	13¾"	1 in 12"	1,019.99
(SA) 358 Win.	20"	034018120	023614068037	5	6 lbs. 8 oz.	40"	17¾"	1"	1½"	13¾"	1 in 12"	1,019.99
(SA) 450 Marlin	20"	034018150	023614068044	4	7 lbs.	40"	17¾"	1"	1½"	13¾"	1 in 20"	1,019.99
(SA) 270 WSM	22"	034018148	023614066637	4	6 lbs. 12 oz.	42"	19¾"	1"	1½"	13¾"	1 in 10"	1,099.99
(SA) 7mm WSM	22"	034018149	023614068051	4	6 lbs. 12 oz.	42"	19¾"	1"	1½"	13¾"	1 in 9½"	1,099.99
(SA) 300 WSM	22"	034018146	023614066644	4	6 lbs. 12 oz.	42"	19¾"	1"	1½"	13¾"	1 in 10"	1,099.99
(SA) 325 WSM	22"	034018177	023614068068	4	6 lbs. 12 oz.	42"	19¾"	1"	1½"	13¾"	1 in 10"	1,099.99
<b>BLR LIGHTWEIGHT STAINLESS WITH PISTOL GRIP, LONG ACTION</b>												
(LA) 270 Win.	22"	034018124	023614068075	5	7 lbs. 4 oz.	43"	19¾"	¾"	1½"	14¼"	1 in 10"	\$1,069.99
(LA) 30-06 Sprg.	22"	034018126	023614068082	5	7 lbs. 4 oz.	43"	19¾"	¾"	1½"	14¼"	1 in 10"	1,069.99
(LA) 7mm Rem. Mag.	24"	034018127	023614068099	4	7 lbs. 12 oz.	45"	20"	¾"	1½"	14¼"	1 in 9½"	1,069.99
(LA) 300 Win. Mag.	24"	034018129	023614068105	4	7 lbs. 12 oz.	45"	20"	¾"	1½"	14¼"	1 in 10"	1,069.99
<b>BLR LIGHTWEIGHT '81 STAINLESS TAKEDOWN, SHORT ACTION</b>												
(SA) 223 Rem.	20"	034015108	023614068112	5	6 lbs. 8 oz.	40"	17¾"	1"	1½"	13¾"	1 in 12"	\$1,159.99
(SA) 22-250 Rem.	20"	034015109	023614259572	5	6 lbs. 8 oz.	40"	17¾"	1"	1½"	13¾"	1 in 14"	1,159.99
(SA) 243 Win.	20"	034015111	023614259589	5	6 lbs. 8 oz.	40"	17¾"	1"	1½"	13¾"	1 in 10"	1,159.99
(SA) 7mm-08 Rem.	20"	034015116	023614259596	5	6 lbs. 8 oz.	40"	17¾"	1"	1½"	13¾"	1 in 9½"	1,159.99
(SA) 308 Win.	20"	034015118	023614259602	5	6 lbs. 8 oz.	40"	17¾"	1"	1½"	13¾"	1 in 12"	1,159.99
(SA) 358 Win.	20"	034015120	023614259619	5	6 lbs. 8 oz.	40"	17¾"	1"	1½"	13¾"	1 in 12"	1,159.99
(SA) 450 Marlin	20"	034015150	023614259626	4	7 lbs.	40"	17¾"	1"	1½"	13¾"	1 in 20"	1,159.99
(SA) 270 WSM	22"	034015148	023614259633	4	6 lbs. 12 oz.	42"	19¾"	1"	1½"	13¾"	1 in 10"	1,239.99
(SA) 7mm WSM	22"	034015149	023614259640	4	6 lbs. 12 oz.	42"	19¾"	1"	1½"	13¾"	1 in 9½"	1,239.99
(SA) 300 WSM	22"	034015146	023614259657	4	6 lbs. 12 oz.	42"	19¾"	1"	1½"	13¾"	1 in 10"	1,239.99
(SA) 325 WSM	22"	034015177	023614259664	4	6 lbs. 12 oz.	42"	19¾"	1"	1½"	13¾"	1 in 10"	1,239.99
<b>BLR LIGHTWEIGHT '81 STAINLESS TAKEDOWN, LONG ACTION</b>												
(LA) 270 Win.	22"	034015124	023614259671	5	7 lbs. 4 oz.	43"	19¾"	¾"	1½"	14¼"	1 in 10"	\$1,219.99
(LA) 30-06 Sprg.	22"	034015126	023614259688	5	7 lbs. 4 oz.	43"	19¾"	¾"	1½"	14¼"	1 in 10"	1,219.99
(LA) 7mm Rem. Mag.	24"	034015127	023614259695	4	7 lbs. 12 oz.	45"	20"	¾"	1½"	14¼"	1 in 9½"	1,219.99
(LA) 300 Win. Mag.	24"	034015129	023614259701	4	7 lbs. 12 oz.	45"	20"	¾"	1½"	14¼"	1 in 10"	1,219.99

NOTE: \*Total capacity includes one round in the chamber. \*\*Weights listed are approximate. \*\*\*Measured from centerline of bore.



**BLR LIGHTWEIGHT TAKEDOWN WITH PISTOL GRIP ▶ GLOSS FINISH STOCK AND FOREARM**



**RECEIVER** - Aircraft-grade alloy  
 · Blued finish · Drilled and tapped  
 for scope mounts  
**BARREL** - Blued finish · Crowned  
 muzzle · Adjustable sights · Drilled and  
 tapped for scout mount

**ACTION** - Lever-action · Rotating bolt  
 · Detachable box magazine  
**STOCK** - Gloss finish walnut · Checkered  
 pistol grip with Schnabel forearm  
**FEATURES** - Sling swivel studs installed  
 · Recoil pad · Separates for storage  
 or transportation · Optional scout-style  
 scope mount

**BLR LIGHTWEIGHT TAKEDOWN SCOUT-STYLE SCOPE MOUNT**

DESCRIPTION	CODE #	SUGG. RETAIL	FEATURES
Short Action Mount	12327	\$69.99	· Aircraft-grade alloy · Blued finish
WSM/Long Action/Magnum Mount	12326	69.99	· One-piece design
450 Marlin Mount	12325	69.99	· Easy installation



Scout Style Scope Mount

**BLR LIGHTWEIGHT WITH PISTOL GRIP ▶ GLOSS FINISH STOCK AND FOREARM**



**RECEIVER** - Aircraft-grade alloy  
 · Blued finish · Drilled and tapped  
 for scope mounts  
**BARREL** - Blued finish · Crowned  
 muzzle · Adjustable sights

**ACTION** - Lever-action · Rotating bolt  
 · Detachable box magazine  
**STOCK** - Gloss finish walnut · Checkered  
 pistol grip with Schnabel forearm  
**FEATURES** - Sling swivel studs installed  
 · Recoil pad

(SA) = Short Action, (LA) = Long Action

CALIBER	BARREL LENGTH	CODE NUMBER	UPC #	*TOTAL CAPACITY	**AVG. WEIGHT	OVERALL LENGTH	SIGHT RADIUS	***DROP AT COMB	DROP AT HEEL	LENGTH OF PULL	RATE OF TWIST	SUGG. RETAIL
<b>BLR LIGHTWEIGHT TAKEDOWN WITH PISTOL GRIP, SHORT ACTION</b>												
(SA) 223 Rem.	20"	034012108	023614068174	5	6 lbs. 8 oz.	40"	17¾"	⅞"	⅛"	13¾"	1 in 12"	\$1,019.99
(SA) 22-250 Rem.	20"	034012109	023614255239	5	6 lbs. 8 oz.	40"	17¾"	⅞"	⅛"	13¾"	1 in 14"	1,019.99
(SA) 243 Win.	20"	034012111	023614255246	5	6 lbs. 8 oz.	40"	17¾"	⅞"	⅛"	13¾"	1 in 10"	1,019.99
(SA) 7mm-08 Rem.	20"	034012116	023614255253	5	6 lbs. 8 oz.	40"	17¾"	⅞"	⅛"	13¾"	1 in 9½"	1,019.99
(SA) 308 Win.	20"	034012118	023614255260	5	6 lbs. 8 oz.	40"	17¾"	⅞"	⅛"	13¾"	1 in 12"	1,019.99
(SA) 358 Win.	20"	034012120	023614255277	5	6 lbs. 8 oz.	40"	17¾"	⅞"	⅛"	13¾"	1 in 12"	1,019.99
(SA) 450 Marlin	20"	034012150	023614255284	4	7 lbs.	40"	17¾"	⅞"	⅛"	13¾"	1 in 20"	1,019.99
(SA) 270 WSM	22"	034012148	023614255291	4	6 lbs. 12 oz.	42"	19¾"	⅞"	⅛"	13¾"	1 in 10"	1,099.99
(SA) 7mm WSM	22"	034012149	023614255307	4	6 lbs. 12 oz.	42"	19¾"	⅞"	⅛"	13¾"	1 in 9½"	1,099.99
(SA) 300 WSM	22"	034012146	023614255314	4	6 lbs. 12 oz.	42"	19¾"	⅞"	⅛"	13¾"	1 in 10"	1,099.99
(SA) 325 WSM	22"	034012177	023614255321	4	6 lbs. 12 oz.	42"	19¾"	⅞"	⅛"	13¾"	1 in 10"	1,099.99
<b>BLR LIGHTWEIGHT TAKEDOWN WITH PISTOL GRIP, LONG ACTION</b>												
(LA) 270 Win.	22"	034012124	023614255338	5	7 lbs. 4 oz.	43"	19¾"	1"	1"	14¼"	1 in 10"	\$1,069.99
(LA) 30-06 Sprg.	22"	034012126	023614255345	5	7 lbs. 4 oz.	43"	19¾"	1"	1"	14¼"	1 in 10"	1,069.99
(LA) 7mm Rem. Mag.	24"	034012127	023614255352	4	7 lbs. 12 oz.	45"	20"	1"	1"	14¼"	1 in 9½"	1,069.99
(LA) 300 Win. Mag.	24"	034012129	023614255369	4	7 lbs. 12 oz.	45"	20"	1"	1"	14¼"	1 in 10"	1,069.99
<b>BLR LIGHTWEIGHT WITH PISTOL GRIP, SHORT ACTION</b>												
(SA) 223 Rem.	20"	034009108	023614068167	5	6 lbs. 8 oz.	40"	17¾"	⅞"	⅛"	13¾"	1 in 12"	\$939.99
(SA) 22-250 Rem.	20"	034009109	023614250012	5	6 lbs. 8 oz.	40"	17¾"	⅞"	⅛"	13¾"	1 in 14"	939.99
(SA) 243 Win.	20"	034009111	023614250029	5	6 lbs. 8 oz.	40"	17¾"	⅞"	⅛"	13¾"	1 in 10"	939.99
(SA) 7mm-08 Rem.	20"	034009116	023614250036	5	6 lbs. 8 oz.	40"	17¾"	⅞"	⅛"	13¾"	1 in 9½"	939.99
(SA) 308 Win.	20"	034009118	023614250043	5	6 lbs. 8 oz.	40"	17¾"	⅞"	⅛"	13¾"	1 in 12"	939.99
(SA) 358 Win.	20"	034009120	023614250050	5	6 lbs. 8 oz.	40"	17¾"	⅞"	⅛"	13¾"	1 in 12"	939.99
(SA) 450 Marlin	20"	034009150	023614250067	4	7 lbs.	40"	17¾"	⅞"	⅛"	13¾"	1 in 20"	939.99
(SA) 270 WSM	22"	034009148	023614250074	4	6 lbs. 12 oz.	42"	19¾"	⅞"	⅛"	13¾"	1 in 10"	1,019.99
(SA) 7mm WSM	22"	034009149	023614250081	4	6 lbs. 12 oz.	42"	19¾"	⅞"	⅛"	13¾"	1 in 9½"	1,019.99
(SA) 300 WSM	22"	034009146	023614250098	4	6 lbs. 12 oz.	42"	19¾"	⅞"	⅛"	13¾"	1 in 10"	1,019.99
(SA) 325 WSM	22"	034009177	023614250104	4	6 lbs. 12 oz.	42"	19¾"	⅞"	⅛"	13¾"	1 in 10"	1,019.99
<b>BLR LIGHTWEIGHT WITH PISTOL GRIP, LONG ACTION</b>												
(LA) 270 Win.	22"	034009124	023614249979	5	7 lbs. 4 oz.	43"	19¾"	1"	1"	14¼"	1 in 10"	\$989.99
(LA) 30-06 Sprg.	22"	034009126	023614249986	5	7 lbs. 4 oz.	43"	19¾"	1"	1"	14¼"	1 in 10"	989.99
(LA) 7mm Rem. Mag.	24"	034009127	023614249993	4	7 lbs. 12 oz.	45"	20"	1"	1"	14¼"	1 in 9½"	989.99
(LA) 300 Win. Mag.	24"	034009129	023614250005	4	7 lbs. 12 oz.	45"	20"	1"	1"	14¼"	1 in 10"	989.99

NOTE: \*Total capacity includes one round in the chamber. \*\*Weights listed are approximate. \*\*\*Measured from centerline of bore.



**BLR LIGHTWEIGHT '81 TAKEDOWN** ▶ GLOSS FINISH STOCK AND FOREARM



**RECEIVER** - Aircraft-grade alloy  
· Blued finish · Drilled and tapped for scope mounts

**BARREL** - Blued finish · Crowned muzzle · Adjustable sights · Drilled and tapped for scout mount

**ACTION** - Lever-action · Rotating bolt · Detachable box magazine

**STOCK** - Gloss finish walnut  
· Checkered · Straight grip

**FEATURES** - Recoil pad · Separates for storage or transportation  
· Optional scout-style scope mount (Scope and mounts not included)

**BLR LIGHTWEIGHT '81** ▶ GLOSS FINISH STOCK AND FOREARM



**RECEIVER** - Aircraft-grade alloy  
· Blued finish · Drilled and tapped for scope mounts

**BARREL** - Blued finish · Crowned muzzle · Adjustable sights

**ACTION** - Lever-action · Rotating bolt · Detachable box magazine

**STOCK** - Gloss finish walnut  
· Checkered · Straight grip  
**FEATURES** - Recoil pad

(SA) = Short Action, (LA) = Long Action

CALIBER	BARREL LENGTH	CODE NUMBER	UPC #	*TOTAL CAPACITY	**AVG. WEIGHT	OVERALL LENGTH	SIGHT RADIUS	***DROP AT COMB	DROP AT HEEL	LENGTH OF PULL	RATE OF TWIST	SUGG. RETAIL
<b>BLR LIGHTWEIGHT '81 TAKEDOWN, SHORT ACTION</b>												
(SA) 223 Rem.	20"	034011108	023614068150	5	6 lbs. 8 oz.	40"	17¾"	7/8"	15/16"	13¾"	1 in 12"	\$979.99
(SA) 22-250 Rem.	20"	034011109	023614255376	5	6 lbs. 8 oz.	40"	17¾"	7/8"	15/16"	13¾"	1 in 14"	979.99
(SA) 243 Win.	20"	034011111	023614255383	5	6 lbs. 8 oz.	40"	17¾"	7/8"	15/16"	13¾"	1 in 10"	979.99
(SA) 7mm-08 Rem.	20"	034011116	023614255390	5	6 lbs. 8 oz.	40"	17¾"	7/8"	15/16"	13¾"	1 in 9½"	979.99
(SA) 308 Win.	20"	034011118	023614255406	5	6 lbs. 8 oz.	40"	17¾"	7/8"	15/16"	13¾"	1 in 12"	979.99
(SA) 358 Win.	20"	034011120	023614255413	5	6 lbs. 8 oz.	40"	17¾"	7/8"	15/16"	13¾"	1 in 12"	979.99
(SA) 450 Marlin	20"	034011150	023614255420	4	7 lbs.	40"	17¾"	7/8"	15/16"	13¾"	1 in 20"	979.99
(SA) 270 WSM	22"	034011148	023614255437	4	6 lbs. 12 oz.	42"	19¾"	7/8"	15/16"	13¾"	1 in 10"	1,059.99
(SA) 7mm WSM	22"	034011149	023614255444	4	6 lbs. 12 oz.	42"	19¾"	7/8"	15/16"	13¾"	1 in 9½"	1,059.99
(SA) 300 WSM	22"	034011146	023614255451	4	6 lbs. 12 oz.	42"	19¾"	7/8"	15/16"	13¾"	1 in 10"	1,059.99
(SA) 325 WSM	22"	034011177	023614255468	4	6 lbs. 12 oz.	42"	19¾"	7/8"	15/16"	13¾"	1 in 10"	1,059.99
<b>BLR LIGHTWEIGHT '81 TAKEDOWN, LONG ACTION</b>												
(LA) 270 Win.	22"	034011124	023614255475	5	7 lbs. 4 oz.	43"	19¾"	1"	13/8"	14¼"	1 in 10"	\$1,029.99
(LA) 30-06 Sprg.	22"	034011126	023614255482	5	7 lbs. 4 oz.	43"	19¾"	1"	13/8"	14¼"	1 in 10"	1,029.99
(LA) 7mm Rem. Mag.	24"	034011127	023614255499	4	7 lbs. 12 oz.	45"	20"	1"	13/8"	14¼"	1 in 9½"	1,029.99
(LA) 300 Win. Mag.	24"	034011129	023614255505	4	7 lbs. 12 oz.	45"	20"	1"	13/8"	14¼"	1 in 10"	1,029.99
<b>BLR LIGHTWEIGHT '81, SHORT ACTION</b>												
(SA) 223 Rem.	20"	034006108	023614068143	5	6 lbs. 8 oz.	40"	17¾"	7/8"	15/16"	13¾"	1 in 12"	\$899.99
(SA) 22-250 Rem.	20"	034006109	023614240624	5	6 lbs. 8 oz.	40"	17¾"	7/8"	15/16"	13¾"	1 in 14"	899.99
(SA) 243 Win.	20"	034006111	023614240631	5	6 lbs. 8 oz.	40"	17¾"	7/8"	15/16"	13¾"	1 in 10"	899.99
(SA) 7mm-08 Rem.	20"	034006116	023614240648	5	6 lbs. 8 oz.	40"	17¾"	7/8"	15/16"	13¾"	1 in 9½"	899.99
(SA) 308 Win.	20"	034006118	023614240655	5	6 lbs. 8 oz.	40"	17¾"	7/8"	15/16"	13¾"	1 in 12"	899.99
(SA) 358 Win.	20"	034006120	023614240617	5	6 lbs. 8 oz.	40"	17¾"	7/8"	15/16"	13¾"	1 in 12"	899.99
(SA) 450 Marlin	20"	034006150	023614241638	4	7 lbs.	40"	17¾"	7/8"	15/16"	13¾"	1 in 20"	899.99
(SA) 270 WSM	22"	034006148	023614240662	4	6 lbs. 12 oz.	42"	19¾"	7/8"	15/16"	13¾"	1 in 10"	979.99
(SA) 7mm WSM	22"	034006149	023614240679	4	6 lbs. 12 oz.	42"	19¾"	7/8"	15/16"	13¾"	1 in 9½"	979.99
(SA) 300 WSM	22"	034006146	023614240686	4	6 lbs. 12 oz.	42"	19¾"	7/8"	15/16"	13¾"	1 in 10"	979.99
(SA) 325 WSM	22"	034006177	023614250463	4	6 lbs. 12 oz.	42"	19¾"	7/8"	15/16"	13¾"	1 in 10"	979.99
<b>BLR LIGHTWEIGHT '81, LONG ACTION</b>												
(LA) 270 Win.	22"	034006124	023614240341	5	7 lbs. 4 oz.	43"	19¾"	1"	13/8"	14¼"	1 in 10"	\$949.99
(LA) 30-06 Sprg.	22"	034006126	023614240365	5	7 lbs. 4 oz.	43"	19¾"	1"	13/8"	14¼"	1 in 10"	949.99
(LA) 7mm Rem. Mag.	24"	034006127	023614240372	4	7 lbs. 12 oz.	45"	20"	1"	13/8"	14¼"	1 in 9½"	949.99
(LA) 300 Win. Mag.	24"	034006129	023614240600	4	7 lbs. 12 oz.	45"	20"	1"	13/8"	14¼"	1 in 10"	949.99

NOTE: \*Total capacity includes one round in the chamber. \*\*Weights listed are approximate. \*\*\*Measured from centerline of bore.

**BLR EXTRA MAGAZINES**

CALIBER	CODE NUMBER	UPC #	SUGG. RETAIL	CALIBER	CODE NUMBER	UPC #	SUGG. RETAIL
<b>EXTRA MAGAZINES, SHORT ACTION CALIBERS</b>				<b>EXTRA MAGAZINES, LONG AND SHORT ACTION CALIBERS</b>			
223 Rem.	112026008	023614038061	\$69.99	270 Win.	112026024	023614165620	\$69.99
243 Win.	112026011	023614027195	69.99	30-06 Sprg.	112026026	023614165637	69.99
308 Win.	112026012	023614183983	69.99	7mm Rem. Mag.	112026027	023614165644	69.99
22-250 Rem.	112026009	023614027188	69.99	300 Win. Mag.	112026029	023614075080	69.99
7mm-08 Rem.	112026016	023614027201	69.99	325 WSM	112022067	023614201823	69.99
270 WSM	112026030	023614182443	69.99	358 Win.	112026042	023614182474	69.99
300 WSM	112026041	023614182467	69.99	450 Marlin	112026043	023614182481	69.99
7mm WSM	112026031	023614182450	69.99				





# BAR

## BAR MEANS AUTOLOADER ACCURACY.

There was a time when accuracy was often marginal from autoloading rifles. Those days ended the day the Browning BAR was introduced. The accurate, fast handling and dependable BAR features a multi-lug rotary bolt that secures the bolt to the barrel for superb accuracy and offers the strength to fire magnum cartridges. The piston-operated gas system softens felt recoil and reduces muzzle climb.



## RECEIVER

The Safari model uses a richly blued one-piece ordnance steel receiver with scroll engraving. Stalker, ShortTrac® and LongTrac® models have an aircraft-grade aluminum alloy receiver. All BAR rifles are drilled and tapped for scope mounts. The bolt release lever is incorporated into the receiver.



## ACTION

The BAR is a gas-operated autoloader with a high-strength, multiple-lug rotating bolt that locks directly into the barrel. Every cartridge loaded into the chamber of the BAR is surrounded by a recessed bolt face, which is encircled by the barrel and then surrounded by the receiver. A seven-lug bolt and precise breech-to-chamber relationship give the BAR exceptional accuracy and the strength to handle magnum loads. The strong and very rigid action bar/inertia block link-up improves accuracy by reducing barrel vibration. The buffering system reduces wear and stress on the rifle's mechanism.

*All Browning firearms are shipped with a free locking device to assist in the safe storage of firearms.*





### MAGAZINE

Detachable box magazine with a unique hinged floorplate allows you to lower the floorplate, detach the empty magazine and snap in a full magazine in seconds.



### ADJUSTABLE SHIM SYSTEM

ShortTrac® and LongTrac® BAR rifles include six shims that let you customize the drop at comb and cast on/off of the rifle to your ideal dimensions.



### MAXIMUM GRIP

Camo composite BAR models combine checkered or overmolded gripping surfaces and Browning's proven Dura-Touch® Armor Coating for a sure hold and a sleek feel in all climate conditions.



### THE BOSS® SYSTEM

The Ballistic Optimizing Shooting System is designed to squeeze maximum accuracy from the BAR. The tunable BOSS System easily dials-in barrel harmonics to precisely match the specific ammunition being fired to deliver amazingly tight groups. The BOSS System is available as an option on the BAR MK II Safari.

### BOSS-CR

The BOSS-CR offers all the accuracy advantages of the original BOSS without the muzzle brake feature.



**BAR LONGTRAC®** ▶ OIL FINISH STOCK AND FOREARM

BAR LongTrac, Left-Hand

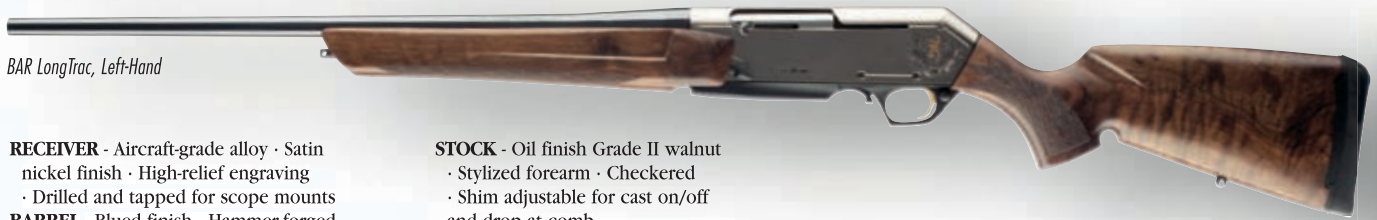

**RECEIVER** - Aircraft-grade alloy · Satin nickel finish · High-relief engraving  
 · Drilled and tapped for scope mounts  
**BARREL** - Blued finish · Hammer-forged  
**ACTION** - Gas-operated autoloader  
 · Multi-lug rotary bolt · Detachable box magazine · Composite trigger guard and floorplate · Crossbolt safety

**STOCK** - Oil finish Grade II walnut  
 · Stylized forearm · Checkered  
 · Shim adjustable for cast on/off and drop at comb  
**FEATURES** - Sling swivel studs installed  
 · Interchangeable recoil pad



BAR LongTrac, Right-Hand

**BAR SHORTTRAC®** ▶ OIL FINISH STOCK AND FOREARM

BAR ShortTrac, Left-Hand



**RECEIVER** - Aircraft-grade alloy · Satin nickel finish · High-relief engraving  
 · Drilled and tapped for scope mounts  
**BARREL** - Blued finish · Hammer-forged  
**ACTION** - Gas-operated autoloader  
 · Multi-lug rotary bolt · Detachable box magazine · Composite trigger guard and floorplate · Crossbolt safety

**STOCK** - Oil finish Grade II walnut  
 · Stylized forearm · Checkered  
 · Shim adjustable for cast on/off and drop at comb  
**FEATURES** - Sling swivel studs installed  
 · Interchangeable recoil pad



BAR ShortTrac, Right-Hand

(SA) = Short Action, (LA) = Long Action

CALIBER	BARREL LENGTH	CODE NUMBER	UPC #	*TOTAL CAPACITY	**AVG. WEIGHT	OVERALL LENGTH	SIGHT RADIUS	***DROP AT COMB	DROP AT HEEL	LENGTH OF PULL	RATE OF TWIST	SUGG. RETAIL
<b>BAR LONGTRAC, LEFT-HAND</b>												
(LA) 270 Win.	22"	031537224	023614064831	5	6 lbs. 15 oz.	43"	—	5/8"	1 1/8"	13 3/8"	1 in 10"	\$1,189.99
(LA) 30-06 Sprg.	22"	031537226	023614064848	5	6 lbs. 15 oz.	43"	—	5/8"	1 1/8"	13 3/8"	1 in 10"	1,189.99
(LA) 7mm Rem. Mag.	24"	031537227	023614064855	4	7 lbs. 8 oz.	45"	—	5/8"	1 1/8"	13 3/8"	1 in 9 1/2"	1,279.99
(LA) 300 Win. Mag.	24"	031537229	023614064862	4	7 lbs. 8 oz.	45"	—	5/8"	1 1/8"	13 3/8"	1 in 10"	1,279.99
<b>BAR LONGTRAC, RIGHT-HAND</b>												
(LA) 270 Win.	22"	031536224	023614064794	5	6 lbs. 15 oz.	43"	—	5/8"	1 1/8"	13 3/8"	1 in 10"	\$1,139.99
(LA) 30-06 Sprg.	22"	031536226	023614064800	5	6 lbs. 15 oz.	43"	—	5/8"	1 1/8"	13 3/8"	1 in 10"	1,139.99
(LA) 7mm Rem. Mag.	24"	031536227	023614064817	4	7 lbs. 8 oz.	45"	—	5/8"	1 1/8"	13 3/8"	1 in 9 1/2"	1,239.99
(LA) 300 Win. Mag.	24"	031536229	023614064824	4	7 lbs. 8 oz.	45"	—	5/8"	1 1/8"	13 3/8"	1 in 10"	1,239.99
<b>BAR SHORTTRAC, LEFT-HAND</b>												
(SA) 243 Win.	22"	031535211	023614064725	5	6 lbs. 10 oz.	42 3/4"	—	5/8"	1 1/8"	13 1/4"	1 in 10"	\$1,189.99
(SA) 7mm-08 Rem.	22"	031535216	023614064749	5	6 lbs. 10 oz.	42 3/4"	—	5/8"	1 1/8"	13 1/4"	1 in 9 1/2"	1,189.99
(SA) 308 Win.	22"	031535218	023614064732	5	6 lbs. 10 oz.	42 3/4"	—	5/8"	1 1/8"	13 1/4"	1 in 12"	1,189.99
(SA) 270 WSM	23"	031535248	023614064756	4	7 lbs. 4 oz.	43 3/4"	—	5/8"	1 1/8"	13 1/4"	1 in 10"	1,279.99
(SA) 7mm WSM	23"	031535249	023614064763	4	7 lbs. 4 oz.	43 3/4"	—	5/8"	1 1/8"	13 1/4"	1 in 9 1/2"	1,279.99
(SA) 300 WSM	23"	031535246	023614064770	4	7 lbs. 4 oz.	43 3/4"	—	5/8"	1 1/8"	13 1/4"	1 in 10"	1,279.99
(SA) 325 WSM	23"	031535277	023614064787	4	7 lbs. 4 oz.	43 3/4"	—	5/8"	1 1/8"	13 1/4"	1 in 10"	1,279.99
<b>BAR SHORTTRAC, RIGHT-HAND</b>												
(SA) 243 Win.	22"	031534211	023614064657	5	6 lbs. 10 oz.	42 3/4"	—	5/8"	1 1/8"	13 1/4"	1 in 10"	\$1,139.99
(SA) 7mm-08 Rem.	22"	031534216	023614064671	5	6 lbs. 10 oz.	42 3/4"	—	5/8"	1 1/8"	13 1/4"	1 in 9 1/2"	1,139.99
(SA) 308 Win.	22"	031534218	023614064664	5	6 lbs. 10 oz.	42 3/4"	—	5/8"	1 1/8"	13 1/4"	1 in 12"	1,139.99
(SA) 270 WSM	23"	031534248	023614064688	4	7 lbs. 4 oz.	43 3/4"	—	5/8"	1 1/8"	13 1/4"	1 in 10"	1,239.99
(SA) 7mm WSM	23"	031534249	023614064695	4	7 lbs. 4 oz.	43 3/4"	—	5/8"	1 1/8"	13 1/4"	1 in 9 1/2"	1,239.99
(SA) 300 WSM	23"	031534246	023614064701	4	7 lbs. 4 oz.	43 3/4"	—	5/8"	1 1/8"	13 1/4"	1 in 10"	1,239.99
(SA) 325 WSM	23"	031534277	023614064718	4	7 lbs. 4 oz.	43 3/4"	—	5/8"	1 1/8"	13 1/4"	1 in 10"	1,239.99

NOTE: \*Total capacity includes one round in the chamber. \*\*Weights listed are approximate. \*\*\*Measured from centerline of bore.



**BAR SHORTTRAC®, MOSSY OAK® BREAK-UP® INFINITY™ ▶ DURA-TOUCH® ARMOR COATING ON STOCK AND FOREARM**



**SHORT TRAC**



**DURA-TOUCH®**  
Armor Coating



**RECEIVER** - Aircraft-grade alloy  
· Drilled and tapped for scope mounts  
**BARREL** - Hammer-forged  
**ACTION** - Gas-operated autoloader  
· Multi-lug rotary bolt · Detachable box magazine · Composite trigger guard and floorplate · Crossbolt safety

**STOCK** - Composite · Dura-Touch® Armor Coating · Mossy Oak® Break-Up® Infinity™ camo finish · Gripping panels · Shim adjustable for cast on/off and drop at comb  
**FEATURES** - Sling swivel studs installed · Interchangeable recoil pad

**BAR LONGTRAC®, MOSSY OAK® BREAK-UP® INFINITY™ ▶ DURA-TOUCH® ARMOR COATING ON STOCK AND FOREARM**



**DURA-TOUCH®**  
Armor Coating

**LONG TRAC**

**RECEIVER** - Aircraft-grade alloy  
· Drilled and tapped for scope mounts  
**BARREL** - Hammer-forged  
**ACTION** - Gas-operated autoloader  
· Multi-lug rotary bolt · Detachable box magazine · Composite trigger guard and floorplate · Crossbolt safety

**STOCK** - Composite · Dura-Touch® Armor Coating · Mossy Oak® Break-Up® Infinity™ camo finish · Gripping panels · Shim adjustable for cast on/off and drop at comb  
**FEATURES** - Sling swivel studs installed · Interchangeable recoil pad

(SA) = Short Action, (LA) = Long Action

CALIBER	BARREL LENGTH	CODE NUMBER	UPC #	*TOTAL CAPACITY	**AVG. WEIGHT	OVERALL LENGTH	SIGHT RADIUS	***DROP AT COMB	DROP AT HEEL	LENGTH OF PULL	RATE OF TWIST	SUGG. RETAIL
<b>BAR SHORTTRAC, MOSSY OAK BREAK-UP INFINITY</b>												
(SA) 243 Win.	22"	031022211	023614068679	5	6 lbs. 10 oz.	41½"	—	⅝"	1⅛"	13⅝"	1 in 10"	\$1,279.99
(SA) 7mm-08 Rem.	22"	031022216	023614068693	5	6 lbs. 10 oz.	41½"	—	⅝"	1⅛"	13⅝"	1 in 9½"	1,279.99
(SA) 308 Win.	22"	031022218	023614068686	5	6 lbs. 10 oz.	41½"	—	⅝"	1⅛"	13⅝"	1 in 12"	1,279.99
(SA) 270 WSM	23"	031022248	023614068709	4	7 lbs. 4 oz.	42½"	—	⅝"	1⅛"	13⅝"	1 in 10"	1,389.99
(SA) 7mm WSM	23"	031022249	023614068716	4	7 lbs. 4 oz.	42½"	—	⅝"	1⅛"	13⅝"	1 in 9½"	1,389.99
(SA) 300 WSM	23"	031022246	023614068723	4	7 lbs. 4 oz.	42½"	—	⅝"	1⅛"	13⅝"	1 in 10"	1,389.99
(SA) 325 WSM	23"	031022277	023614068730	4	7 lbs. 4 oz.	42½"	—	⅝"	1⅛"	13⅝"	1 in 10"	1,389.99
<b>BAR LONGTRAC, MOSSY OAK BREAK-UP INFINITY</b>												
(LA) 270 Win.	22"	031023224	023614068747	5	6 lbs. 15 oz.	42"	—	⅝"	1⅛"	13⅝"	1 in 10"	\$1,279.99
(LA) 30-06 Sprg.	22"	031023226	023614068754	5	6 lbs. 15 oz.	42"	—	⅝"	1⅛"	13⅝"	1 in 10"	1,279.99
(LA) 7mm Rem. Mag.	24"	031023227	023614068761	4	7 lbs. 8 oz.	44"	—	⅝"	1⅛"	13⅝"	1 in 9½"	1,389.99
(LA) 300 Win. Mag.	24"	031023229	023614068778	4	7 lbs. 8 oz.	44"	—	⅝"	1⅛"	13⅝"	1 in 10"	1,389.99
<b>BAR SHORTTRAC STALKER</b>												
(SA) 243 Win.	22"	031330211	023614252207	5	6 lbs. 10 oz.	41½"	—	⅝"	1⅛"	13⅝"	1 in 10"	\$1,159.99
(SA) 7mm-08 Rem.	22"	031330216	023614064633	5	6 lbs. 10 oz.	41½"	—	⅝"	1⅛"	13⅝"	1 in 9½"	1,159.99
(SA) 308 Win.	22"	031330218	023614252214	5	6 lbs. 10 oz.	41½"	—	⅝"	1⅛"	13⅝"	1 in 12"	1,159.99
(SA) 270 WSM	23"	031330248	023614252221	4	7 lbs. 4 oz.	42½"	—	⅝"	1⅛"	13⅝"	1 in 10"	1,259.99
(SA) 7mm WSM	23"	031330249	023614252238	4	7 lbs. 4 oz.	42½"	—	⅝"	1⅛"	13⅝"	1 in 9½"	1,259.99
(SA) 300 WSM	23"	031330246	023614252245	4	7 lbs. 4 oz.	42½"	—	⅝"	1⅛"	13⅝"	1 in 10"	1,259.99
(SA) 325 WSM	23"	031330277	023614064640	4	7 lbs. 4 oz.	42½"	—	⅝"	1⅛"	13⅝"	1 in 10"	1,259.99
<b>BAR LONGTRAC STALKER</b>												
(LA) 270 Win.	22"	031331224	023614252252	5	6 lbs. 15 oz.	42"	—	⅝"	1⅛"	13⅝"	1 in 10"	\$1,159.99
(LA) 30-06 Sprg.	22"	031331226	023614252269	5	6 lbs. 15 oz.	42"	—	⅝"	1⅛"	13⅝"	1 in 10"	1,159.99
(LA) 7mm Rem. Mag.	24"	031331227	023614252276	4	7 lbs. 8 oz.	44"	—	⅝"	1⅛"	13⅝"	1 in 9½"	1,259.99
(LA) 300 Win. Mag.	24"	031331229	023614252283	4	7 lbs. 8 oz.	44"	—	⅝"	1⅛"	13⅝"	1 in 10"	1,259.99

NOTE: \*Total capacity includes one round in the chamber. \*\*Weights listed are approximate. \*\*\*Measured from centerline of bore.



**BAR SHORTTRAC® STALKER** ▶ NON-GLARE COMPOSITE FINISH STOCK AND FOREARM



**SHORT TRAC**



**RECEIVER** - Aircraft-grade alloy · Matte blued finish · Drilled and tapped for scope mounts  
**BARREL** - Matte blued finish · Hammer-forged  
**ACTION** - Gas-operated autoloader · Multi-lug rotary bolt · Detachable box magazine  
 · Composite trigger guard and floorplate  
 · Crossbolt safety

**STOCK** - Composite · Matte black finish  
 · Gripping panels · Shim adjustable for cast on/off and drop at comb  
**FEATURES** - Sling swivel studs installed  
 · Interchangeable recoil pad

**BAR LONGTRAC® STALKER** ▶ NON-GLARE COMPOSITE FINISH STOCK AND FOREARM



**LONG TRAC**

**RECEIVER** - Aircraft-grade alloy · Matte blued finish · Drilled and tapped for scope mounts  
**BARREL** - Matte blued finish · Hammer-forged  
**ACTION** - Gas-operated autoloader · Multi-lug rotary bolt · Detachable box magazine  
 · Composite trigger guard and floorplate  
 · Crossbolt safety

**STOCK** - Composite · Matte black finish  
 · Gripping panels · Shim adjustable for cast on/off and drop at comb  
**FEATURES** - Sling swivel studs installed  
 · Interchangeable recoil pad



**BAR SHORTTRAC® AND LONGTRAC® RECOIL PADS** (FOR WOOD AND COMPOSITE MODELS)

DESCRIPTION	CODE #	UPC #	SUGG. RETAIL
½" BAR ST/LT Recoil Pad	11450	023614203933	\$29.99
¾" BAR ST/LT Recoil Pad	11451	023614203940	29.99
1" BAR ST/LT Recoil Pad	11452	023614203957	29.99

**PAD** - Black, polymer cushion  
**TOP INSERT** - Hard polypropylene  
**REINFORCEMENT** - Black, glass-fiber reinforced synthetic  
**THICKNESS** - Choice of ½", ¾" or 1"

**BAR EXTRA MAGAZINES**

CALIBER	CODE NUMBER	UPC #	SUGG. RETAIL
<b>EXTRA MAGAZINES, BAR MARK II, SAFARI AND LIGHTWEIGHT STALKER</b>			
243 Win. and 308 Win.	112025011	023614975991	\$69.99
270 WSM	112025041	023614182498	69.99
7mm WSM	112025042	023614182504	69.99
300 WSM	112025030	023614180203	69.99
<b>EXTRA MAGAZINES, BAR LONGTRAC, BAR MARK II, SAFARI AND LIGHTWEIGHT STALKER</b>			
270 Win., 25-06 Rem., 30-06 Sprg.	112025024	023614975984	\$69.99
300 Win. Mag.	112025029	023614976004	69.99
338 Win. Mag.	112025031	023614976011	69.99
7mm Rem. Mag.	112025027	023614629528	69.99
<b>EXTRA MAGAZINES, BAR SHORTTRAC</b>			
243 Win. and 308 Win.	112025050	023614199526	\$69.99
7mm-08 Rem.	112025051	023614061694	69.99
270 WSM	112025055	023614199533	69.99
7mm WSM	112025055	023614199533	69.99
300 WSM	112025055	023614199533	69.99
325 WSM	112025052	023614061700	69.99

**THE BROWNING BAR. THE AUTOLOADER YOU DEMAND.**

With more than ten calibers and ten models to choose from, there is a flat-shooting Browning BAR autoloader built for you. From elegant guns with a satin nickel receiver finish to rugged models with composite stocks that are fully camouflaged for better concealment, all share the same reputation for accuracy and durability that has made the BAR a favorite for decades.

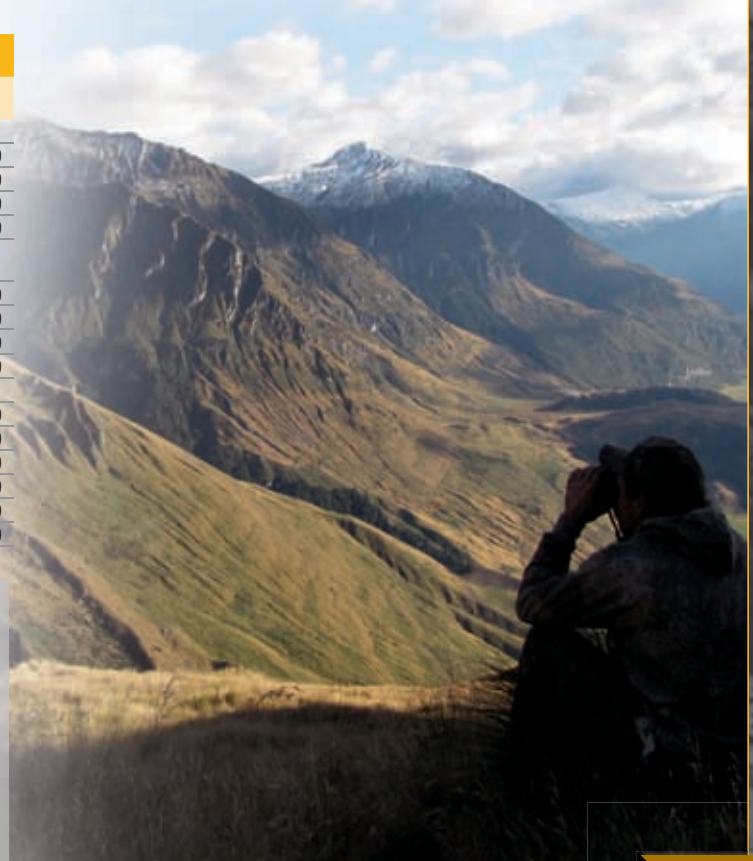



**BAR LIGHTWEIGHT STALKER** ▶ NON-GLARE COMPOSITE FINISH STOCK AND FOREARM



**RECEIVER** - Aircraft-grade alloy  
 · Matte blued finish · Drilled and tapped for scope mounts  
**BARREL** - Matte blued finish  
 · Hammer-forged · Adjustable open sights

**ACTION** - Gas-operated autoloader  
 · Multi-lug rotary bolt · Detachable box magazine · Crossbolt safety  
**STOCK** - Composite · Matte black finish · Checkered  
**FEATURES** - Sling swivel studs installed · Recoil pad

**BAR MK II SAFARI** ▶ GLOSS FINISH STOCK AND FOREARM



**RECEIVER** - Steel · Blued finish · Scroll engraving · Drilled and tapped for scope mounts  
**BARREL** - Blued finish · Hammer-forged  
**ACTION** - Gas-operated autoloader  
 · Multi-lug rotary bolt · Detachable box magazine · Crossbolt safety  
**STOCK** - Select gloss finish walnut  
 · Rounded forearm · Checkered  
**FEATURES** - Sling swivel studs installed  
 · Recoil pad · Available with BOSS® System, BOSS-CR optional  
 (Scope and mounts not included)

CALIBER	BARREL LENGTH	CODE NUMBER	UPC #	*TOTAL CAPACITY	**AVG. WEIGHT	OVERALL LENGTH	SIGHT RADIUS	***DROP AT COMB	DROP AT HEEL	LENGTH OF PULL	RATE OF TWIST	SUGG. RETAIL
<b>BAR LIGHTWEIGHT STALKER</b>												
243 Win.	20"	031008111	023614235620	5	6 lbs. 14 oz.	41"	16"	3/4"	1 1/8"	13 3/4"	1 in 10"	\$1,139.99
308 Win.	20"	031008118	023614235637	5	6 lbs. 14 oz.	41"	16"	3/4"	1 1/8"	13 3/4"	1 in 12"	1,139.99
270 WSM	23"	031008148	023614240198	3	7 lbs. 1 oz.	44"	18 1/2"	3/4"	1 1/8"	13 3/4"	1 in 10"	1,239.99
7mm WSM	23"	031008149	023614240211	3	7 lbs. 1 oz.	44"	18 1/2"	3/4"	1 1/8"	13 3/4"	1 in 9 1/2"	1,239.99
300 WSM	23"	031008146	023614238287	3	7 lbs. 1 oz.	44"	18 1/2"	3/4"	1 1/8"	13 3/4"	1 in 10"	1,239.99
270 Win.	22"	031008124	023614235644	5	7 lbs.	43"	17 1/2"	3/4"	1 1/8"	13 3/4"	1 in 10"	1,139.99
30-06 Sprg.	22"	031008126	023614235651	5	7 lbs.	43"	17 1/2"	3/4"	1 1/8"	13 3/4"	1 in 10"	1,139.99
300 Win. Mag.	24"	031008129	023614235675	4	7 lbs. 2 oz.	45"	19 1/2"	3/4"	1 1/8"	13 3/4"	1 in 10"	1,239.99
338 Win. Mag.	24"	031008131	023614235682	4	7 lbs. 2 oz.	45"	19 1/2"	3/4"	1 1/8"	13 3/4"	1 in 10"	1,239.99
<b>BAR MK II SAFARI</b>												
243 Win.	22"	031001211	023614286967	5	7 lbs. 8 oz.	43"	—	3/4"	1 1/8"	13 3/4"	1 in 10"	\$1,149.99
308 Win.	22"	031001218	023614287001	5	7 lbs. 8 oz.	43"	—	3/4"	1 1/8"	13 3/4"	1 in 12"	1,149.99
25-06 Rem.	24"	031001223	023614074939	5	7 lbs. 10 oz.	45"	—	3/4"	1 1/8"	13 3/4"	1 in 10"	1,149.99
270 Win.	22"	031001224	023614286974	5	7 lbs. 8 oz.	43"	—	3/4"	1 1/8"	13 3/4"	1 in 10"	1,149.99
30-06 Sprg.	22"	031001226	023614286998	5	7 lbs. 8 oz.	43"	—	3/4"	1 1/8"	13 3/4"	1 in 10"	1,149.99
7mm Rem. Mag.	24"	031001227	023614287018	4	8 lbs. 10 oz.	45"	—	3/4"	1 1/8"	13 3/4"	1 in 9 1/2"	1,269.99
300 Win. Mag.	24"	031001229	023614287025	4	8 lbs. 10 oz.	45"	—	3/4"	1 1/8"	13 3/4"	1 in 10"	1,269.99
338 Win. Mag.	24"	031001231	023614287032	4	8 lbs. 10 oz.	45"	—	3/4"	1 1/8"	13 3/4"	1 in 10"	1,269.99
<b>BAR MK II SAFARI WITH BOSS (SHOWN)</b>												
270 WSM	23"	031001348	023614240174	3	8 lbs. 4 oz.	44"	—	3/4"	1 1/8"	13 3/4"	1 in 10"	\$1,399.99
7mm WSM	23"	031001349	023614240181	3	8 lbs. 4 oz.	44"	—	3/4"	1 1/8"	13 3/4"	1 in 9 1/2"	1,399.99
300 WSM	23"	031001346	023614239307	3	8 lbs. 4 oz.	44"	—	3/4"	1 1/8"	13 3/4"	1 in 10"	1,399.99
270 Win.	22"	031001324	023614631699	5	7 lbs. 6 oz.	43"	—	3/4"	1 1/8"	13 3/4"	1 in 10"	1,299.99
30-06 Sprg.	22"	031001326	023614631712	5	7 lbs. 6 oz.	43"	—	3/4"	1 1/8"	13 3/4"	1 in 10"	1,299.99
7mm Rem. Mag.	24"	031001327	023614631736	4	8 lbs. 6 oz.	45"	—	3/4"	1 1/8"	13 3/4"	1 in 9 1/2"	1,399.99
300 Win. Mag.	24"	031001329	023614631743	4	8 lbs. 6 oz.	45"	—	3/4"	1 1/8"	13 3/4"	1 in 10"	1,399.99
338 Win. Mag.	24"	031001331	023614631750	4	8 lbs. 6 oz.	45"	—	3/4"	1 1/8"	13 3/4"	1 in 10"	1,399.99

NOTE: \*Total capacity includes one round in the chamber. \*\*Weights listed are approximate. \*\*\*Measured from centerline of bore.



# T-BOLT

**TOP RIMFIRE PERFORMANCE.** The T-Bolt is a one-of-a-kind rifle that is elegant and fun to shoot. Built to the highest standards of quality, these flat-shooting rimfires feature a slick straight-pull bolt that cycles fast and locks-up snug to the barrel for unmatched accuracy. Experience a higher level of rimfire performance with each squeeze of the trigger from the Browning T-Bolt.

## STOCK

Available in both right- and left-hand models, T-Bolt rifle stocks are full-size to comfortably fit adults. Durable Composite models feature a Monte Carlo comb and include magazine storage in the buttstock. Walnut stocked Sporter models feature trim dimensions with a satin finish and cut checkering. Walnut Target/Varmint models feature a Monte Carlo comb and wide forearm for stability on the bench. All models include dual action screws for solid attachment, sling swivel studs and a synthetic buttplate.



## TRIGGER

The three-lever trigger design combined with a short-travel firing pin give a crisp break, quick lock time, no take-up and minimal overtravel. It is also externally adjustable for pull weight.

## ACTION

Receiver is machined from steel barstock. Features crossbolt lockup and an enlarged bolt handle pivot point moved forward for smoother action. The mainspring runs directly through the massive pivot pin. Cocking effort is split between opening and closing for ease of operation. The bolt features dual extractors and a red cocking indicator band. Right-side ejection on both right- and left-hand models.



## SAFETY

Top-tang, thumb operated two-position safety can be operated without changing from a shooting grip.

## BARREL

Target/Varmint models feature a 22" heavy varmint profile. T-Bolt Sporter models feature a 22" medium sporter profile. All are free-floating and have a semi-match chamber and target muzzle crown.

## SIGHTS

Receiver is drilled and tapped for scope mounts (scope not included). See page 136 for scope rings and bases for T-Bolt rifles.

*All Browning firearms are shipped with a free locking device to assist in the safe storage of firearms.*





.22 Long Rifle  
17 HMR/  
22 WMR



**MAGAZINE**

Patent pending Double Helix® rotary box magazine. Torsion spring driven interlocking gears on the Double Helix magazine provide added reliability plus easy loading and unloading. 10-round capacity.

CALIBER	CODE NUMBER	UPC #	SUGG. RETAIL
22 L.R.	112055290	023614203964	\$49.99
17 HMR/22 WMR	112055291	023614048091	49.99

**T-BOLT COMPOSITE SPORTER ▶ NON-GLARE COMPOSITE FINISH STOCK**



**RECEIVER** - Steel · Blued finish  
· Drilled and tapped for scope mounts  
**BARREL** - Medium sporter · Blued finish  
· Free-floating · Semi-match chamber  
· Recessed crown  
**ACTION** - Straight pull bolt-action · Top-tang safety · Adjustable trigger · Right- and left-hand models have right side ejection

**STOCK** - Composite · Textured gripping surfaces · Matte black  
· Spare magazine storage compartment  
**FEATURES** - Sling swivel studs installed  
(Scope and mounts not included)



Buttstock Magazine Storage

CALIBER	BARREL LENGTH	CODE NUMBER	UPC #	*TOTAL CAPACITY	**AVG. WEIGHT	OVERALL LENGTH	SIGHT RADIUS	***DROP AT COMB	DROP AT HEEL	LENGTH OF PULL	RATE OF TWIST	SUGG. RETAIL
<b>T-BOLT COMPOSITE SPORTER (SHOWN)</b>												
22 L.R.	22"	025179202	023614257905	11	4 lbs. 9 oz.	40¼"	—	⅝"	⅝"	13½"	1 in 16"	\$699.99
22 WMR	22"	025179204	023614257912	11	4 lbs. 9 oz.	40¼"	—	⅝"	⅝"	13½"	1 in 16"	749.99
17 HMR	22"	025179270	023614257929	11	4 lbs. 9 oz.	40¼"	—	⅝"	⅝"	13½"	1 in 9"	749.99
<b>T-BOLT COMPOSITE SPORTER, LEFT-HAND</b>												
22 L.R.	22"	025186202	023614065562	11	4 lbs. 9 oz.	40¼"	—	⅝"	⅝"	13½"	1 in 16"	\$719.99
22 WMR	22"	025186204	023614065579	11	4 lbs. 9 oz.	40¼"	—	⅝"	⅝"	13½"	1 in 16"	759.99
17 HMR	22"	025186270	023614065586	11	4 lbs. 9 oz.	40¼"	—	⅝"	⅝"	13½"	1 in 9"	759.99
<b>T-BOLT COMPOSITE TARGET/VARMINT (SHOWN)</b>												
22 L.R.	22"	025180202	023614258926	11	5 lbs. 2 oz.	40¼"	—	⅝"	⅝"	13½"	1 in 16"	\$749.99
22 WMR	22"	025180204	023614258933	11	5 lbs. 2 oz.	40¼"	—	⅝"	⅝"	13½"	1 in 16"	779.99
17 HMR	22"	025180270	023614258940	11	5 lbs. 2 oz.	40¼"	—	⅝"	⅝"	13½"	1 in 9"	779.99
<b>T-BOLT COMPOSITE TARGET/VARMINT, LEFT-HAND</b>												
22 L.R.	22"	025187202	023614065593	11	5 lbs. 2 oz.	40¼"	—	⅝"	⅝"	13½"	1 in 16"	\$759.99
22 WMR	22"	025187204	023614065609	11	5 lbs. 2 oz.	40¼"	—	⅝"	⅝"	13½"	1 in 16"	789.99
17 HMR	22"	025187270	023614065616	11	5 lbs. 2 oz.	40¼"	—	⅝"	⅝"	13½"	1 in 9"	789.99
<b>T-BOLT SPORTER</b>												
22 L.R.	22"	025175202	023614252733	11	4 lbs. 14 oz.	40¼"	—	⅝"	⅝"	13½"	1 in 16"	\$699.99
22 WMR	22"	025175204	023614257936	11	4 lbs. 14 oz.	40¼"	—	⅝"	⅝"	13½"	1 in 16"	749.99
17 HMR	22"	025175270	023614257943	11	4 lbs. 14 oz.	40¼"	—	⅝"	⅝"	13½"	1 in 9"	749.99
<b>T-BOLT SPORTER, LEFT-HAND</b>												
22 L.R.	22"	025184202	023614065500	11	4 lbs. 14 oz.	40¼"	—	⅝"	⅝"	13½"	1 in 16"	\$719.99
22 WMR	22"	025184204	023614065517	11	4 lbs. 14 oz.	40¼"	—	⅝"	⅝"	13½"	1 in 16"	759.99
17 HMR	22"	025184270	023614065524	11	4 lbs. 14 oz.	40¼"	—	⅝"	⅝"	13½"	1 in 9"	759.99
<b>T-BOLT TARGET/VARMINT (SHOWN)</b>												
22 L.R.	22"	025176202	023614255222	11	5 lbs. 8 oz.	40¼"	—	⅝"	⅝"	13½"	1 in 16"	\$749.99
22 WMR	22"	025176204	023614257950	11	5 lbs. 8 oz.	40¼"	—	⅝"	⅝"	13½"	1 in 16"	779.99
17 HMR	22"	025176270	023614257967	11	5 lbs. 8 oz.	40¼"	—	⅝"	⅝"	13½"	1 in 9"	779.99
<b>T-BOLT TARGET/VARMINT, LEFT-HAND</b>												
22 L.R.	22"	025185202	023614065531	11	5 lbs. 8 oz.	40¼"	—	⅝"	⅝"	13½"	1 in 16"	\$759.99
22 WMR	22"	025185204	023614065548	11	5 lbs. 8 oz.	40¼"	—	⅝"	⅝"	13½"	1 in 16"	789.99
17 HMR	22"	025185270	023614065555	11	5 lbs. 8 oz.	40¼"	—	⅝"	⅝"	13½"	1 in 9"	789.99

NOTE: \*Total capacity includes one round in the chamber. \*\*Weights listed are approximate. \*\*\*Measured from centerline of bore.



**T-BOLT COMPOSITE TARGET/VARMINT** ▶ NON-GLARE COMPOSITE FINISH STOCK



- RECEIVER** - Steel · Blued finish
  - Drilled and tapped for scope mounts
- BARREL** - Medium target · Blued finish
  - Free-floating · Semi-match chamber
  - Recessed crown
- ACTION** - Straight pull bolt-action
  - Top-tang safety · Adjustable trigger
  - Right- and left-hand models have right side ejection
- STOCK** - Composite · Textured gripping surfaces · Matte black · Spare magazine storage compartment
- FEATURES** - Sling swivel studs installed (Scope and mounts not included)

**T-BOLT SPORTER** ▶ SATIN FINISH STOCK

*T-Bolt Sporter, Right-Hand*



*T-Bolt Sporter, Left-Hand*

- RECEIVER** - Steel · Blued finish
  - Drilled and tapped for scope mounts
- BARREL** - Medium sporter · Blued finish
  - Free-floating · Semi-match chamber
  - Recessed crown

- ACTION** - Straight pull bolt-action
  - Top-tang safety · Adjustable trigger
  - Right- and left-hand models have right side ejection
- STOCK** - Satin finish walnut · Checkered
- FEATURES** - Sling swivel studs installed



**T-BOLT TARGET/VARMINT** ▶ SATIN FINISH STOCK



- RECEIVER** - Steel · Blued finish · Drilled and tapped for scope mounts
- BARREL** - Medium target · Blued finish
  - Free-floating · Semi-match chamber
  - Recessed crown
- ACTION** - Straight pull bolt-action · Top-tang safety · Adjustable trigger · Right- and left-hand models have right side ejection

- STOCK** - Satin finish walnut
  - Monte Carlo comb
  - Wide fore-end · Checkered
- FEATURES** - Sling swivel studs installed (Scope and mounts not included)



# BL-22

**LEVER-ACTION FUN.** Well-made, accurate and quick handling, a Browning BL-22 is sure to be among your favorite rifles.

**BL-22 GRADE I MICRO MIDAS ▶ GLOSS FINISH STOCK AND FOREARM**

**NEW**



**RECEIVER** - Steel · Blued finish  
 · Grooved for scope mounts  
**BARREL** - Blued finish · Recessed crown  
**ACTION** - Lever-action · Short 33° throw  
 · Tubular magazine

**STOCK** - Gloss finish American walnut · Straight grip · Compact 12" length of pull for smaller shooters  
**FEATURES** - Adjustable sights

**BL-22 FULL LINE DEALER, GRADE II OCTAGON ▶ SATIN FINISH STOCK AND FOREARM**

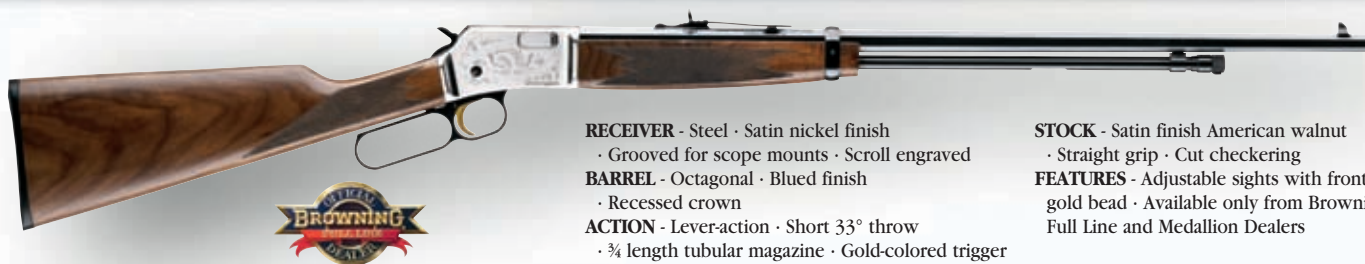

**RECEIVER** - Steel · Satin nickel finish  
 · Grooved for scope mounts · Scroll engraved  
**BARREL** - Octagonal · Blued finish  
 · Recessed crown  
**ACTION** - Lever-action · Short 33° throw  
 · ¾ length tubular magazine · Gold-colored trigger

**STOCK** - Satin finish American walnut  
 · Straight grip · Cut checkering  
**FEATURES** - Adjustable sights with front gold bead · Available only from Browning Full Line and Medallion Dealers

**BL-22 FULL LINE DEALER, GRADE I AND II ▶ SATIN FINISH STOCK AND FOREARM**



**RECEIVER** - Steel · Satin nickel finish · Grooved for scope mounts · Grade II is scroll engraved  
**BARREL** - Blued finish · Recessed crown  
**ACTION** - Lever-action · Short 33° throw · Tubular magazine · Grade II has gold-colored trigger

**STOCK** - Satin finish American walnut  
 · Straight grip · Grade II has cut checkering  
**FEATURES** - Adjustable sights with front bead · Available only from Browning Full Line and Medallion Dealers

**BL-22 GRADE I AND II ▶ GLOSS FINISH STOCK AND FOREARM**



**RECEIVER** - Steel · Blued finish · Grooved for scope mounts · Grade II is scroll engraved  
**BARREL** - Blued finish · Recessed crown  
**ACTION** - Lever-action · Short 33° throw · Tubular magazine · Grade II has gold-colored trigger

**STOCK** - Gloss finish American walnut · Straight grip · Grade II has cut checkering  
**FEATURES** - Adjustable sights

	CALIBER	BARREL LENGTH	CODE NUMBER	UPC #	*TOTAL CAPACITY	**AVG. WEIGHT	OVERALL LENGTH	SIGHT RADIUS	***DROP AT COMB	DROP AT HEEL	LENGTH OF PULL	RATE OF TWIST	SUGG. RETAIL
<b>BL-22 GRADE I MICRO MIDAS</b>													
<b>NEW</b>	22 L.R.	19¾"	024115103	023614071242	12	4 lbs. 12 oz.	31½"	11½"	⅞"	1½"	12"	1 in 16"	\$479.99
<b>BL-22 FULL LINE DEALER, GRADE II OCTAGON</b>													
	22 S, L & L.R.	24"	024105155	023614243816	15 L.R.	5 lbs. 4 oz.	40¾"	19¾"	⅞"	1½"	13½"	1 in 16"	\$919.99
<b>BL-22 FULL LINE DEALER, GRADE I AND II</b>													
	Grade I	22 S, L & L.R.	20"	024107102	023614250197	15 L.R.	5 lbs.	36¾"	15¾"	⅞"	1½"	13½"	\$619.99
(Shown)	Grade II	22 S, L & L.R.	20"	024108102	023614250203	15 L.R.	5 lbs.	36¾"	15¾"	⅞"	1½"	13½"	699.99
<b>BL-22 GRADE I AND II</b>													
	Grade I	22 S, L & L.R.	20"	024100103	023614025474	15 L.R.	5 lbs.	36¾"	15¾"	⅞"	1½"	13½"	\$579.99
(Shown)	Grade II	22 S, L & L.R.	20"	024101103	023614025481	15 L.R.	5 lbs.	36¾"	15¾"	⅞"	1½"	13½"	669.99

NOTE: \*Total capacity includes one round in the chamber. \*\*Weights listed are approximate. \*\*\*Measured from centerline of bore.



## SA-22

**ACTION**

Takedown autoloader with bottom ejection.

**RECEIVER**

Grade I is engraved with scroll design and a polished, blued finish. Grade VI models are available in polished blued or satin grayed finish.

**ENGRAVING**

Grade VI models are deeply engraved with game scenes. Game figures are 24 karat gold-plated.

**SIGHTS**

Gold bead front and adjustable, folding leaf rear.

**TRIGGER**

Blued on Grade I. Gold on Grade VI.

**BARREL**

Drilled and tapped to accept a scope mount.

**SAFETY**

Manual trigger-blocking safety is mounted on the trigger guard.

**MAGAZINE**

Tubular. Capacity: 11 Long Rifle cartridges.

**STOCK AND FOREARM**

Select American walnut is checkered with a polished gloss finish.

**A TRIBUTE TO THE GENIUS OF JOHN M. BROWNING.**

Experience the ingenuity of John M. Browning firsthand with a classic SA-22. These timeless autoloaders are direct from the genius of the most famous gun maker that has ever lived. Natural to the shoulder and quick to point, the SA-22 is a legend in steel and wood.

*All Browning firearms are shipped with a free locking device to assist in the safe storage of firearms.*

**SEMI-AUTO 22 GRADE I** ▶ GLOSS FINISH STOCK AND FOREARM

**RECEIVER** - Steel · Takedown design  
· Polished blued finish · Scroll engraving  
**BARREL** - Polished blued finish · Drilled and tapped for scope mounts

**ACTION** - Autoloading · Bottom ejection  
· Tubular magazine · Crossbolt safety  
**STOCK** - Gloss finish select American walnut · Checkered  
**FEATURES** - Adjustable sights with gold bead front sight blade

**SEMI-AUTO 22 GRADE VI** ▶ GLOSS FINISH STOCK AND FOREARM

**RECEIVER** - Steel · Takedown design  
· Polished blued or satin grayed finish  
· Game scene engraving with 24 karat gold accents

**BARREL** - Polished blued finish  
· Drilled and tapped for scope mounts  
**ACTION** - Autoloading · Bottom ejection  
· Tubular magazine · Crossbolt safety  
**STOCK** - Gloss finish select American walnut · Checkered  
**FEATURES** - Adjustable sights with gold bead front sight blade



*The grayed receiver of the Semi-Auto 22 Grade VI is adorned with gold animal scenes.*



*The Semi-Auto 22 can be quickly taken down to a compact length of only 19 3/8" for storage or packing.*

	CALIBER	BARREL LENGTH	CODE NUMBER	UPC #	*TOTAL CAPACITY	**AVG. WEIGHT	OVERALL LENGTH	SIGHT RADIUS	***DROP AT COMB	DROP AT HEEL	LENGTH OF PULL	RATE OF TWIST	SUGG. RETAIL
<b>SEMI-AUTO 22 GRADE I</b>													
	22 L.R.	19 3/8"	021001102	023614025559	11	5 lbs. 3 oz.	37"	16 1/4"	1 3/16"	2 3/8"	13 3/4"	1 in 16"	\$669.99
<b>SEMI-AUTO 22 GRADE VI</b>													
	Blued	22 L.R.	021002102	023614824831	11	5 lbs. 3 oz.	37"	16 1/4"	1 3/16"	2 3/8"	13 3/4"	1 in 16"	\$1,499.99
	Grayed	22 L.R.	021003102	023614824848	11	5 lbs. 3 oz.	37"	16 1/4"	1 3/16"	2 3/8"	13 3/4"	1 in 16"	1,499.99

NOTE: \*Total capacity includes one round in the chamber. \*\*Weights listed are approximate. \*\*\*Measured from centerline of bore.



# BUCK MARK RIFLE



**SIGHTS** The Sporter model features a TRUGLO®/Marble's® fiber-optic sight system.

**BARREL** Sporter model features lightweight, tapered sporter-weight barrel. Target models feature a steel bull barrel. The chamber in every Buck Mark Rifle barrel is hand-reamed and the muzzle crown is recessed to protect it from damage that could degrade accuracy.



**SAFETY**

Large manual thumb safety.

**MAGAZINE RELEASE**

Positioned adjacent to the trigger guard for convenient operation.



**ACTION**

The straight blowback design offers enhanced simplicity and reliability.

**FRAME**

Machined to exacting tolerances from a solid billet of 7075-T6 aluminum. The stock structure is a part of the pistol frame, reducing weight and the number of parts.

**SLIDE**

Built-in recess and raised side panels for an improved cocking grip. The convenient manual slide release is easily operated with the shooting or support hand.



**MAGAZINE**

Magazines are interchangeable with the Buck Mark pistol. The magazine body is heat-treated for long-term feeding reliability and long life. Our coil spring provides a consistent follower angle. 10-round capacity.

**TRIGGER**

The trigger is light, crisp and has less creep before it breaks and far less overtravel after breaking than other rimfires.

*All Browning firearms are shipped with a free locking device to assist in the safe storage of firearms.*

**Made  
in the USA**







**COMPACT RIMFIRE FUN.**

The Buck Mark Rifle is Made in the USA and always ready for an afternoon hunting squirrels, rabbits or X-rings. These handy rifles are lightweight, easy to shoot and always reliable. They look neat, too. The proven coil spring magazine feeds ten cartridges and makes reloading a cinch. Get your hands on a Buck Mark rifle today.

**BUCK MARK FULL LINE DEALER TARGET GRAY LAMINATE RIFLE ▶ SATIN FINISH STOCK AND FOREARM**



**RECEIVER** - Alloy · Matte blued finish  
**BARREL** - Heavy bull · Matte blued finish · Target crown  
**ACTION** - Blowback · Single-action trigger · Detachable magazine

**STOCK** - Laminated gray satin finish hardwood  
**FEATURES** - Integral scope rail · Available only from Browning Full Line and Medallion Dealers

**BUCK MARK TARGET RIFLE ▶ OIL FINISH STOCK AND FOREARM**



**RECEIVER** - Alloy · Matte blued finish  
**BARREL** - Heavy bull · Matte blued finish · Target crown  
**ACTION** - Blowback · Single-action trigger · Detachable magazine

**STOCK** - Oil finish walnut  
**FEATURES** - Integral scope rail (Reflex sight not included)

**BUCK MARK SPORTER RIFLE ▶ OIL FINISH STOCK AND FOREARM**



**RECEIVER** - Alloy · Matte blued finish  
**BARREL** - Tapered sporter · Matte blued finish · Target crown  
**ACTION** - Blowback · Single-action trigger · Detachable magazine

**STOCK** - Oil finish walnut  
**FEATURES** - TRUGLO®/Marble's® adjustable fiber-optic sights · Integral scope rail

CALIBER	BARREL LENGTH	CODE NUMBER	UPC #	*TOTAL CAPACITY	**AVG. WEIGHT	OVERALL LENGTH	SIGHT RADIUS	***DROP AT COMB	DROP AT HEEL	LENGTH OF PULL	RATE OF TWIST	SUGG. RETAIL
<b>BUCK MARK FULL LINE DEALER TARGET GRAY LAMINATE RIFLE</b>												
22 L.R.	18"	021030202	023614239000	11	5 lbs. 8 oz.	33 <sup>3</sup> / <sub>8</sub> "	—	7/8"	1 <sup>1</sup> / <sub>2</sub> "	15 <sup>1</sup> / <sub>8</sub> "	1 in 16"	\$679.99
<b>BUCK MARK TARGET RIFLE</b>												
22 L.R.	18"	021025202	023614235491	11	5 lbs. 6 oz.	33 <sup>3</sup> / <sub>8</sub> "	—	7/8"	1 <sup>1</sup> / <sub>2</sub> "	15 <sup>1</sup> / <sub>8</sub> "	1 in 16"	\$659.99
<b>BUCK MARK SPORTER RIFLE</b>												
22 L.R.	18"	021026102	023614235507	11	4 lbs. 6 oz.	33 <sup>3</sup> / <sub>8</sub> "	12 <sup>3</sup> / <sub>8</sub> "	7/8"	1 <sup>1</sup> / <sub>2</sub> "	15 <sup>1</sup> / <sub>8</sub> "	1 in 16"	\$659.99

NOTE: \*Total capacity includes one round in the chamber. \*\*Weights listed are approximate. \*\*\*Measured from centerline of bore.





# 1911 & 22



## AFTER 100 YEARS, YOUR WAIT IS FINALLY OVER.

In celebration of the 100th anniversary of the classic 1911, Browning is pleased to introduce a scaled-down, 22 L.R. version of this great firearm. The new Browning 1911-22 is proudly made in the USA and will include a special first year of production collector's certificate plus a free limited edition commemorative canvas and leather zippered pistol case (a \$49.99 retail value) with 1911-22 pistols shipped during 2011.



### 1911-2011 COMMEMORATIVE LIMITED EDITION ZIPPERED PISTOL RUG – INCLUDED FREE!

It's durably constructed with a supple waxed cotton canvas shell, top-grain leather trim, plush green flannel lining and a nylon coil zipper, along with John M. Browning's signature and a special 1911-2011 logo adorning the outside. A solid brass hanging ring and a keyed brass padlock are included. This special commemorative pistol rug is a \$49.99 retail value and will only be available with the purchase of the new Browning 1911-22 made during 2011.



### COLLECTOR'S CERTIFICATE

Each pistol made during the first year of production will include a beautiful collector's certificate of authenticity that commemorates the 100th anniversary of the US Military's adoption of the Browning 1911, the world's most legendary autoloading pistol.

All Browning firearms are shipped with a free locking device to assist in the safe storage of firearms.



1911-22 PISTOL

**NEW**

You will find a familiar friend in the 1911-22 pistol. All controls operate just as those on the original John M. Browning-designed Model 1911.

*Made in the USA*

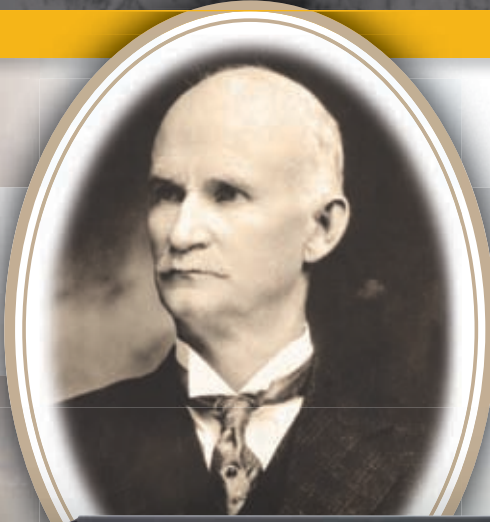

Right side view

- FRAME** - Alloy · Matte blued finish
- SLIDE** - Machined aluminum · Matte blued finish
- BARREL** - Stainless steel barrel block · Matte blued finish · Target crown
- ACTION** - Blowback · Single-action trigger
- GRIPS** - Brown composite
- FEATURES** - Fixed sights · Detachable 10-round magazine · Manual thumb safety · Grip safety

1911-22 EXTRA MAGAZINES

**NEW**

CALIBER	CODE #	UPC #	SUGG. RETAIL
<b>NEW</b> 22 L.R.	112055191	023614370123	\$29.99

Left side view



**ACTION**

The straight blowback design offers enhanced simplicity and reliability.

**FRAME**

Machined to exacting tolerances from aluminum.

**SLIDE**

Vertical serrations provide an improved cocking grip. The convenient manual slide release is easily operated with the shooting or support hand.

**SAFETY**

Large manual thumb safety and grip safety.

**MAGAZINE**

The steel magazine body is heat treated for long-term feeding reliability and long life. Our coil spring provides a consistent follower angle. 10-round capacity.

**MAGAZINE RELEASE**

Positioned adjacent to the trigger guard for convenient operation.

*Pistol Rug Included in 2011*

MODEL	CALIBER	FINISH	GRIPS	BARREL LENGTH	CODE NUMBER	UPC #	*AVG. WEIGHT	OVERALL LENGTH	SIGHT RADIUS	SUGG. RETAIL
<b>NEW</b> A1 (shown)	22 L.R.	Matte Black	Brown Composite	4¼"	051802490	023614072003	15½ oz.	7⅞"	5½"	\$599.99
<b>NEW</b> Compact	22 L.R.	Matte Black	Brown Composite	3¾"	051803490	023614072010	15 oz.	6½"	4⅞"	599.99



**ACTION**

The straight blowback design offers enhanced simplicity and reliability.

**SLIDE**

Built-in recess and raised side panels for improved cocking grip. The convenient manual slide release is easily operated with your shooting or support hand.

**BARREL**

Most models have bull barrels for improved stability. Lite models have a steel barrel liner inside an ultralight aluminum sleeve. The chamber is hand-reamed and the muzzle crown is recessed to protect it from damage that could degrade accuracy.

**REAR SIGHT**

16-click per revolution adjustable Pro-Target™ sight is standard on all models. This sight provides a finer range of adjustment over the industry's standard of 12-clicks per revolution.

**FRONT SIGHT**

Plus models feature a TRUGLO®/Marble's® fiber-optic front sight. The 5.5 Target models include hooded target sights.

**FRAME**

While many popular 22 pistols are cast or fabricated from sheet metal stampings, each Buck Mark frame is CNC machined from 7075-T6 aluminum to exacting tolerances.

**MAGAZINE**

The magazine body is heat treated for long-term feeding reliability. Coil spring provides more consistent follower angle. 10-round capacity.

**MAGAZINE RELEASE**

Positioned adjacent to the trigger guard for convenient operation.

**TRIGGER**

Compare it to the competition and feel its light, crisp break with less creep and overtravel.

**SAFETY**

Large, manual thumb safety. The trigger is disconnected when the magazine is removed for added safety.

**GRIPS**

Several wood, laminate and composite styles are available. Soft nitrile rubber Ultragrip RX® (URX) and wood Ultragrip Deluxe® (UDX) ambidextrous grips have ergonomic finger grooves for enhanced control.

**MADE IN THE USA TO A HIGHER STANDARD OF QUALITY.**

Precision, accuracy, reliability and pure enjoyment are all features you get in the Browning Buck Mark. These affordable pistols are Made in the USA and offer plenty of bang for your buck with a machined aluminum frame, precision rifled barrel, smooth trigger and fully-adjustable sights.

# BUCK MARK PISTOL



Made in the USA



*The straight blowback design and hand-reamed chamber of the Buck Mark contribute to its legendary reliability and accuracy.*



*Ultragrip RX® adds control and comfort.*



*Pro-Target rear sight offers finer adjustment clicks for greater accuracy.*

EXTRA MAGAZINES				
CALIBER	CODE NUMBER	UPC #	WHOLESALE	SUGG. RETAIL
22 L.R.	112055190	023614025290	\$17.25	\$29.99

*All Browning firearms are shipped with a free locking device to assist in the safe storage of firearms.*



**BUCK MARK LITE GREEN/GRAY**



**RECEIVER** - Alloy · Matte green or gray finish  
**BARREL** - Alloy sleeved · Matte green or gray finish  
 · Fluted · Available in 5½" length  
**ACTION** - Blowback · Single-action trigger  
**GRIPS** - Ultragrip RX® ambidextrous  
**FEATURES** - Pro-Target™ adjustable rear sight  
 · TRUGLO®/Marble's® fiber-optic front sight

**BUCK MARK PRACTICAL URX**



**RECEIVER** - Alloy · Matte gray finish  
**BARREL** - Tapered bull 5½" · Matte blued finish  
**ACTION** - Blowback · Single-action trigger  
**GRIPS** - Ultragrip RX® ambidextrous  
**FEATURES** - Pro-Target™ adjustable rear sight  
 · TRUGLO®/Marble's® fiber-optic front sight

**BUCK MARK PLUS UDX**



**RECEIVER** - Alloy · Matte blued finish  
 · Finger grooves  
**BARREL** - Slabside · Matte blued finish  
 · 5½" length  
**ACTION** - Blowback · Single-action trigger  
**GRIPS** - Walnut Ultragrip DX® ambidextrous  
**FEATURES** - Pro-Target™ adjustable rear sight  
 · TRUGLO®/Marble's® fiber-optic front sight

MODEL	FINISH	GRIPS	BARREL LENGTH	CODE NUMBER	UPC #	*AVG. WEIGHT	OVERALL LENGTH	SIGHT RADIUS	SUGG. RETAIL
Lite Green 5.5	Matte Green	URX Ambidextrous	5½"	051459490	023614068181	28 oz.	9½"	8"	\$549.99
Lite Gray 5.5 (shown)	Matte Gray	URX Ambidextrous	5½"	051461490	023614068204	28 oz.	9½"	8"	549.99
Practical URX	Matte Gray	URX Ambidextrous	5½"	051448490	023614259541	34 oz.	9½"	8"	419.99
Plus UDX	Matte Blued	Brown Laminate UDX, Ambidextrous	5½"	051428490	023614251897	34 oz.	9½"	8"	509.99

NOTE: \*Weights listed are approximate.



**BUCK MARK PLUS STAINLESS UDX**



RECEIVER - Alloy · Matte blued finish · Finger grooves  
 BARREL - Stainless slabside · Matte finish · 5½" length  
 ACTION - Blowback · Single-action trigger  
 GRIPS - Black laminated Ultragrip DX® ambidextrous  
 FEATURES - Pro-Target™ adjustable rear sight  
 · TRUGLO®/Marble's® fiber-optic front sight

**BUCK MARK PLUS ROSEWOOD UDX, FLD**



RECEIVER - Alloy · Matte blued finish · Finger grooves  
 BARREL - Slabside · Matte blued finish · 5½" length  
 ACTION - Blowback · Single-action trigger  
 GRIPS - Rosewood Ultragrip DX® ambidextrous  
 FEATURES - Pro-Target™ adjustable rear sight  
 · TRUGLO®/Marble's® fiber-optic front sight  
 · Available only from Browning Full Line and Medallion Dealers

**BUCK MARK CAMPER STAINLESS URX, FLD**



RECEIVER - Alloy · Matte blued finish  
 BARREL - Stainless tapered bull 5½" · Matte finish  
 ACTION - Blowback · Single-action trigger  
 GRIPS - Ultragrip RX® ambidextrous  
 FEATURES - Pro-Target™ adjustable rear sight  
 · TRUGLO®/Marble's® fiber-optic front sight  
 · Available only from Browning Full Line and Medallion Dealers

**BUCK MARK CAMPER**



RECEIVER - Alloy · Matte blued finish  
 BARREL - Tapered bull 5½" · Matte blued finish  
 ACTION - Blowback · Single-action trigger  
 GRIPS - Black composite  
 FEATURES - Pro-Target™ adjustable sights

**BUCK MARK CAMPER STAINLESS**



RECEIVER - Alloy · Matte blued finish  
 BARREL - Stainless tapered bull 5½" · Matte finish  
 ACTION - Blowback · Single-action trigger  
 GRIPS - Black composite  
 FEATURES - Pro-Target™ adjustable sights



MODEL	FINISH	GRIPS	BARREL LENGTH	CODE NUMBER	UPC #	*AVG. WEIGHT	OVERALL LENGTH	SIGHT RADIUS	SUGG. RETAIL
Plus Stainless UDX	Matte Stainless Slide & Barrel	Black Laminated UDX, Ambidextrous	5½"	051427490	023614253228	34 oz.	9½"	8"	\$549.99
Plus Rosewood UDX FLD	Matte Blued	Rosewood UDX, Ambidextrous	5½"	051429490	023614251903	34 oz.	9½"	8"	509.99
Camper Stainless URX FLD	Matte Stainless Slide & Barrel	Molded Comp., Ambidextrous	5½"	051442490	023614257349	34 oz.	9½"	8"	419.99
Camper	Matte Blued	Molded Comp., Ambidextrous	5½"	051379490	023614250302	34 oz.	9½"	8"	359.99
Camper Stainless	Matte Stainless Slide & Barrel	Molded Comp., Ambidextrous	5½"	051381490	023614250326	34 oz.	9½"	8"	399.99

NOTE: \*Weights listed are approximate.





**BUCK MARK STANDARD URX**



**RECEIVER** - Alloy · Matte blued finish  
**BARREL** - Slabside · Matte blued finish with polished flats · Available in Standard 5½" and Micro 4"  
**ACTION** - Blowback · Single-action trigger  
**GRIPS** - Ultragrip RX® ambidextrous  
**FEATURES** - Pro-Target™ adjustable sights

**BUCK MARK STANDARD STAINLESS URX**



**RECEIVER** - Alloy · Matte blued finish  
**BARREL** - Stainless slabside 5½"  
**ACTION** - Blowback · Single-action trigger  
**GRIPS** - Ultragrip RX® ambidextrous  
**FEATURES** - Pro-Target™ adjustable sights (Browning Reflex sight and optional scope base not included)

**BUCK MARK HUNTER**



*Includes Pistol Rug*

**RECEIVER** - Alloy · Matte blued finish  
**BARREL** - Heavy tapered round bull 7¼" · Matte blued finish · Integral scope base  
**ACTION** - Blowback · Single-action trigger  
**GRIPS** - Laminated cocobolo target  
**FEATURES** - Pro-Target™ adjustable rear sight · TRUGLO®/Marble's® fiber-optic front sight (Browning Reflex sight not included)

**BUCK MARK CONTOUR URX**



*Special barrel profile on Contour Model.*

*7.25 Includes Pistol Rug*

**RECEIVER** - Alloy · Matte blued finish  
**BARREL** - Special contour · Matte blued finish · Full-length scope base · Available in 5½" and 7¼"  
**ACTION** - Blowback · Single-action trigger  
**GRIPS** - Ultragrip RX® ambidextrous  
**FEATURES** - Pro-Target™ adjustable sights

MODEL	FINISH	GRIPS	BARREL LENGTH	CODE NUMBER	UPC #	*AVG. WEIGHT	OVERALL LENGTH	SIGHT RADIUS	SUGG. RETAIL
Standard URX (shown)	Matte Blued	URX Ambidextrous	5½"	051407490	023614250951	34 oz.	9½"	8"	\$439.99
Micro Standard URX	Matte Blued	URX Ambidextrous	4"	051408490	023614250968	32 oz.	8"	6¼"	439.99
Standard Stainless URX	Matte Stainless	URX Ambidextrous	5½"	051409490	023614250975	34 oz.	9½"	8"	479.99
Hunter	Matte Blued	Cocobolo, Ambidextrous	7¼"	051403490	023614250500	38 oz.	11½"	9½"	469.99
Contour 5.5 URX (shown)	Matte Blued, Polished Barrel Flats	URX Ambidextrous	5½"	051421490	023614251552	36 oz.	9½"	8"	519.99
Contour 7.25 URX	Matte Blued, Polished Barrel Flats	URX Ambidextrous	7¼"	051422490	023614251569	39 oz.	11½"	9½"	539.99

NOTE: \*Weights listed are approximate.



**THE BEST OF THE BEST.**

More than a decade in development and refinement, the ground-breaking Browning Hi Power was the product of two of the greatest gun designers ever — John M. Browning and FN's Dieudonne Saive. Its magazine capacity, durability, accuracy and perfect ergonomics have placed the Hi Power on a pedestal, revered as one of the finest firearms ever produced.

# HI POWER PISTOL



**SAFETY**

A large, ambidextrous manual thumb safety is conveniently located on the frame just above the grip.



**SIGHTS**

Hi Power pistols are available with fixed, low-profile three-dot sights. The Hi Power Standard is also available with optional low-profile target sights that are adjustable for windage and elevation.



**MAGAZINE CAPACITY**

Double-stack magazine design. A 13-round magazine is standard in 9mm. 10-round models in 9mm are available where required by law. Follow state and local laws regarding magazine capacity.

*All Browning firearms are shipped with a free locking device to assist in the safe storage of firearms.*

**TRIGGER**

The light single-action trigger breaks clean and crisp. This is the system preferred by professionals around the world.



**FRAME AND SLIDE**

The frame and slide are built from solid steel, yet remain lightweight. The heft of the Hi Power keeps recoil light and manageable for accurate firing, even at a rapid rate. The Hi Power's balance in your hand is impeccable.



**HI POWER MARK III (FIXED SIGHTS)**



**RECEIVER** - Steel · Black epoxy finish  
**BARREL** - 4 5/8" · Black epoxy on slide  
 · Low profile fixed sights  
**ACTION** - Locked breech · Single-action trigger  
 · Ambidextrous thumb safety  
**GRIPS** - Composite panels · Thumb rest  
**FEATURES** - Extra magazine

**HI POWER STANDARD (FIXED OR ADJUSTABLE SIGHTS)**



**RECEIVER** - Steel · Polished blued finish  
**BARREL** - 4 5/8" · Polished blued finish on slide · Low profile fixed or adjustable rear sights with ramped front post  
**ACTION** - Locked breech · Single-action trigger · Ambidextrous thumb safety  
**GRIPS** - Select walnut · Cut checkering  
**FEATURES** - Extra magazine

MODEL	FINISH	GRIPS	BARREL LENGTH	10 CAPACITY CODE/UPC #	13 CAPACITY CODE/UPC #	*AVG. WEIGHT	OVERALL LENGTH	SIGHT RADIUS	SUGG. RETAIL
<b>HI POWER MARK III, FIXED SIGHTS (SHOWN)</b>									
9mm	Black Epoxy	Molded Composite	4 5/8"	051001393 023614629924	051002393 023614237648	32 oz.	7 3/4"	6 1/16"	\$999.99
<b>HI POWER MARK III 75TH ANNIVERSARY EDITION, FIXED SIGHTS</b>									
9mm	Black Epoxy	Molded Composite	4 5/8"	051036393 023614070146	051037393 023614070153	32 oz.	7 3/4"	6 1/16"	\$999.99
<b>HI POWER STANDARD, FIXED SIGHTS</b>									
9mm	Blued	Walnut	4 5/8"	051003393 023614629931	051004393 023614679486	32 oz.	7 3/4"	6 1/16"	\$1,029.99
<b>HI POWER STANDARD 75TH ANNIVERSARY EDITION, FIXED SIGHTS</b>									
9mm	Blued	Walnut	4 5/8"	051034393 023614070122	051035393 023614070139	32 oz.	7 3/4"	6 1/16"	\$1,029.99
<b>HI POWER STANDARD, ADJUSTABLE SIGHTS (SHOWN)</b>									
9mm	Blued	Walnut	4 5/8"	051003493 023614629948	051004493 023614679493	32 oz.	7 3/4"	6 1/2"	\$1,099.99
<b>HI POWER STANDARD 75TH ANNIVERSARY EDITION, ADJUSTABLE SIGHTS</b>									
9mm	Blued	Walnut	4 5/8"	051032493 023614070108	051033493 023614070115	32 oz.	7 3/4"	6 1/2"	\$1,099.99

NOTE: \*Weights listed are approximate.

**SPECIAL ENGRAVING** To commemorate the 75th Anniversary of the Hi Power, select pistols are adorned with this special engraving on the top of the slide.



**EXTRA MAGAZINES**

CALIBER	CODE NUMBER	UPC #	SUGG. RETAIL	CALIBER	CODE NUMBER	UPC #	SUGG. RETAIL
<b>EXTRA HI POWER PISTOL MAGAZINES (10-SHOT CAPACITY)</b>				<b>EXTRA HI POWER MAGAZINES (13-SHOT CAPACITY)</b>			
9mm, S.A., H.P., Standard	112050193	023614630012	\$59.99	9mm, S.A., H.P., Standard	112050293	023614644736	\$69.99
9mm, S.A., H.P., Pachmayr®	112051193	023614630029	59.99	9mm, S.A., H.P., Pachmayr®	112051293	023614644743	69.99
40 S&W, S.A., H.P., Standard	112050194	023614630036	59.99				
40 S&W, S.A., H.P., Pachmayr®	112051194	023614644477	59.99				



# CUSTOM SHOP

## OWN A PIECE OF BROWNING HISTORY. STRAIGHT FROM THE BELGIAN CUSTOM SHOP.

John M. Browning's relationship with Fabrique Nationale began in the late 1800s, with the factory turning many of the fabled designer's most famous firearms. Today, hand-crafted firearms from the Browning Custom Shop in Belgium are revered as functional pieces of art, embellished to your preferences. Choose from time-honored Browning designs such as the legendary Superposed, BAR® and Hi Power™, carefully manufactured and hand-assembled to ensure your investment will be enjoyed and shared for generations. For information, call (801) 876-2711 or visit [browning.com/custom](http://browning.com/custom) to download the Custom Shop brochure to view the options available.

### B25 SUPERPOSED



B25 SP Duck

The most requested Custom Shop model is the legendary Superposed, the last design undertaken by John M. Browning before his death in 1926 and the culmination of his firearms ingenuity and wisdom. The Superposed is the finest and most respected over and under design ever. As in all of Browning's work, the Superposed delivers perfect balance, economy of proportion and eye-appealing design. As beautiful as a custom Superposed is, it demands to be carried afield and used, just as Mr. Browning intended.



Left side engraving details



DIANA™



MIDAS™



PIGEON



B25 GRADE C11



B25 GRADE D11



B25 GOLD



B25 SPECIAL DUCK



B25 GRADE B26



B25 GRADE C12



B25 GRADE D12



B25 SPECIAL WOODCOCK



B25 EVOLUTION



B25 GRADE C26



B25 GRADE D56



B25 GRADE I1



B25 GRADE E1



B25 GRADE F1



B25 GRADE M1



B25 GRADE M2



**EXPRESS RIFLES**



*CCS 25 Pursuite*

A solid action frame with a reinforced lock, thickened barrels and a pistol grip stock make a Browning Express rifle the perfect firearm for dangerous game hunting and African safaris. Available in 270 Win., 30-06 Sprg., 30R Blaser, 7x65R, 8x57JRS, 9.2x62 or 9.3x74R calibers.



*CCS 25 Grade B2E (Left)*

*CCS 25 Grade Bavarian (Left)*



*CCS 25 Grade D5G (Left)*

*CCS 25 Grade M1 (Left)*

**BAR**



Detailed hand engraving, high-grade wood and expert assembly at the Custom Shop place these BAR rifles in a league of their own. Please contact the Custom Shop for a complete list of engraving options. It is available in 243 Win., 25-06 Rem., 30-06 Sprg., 270 Win., 308 Win., 300 Win. Mag., 7mm Rem. Mag. or 338 Win. Mag. calibers.





**SEMI-AUTO 22 LUXE**



SA-22 GRADE III

SA-22 GRADE II (RIGHT)

SA-22 GRADE III (RIGHT)

The most widely sold and most imitated .22 autoloader. This rimfire is particularly light and efficient. The barrel and receiver can be separated in an instant. It is available in numerous versions, including the deluxe models, which continue to be made in the Custom Shop.

**HI POWER LUXUS**



GP GRADE II

GP RENAISSANCE ARGENT

GP GRADE B2

GP RENAISSANCE OR

The Browning Hi Power is one of the greatest pistol designs of all time. A custom Hi Power offers all the engineering genius of John M. Browning embellished with the beauty and craftsmanship provided by the Browning Custom Shop. A Hi Power Luxus pistol must be held to be fully appreciated.

**CUSTOM MADE IN BELGIUM**

The Custom Gun Shop of Fabrique Nationale and the Herstal, Belgium Engravers' Cooperative, will make available on special order many different custom enhancements. These firearms will be



fully assembled, fitted and engraved in Belgium to the personal designs and specifications of the shooting enthusiast.

**PRICE**

Prices for the basic firearm, before custom enhancement, are available from the sales department at Browning in Morgan, Utah by calling (801) 876-2711. All prices are subject to change due to changing world currencies.

**BROWNING**

BROWNING.COM/CUSTOM



**HOW TO ORDER**

All inquiries for Custom Gun Shop products will be submitted to headquarters in Morgan, Utah. Once the basic specifications have been determined, a written order should be placed with the Morgan office. The specifications will be reviewed with the Custom Shop in Belgium, and a price and delivery date will be determined.

**DELIVERY**

Actual production time will be based on the complexity and detail of the custom order. An approximate delivery date will be furnished with the factory cost quotation.





# SAFES

## BROWNING PROSTEEL SAFES — SECURITY AND CONVENIENCE.

For nearly 30 years, owners of Browning ProSteel safes have slept well knowing that their most prized possessions are safe and secure from fire, theft and untrained hands. In addition to security, Browning ProSteel safes lead the way in convenience, with more gun storage and easier access to safe contents than the competition. This tradition continues in 2011 — just take a look inside to see why Browning is The Best There Is.

### SAFES INDEX

#### ACCESSORY/OPTION INFORMATION

Factory-Installed Accessories	114
Game Scenes	111
Heritage Graphics	111
Interior Options	114
Lock Options	114
User-Installed Accessories	113

#### FEATURE INFORMATION

Axis Adjustable Shelving	90
Competitive Comparison	93
DPX Storage System	91
Feature Guide	94
Pry and Fire Resistance	92
Storage Solutions/Interiors	90-91
Understanding Safe Features	95

#### SAFES: PREMIUM

Gold Series	98-99
Medallion Series	100-101
Platinum Plus Series	96-97
Silver Series	102-103

#### SAFES: VALUE

Bronze Series	104-105
Compact Series	105
TheftGard	106-107

#### SAFES: SPECIALTY

Heritage Graphics	111
Security Door	112
Select Series	110
Tactical Series	108-109
Universal Vault Door	112

#### SUPPORTING INFORMATION

Warranty	114
----------	-----





**AXIS ADJUSTABLE SHELVING SYSTEM**

**NEW**



**THE MOST VERSATILE SAFE INTERIOR. EVER.**

A safe is capable of securing more than firearms. Jewelry, documents, cameras, coin collections and other valuables — plus shooting gear — can easily fit inside a safe. The trick is maximizing storage capacity to accommodate many different items of varying size. Browning ProSteel Safes have led the industry for years in terms of safe storage solutions, and for 2011 we take the concept to the highest level yet with our innovative Axis Adjustable Shelving (patent pending). Unlike shelves in other safes that are either

fixed in position or only offer vertical adjustment, Axis shelves can be adjusted both vertically and horizontally to accommodate nearly any size item while working around long guns. The new Axis Adjustable Shelving comes standard on all Platinum Plus® and Gold® Series safes. It is also available as a factory installed option on Medallion® and Silver® Series safes. Check it out today and see how much more you can store in your Browning ProSteel safe.

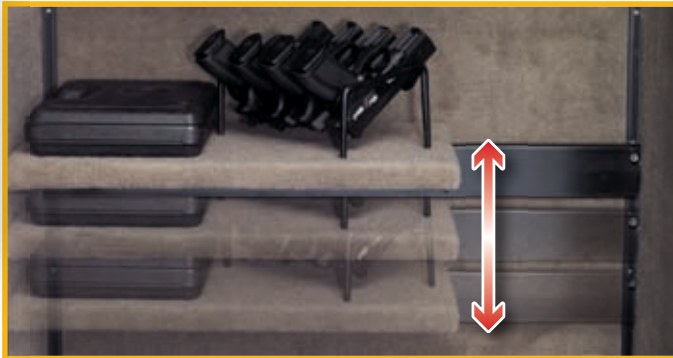

A vertical track mounted to the back of the safe interior allows the horizontal rail to be repositioned up or down along the vertical axis.



The cantilevered design of the Axis Adjustable Shelving can be placed anywhere left or right along the horizontal axis. Shelving can also be combined to make one long shelf.

From all gun to all shelves and all points in between, Axis Adjustable Shelving offers more versatility than any safe shelving available.



Arrangement Option #1

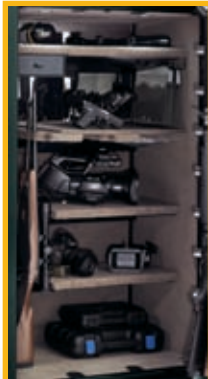

Arrangement Option #2



Arrangement Option #3

**AXIS ADJUSTABLE SHELVING FACTORY INSTALLED OPTION**

Axis Adjustable Shelving comes standard on all Platinum Plus and Gold Series safes. It is also available as a factory-installed option on Medallion and Silver Series safes.

Suggested Retail: \$149.00





**DPX STORAGE SYSTEM**



**OFTEN IMITATED. NEVER DUPLICATED.**

It is said that imitation is the sincerest form of flattery. When it comes to the Browning ProSteel patented DPX® storage system (U.S. patent #7,409,790), consider us flattered. While other safe companies have begun adding storage options that make better use of unused space on the back of their safe doors, none can match the convenience, versatility, or style of our original DPX® Storage System. In addition to being able to store

items in the pouches and pockets, long guns can be stored on the door back giving you two, three, even four times the number of quickly accessible long guns compared to the competition. Up to four handgun pouches (included) can also be positioned using the loop system. No other safe company offers as many versatile storage options on so many of their safe models.

DPX STORAGE SYSTEM

The patented Duo-Plus Extra (DPX) Storage System includes:

- Long gun storage on the door back
- A system of pouches and pockets to store small valuables on the door back
- DPX Handgun Pouches to store handguns on the door back or inside the safe
- A convertible Duo Interior system inside the safe with both shelves and long gun capacity

The DPX System is standard on the following safe series:

- Platinum® Plus
- Silver®
- Select™
- Gold®
- Bronze®
- Tactical
- Medallion®
- Theftgard® (top half only - select models)

CAPACITY COMPARISON Up to 30% more than other safes	Browning ProSteel 26 Cu. Ft. Model	Other Brand 25-28 Cu. Ft. Safe
Long Gun Capacity with Side Shelves in place	17 guns	11-14 guns
Fast Access Guns	9 guns	2 guns
Gun Locations	Interior and door back	Interior only

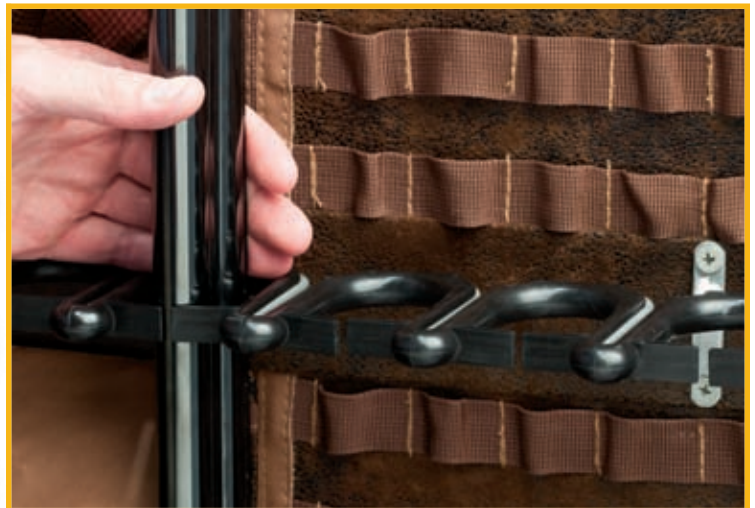

QUICK ACCESS DPX BARREL RACKS

Flexible polymer wings on the Quick Access DPX Barrel Rack hold the barrel in place, yet bend to allow the firearm to easily be pushed into or pulled out of the rack. It's standard on Platinum Plus, Gold, Medallion and Silver Series safes.

HOW MANY GUNS CAN I STORE IN MY BROWNING PROSTEEL SAFE?

The gun capacity description is a series of three numbers, for example 11/22+7. The first number is the long gun capacity of the main interior portion of the safe, with part of the space used for shelves (11 in the example). The second number is the interior long gun capacity if the shelves are removed for an all gun interior (22 in the example). The "plus" number (+7 in the example) is the long gun capacity on the back of the door. The door back capacity can be used to store long guns whether or not shelves are used in the interior. Since capacity is determined by safe size and features, each safe will have different interior capacities.



## FAIL-SAFE SECURITY.

For fail-safe security, look no further than the leaders in the safe industry, Browning and ProSteel. Our safes are manufactured with innovative, reinforced design features that ensure strength, security

and protection for your firearms and valuables. It's good to have a back-up plan. That's why you'll find anti-pry bolt supports, diversion bars and extra lock protection on every safe we build.

Four key design areas contribute to superior pry resistance: (1) A rigid door, (2) A rigid safe body, (3) A stiff locking bolt assembly and (4) Superior bolt engagement in the door frame. All four have been designed into Browning ProSteel Safes for better protection against pry attacks.

Safe corners are vulnerable to a pry attack, and great efforts have gone toward addressing the corners to make them nearly impenetrable to pry attack. Our Pry-Stop Corner Bolts (Platinum® Plus, Gold® and Medallion® Series safes) and Pry-Stop End Bolts (Silver®, Bronze®, Select™ and Tactical) plus Anti-Pry Tabs and extension arms in the Uni-Force™ Locking System make corners and crucial moving parts more pry-resistant. Tight-tolerance door fit makes it more difficult to get a prying tool into the door gap, while thicker doors make it harder to get a pry tool behind the door.

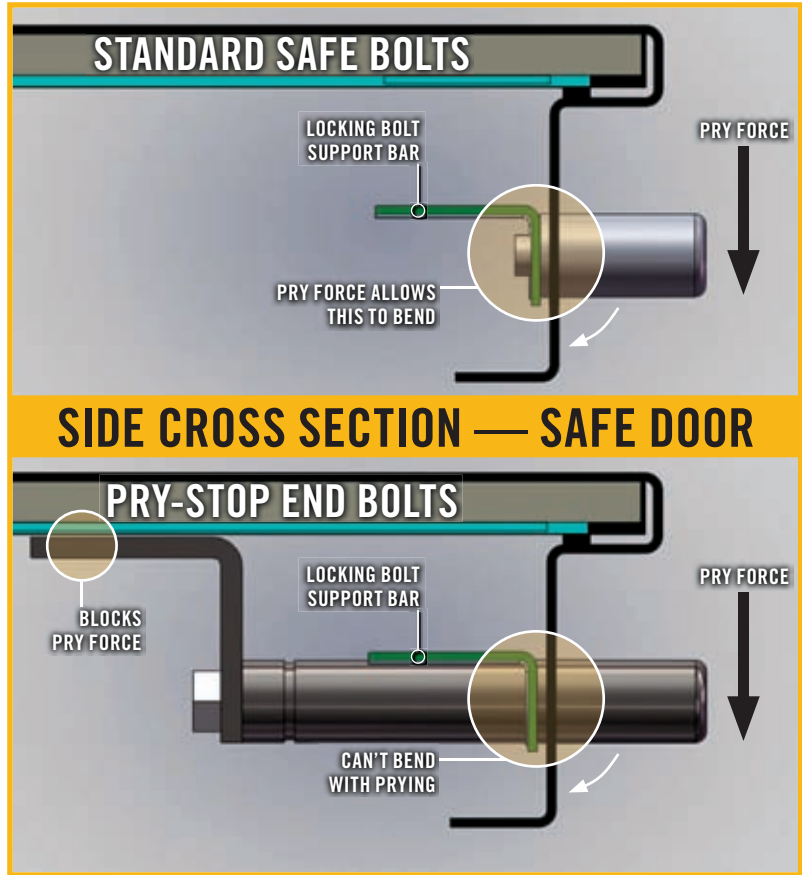

## FIRE RESISTANCE.

There are no industry standards for rating gun safe fire protection. This leads to confusing ratings that vary by manufacturer, and you are left to trust the manufacturers' claims. A Browning ProSteel safe backs up your trust with advanced fire protection features and a proven record of providing quality products for over 100 years. Browning

ProSteel Safes are tested for fire resistance beyond much of the competition, only then a label is applied with an honest fire protection rating. Extensive testing, industry-leading engineering and decades of experience go into building Browning ProSteel Safes in order to provide excellent fire resistance.

### WHAT MAKES A SAFE FIRE-RESISTANT?

The amount of insulation, placement of insulation, steel thickness, fire seal and other design elements (rigid door, external hinges, formed door design) are all crucial factors.

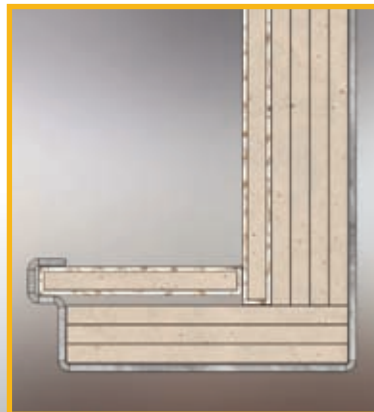

When comparing fire ratings, remember, the overall thickness of the insulation is the most important element in fire protection, and more insulation means better protection. Be confident that Browning ProSteel Safes offer excellent fire protection to protect your valuables in case of fire. Different ratings are useful for comparing fire protection in each Browning ProSteel safe series.





# PROTECTION YOU CAN RELY ON.

With a reputation for quality, innovative, reliable and beautiful firearms, Browning is one of the most respected names in the outdoor industry. Browning ProSteel Safes uphold those same values by offering high-quality attack- and fire-resistant safes designed to protect your possessions, and look good doing it. Our safes not only look

fantastic on the outside, the security and fire protection features inside of the safes are equally as impressive. While the looks of a safe matter, they only accent the features and construction that protect your belongings. A safe is a long-term investment, so be sure to invest in a Browning, The Best There Is®.

## COMPETITIVE COMPARISON

### BROWNING PROSTEEL SAFES

When comparing a Browning ProSteel safe to the competition, it's clear to see that there really is no comparison. Here's why Browning is The Best There Is®:

### LESSER SAFES

#### 1 ▶ STORAGE SYSTEM

Every Browning ProSteel Safe includes a Storage System to maximize capacity, organization and location of your valuables. The pockets, pouches and racks mounted on the back of the door provide amazing flexibility to store a variety of items.



#### 1 ▶ INTERIOR

Other safes simply come with an "interior" that doesn't maximize the storage capacity of the safe. The door back is wasted space. In some cases you must even assemble the shelves yourself. Interior hinges may only allow the door to open part way.

#### 2 ▶ SAFE LOCKING MECHANISM

##### Uni-Force™ Locking System –

Our premier locking mechanism (shown) uses robust cam locks and a large, multiple diversion bar system to prevent bolt or handle pressure from reaching the lock. Forces go to the cams and diversion bars, not the lock, creating protection unmatched by any other locking system.



#### 2 ▶ SAFE LOCKING MECHANISM

A lesser locking mechanism allows force from the bolts or handle to reach the critical lock. The only protection for the safe is an after-the-fact relocking device.

#### 3 ▶ DOOR CONSTRUCTION

For better security, the door must be designed and built to protect against multiple types of attack, and must engage the safe body in a manner that prevents break in. Browning ProSteel safe doors provide extra protection in the areas most susceptible to attack and are more resistant to pry, drill and punch attacks.

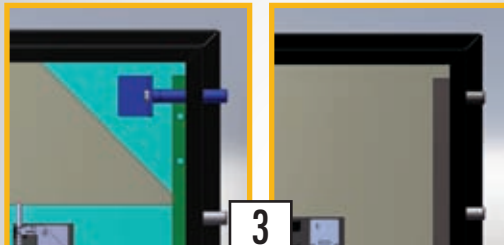

#### 3 ▶ DOOR CONSTRUCTION

Other safe doors may have weak points at the corners, and the locking bolts may be attached to a bar that is easily bent, both making the safe easier to pry open.

#### 4 ▶ FIRE INSULATION / PALUSOL® FIRE SEAL

Browning ProSteel Safes have up to five layers of 1/2" insulation. Thickness of insulation is the most important factor in fire protection.

The Palusol seal used on Browning ProSteel fire-resistant safes extends around the door so it is completely sealed in case of a fire. When heated, the Palusol expands to seal the door frame.

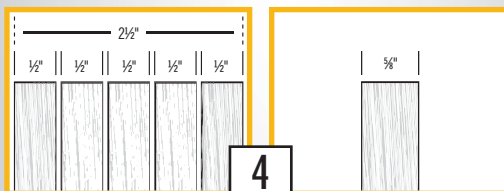

#### 4 ▶ FIRE INSULATION / FIRE SEAL

Some manufacturers claim high temperature or long duration fire ratings with as little as 1/2" of insulation, and they may not want to tell you how much (or little) insulation is in the safe. Lesser safes have gaps in the insulation and the fire seal, and may use a lesser quality fire seal. Internal hinges may create large gaps in the insulation.

#### 5 ▶ REINFORCED DOOR FRAME

Browning ProSteel Safes have an integrated reinforcement bent into the door frame of every model. The reinforcement is the actual steel thickness of the body with no welds for superior strength and makes the safes more pry-resistant.

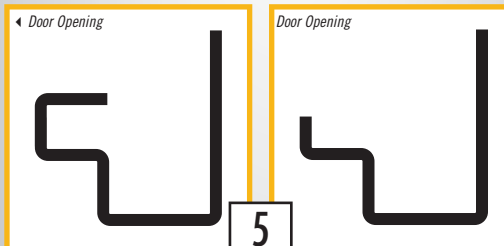

#### 5 ▶ NON REINFORCED DOOR FRAME

Some safe manufacturers cut costs by not reinforcing the door frame. This fails to protect against prying or pounding, making the door itself a prime target for attack.

#### 6 ▶ CONTINUOUS WELDS

Browning ProSteel Safes are constructed with continuous welds for optimal strength.

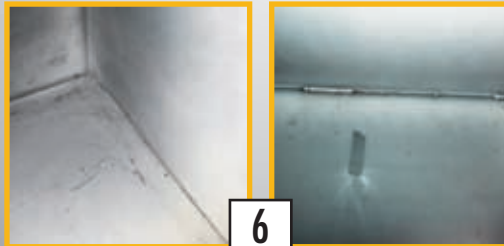

#### 6 ▶ INTERMITTENT WELDS

Some lesser safes have intermittent welds, which create weak points in the safe body. Gaps in welds can also create the perfect pry point for a burglar. Gaps filled with auto body putty and painted over are weak, even if you can't see them.













## SAFE FEATURE ICONS

The icons below highlight key features of Browning ProSteel Safes, and help you quickly identify and compare the features of different safe models.



## FIRE/SECURITY RATINGS

Fire and Security thermometers make it easier to compare the level of protection Browning ProSteel Safes provide in these two important areas. The “F” indicates fire protection and the “S” indicates security level. Higher numbers mean better protection.

	<p><b>FORCE DEFLECTOR™ LOCKING SYSTEM –</b> The Force Deflector Locking System (patent pending) prevents bolt or handle forces from reaching the lock by using a rotating cam device. It prevents energy transfer to the lock better than most systems used in the safe industry.</p>		<p><b>PRY-STOP CORNER BOLTS –</b> Pry-Stop Corner Bolts provide better protection than other pry-defense designs. Innovative long locking bolts extend diagonally from a reinforced support at the corners of the door to protect against pry attack at the vulnerable corner areas.</p>
	<p><b>UNI-FORCE™ LOCKING SYSTEM –</b> Our finest safe locking mechanism uses robust cam locks and a large, multiple diversion bar system to prevent bolt or handle pressure from reaching the lock. Forces go to the cams and diversion bars, not the lock, for protection unmatched by other locking systems.</p>		<p><b>PRY-STOP END BOLTS –</b> Superior to other bolt designs which allow the locking bolt support bar to bend. Pry-Stop End Bolts are over 2½ times longer and attach to a high-strength steel angle iron which prevents the locking bolt support bar from bending in a pry attack. The top and bottom locking bolts on the door side secure the critical door corners.</p>
	<p><b>1" FORMED DOOR –</b> The 1" Formed Door is engineered with a rugged steel face, back and reinforcement panels to provide excellent strength and attack protection compared to the competition.</p>		<p><b>LOCKING BOLTS (VARIABLE SIZE) –</b> The rugged steel pieces that move behind the door frame to actually hold the safe door locked and closed. Bigger bolts, and more of them, provide greater security.</p>
	<p><b>DUO-FORMED® DOOR –</b> The best safe door we offer is formed from multiple layers of steel, carefully formed together to provide superior strength, pry-resistance and attack protection. Full second panel for outstanding strength. The door face is 1⅛" thick.</p>		<p><b>BOLT DIRECTION –</b> Better safes have locking bolts extending from all four sides of the door for extra resistance to pry attack. Safes with bolts on three sides have them on both sides of the door and on the top edge.</p>
	<p><b>OMNIBARRIER® LOCK PROTECTION SYSTEM –</b> A carefully engineered structure of steel hard plate and steel components designed to protect the safe lock from drill, punch and push attacks.</p>		<p><b>BODY THICKNESS (VARIABLE MEASURE) –</b> The thickness of the steel that comprises the safe body. A smaller gauge number means thicker steel, which provides more security than thinner steel. The thickest Browning ProSteel Safe body is ⅜" (on Platinum® Plus) and this specification is not shown in gauge measurement.</p>
	<p><b>FIRE RATING (VARIABLE TIME) –</b> A laboratory measurement of time and temperature (in Fahrenheit) used to compare the relative amount of fire resistance provided by a safe. Safes with a longer fire rating time provide more fire protection than a safe with a shorter time.</p>		<p><b>DRILL-RESISTANT DEFLECTOR PLATE –</b> A hardened steel plate strategically positioned at an angle in the door which causes drill bits to bend or break, providing additional protection for the lock.</p>
	<p><b>LAYERS OF INSULATION –</b> The most important factor in fire protection is the total thickness of the insulation in the safe. More insulation means more protection from fire. Our safes use ½" thick gypsum panels, so the number of layers multiplied by ½" shows the total insulation thickness in inches.</p>		<p><b>LIGHT PACKAGE / MIRROR –</b> The interior light package includes two light modules to illuminate the safe interior. A mirror covers the top half of the rear wall of the safe. Combined, they make it easier for you to find items inside the safe.</p>
	<p><b>REINFORCED DOOR FRAME –</b> The door opening of the safe is strengthened by a U-shaped steel channel around the entire perimeter to create added pry and attack resistance.</p>		<p><b>DPX® SYSTEM –</b> The patented Duo-Plus Extra Storage System includes a rack to store long guns on the door back. There is also a variety of pouches and pockets to store other valuables on the door back. See page 91 for a complete description.</p>
	<p><b>180° HEAVY DUTY HINGES –</b> Rugged hinges are machined from solid steel bar stock for strength. The hinges allow the door to swing open 180° for unhindered access to the safe interior. Hinge-side locking bolts maintain full security even if the hinges are cut off. The door is removable to simplify moving of the safe.</p>		<p><b>AXIS™ –</b> New Axis Adjustable Shelving is the most versatile on the market. By combining multiple, moving shelves and an array of tracks, small and large items alike now fit in the safe and take up only the minimum amount of shelf space. See page 90 for a complete description.</p>
	<p><b>UL® SECURITY CONTAINER RATING –</b> The industry standard test and rating for home/personal safes. Requires minimum construction specifications and passing a laboratory attack test. Our premium safes far exceed the minimum requirements for the UL Residential Security (Tool Attack) listing.</p>	<div data-bbox="771 1785 1461 1837" style="background-color: #FFD700; padding: 5px;"><b>WHY STEP UP?</b></div> <p>Starting with the flagship Platinum Plus Series, there is a “Why Step Up?” section at the top of the description area for each series. This section is a list of just the features that distinguish that series from the series below (to the next page or pages) in the safe line up. “Why Step Up?” is an easy comparison between Browning ProSteel Safe series.</p>	



## WHAT YOU SHOULD KNOW BEFORE BUYING A GUN SAFE.

Not all gun safes are the same. Different safes offer more or less protection, depending on the features included in the safe. This quick guide helps explain different feature areas and the comparative

protection offered by individual features. You can determine the level of protection you want and need, and choose a safe that best meets those needs.

### SECURITY

#### LOCKING SYSTEM

The locking system connects the lock with the handle and the locking bolts. Better systems are engineered to protect against differing types of criminal attack.

**BEST** – **Uni-Force™ System** — Ultimate protection against pry and side bolt attacks. Includes the OmniBarrier® System that encases the lock in steel and hard plate, protecting it against drill and punch attack.

**BETTER** – **Force Deflector™ System** — Better than most industry systems protecting against side bolt attack. Includes a secondary re-locker, hard plate and hardened pin lock protection to defend against attacks on the lock.

**GOOD** – **Standard Locking System** — Does not provide protection against side bolt attack. All Browning ProSteel Safes feature either the Uni-Force or Force Deflector Systems to defend against side bolt attack.

#### DOOR THICKNESS

A thicker, more rigid door is better able to resist pry attacks. A door formed from multiple pieces of steel is more rigid because strategic bends in the metal add strength. A formed door also includes fire insulation, and therefore provides more fire protection.

**BEST** – **Duo-Formed® Door** — 1½" thick door face. Full steel interior panel.

**BETTER** – **1" Formed Door** — 1" thick door face. Steel reinforcement panels.

**GOOD** – **Plate Door** — ¾" thick solid steel door face. All Browning ProSteel Safes have a Best or Better type door.

#### STEEL THICKNESS

Thicker steel means more protection from any type of criminal attack and from fire.

**BEST** – ¾" Steel — Equivalent to about 6.5 gauge, 0.1875" thick.

**BETTER** – 10 gauge or 11 gauge — 0.135" or 0.12" thick.

**GOOD** – 12 gauge — 0.105" thick.

#### LOCKING BOLT DESIGN, NUMBER AND PLACEMENT

Better designed locking bolt structures and bigger bolts provide more pry resistance. Top, bottom and corner placement also improve protection against prying.

**BEST** – **Pry-Stop Corner Bolts, four-sided coverage** — 1½" or 1¼" bolts.

**BETTER** – **Pry-Stop End Bolts, three- or four-sided coverage** — 1¼" or 1" bolts.

**GOOD** – **Standard Locking Bolts, two-sided coverage** — 1" bolts.

### FIRE PROTECTION

#### INSULATION THICKNESS

More insulation means more protection. Insulation acts as a barrier and has a cooling effect. Thicker insulation is a better barrier.

**BEST** – **Five layers of ½" thick insulation** — So thick it is very visible.

**BETTER** – **Three or four layers of ½" insulation.**

**GOOD** – **One or two layers of ½" insulation.**

#### DOOR SEAL

The door seal activates during a fire to seal the interior of the safe from the fire on the outside. It prevents heat from getting in around the perimeter of the door and keeps the inside cooler. Works by expanding intumescent action in response to heat.

**BEST** – **Premium 3-in-1 Palusol® seal** — Palusol is the industry standard expanding door seal. Includes triple-fin protection for a tighter seal and protection against cold smoke damage.

**BETTER** – **Palusol® seal** — Industry standard expanding door seal. Expands five to nine times its original size.

**GOOD** – **Simple rubber seal** — All Browning ProSteel Safes use a Palusol® seal for better protection.

### CONVENIENCE

#### INTERIOR CONFIGURATION

A safe should allow maximum storage within its interior, and make it easy for the owner to access the items stored inside.

**BEST** – **AXIS™ with DPX® Storage System** — New Axis Adjustable Shelving combined with the DPX Storage System provides the most versatile safe interior available, allowing you to customize your safe to meet your specific and always changing storage needs.

**BETTER** – **DPX® Storage System** — Store long guns, handguns and many small items on the door back in a system of pouches, pockets and loops. Long gun and shelf storage inside the safe, convertible to all long gun.

**GOOD** – **Convertible long gun/shelf storage inside the safe** — No long gun storage on the door back.

### OTHER IMPORTANT FEATURES

All Browning ProSteel Safes also include: 180° Opening External Hinges for easy access to safe interior (except Compact Series). A steel reinforced door frame for superior pry resistance. Industry-standard mechanical or electronic locks. All Browning ProSteel Safes carry the UL® Residential Security Container rating.



PLATINUM PLUS SERIES



PP56F | PLATINUM PLUS SERIES SAFE  
 COLOR SHOWN: HUNTER GREEN METALLIC  
 Shown with optional Whitetail Buck/Doe scene

THE HEIGHT OF PROTECTION AND QUALITY

WHY STEP UP TO A PLATINUM PLUS SERIES SAFE?

- Heavy 3/16" steel body
- 1200°F/120 min. fire protection
- Grade VI interior package

ANTI-PRY FEATURES

- Ultra-heavy 3/16" steel body
- Pry-Stop Corner Bolts at all four corners of the door
- 1½" chromed locking bolts, four-sided door coverage
- Extended throw locking bolts
- Uni-Force™ Locking System with Anti-Pry Tabs and extension arms
- Fully reinforced integrated door frame
- Tight-tolerance door fit
- 1½" thick Duo-Formed® door

ADDITIONAL SECURITY FEATURES

- Uni-Force Locking System with four cams (three on PP39F)
- OmniBarrier® Lock Protection System
- Drill-resistant deflector plate
- UL® tool attack listed
- S & G® Group II lock with key lock dial and five-year limited warranty

INTERIOR/CONVENIENCE AND APPEARANCE FEATURES

- New Axis™ Adjustable Shelving
- Premium DPX® Storage System
- Quick Access DPX Barrel Rack
- Four DPX Handgun Pouches
- Integrated Jewelry Box
- Knurled five-spoke Buckmark handle
- Metallic Elk scene bonded to the safe door
- Elevated floor makes removing guns easier
- Baked-on, high-gloss finish

GRADE VI INTERIOR FEATURES

- Premium DPX Storage System with simulated leather trim
- Quick Access DPX Barrel Rack
- Interior cedar sides and ceiling
- Interior light package and full length mirror
- Worn leather look microfiber interior covering

1200° F/120 MIN. STANDARD FIRE PROTECTION

- 1200° F/120 min. fire protection
- Five layers of ½" fire-resistant insulation in the body
- Four layers of ½" fire-resistant insulation in the door
- Premium 3-in-1 Palusol® fire seal for added fire protection

PLATINUM PLUS SAFE SPECIFICATIONS

MODEL	CU. FT.	DIMENSIONS (H x W x D)	WEIGHT	BOLTS	GUN CAPACITY/INTERIOR	SUGGESTED RETAIL
NEW PP65F	65	72" x 56" x 28"	1,845 lbs.	28	21/53 + 13 DPX Tall	\$7,399.00
PP56F	56	72" x 48" x 28"	1,715 lbs.	28	21/45 + 10 DPX Tall	6,699.00
PP47F	47	72" x 40" x 28"	1,505 lbs.	28	22/33 + 10 DPX Tall	5,899.00
PP39F	39	60" x 40" x 28"	1,325 lbs.	24	22/33 + 10 DPX	5,199.00

NOTE: Black Cherry and Silver Metallic finish safes feature silver/chrome handle, dial ring and graphics. The handle, dial ring and graphics for all other finish colors are gold-colored. Scenes are not available on Sand Metallic colored safes.

AVAILABLE FINISHES

Hunter Green Metallic	Gloss Black	Black Cherry	Sand Metallic	Silver Metallic
-----------------------	-------------	--------------	---------------	-----------------

INTERIOR COLOR





PLATINUM PLUS SERIES



PP39F | PLATINUM PLUS SERIES SAFE  
COLOR SHOWN: GLOSS BLACK



PP65F | PLATINUM PLUS SERIES SAFE  
COLOR SHOWN: BLACK CHERRY



DPX® Handgun Pouch



1½" Pry-Stop Corner Bolts



Pry-Stop Corner Bolt Mechanism



Jewelry Box



**GRADE VI INTERIOR**

Platinum Plus Series safes feature the stunning Grade VI Interior Package. The Grade VI Interior creates interesting visual appeal with a full-length mirror on the back and cedar paneling on the sides and ceiling. The shelves are lined with distressed leather-look microfiber, and the DPX® system on the door back panel is trimmed in simulated leather. The new Axis™ Adjustable Shelving and DPX Barrel Racks offer the ability to store more than ever before.



**GOLD SERIES**



**G65F | GOLD SERIES SAFE**  
 COLOR SHOWN: SILVER METALLIC  
 Shown with optional Mule Deer scene

**PROTECTION AS GOOD AS GOLD**

**WHY STEP UP TO A GOLD SERIES SAFE?**

- New Axis™ Adjustable Shelving
- Additional Uni-Force™ cam and 1½" locking bolts
- Anti-Pry Corner Bolts at all four corners of the door
- Drill-resistant deflector plate
- 1200°F/100 min. fire protection
- Interior light package and mirror
- Knurled Buckmark handle
- New Integrated Jewelry Box

**ANTI-PRY FEATURES**

- Heavy 10-gauge steel body
- Anti-Pry Corner Bolts at all four corners of the door
- 1½" chromed locking bolts, four-sided door coverage
- Extended throw locking bolts
- Uni-Force Locking System with Anti-Pry Tabs and extension arms
- Fully reinforced integrated door frame
- Tight-tolerance door fit
- 1½" thick Duo-Formed® door

**ADDITIONAL SECURITY FEATURES**

- Uni-Force Locking System with three cams (four on G65F)
- OmniBarrier® Lock Protection System
- Drill-resistant deflector plate
- UL® tool attack listed
- S & G® Group II lock with key lock dial and five-year limited warranty

**INTERIOR/CONVENIENCE AND APPEARANCE FEATURES**

- Innovative Axis™ Adjustable Shelving for more storage options
- Premium DPX® Storage System
- Quick Access DPX Barrel Rack
- Four DPX Handgun Pouches
- Knurled five-spoke Buckmark handle
- Interior light package and mirror
- Metallic Pointer scene bonded to the safe door
- Elevated floor makes removing guns easier
- Baked-on, high-gloss finish

**1200° F/100 MIN. STANDARD FIRE PROTECTION**

- 1200° F/100 min. fire protection
- Five layers of ½" fire-resistant insulation in the body
- Four layers of ½" fire-resistant insulation in the door
- Premium 3-in-1 Palusol® fire seal for added fire protection

- 9 9 (Fire Protection)
- F S (Locking Bolts)
- 10 GA BODY (Steel Body)
- DUO FORMED DOOR (Door Construction)
- UNI FORCE (Locking System)
- OMNI BARRIER (Lock Protection)
- 1 1/2" (Locking Bolt Length)
- PRY-CORNER STOP BOLTS (Anti-Pry Feature)
- 4-WAY BOLTS (Locking System)
- UL (UL Listing)
- 180° (Interior Light)
- DPX (Storage System)
- AXIS (Adjustable Shelving)
- UL (UL Listing)
- 5 LAYERS INSULATION (Fire Protection)
- 1200°/100 (Fire Protection)
- UL LISTED 1P60 GUN SAFE (UL Listing)
- MADE IN USA (Origin)

**GOLD SAFE SPECIFICATIONS**

MODEL	CU. FT.	DIMENSIONS (H x W x D)	WEIGHT	BOLTS	GUN CAPACITY/INTERIOR	SUGGESTED RETAIL
<b>NEW</b> G65F	65	72" x 56" x 28"	1,665 lbs.	28	21/53 + 13 DPX Tall	\$5,849.00
<b>NEW</b> G39F	39	60" x 40" x 28"	1,165 lbs.	24	22/33 + 10 DPX	4,399.00
<b>NEW</b> G28F	28	60" x 30" x 27"	950 lbs.	24	11/22 + 7 DPX	3,629.00

*NOTE: Black Cherry and Silver Metallic finish safes feature silver/chrome handle, dial ring and graphics. The handle, dial ring and graphics for all other finish colors are gold-colored. Scenes are not available on Sand Metallic colored safes.*

**AVAILABLE FINISHES**

Hunter Green Metallic	Gloss Black	Black Cherry	Sand Metallic	Silver Metallic
-----------------------	-------------	--------------	---------------	-----------------

**INTERIOR COLORS**

Tan Carpet	Gray Carpet
------------	-------------



GOLD SERIES



G28F | GOLD SERIES SAFE  
COLOR SHOWN: BLACK CHERRY



G39F | GOLD SERIES SAFE  
COLOR SHOWN: HUNTER GREEN METALLIC



Interior Light Package and Mirror included



Knurled Buckmark Handle



**NEW**  
AXIS™ ADJUSTABLE SHELVING

We go to great lengths to maximize the storage capacity and versatility of safes. The new Axis Adjustable Shelving features track-mounted shelves that move up and down, and side to side, to let you fit more in the safe. Gold Series safes also include a light and mirror package to give the safe interior a more spacious feel and make it easier to find items in the safe. Factory installed only.



1 1/2" Pry-Stop Corner Bolts



**NEW**  
New Jewelry Box



MEDALLION SERIES



M56F | MEDALLION SERIES SAFE  
 COLOR SHOWN: GLOSS BLACK  
 Shown with optional Elk scene

SETTING THE STANDARD FOR PROTECTION AND VALUE

WHY STEP UP TO A MEDALLION SERIES SAFE?

- Heavy, 10-gauge steel body
- OmniBarrier® and Uni-Force™ Systems create a rugged, protected locking mechanism
- Pry-Stop Corner Bolts on two outside corners of door
- New Deluxe embossed five-spoke handle
- 1200° F/90 min. fire protection

ANTI-PRY FEATURES

- Heavy, 10-gauge steel body
- Pry-Stop Corner Bolts on the two outside corners of the door
- 1¼" chromed locking bolts, four-sided door coverage
- Extended throw locking bolts
- Uni-Force Locking System with Anti-Pry Tabs and extension arms
- Fully reinforced integrated door frame
- Tight-tolerance door fit
- 1½" thick Duo-Formed® Door

ADDITIONAL SECURITY FEATURES

- Uni-Force Locking System with two cams
- OmniBarrier Lock Protection System
- UL® tool attack listed
- S & G® Group II lock with key lock dial and five-year limited warranty

INTERIOR/CONVENIENCE AND APPEARANCE FEATURES

- Premium DPX® Storage System
- Quick Access DPX Barrel Rack
- Four DPX Handgun Pouches
- New Deluxe embossed five-spoke handle
- Elevated floor makes removing guns easier
- Metallic Whitetail Buck/Doe scene bonded to the safe door
- Baked-on, high-gloss or rugged textured charcoal finishes

1200°F/90 MIN. STANDARD FIRE PROTECTION

- 1200° F/90 min. fire protection
- Four layers of ½" fire-resistant insulation in the body and door (five layers in ceiling)
- Palusol® expanding fire seal

MEDALLION SAFE SPECIFICATIONS

MODEL	CU. FT.	DIMENSIONS (H x W x D)	WEIGHT	BOLTS	GUN CAPACITY/INTERIOR	SUGGESTED RETAIL (GLOSS FINISH)	SUGGESTED RETAIL (TEXTURED FINISH)
M56F	56	72" x 48" x 28"	1,365 lbs.	26	21/45 + 10 DPX Tall	\$4,429.00	\$4,179.00
<b>NEW</b> M47F	47	72" x 40" x 28"	1,190 lbs.	26	24/35 + 10 DPX	3,999.00	3,749.00
M39F	39	60" x 40" x 28"	1,050 lbs.	18	24/35 + 10 DPX	3,559.00	3,399.00
M28F	28	60" x 30" x 27"	855 lbs.	18	11/22 + 7 DPX	2,829.00	2,699.00

NOTE: Black Cherry, Silver Metallic and Textured Charcoal finish safes feature silver/chrome handle, dial ring and graphics. The handle and graphics for all other finish colors are gold-colored.

AVAILABLE FINISHES					
Hunter Green Metallic	Gloss Black	Black Cherry	Sand Metallic	Silver Metallic	Textured Charcoal
INTERIOR COLORS					
Tan Carpet			Gray Carpet		



MEDALLION SERIES



M28F | MEDALLION SERIES SAFE  
COLOR SHOWN: BLACK CHERRY  
*Shown with optional Mountain scene*



M47F | MEDALLION SERIES SAFE  
COLOR SHOWN: SAND METALLIC



*New Deluxe Embossed Five-spoke Handle*



*Pry-Stop Corner Bolt Mechanism*



**NEW**

**FACTORY INSTALLED OPTION:**

*The new Axis™ Adjustable Shelving is a factory installed option on Medallion Series Safes (see page 90).*



SILVER SERIES



SR26F | SILVER SERIES SAFE  
COLOR SHOWN: GLOSS BLACK

**AUTHENTIC VALUE**

WHY STEP UP TO A SILVER SERIES SAFE?

- 11-gauge steel body
- 1½" thick Duo-Formed® Door with full inner plate
- 1¼" door bolts on all four sides for extra security
- 1200°F/60 min. fire protection
- Quick Access DPX® Barrel Rack
- Attractive wildlife scene available
- Four DPX Handgun Pouches

ANTI-PRY FEATURES

- Rugged 11-gauge steel body
- Pry-Stop End Bolts
- 1¼" chromed locking bolts, four-sided door coverage
- Extended throw locking bolts
- Fully reinforced integrated door frame
- Tight-tolerance door fit
- 1½" thick Duo-Formed door

ADDITIONAL SECURITY FEATURES

- Force Deflector™ locking mechanism
- Hardened steel pin lock protection
- UL® tool attack listed
- S & G® Group II lock with key lock dial and five-year limited warranty

INTERIOR/CONVENIENCE AND APPEARANCE FEATURES

- New Premium DPX Storage System
- New Quick Access DPX Barrel Rack
- Four DPX Handgun Pouches
- Deluxe three-spoke handle
- Elevated floor makes removing guns easier
- Metallic Mallard scene bonded to the safe door
- Baked-on, high-gloss or rugged textured charcoal finishes

1200°F/60 MIN. STANDARD FIRE PROTECTION

- 1200° F/60 min. fire protection
- Three layers of ½" fire-resistant insulation in the safe body and door
- Palusol® expanding fire seal

**SILVER SAFE SPECIFICATIONS**

MODEL	CU. FT.	DIMENSIONS (H x W x D)	WEIGHT	BOLTS	GUN CAPACITY/INTERIOR	SUGGESTED RETAIL (GLOSS FINISH)	SUGGESTED RETAIL (TEXTURED FINISH)
SR42F	42	72" x 37" x 27"	940 lbs.	16/10 active	20/30 + 10 DPX Tall	\$3,079.00	\$2,879.00
SR35F	35	60" x 37" x 27"	820 lbs.	16/10 active	20/30 + 10 DPX	2,799.00	2,629.00
SR26F	26	60" x 30" x 25"	690 lbs.	16/10 active	10/20 + 7 DPX	2,249.00	2,119.00

NOTE: Black Cherry, Silver Metallic and Textured Charcoal finish safes feature silver/chrome handle, dial ring and graphics. The handle, dial ring and graphics for all other finish colors are gold-colored.

AVAILABLE FINISHES					
Hunter Green Metallic	Gloss Black	Black Cherry	Sand Metallic	Silver Metallic	Textured Charcoal
INTERIOR COLORS					
Tan Carpet			Gray Carpet		



SILVER SERIES



SR35F | SILVER SERIES SAFE  
COLOR SHOWN: SILVER METALLIC



**NEW**

**FACTORY INSTALLED OPTION:**  
The new Axis™ Adjustable Shelving is a factory installed option on Silver Series Safes (see page 90).



**NEW**

New Quick Access DPX® Barrel Racks

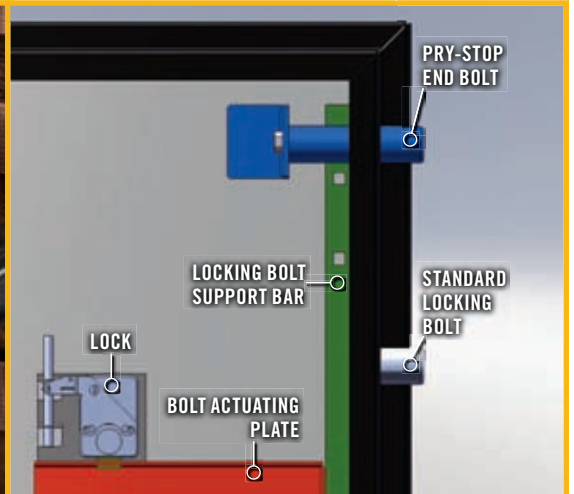

Pry-Stop End Bolt Mechanism



BRONZE SERIES



BR24F | BRONZE SERIES SAFE  
COLOR SHOWN: GLOSS BLACK

**AFFORDABLE SECURITY**

WHY STEP UP TO A BRONZE SERIES SAFE?

- 1200° F/45 min. fire protection
- Pry-Stop End Bolts for better pry resistance
- Available in premium gloss or rugged textured charcoal finishes
- Three-sided locking bolts
- New Full DPX® Storage System

ANTI-PRY FEATURES

- 12-gauge steel body
- Pry-Stop End Bolts
- 1" chromed locking bolts, three-sided door coverage
- Extended throw locking bolts
- Fully reinforced integrated door frame
- Tight-tolerance door fit
- 1" formed door

ADDITIONAL SECURITY FEATURES

- Force Deflector™ Locking System
- Hardened steel pin lock protection
- UL® tool attack listed
- S & G® Group II lock with key lock dial and five-year limited warranty

INTERIOR/CONVENIENCE AND APPEARANCE FEATURES

- DPX Storage System on top half of door back
- Two DPX Handgun Pouches
- Deluxe three-spoke handle
- Elevated floor makes removing guns easier
- Scroll graphic on the door
- Baked-on, high-gloss or rugged textured charcoal finishes

1200°/45 MIN. STANDARD FIRE PROTECTION

- 1200° F/45 min. fire protection
- Two layers of ½" fire-resistant insulation in the body and door
- Palusol® expanding fire seal

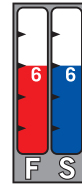

**BRONZE SAFE SPECIFICATIONS**

MODEL	CU. FT.	DIMENSIONS (H x W x D)	WEIGHT	BOLTS	GUN CAPACITY/INTERIOR	SUGGESTED RETAIL (GLOSS FINISH)	SUGGESTED RETAIL (TEXTURED FINISH)
BR41F	41	60" x 44" x 27"	805 lbs.	14/8 active	20/42 + 10 DPX	\$2,539.00	\$2,299.00
BR34F	34	60" x 36" x 27"	705 lbs.	14/8 active	20/30 + 10 DPX	2,179.00	1,949.00
BR24F	24	60" x 30" x 23"	535 lbs.	14/8 active	9/18 + 7 DPX	1,599.00	1,479.00
BR16F	16	60" x 24" x 19"	425 lbs.	9/5 active	7/14 + 5 DPX	1,429.00	1,299.00

NOTE: Textured Charcoal finish safes feature silver/chrome handle, dial ring and graphics. The handle and graphics on Gloss Black finish safes are gold-colored.

**AVAILABLE FINISHES**

Gloss Black	Textured Charcoal
-------------	-------------------

**INTERIOR COLOR**

Gray Carpet
-------------



**BRONZE SERIES**



BR34F | BRONZE SERIES SAFE  
COLOR SHOWN: GLOSS BLACK



BR16F | BRONZE SERIES SAFE  
COLOR SHOWN: TEXTURED CHARCOAL

**COMPACT SERIES**

COMPACT SIZE — LOADED WITH FEATURES

A premium, scaled-down Browning ProSteel safe, the Compact Series safe is the perfect size safe for smaller valuables such as jewelry, cameras, handguns or wherever space is at a premium.

COMPACT SERIES FEATURES

- 12-gauge steel body
- 1" formed steel door
- Force Deflector™ Locking Mechanism
- Hardened steel pin lock protection
- 1" chromed locking bolts
- Internal hinge system
- UL® tool attack listed
- Two layers of ½" fire-resistant insulation in the body and door
- 1200° F/45 min. fire protection
- Palusol® expanding fire seal
- UL Type I Electronic Lock
- Baked-on high-gloss finish
- Gray two-shelf interior



H9F | COMPACT SAFE

**COMPACT SAFE SPECIFICATIONS**

MODEL	CU. FT.	DIMENSIONS (H x W x D)	WEIGHT	BOLTS	GUN CAPACITY/INTERIOR	SUGGESTED RETAIL
H9F	9	30" x 24" x 20"	275 lbs.	3	2-Shelf/Gray	\$979.00
		Interior dimensions: 27" x 21 1/4" x 14"				

**AVAILABLE FINISH**

Gloss Black

**INTERIOR COLOR**

Gray Carpet



**THEFTGARD GRADE II**



TG23F | THEFTGARD SAFE  
COLOR SHOWN: HAMMER BROWN

**VALUE PLUS FEATURES**

THEFTGARD

- 1200° F/30 min. fire protection
- Thick 1" formed door with two-sided locking bolts
- New Half DPX® Storage System

ANTI-PRY FEATURES

- 12-gauge steel body
- 1" chromed locking bolts, two-sided door coverage
- Extended throw locking bolts
- Fully reinforced integrated door frame
- Tight tolerance door fit
- 1" formed door

ADDITIONAL SECURITY FEATURES

- Force Deflector™ Locking System
- Hardened steel pin lock protection
- UL® tool attack listed
- UL Group II lock with five-year limited warranty

INTERIOR/CONVENIENCE AND APPEARANCE FEATURES

- DPX Interior for long gun storage on the door
- New Deluxe three-spoke handle
- Scroll graphic on the door
- Rugged textured finish

1200° F/30 MIN. STANDARD FIRE PROTECTION

- 1200° F/30 min. fire protection
- One layer of ½" fire-resistant insulation in the body
- Two layers of ½" fire-resistant insulation in the door and ceiling
- Palusol® expanding fire seal



TG41F | THEFTGARD SAFE  
COLOR SHOWN: HAMMER GRAY

**THEFTGARD SAFE SPECIFICATIONS**

MODEL	CU. FT.	DIMENSIONS (H x W x D)	WEIGHT	BOLTS	GUN CAPACITY/INTERIOR	SUGGESTED RETAIL	SUGGESTED RETAIL (E-LOCK)
TG41F	41	72" x 36" x 27"	705 lbs.	7/4 active	20/30 + 10 Duo-Plus Tall	\$2,099.00	\$2,188.00
TG33F	33	58" x 36" x 27"	600 lbs.	7/4 active	20/30 + 10 Duo-Plus	1,615.00	1,704.00
TG23F	23	58" x 30" x 23"	510 lbs.	7/4 active	9/18 + 7 Duo-Plus	1,129.00	1,218.00

NOTE: Hammer Gray safes feature silver/chrome hardware and graphics. Hammer Brown safes have gold/brass hardware and graphics.

AVAILABLE FINISHES	
Hammer Gray	Hammer Brown
INTERIOR COLORS	
Gray Carpet	Tan Carpet



THEFTGARD GRADE I



TG20F | THEFTGARD SAFE

REAL SAFES AT A REAL VALUE

THEFTGARD

- 1200° F/30 min. fire protection
- Thick 1" formed door with two-sided locking bolts

ANTI-PRY FEATURES

- 12-gauge steel body
- 1" chromed locking bolts, two-sided door coverage
- Extended throw locking bolts
- Fully reinforced integrated door frame
- Tight tolerance door fit
- 1" formed door

ADDITIONAL SECURITY FEATURES

- Force Deflector™ Locking System
- Hardened steel pin lock protection
- UL® tool attack listed
- UL Group II lock with five-year limited warranty

INTERIOR/CONVENIENCE AND APPEARANCE FEATURES

- New Deluxe three-spoke handle
- Scroll graphic on the door
- Rugged textured finish

1200°/30 MIN. STANDARD FIRE PROTECTION

- 1200° F/30 min. fire protection
- One layer of ½" fire-resistant insulation in the body
- Two layers of ½" fire-resistant insulation in the door and ceiling
- Palusol® expanding fire seal



TG20F | THEFTGARD SAFE

THEFTGARD SAFE SPECIFICATIONS

MODEL	CU. FT.	DIMENSIONS (H x W x D)	WEIGHT	BOLTS	GUN CAPACITY/INTERIOR	SUGGESTED RETAIL	SUGGESTED RETAIL (E-LOCK)
TG20F	20	58" x 30" x 20"	460 lbs.	7/4 active	11/22 Duo	\$999.00	\$1,088.00
TG15F	15	58" x 24" x 18"	360 lbs.	7/4 active	9/18 Duo	959.00	1,048.00

NOTE: Hammer Gray safes feature silver/chrome hardware and graphics. Hammer Brown safes have gold/brass hardware and graphics.

<b>AVAILABLE FINISH</b>
Textured Black
<b>INTERIOR COLOR</b>
Gray Carpet



TACTICAL SERIES MARK II



AR26F | TACTICAL MARK II SERIES SAFE



AR35F | TACTICAL MARK II SERIES SAFE

UTILITY AND STYLE

MARK II KEY FEATURES

- Heavy 11-gauge steel body
- Conveniently holds shorter guns
- Interior mirror and light package make finding items easier
- External Accessory Rack makes it easy to hang gear on side of safe

ANTI-PRY FEATURES

- Heavy 11-gauge steel body
- Pry-Stop End Bolts
- 1¼" chromed locking bolts, four-sided door coverage
- Extended throw locking bolts
- Fully reinforced integrated door frame
- Tight-tolerance door fit
- 1½" thick Duo-Formed® door

OTHER SECURITY FEATURES

- Force Deflector™ Locking Mechanism
- Hardened steel pin lock protection
- UL® tool attack listed
- S & G® Type I Electronic Lock with five-year limited warranty

INTERIOR/CONVENIENCE AND APPEARANCE FEATURES

- DPX® Storage System with loops for short barrel guns
- New Quick Access DPX Barrel Rack
- Four DPX Handgun Pouches
- Tactical-look single handle
- Top Gear Loft conveniently stores gear on safe
- Side Rails and External Accessory Rack for hanging items outside safe
- Rubber-coated shelves
- Picatinny rails make for easy mounting of accessories inside safe
- Key fob holder and small item tray for even more storage versatility
- Full-length mirrored back panel and interior light package
- Raised-dot rubber floor panel
- Elevated floor makes removing guns easier
- Cast Browning name plate
- Tactical Black finish

1200° F/60 MIN. STANDARD FIRE PROTECTION

- 1200° F/60 min. fire protection
- Three layers of ½" fire-resistant insulation in the safe body and door
- Palusol® expanding fire seal



New Quick Access DPX® Barrel Racks

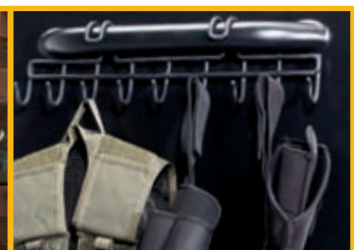

Mark II External Accessory Rack

TACTICAL MARK II SAFE SPECIFICATIONS

MODEL	CU. FT.	DIMENSIONS (H x W x D)	WEIGHT	BOLTS	GUN CAPACITY/INTERIOR	SUGGESTED RETAIL
AR35F	35	60" x 37" x 27"	860 lbs.	16/10 active	20/30 + 10 DPX	\$3,279.00
AR26F	26	60" x 30" x 25"	725 lbs.	16/10 active	10/20 + 7 DPX	2,729.00

Overall dimensions of AR35F and AR26F are 6" wider than shown and 4" taller than shown due to Gear Loft and Side Rails.

AVAILABLE FINISH

Tactical Black

INTERIOR COLOR

Gray Carpet



TACTICAL SERIES MARK I



AK33F | TACTICAL MARK I SERIES SAFE

UTILITY AND STYLE

MARK I KEY FEATURES

- Conveniently stores shorter guns
- Safe Top Gear Loft makes great use of space on top of safe
- Pry-Stop End Bolts provide excellent pry resistance

ANTI-PRY FEATURES

- 12-gauge steel body
- Pry-Stop End Bolts
- 1" chromed locking bolts, 3-sided door coverage
- Extended throw locking bolts
- Fully reinforced integrated door frame
- Tight-tolerance door fit
- 1" Formed door

OTHER SECURITY FEATURES

- Force Deflector™ Locking Mechanism
- Hardened steel pin lock protection
- UL® tool attack listed
- S & G® Type I Electronic Lock with five-year limited warranty

INTERIOR/CONVENIENCE AND APPEARANCE FEATURES

- DPX® Storage System with loops for short barrel guns
- Four DPX handgun pouches
- Tactical-look single handle
- Top Gear Loft conveniently stores gear on safe
- Picatinny rails make for easy mounting of accessories inside safe
- Half-height mirrored back panel
- Raised-dot rubber floor panel
- Elevated floor makes removing guns easier
- Cast Browning name plate
- Tactical Black finish

1200° F/45 MIN. STANDARD FIRE PROTECTION

- 1200° F/45 min. fire protection
- Two layers of ½" fire-resistant insulation in the safe body and door
- Palusol® expanding fire seal

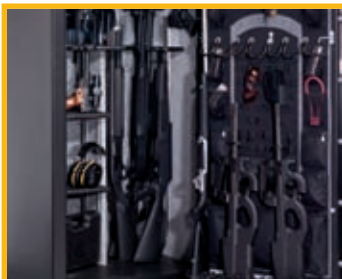

Short Guns on DPX®



AK23F | TACTICAL MARK I SERIES SAFE

TACTICAL MARK I SAFE SPECIFICATIONS

MODEL	CU. FT.	DIMENSIONS (H x W x D)	WEIGHT	BOLTS	GUN CAPACITY/INTERIOR	SUGGESTED RETAIL
AK33F	33	58" x 36" x 27"	715 lbs.	14/8 active	20/30 + 10 DPX	\$2,759.00
AK23F	23	58" x 30" x 23"	545 lbs.	14/8 active	9/18 + 7 DPX	2,229.00

Overall dimensions of AK33F and AK23F are 4" taller than shown due to Gear Loft.

**AVAILABLE FINISH**  
Tactical Black

**INTERIOR COLOR**  
Gray Carpet



SELECT SERIES FULL LINE DEALER



To combat drill attacks, some Browning ProSteel safes feature Hardened Steel Pin Lock Protection strategically placed directly in front of the locking mechanism. The smooth, rounded edges of the hardened steel pins are more difficult to drill through than additional steel plate reinforcement. The pins also rotate freely and, should an attack attempt be made, are likely to bend or break drill bits.

GREAT VALUE FROM PREFERRED DEALERS

KEY FEATURES

- Exclusively available from Browning Full Line and Medallion Dealers
- Interior light package and mirror
- Whitetail Buck/Doe scene or scroll graphics

ANTI-PRY FEATURES

- 12-gauge steel body
- Pry-Stop End Bolts
- 1" chromed locking bolts, three-sided door coverage
- Extended throw locking bolts
- Fully reinforced integrated door frame
- Tight-tolerance door fit
- 1" Formed door

OTHER SECURITY FEATURES

- Force Deflector™ Locking Mechanism
- Hardened steel pin lock protection
- UL® tool attack listed
- S & G® Group II lock with key lock dial and five-year limited warranty

INTERIOR/CONVENIENCE AND APPEARANCE FEATURES

- DPX® Storage System
- Two DPX Handgun Pouches
- Interior light package and mirror on top half of back
- Deluxe three-spoke handle
- Elevated floor makes removing guns easier
- Available with either Whitetail Buck/Doe scene or scroll graphic on the safe door
- Baked-on, high-gloss finish

1200° F/45 MIN. STANDARD FIRE PROTECTION

- 1200° F/45 min. fire protection
- Two layers of ½" fire-resistant insulation in the safe body and door
- Palusol® expanding fire seal



ST34F | SELECT SERIES SAFE  
COLOR SHOWN: GLOSS BLACK

Shown with Whitetail Buck/Doe Scene



SELECT SAFE SPECIFICATIONS

MODEL	CU. FT.	DIMENSIONS (H x W x D)	WEIGHT	BOLTS	GUN CAPACITY/INTERIOR	SUGGESTED RETAIL
ST34F	34	60" x 36" x 27"	710 lbs.	14/8 active	20/30 + 10 DPX	\$2,359.00
ST24F	24	60" x 30" x 23"	540 lbs.	14/8 active	9/18 + 7 DPX	1,799.00

AVAILABLE FINISHES

Hunter Green Metallic    Gloss Black

INTERIOR COLOR

Tan Carpet



### HERITAGE GRAPHICS

Now it is possible to show allegiance to these great organizations that work to preserve our rights and hunting heritage. The Heritage Graphics option can be ordered to replace the game scene on many safes. You can support your favorite organization by proudly showing its logo and graphics on a gorgeous Browning ProSteel safe.

Browning makes a donation to the respective organization for each Heritage Graphics option sold. Available on all safes in the Platinum® Plus, Gold®, Medallion® and Silver™ Series models (except Sand Metallic finishes).



HERITAGE GRAPHICS DU  
COLOR SHOWN: GLOSS BLACK



HERITAGE GRAPHICS NWTF  
COLOR SHOWN: HUNTER GREEN



HERITAGE GRAPHICS RMEF  
COLOR SHOWN: HUNTER GREEN



HERITAGE GRAPHICS NRA  
COLOR SHOWN: GLOSS BLACK



### GAME SCENE SELECTION

AVAILABLE ON PLATINUM® PLUS, GOLD®, MEDALLION® AND SILVER® MODELS

Each series (Platinum, Gold, etc.) has a standard metallic game scene. These scenes are permanently bonded to the door and can be applied only at the factory.



POINTER SCENE  
BY LUKE FRAZIER

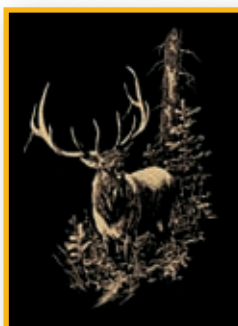

ELK SCENE  
BY LEON PARSON

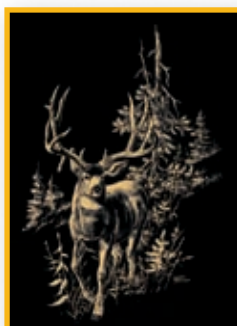

MULE DEER SCENE  
BY DAVID JACKSON

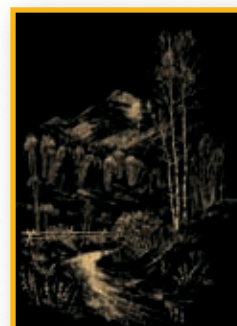

MOUNTAIN SCENE  
BY DAVID JACKSON



WHITETAIL BUCK/DOE SCENE  
BY LUKE FRAZIER

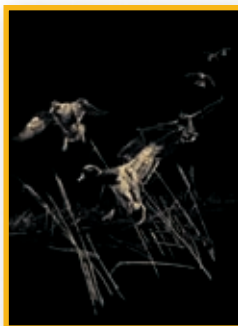

MALLARDS SCENE  
BY LUKE FRAZIER



BUCKMARK SCENE



PREMIUM SAFE SCROLL



## UNIVERSAL VAULT DOOR

### TURN AN ENTIRE ROOM INTO A VAULT

- Designed to fit a variety of wall types and installation requirements
- The minimum rough door opening for the Vault Door is 83" x 36"
- External L-frame with ½" diameter steel J-bolt anchors (included) can be poured in place in new construction or installed in an existing door frame by using expansion anchors or lag bolts (not included)

### UNIVERSAL VAULT DOOR FEATURES

- Door frame "L-flange" will fit any wall with a minimum thickness of 5½"
- 1½" thick Duo-Formed® door
- 22 1¼" chromed locking bolts
- OmniBarrier® Lock Protection System
- Uni-Force™ Locking System
- 1½" of fire-resistant insulation in the door
- Knurled five-spoke Buckmark handle
- External ball-bearing hinges
- Palusol® expanding fire seal
- UL® Listed S & G® Type I Electronic Lock
- Also available with a black primered finish, allowing you to paint to match any decor
- Internal lock release to open the door from within the vault

### UNIVERSAL VAULT DOOR SPECIFICATIONS

MODEL	WEIGHT	BOLTS	DOOR CONSTRUCTION	SUGGESTED RETAIL (GLOSS FINISH)	SUGGESTED RETAIL (PRIMER FINISH)
Vault Door	645 lbs.	22	10-gauge/12-gauge	\$3,189.00	\$3,019.00

NOTE: Black Cherry and Silver Metallic finish safes feature silver/chrome handle, dial ring and graphics. The handle, dial ring and graphics for all other finish colors are gold-colored.

AVAILABLE FINISHES					
Hunter Green Metallic	Gloss Black	Black Cherry	Sand Metallic	Silver Metallic	Primer Black

**MADE IN USA**

### DIMENSIONS

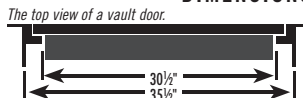

UNIVERSAL VAULT DOOR  
COLOR SHOWN: HUNTER GREEN METALLIC

Shown with Whitetail Buck/Doe scene



Internal Lock Release

## SECURITY DOOR

### BUILT-IN CONCEALMENT AND SECURITY

The Browning ProSteel Security Door has taken in-home security to a new level. With the appearance of a standard residential door, the Security Door is the perfect option for the consumer who prefers to be more discreet about the presence and location of valuables. The Security Door includes a UL® Listed S & G® Type I Electronic Lock with a keypad that can be mounted and concealed up to seven feet from the vault to further hide the true nature of the door. The Security Door features a six-panel door style to help blend in with other residential doors and can be painted to match. The minimum rough door opening for the Security Door is 83" x 36".

### SECURITY DOOR FEATURES

- 17⁄8" thick Duo-Formed® type door
- 1¼" chromed locking bolts
- 1" of fire-resistant insulation in the door face
- Residential interior straight brass handle
- UL® Listed S & G® Type I Electronic Lock
- Concealed hinges
- Internal lock release to open the door from within the vault
- Door swings out a full 180° when open

### SECURITY DOOR SPECIFICATIONS

MODEL	WEIGHT	BOLTS	DOOR CONSTRUCTION	SUGGESTED RETAIL
Security Door	500 lbs.	20/10 active	12-gauge/14-gauge	\$3,749.00

AVAILABLE FINISH
White Primer

**MADE IN USA**

### DIMENSIONS

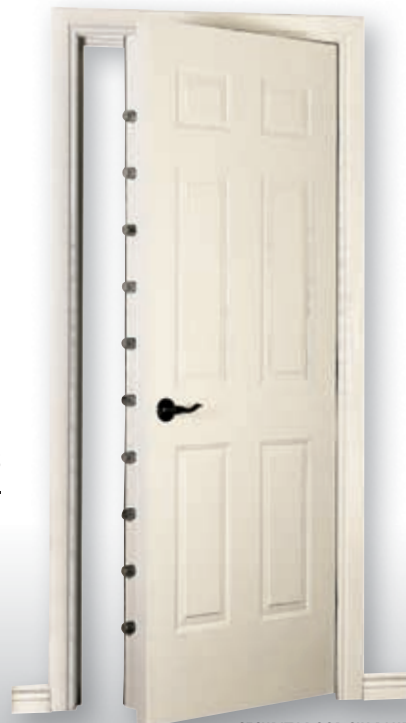

SECURITY DOOR SIX-PANEL



**USER-INSTALLED ACCESSORIES**



**EVERDRY™ ELECTRIC DEHUMIDIFIER**

The EverDry Electric Dehumidifier removes humidity from the interior of a safe and protects against rust. The 18" long EverDry should be used on safes 30" wide and larger. Cord is removable for installation.

Suggested Retail: \$29.95

The safe accessories shown on this page are easily installed by the user. New Browning ProSteel safes are shipped pre-drilled with a molded fire-resistant electrical pass-through sleeve installed in the safe to accommodate the power cord for a light kit or dehumidifier.



**FLEXIBLE EVERDRY™ ELECTRIC DEHUMIDIFIER**

The Flexible EverDry is flat and easily bends to take up less space and makes installation easier, especially in small safes. Removes humidity from the interior of a safe and protects against rust. Plug is removable for installation. LED indicates unit is operating.

Suggested Retail: \$39.95



**DRY-ZONE**

Absorbs moisture without electricity, and is rechargeable in an oven. It can be reactivated indefinitely. One 500-gram box protects up to 37 cubic feet of enclosed space, about the volume of a standard 30" wide safe.

Suggested Retail: \$19.95



**PISTOL RACK**

Store handguns more efficiently and increase storage space on shelves. Access to handguns is made easier by placing them in an upright position. 4 or 6 capacity gun models available.

Suggested Retail: \$24.95 — 6-Gun  
Suggested Retail: \$18.95 — 4-Gun



**DPX® HANDGUN POUCHES**

Store more handguns in your safe with the versatile DPX Handgun Pouches. These versatile pouches include snap-straps to allow use on the MOLLE System used on the DPX and also hook and loop fasteners for use on carpeted interior surfaces. Set of two. Brown box package. Not intended for use as a holster.

Suggested Retail: \$24.95



**ZERUST® PROTECTANT**

Small capsule emits an invisible vapor that forms a corrosion- and rust-resistant barrier on metal surfaces. Volatile Corrosion Inhibitors (VCIs) have been used for years to protect metal parts in industrial and commercial applications. One capsule protects a standard 30" wide safe for one year.

Suggested Retail: \$7.99



**VCI GUN SOCKS**

Browning's VCI (Vapor Corrosion Inhibitor) Gun Sock seals out moisture. VCI penetrates into the smallest crevices where oils cannot reach, driving out moisture. Provides full protection by forming a vapor enclosure around firearm from muzzle to butt. The VCI Sock, when used in a safe or cabinet, will offer additional protection to all metal items in the enclosed area. One size fits most firearms.

Suggested Retail: \$14.95



**FACTORY-INSTALLED ACCESSORIES**

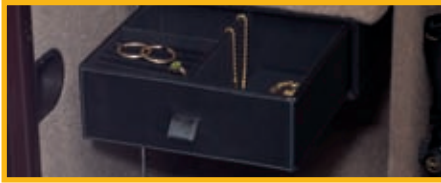

**JEWELRY BOX**

The Jewelry Box option makes storing and finding jewelry inside a safe much easier and convenient. The elegant Jewelry Box conveniently holds jewelry and small items inside the safe in an organized, protected manner. Exterior is synthetic leather; interior is lined with jeweler's velvet. Mounted on half shelf below gun rack on most safe models.

Optional on Gold®, Medallion® and Silver® Series safes.

Standard on Platinum® Plus Series safes.

Factory installed only.

Suggested Retail: \$59.95

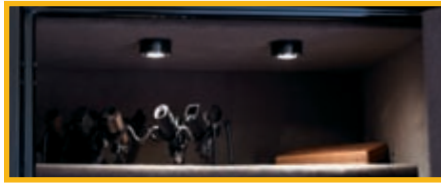

**MEDALLION/SILVER SERIES LIGHT PACKAGE OPTION**

This integrated lighting package makes locating objects on shelves or identifying the right firearm convenient and easy. The two included light modules are wired to a door activated switch and illuminate when the door is opened. Factory installation adds a seamless look with no exposed wiring.

Optional on Medallion and Silver Series safes.

Standard on Platinum Plus and Gold Series safes.

Factory installed only.

Suggested Retail: \$129.00



**MEDALLION/SILVER SERIES MIRROR OPTION**

Located on the top half of the back wall, the mirror option looks great and brightens the interior of the safe to make objects, especially those on the rear of the shelves, easier to find. Constructed of break-resistant material for durability.

Optional on Medallion and Silver Series safes.

Standard on Platinum Plus (full length) and Gold Series safes.

Factory installed only.

Regular (Fits 28 or 26 cubic foot models)  
Suggested Retail: \$49.00

Wide (Fits 39 or 35 cubic foot models)  
Suggested Retail: \$59.00

Wide/Tall (Fits 56 or 42 cubic foot models)  
Suggested Retail: \$89.00



**FILE HANGER**

The file hanger attaches easily to the side of any shelf allowing you to store documents. Can even be mounted above gun storage to take advantage of unused space. Includes one file hanger and 2 box-bottom hanging file folders.

Suggested Retail: \$19.95

**LOCK OPTIONS**

The locks below are available as factory-installed options. Availability by series is described in the information for each lock.



**S & G® ELECTRONIC LOCK**

The S & G Electronic Lock is an advanced security system manufactured by the leader in the lock industry. Includes many technical security features.

Available on all models.



**SECURAM BIOMETRIC LOCK**

The SecuRam Biometric Lock uses the uniqueness of an individual fingerprint as the combination in this advanced security solution. The lock opens with either a fingerprint or a multi-digit code. It is highly secure and operates very quickly. Simple programming instructions. LCD Screen.

Not available on TheftGard, Bronze, Compact, Tactical Series safes and the Security Door.

**INTERIOR OPTIONS**



**ALL SHELF INTERIOR**

The All Shelf Interior adds extra shelves so that the entire interior portion of the safe can be used for small items on the shelves. The long gun rack from the DPX® remains on the door, so some long gun storage remains even when the interior is all shelves. **The All Shelf Interior is available only as a factory-installed option on Gold, Medallion and Silver Series safes.**

Suggested Retail: \$65.00



**DPX® MOSSY OAK® BREAK-UP® CAMO**

If your favorite color is camo, then you will love the Mossy Oak Break-Up DPX Storage System. With a background of Break-Up and complementary color pouch and strap materials, the Camo DPX is an outdoor lover's dream. Available only to replace the DPX Storage System used standard on Platinum Plus, Gold, Medallion and Silver Series models. (Not available on Bronze, Tactical or Select.)

Suggested Retail: \$49.00

FOR AXIS™ ADJUSTABLE SHELVING, SEE PAGE 90

**GUN SAFE WARRANTY**

ProSteel offers a Gun Safe Warranty equal to the best in the industry. Browning ProSteel safes manufactured after January 1, 2006 include a generous warranty that covers:

- ATTEMPTED BREAK IN • BREAK IN • FIRE •

If a safe has one of these situations and your homeowner's insurance policy does not cover the damage to the safe, ProSteel will repair or replace the safe. Contents are not covered. Shipping costs for new safe, if necessary, are included.

Some restrictions apply. See Safe Owner's Manual or Browning.com for complete warranty information. Workmanship warranty information is included.





# GUN CASES

## GUN CASES INDEX

<b>BOOKS</b>	124
<b>FLOATER CASES</b>	123
<b>FITTED PRESENTATION CASES</b>	
Canvas Over/Under	119
Crazy Horse Distressed Leather	116
High Grade Canvas/Crazy Horse Leather	116
John M. Browning Signature	115
Leather/Canvas Series	117
Leather/Canvas Motor Case	117
Santa Fe Waxed Canvas	116
Sporter	119
Traditional	118
Wild Boar	117
<b>FLEXIBLE CASES</b>	
Bear River Floater	123
Birch Creek	121
Cimmaron	122
Flex Foam Buck Mark Pistol	124
Plainsman	122
Santa Fe	121
Skimmer	123
Talon	123
Wild Boar	121
<b>GUN SLIPS, Plainsman</b>	122
<b>GUN SOCKS, VCI</b>	124
<b>MOLDED CASES</b>	
Mirage	120
Bruiser	120
<b>TALON ALUMINUM CASES</b>	119

### FITTED PRESENTATION CASE CLASSIFICATION KEY

			34"	32"+				
Stock/Receiver Capacity	Barrel Capacity	Indicates Bore and Gauge Designation	Indicates Maximum Barrel Length in Inches	Barrels Will Fit with Extended Choke Tubes Installed	Case Holds BT Style Guns	Case Holds Auto/Pump Style Guns	Case Holds Over/Under Style Guns	Rifle Case

## JOHN M. BROWNING SIGNATURE LEATHER CASE



*John M. Browning*

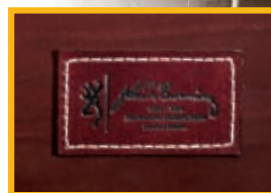

**SHELL** - Solid wood frame · Top grain aniline dyed latigo leather cover with John M. Browning signature patch · Leather security straps with brass buckles

**PADDING TYPE** - Wool-lined interior with removable support blocks to adjust fit

**HINGE** - Three solid brass hinges

**LATCH** - Two brass combination locks

**SPECIAL FEATURES** - Thick leather handle and leather corner accents · Accessory compartment with magnetized choke tube holders · Leather luggage tag

32"+

DESCRIPTION	COLOR	DIMENSIONS	CODE #/UPC #	SUGG. RETAIL
John M. Browning Signature Leather Case	Cherry	35 1/4" x 9 3/4" x 4 1/2"	1428786208 023614202813	\$549.95



**CRAZY HORSE DISTRESSED LEATHER UNIVERSAL CASE**

**SHELL** - Solid wood frame covered with durable Crazy Horse distressed leather

**PADDING TYPE** - Plush wool interior with removable support blocks to adjust fit

**HINGE** - Full-length leather hinge

**LATCH** - Two brass combination locks

**SPECIAL FEATURES** - Thick leather handle and leather end caps · Accessory compartment with six choke tube slots



DESCRIPTION	COLOR	DIMENSIONS	CODE #/UPC #	SUGG. RETAIL
Crazy Horse Distressed Leather Universal Case	Brown	36 $\frac{3}{8}$ " x 10 $\frac{3}{8}$ " x 4"	1424208408 023614013792	\$524.95

**SANTA FE WAXED CANVAS WITH CRAZY HORSE LEATHER TRIM UNIVERSAL CASE**



**SHELL** - Solid wood frame · Covered with Repel-Tex™ waxed canvas with durable Crazy Horse leather trim

**PADDING TYPE** - Synthetic suede interior with removable support blocks to adjust fit

**HINGE** - Three solid brass hinges

**LATCH** - Two brass combination locks

**SPECIAL FEATURES** - Thick leather handle and leather end caps · Buckmark logo stamped on leather patches on the inside and outside · Accessory compartment



DESCRIPTION	COLOR	DIMENSIONS	CODE #/UPC #	SUGG. RETAIL
Santa Fe Waxed Canvas with Crazy Horse Leather Trim Case	Brown	36 $\frac{3}{8}$ " x 10 $\frac{3}{8}$ " x 4 $\frac{3}{8}$ "	1429908408 023614015611	\$459.95

**HIGH GRADE CANVAS/CRAZY HORSE LEATHER UNIVERSAL CASE**



**SHELL** - Solid wood frame · Canvas covered with heavy high-grade leather on borders · Handle and fastening straps

**PADDING TYPE** - Soft wool lining

**HINGE** - Three solid brass hinges

**LATCH** - Two solid brass combination locks

**SPECIAL FEATURES** - Polished brass fittings · Buckmark logo stamped on leather patches on the inside and outside · Leather trim · Accessory compartment



DESCRIPTION	COLOR	DIMENSIONS	CODE #/UPC #	SUGG. RETAIL
High-Grade Canvas/Crazy Horse Leather Trim Case	Sage/Tan	36 $\frac{3}{8}$ " x 10 $\frac{3}{8}$ " x 4"	1424504408 023614013778	\$359.95



**LEATHER/CANVAS UNIVERSAL CASES**



Charcoal/Brown



Brown/Brown



Charcoal/Brown

**SHELL** - Solid wood frame · Canvas covered · Full-grain reinforced leather trim

**PADDING TYPE** - Soft wool lining with movable padded support blocks

**HINGE** - Three solid brass hinges

**LATCH** - Two brass combination locks and adjustable leather straps

**SPECIAL FEATURES** - Embroidered Browning logo inside lid · Buckmark logo stamped on leather patch outside



DESCRIPTION	COLOR	DIMENSIONS	CODE #	UPC #	SUGG. RETAIL
Leather/Canvas Case (Except BT-100)	Charcoal/Brown	36¾" x 10½" x 4¾"	1426129408	023614013785	\$319.95
Leather/Canvas Case (Except BT-100)	Brown/Brown	36¾" x 10½" x 4¾"	1426127408	023614017042	319.95

**LEATHER/CANVAS MOTOR CASE**



**SHELL** - Solid wood frame covered with durable cotton canvas and dark Crazy Horse distressed leather

**PADDING TYPE** - Plush wool interior with removable support blocks to adjust fit

**HINGE** - Three brass hinges

**LATCH** - Two brass combination locks

**SPECIAL FEATURES** - Shotgun stores vertically in case · Thick leather handle and leather corner caps · Accessory compartment



DESCRIPTION	COLOR	DIMENSIONS	CODE #	UPC #	SUGG. RETAIL
Leather/Canvas Motor Case	Olive	35" x 7½" x 4½"	1425204412	023614019060	\$259.95

**WILD BOAR CASE**



**SHELL** - Solid wood frame · Textured synthetic pigskin · Synthetic leather trim

**PADDING TYPE** - Soft microsuede lining with movable high-density foam support blocks

**HINGE** - Four hidden antique brass-plated hinges

**LATCH** - Three antique brass-plated latches

**SPECIAL FEATURES** - Magnetic-hold choke tube compartment · Antique brass-plated corner guards

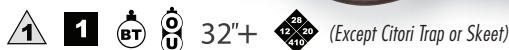

DESCRIPTION	COLOR	DIMENSIONS	CODE #	UPC #	SUGG. RETAIL
Wild Boar Case	Sage/Brown	34" x 10½" x 3¾"	1421044212	023614204497	\$259.95

*This case will not hold titanium choke tubes*



TRADITIONAL CASES



AVAILABLE COLORS:



AVAILABLE INTERIORS:



There is no better way to protect and transport your firearm than within a fitted gun case. These handsome cases are available in a variety of styles and feature rugged construction, water-repellent coatings, brass corner accents, deep pile fleece linings, rigid framing, secure locks and comfortable handles. Some cases even include accessory compartments for small items such as choke tubes. Most cases have moveable padded blocks that can be customized to precisely fit your firearm. Show your appreciation for your firearm with a Browning fitted case.

- SHELL** - Rugged wood construction covered with expanded vinyl
- PADDING TYPE** - Deep pile fleece with fabric-covered positioning blocks
- HINGES** - Three brass-plated hinges
- LATCH** - One or two key locks
- SPECIAL FEATURES** - Brass corner accents · Folding handle · Accessory compartment

DESCRIPTION	CLASSIFICATION		COLOR	DIMENSIONS	CODE #/UPC #	SUGG. RETAIL
1 ▶ Traditional BT-Style Single Barrel Trap Case	1	1 BT	Classic Brown	35½" x 8¾" x 3¾"	142810 023614566915	\$274.95
Traditional BT-Style Single Barrel Trap Case (not shown)	1	1 BT	Black/Tan	35½" x 8¾" x 3¾"	1428119410 023614013822	274.95
2 ▶ Traditional Auto/Pump Shotgun Case (Except Maxus)	1	2 2/3	Classic Brown	35½" x 10½" x 3¾"	142820 023614030973	299.95
Traditional Universal O/U, BT Trap Case (not shown)	1	1 BT	Classic Brown	35½" x 9" x 3½"	1428118408 023614013839	274.95
3 ▶ Traditional Universal O/U, BT Trap Case	1	1 BT	Black/Tan	35½" x 9" x 3½"	1428119408 023614013815	274.95
Traditional O/U Shotgun Case (Except Citori Trap or Skeet) (not shown)	1	1	Classic Brown	33" x 8⅝" x 3"	142841 023614031048	274.95
Traditional O/U Shotgun Case (Except Citori Trap or Skeet) (not shown)	1	1	Classic Brown	31" x 8⅝" x 3"	142840 023614030997	239.95
Traditional O/U Shotgun Case for Citori Trap or Skeet (not shown)	1	1	Classic Brown	33¼" x 8¾" x 4⅝"	142880 023614239819	274.95
Traditional O/U w/ Extra Barrel Case (Except Citori Trap or Skeet) (not shown)	1	2	Classic Brown	31" x 10⅝" x 3¾"	142850 023614031017	274.95
Traditional Two Gun Case (not shown)	2	2	Classic Brown	36" x 8¾" x 5⅝"	142890 023614244790	349.95
4 ▶ Traditional Browning Semi-Automatic 22 Rifle Case	1	1 R	Black/Tan	27¼" x 9" x 3¼"	1428608090 023614015628	274.95



**CANVAS OVER/UNDER CASE**

**SHELL** - Solid wood frame covered with canvas  
**PADDING TYPE** - Soft wool lining  
**HINGE** - Three brass hinges  
**LATCH** - Two brass combination locks  
**SPECIAL FEATURES** - Leather corner accents · Thick leather handle · Leather Browning logo



DESCRIPTION	COLOR	DIMENSIONS	CODE #/UPC #	SUGG. RETAIL
Canvas Over/Under Case (Except Citori XS Skeet and Trap)	Green/Olive	34 $\frac{3}{8}$ " x 9 $\frac{5}{8}$ " x 3 $\frac{1}{16}$ "	142510 023614031277	\$229.95

**SPORTER CASE**

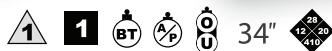

DESCRIPTION	COLOR	DIMENSIONS	CODE #/UPC #	SUGG. RETAIL
Sporter Case	Black/Gold	36 $\frac{1}{4}$ " x 11" x 3 $\frac{3}{4}$ "	1422109408 023614019114	\$199.95

**SHELL** - Solid wood frame with PVC-coated exterior  
**PADDING TYPE** - High-density convoluted foam  
**HINGE** - Full-length leather hinge  
**LATCH** - Two combination locks  
**SPECIAL FEATURES** - Interior tie-down straps

**TALON ALUMINUM FRAME CASES**



**SHELL** - Anodized aluminum frame · Diamond pattern ABS cover over composite panels  
**PADDING TYPE** - High-density foam padding · Straps to hold firearms in place on double and takedown models  
**CLOSURE** - Combination and key locks  
**SPECIAL FEATURES** - Locking ammunition storage case · Wheels on double and takedown models · Embossed metal Buckmark plaque · Lightweight

DESCRIPTION	DIMENSIONS	WEIGHT	CODE #	UPC #	SUGG. RETAIL
Double Gun	53" x 16" x 5"	17 lbs.	1460079999	023614204527	\$259.95
Takedown	35 $\frac{1}{2}$ " x 10 $\frac{1}{2}$ " x 4"	9 lbs.	1460079512	023614204534	149.95
Double Pistol	13 $\frac{1}{2}$ " x 12" x 3 $\frac{3}{4}$ "	4.3 lbs.	1460079866	023614204558	74.95
Ammo Case	15 $\frac{1}{2}$ " x 6" x 6"	4.7 lbs.	12100798	023614204572	79.95



**BRUISER CASES**

Bruiser gun cases offer exceptional protection for your valuable firearms during airline travel and transportation. The high-density, double wall polyethylene construction makes this case one tough "Bruiser." For added protection, foam inserts can be extended outward to keep guns separated or pushed inward if not needed.

An O-ring sealed tongue and groove lid provides excellent weather resistance. Recessed wheels offer easy mobility. Corrosion-inhibiting Zerust® inserts are added to each case to help protect your firearms from rust. Bruiser gun cases are offered in double gun and single takedown models.



Foam inserts protect guns from each other

Zerust insert protects all metal surfaces from rust

Recessed wheels

Purge valve



Double Gun

Single Takedown

- SHELL** - Double wall high-density polyethylene with diamond plate texturing
- PADDING TYPE** - High-density foam with extendable foam insert barriers
- HINGE** - Tough Lock™
- LATCH** - Three locking points for padlocks
- SPECIAL FEATURES** - Rounded corners · Recessed handles · Purge valve · Tongue and groove lid with O-ring seal · Corrosion-inhibiting Zerust® inserts · Recessed wheels · Airline approved · Available in double gun or single takedown models



DESCRIPTION	INSIDE DIMENSIONS	WEIGHT	CODE #	UPC #	SUGG. RETAIL
Double Gun	54" x 15" x 5"	24 lbs.	149002	023614200338	\$199.95
Single Takedown	38" x 14" x 5"	16 lbs.	149001	023614200321	139.95

**MIRAGE CASES**



Single Gun

Double Gun



- SHELL** - Copolymer material
- PADDING TYPE** - Double convoluted foam
- HINGE** - Piano-style hinges
- LATCH** - Four locking points
- SPECIAL FEATURES** - Single gun holds one scoped firearm · Oversize double case holds two scoped firearms · Airline approved · Corrosion-inhibiting Zerust® inserts

DESCRIPTION	INSIDE DIMENSIONS	WEIGHT	CODE #	UPC #	SUGG. RETAIL
Double Gun	53 3/8" x 16 1/2" x 4 1/2"	12 lbs.	1470021	023614183518	\$69.95
Single Gun	53 3/8" x 12 3/4" x 3 3/4"	5 lbs.	1470022	023614013921	49.95



**BIRCH CREEK CASES**

**NEW**



**SHELL** - Heavy cotton canvas  
**LINING** - Brushed tricot  
**PADDING TYPE** - High-density open cell foam  
**CLOSURE** - Full-length zipper with SnapTab closure allows the case to lay flat when open  
**MUZZLE CAP** - Simulated leather  
**TRIM & BINDING** - Simulated leather  
 · Embossed Buckmark

DESCRIPTION	SIZE	CODE #	UPC #	SUGG. RETAIL
<b>NEW</b> Olive Scoped	48"	1411063248	023614365266	\$59.95
<b>NEW</b> Olive Regular	52"	1411063152	023614365273	59.95
<b>NEW</b> Brown/Pink Scoped	48"	1411068248	023614365280	59.95
<b>NEW</b> Brown/Pink Regular	52"	1411068152	023614365297	59.95

**WILD BOAR CASES**



**SHELL** - Textured synthetic pigskin with synthetic leather trim  
**LINING** - Brushed tricot  
**PADDING TYPE** - High-density open cell foam  
**CLOSURE** - Zipper with SnapTab closure  
**COLOR** - Green/brown  
**TRIM & BINDING** - Synthetic leather · Full-zip design allows case to lie flat when opened

DESCRIPTION	SIZE	CODE #	UPC #	SUGG. RETAIL
Scoped	48"	1411044248	023614205241	\$64.95
RMEF Scoped	48"	141104424R	023614205258	64.95
Regular	52"	1411044152	023614205265	64.95
Pistol Rug	13"	1431044813	023614205272	19.95

**SANTA FE CASES**



**SHELL** - Waxed 10 oz. cotton canvas  
**LINING** - Quilted flannel  
**PADDING TYPE** - Cotton batting  
**CLOSURE** - Zipper  
**COLOR** - Field tan

**MUZZLE CAP** - Leather  
**TRIM & BINDING** - Crazy Horse leather  
 · Adjustable leather strap · Side pocket with choke tube loops on 52" model  
 · Shell loops on 48" model · Hook and loop closure

DESCRIPTION	SIZE	CODE #	UPC #	SUGG. RETAIL
Regular	52"	1419908152	023614015642	\$159.95
Scoped	48"	1419908248	023614015635	169.95
Pistol Rug	11"	143990811	023614015666	49.95





**CIMMARON CASES**

**NEW**

**NEW**



Scoped, Mossy Oak® Break-Up® Infinity™

Regular, Mossy Oak® Break-Up® Infinity™



Scoped

Pistol Rug

Regular

**SHELL** - 600 denier polyester canvas  
**LINING** - Brushed tricot  
**PADDING TYPE** - Open-cell foam  
**CLOSURE** - Zipper  
**TRIM & BINDING** - Polyester canvas  
 · Outside pocket for choke tubes on 52" model · Pocket with shell loops on 48" model  
**MUZZLE CAP** - Leather



BLR® Takedown

DESCRIPTION	SIZE	CODE #	UPC #	SUGG. RETAIL
<b>NEW</b> MOINF Scoped	48"	1410300248	023614365303	\$49.95
<b>NEW</b> MOINF Regular	52"	1410300152	023614365310	49.95
Scoped	40"	1410309240	023614018216	44.95
Scoped	44"	1410309244	023614015086	44.95
Scoped	48"	1410309248	023614013464	44.95
Regular	52"	1410309152	023614013617	44.95
Pistol Rug	11"	1430309111	023614013853	17.45
Pistol Rug	13"	143030913	023614013860	17.45
BLR Takedown	—	1410309090	023614017097	49.95

**PLAINSMAN CASES**

13" Pistol Rug, Mossy Oak® Break-Up® Infinity™



Scoped, Mossy Oak® Break-Up® Infinity™



Regular, Black



Slip, Olive

**SHELL** - 600 denier polyester canvas  
**LINING** - Brushed tricot  
**PADDING TYPE** - Open-cell foam  
**CLOSURE** - Zipper  
**TRIM & BINDING** - Polyester canvas

11" Pistol Rug, Olive

DESCRIPTION	SIZE	CODE #	UPC #	SUGG. RETAIL	DESCRIPTION	SIZE	CODE #	UPC #	SUGG. RETAIL
<b>NEW</b> Black Scoped	40"	1410049240	023614365334	\$29.95	Olive Slip	52"	1410044052	023614204992	\$27.95
<b>NEW</b> Black Scoped	44"	1410049244	023614365341	29.95	Olive Pistol Rug	11"	1430044811	023614205036	17.95
Black Scoped	48"	1410049248	023614204596	29.95	Olive Pistol Rug	13"	1430044813	023614205159	17.95
Black Regular	52"	1410049152	023614204602	29.95	MOINF Regular	52"	1410040152	023614210948	39.95
Black Slip	52"	1410049052	023614204619	27.95	MOINF Scoped	48"	1410040248	023614210931	39.95
Black Pistol Rug	13"	1430049813	023614204671	17.95	MOINF Scoped	50"	1410040250	023614210962	49.95
Olive Scoped	48"	1410044248	023614204978	29.95	MOINF Slip	52"	1410040052	023614210955	37.95
Olive Regular	52"	1410044152	023614204985	29.95	MOINF Pistol Rug	13"	1430040813	023614210986	19.95



**TALON CASE WITH BUCKMARK**



**SHELL** - 600 denier poly canvas  
**LINING** - Brushed tricot  
**PADDING TYPE** - Open and closed cell foam  
**CLOSURE** - Zipper  
**COLOR** - Black  
**TRIM & BINDING** - Polyester canvas  
 · 3D Buckmark embroidery · Oversize design fits large optics and bipods  
 · Two zipper closure pockets

DESCRIPTION	SIZE	CODE #	UPC #	SUGG. RETAIL
Black	50" Oversized	1410079250	023614205234	\$49.95

**SKIMMER ZIPPER FLOATER CASE**

**NEW**

Mossy Oak® Duck Blind®

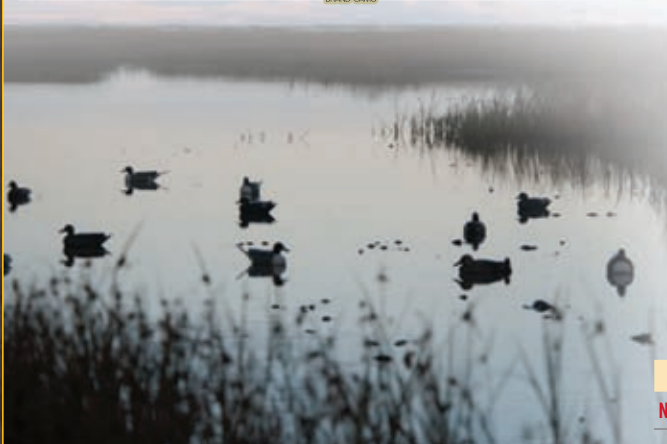

**SHELL** - Polyester canvas  
**LINING** - Nylon tricot  
**PADDING TYPE** - High-density closed cell foam  
**CLOSURE** - Zipper side closure allows easy drying · Hook and loop flap  
**TRIM & BINDING** - Side pocket

DESCRIPTION	SIZE	CODE #	UPC #	SUGG. RETAIL
<b>NEW</b> MODB	52"	1410522152	023614365327	\$44.95

**BEAR RIVER FLOATER CASES**

Field Tan



Mossy Oak® Duck Blind®



**SHELL** - 600 denier polyester  
**LINING** - Nylon  
**PADDING TYPE** - Closed-cell foam  
**CLOSURE** - Hook and loop flap  
**TRIM & BINDING** - Polyester

DESCRIPTION	SIZE	CODE #	UPC #	SUGG. RETAIL
Field Tan	52"	1410518052	023614205289	\$29.95
MODB	52"	1410512152	023614013846	39.95



**FLEX FOAM BUCK MARK PISTOL CASE**

**SHELL** - 600 denier polyester  
**LINING** - Laminated nylon tricot  
**PADDING TYPE** - EVA foam  
**CLOSURE** - Zipper  
**COLOR** - Black

**TRIM & BINDING** - Polyester  
 · Nylon · D-rings for attaching shoulder strap (not included)  
**SPECIAL FEATURES** - Case has two cavities for magazines



DESCRIPTION	SIZE	CODE #	UPC #	SUGG. RETAIL
Pistol Case	15"	1419001	023614015659	\$59.95

**VCI GUN SOCKS**



VCI (Vapor Corrosion Inhibitor) Gun Sock

Two-piece VCI Gun Sock

**CLOSURE** - Drawstring

The VCI (Vapor Corrosion Inhibitor) Gun Sock seals out moisture. VCI penetrates into the smallest crevices where oils cannot reach, to drive out moisture. Provides full protection by forming a vapor enclosure around firearm from muzzle to butt. The VCI Sock, when used in a gun safe or cabinet, will offer additional protection to all metal items in the enclosed area. One size fits most firearms.

DESCRIPTION	SIZE	CODE #	UPC #	SUGG. RETAIL
VCI Gun Sock	One size	149985	023614204282	\$14.95
VCI Gun Sock	Two-Piece	149986	023614019077	14.95

**BOOKS**

**JOHN M. BROWNING BIOGRAPHY**

The essential biography detailing the life and inventions of the greatest firearms inventor the world has ever known  
 · Includes detailed original patent drawings and photographs  
 · Hardcover · 390 pages

NUMBER	DESCRIPTION	SUGG. RETAIL
12980	John M. Browning Biography	\$37.95

**ARS MECHANICA HISTORY**

The ultimate history of Fabrique Nationale, one of the world's greatest gunmakers · Illustrated with hundreds of photos, illustrations and technical drawings of FN, Browning, Winchester guns and other products, many never before published · Makes the perfect gift · Hardcover · 576 pages

NUMBER	DESCRIPTION	SUGG. RETAIL
12981	Ars Mechanica Book	\$99.95

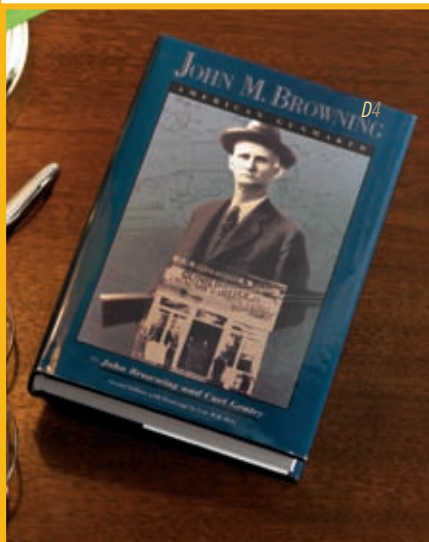



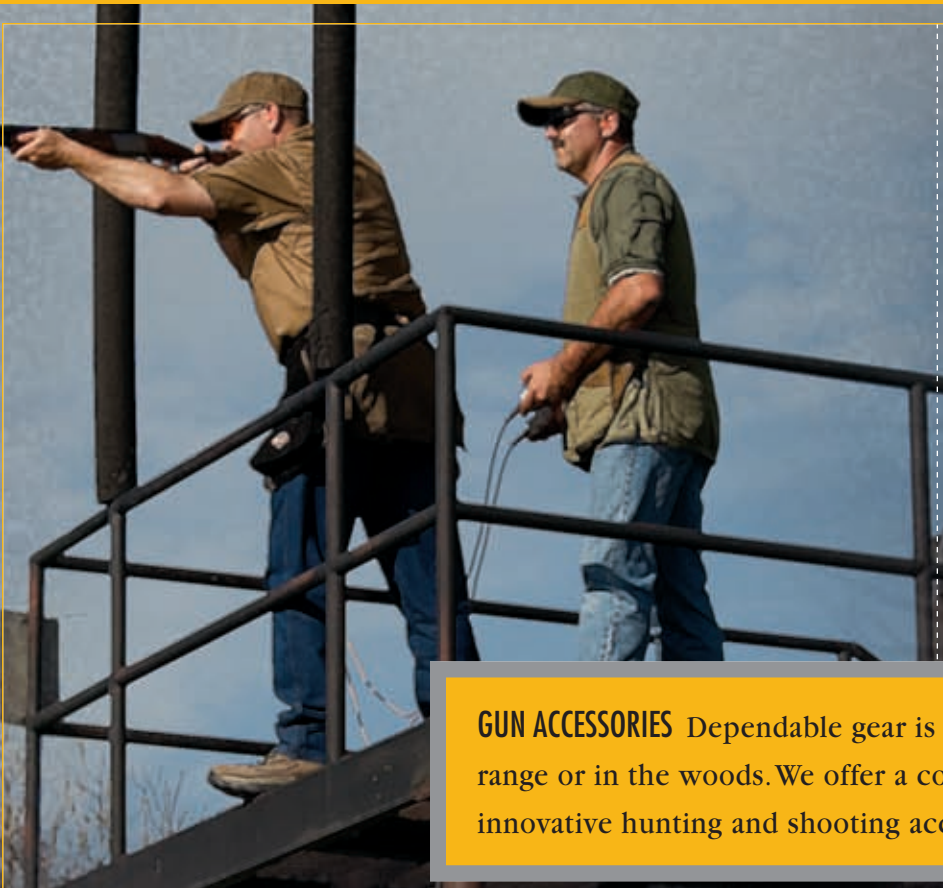

**GUN ACCESSORIES INDEX**

<b>BAGS</b>	
Shooting	125-127
Hunting	128-129
<b>CARTRIDGE CASES</b>	
	143
<b>CHOKE TUBES</b>	
Flush Tubes	146
Extended Tubes	147-149
Specialty Tubes	148-149
Wrenches	146-149
<b>CHOKE TUBE CASES</b>	
	145
<b>CLEANING ACCESSORIES</b>	
	153
<b>COMBO KITS</b>	
	144
<b>HEARING PROTECTION</b>	
	150-151
<b>HUNTING ACCESSORIES</b>	
	143
<b>MAGAZINES</b>	
	137-139
<b>MOA SHOOTING STICKS</b>	
	135
<b>RIMFIRE PISTOL ACCESSORIES</b>	
	140-142
<b>SCOPE RINGS AND BASES</b>	
	136-137
<b>SHOOTING GLASSES</b>	
	152
<b>SIGHTS</b>	
	142, 145
<b>SLINGS</b>	
Synthetic Slings	130-132
Leather Slings	132-133
Gunslinger	134
<b>SNAP CAPS</b>	
	149

**GUN ACCESSORIES** Dependable gear is essential for a successful day at the range or in the woods. We offer a comprehensive line of high-quality, innovative hunting and shooting accessories for every endeavor.

# GUN ACCESSORIES

**BIRCH CREEK SHOOTING BAGS** **NEW**



Pistol pockets

- 1 ▶ BIRCH CREEK TWO PISTOL RANGE BAG**
  - Heavy cotton canvas outer with simulated leather trim
  - Two padded, zippered pistol pockets
  - Double zip closure top for easy access
  - Adjustable padded shoulder strap
  - 12 elasticized interior magazine loops
  - Comfortable simulated leather handle
  - 14" L x 9" H x 9" D
- 2, 4 ▶ BIRCH CREEK COMPACT RANGE BAGS**
  - Heavy cotton canvas outer with simulated leather trim
  - Front accessory pocket
  - Divided interior holds eight boxes of shells
  - Adjustable padded shoulder strap
- 3, 5 ▶ BIRCH CREEK SHELL POUCHES**
  - Heavy cotton canvas outer with simulated leather trim
  - Large divided compartment
  - Three choke tube/shell loops
  - Adjustable belt with speed buckle

DESCRIPTION	CODE #	UPC #	SUGG. RETAIL
1 ▶ <b>NEW</b> Two Pistol Range Bag	121106849	023614365358	\$49.95
2 ▶ <b>NEW</b> Compact Range Bag, Olive	121106841	023614365365	29.95
3 ▶ <b>NEW</b> Shell Pouch, Olive	121106843	023614365372	19.95
4 ▶ <b>NEW</b> Compact Range Bag, Pink	121106511	023614365389	29.95
5 ▶ <b>NEW</b> Shell Pouch, Pink	121106513	023614365396	19.95





**CLAYMASTER™ SERIES BAGS**



Shells not included with bags

**1 ▶ CLAYMASTER SHOOTING BAG**

- 600 denier nylon outer
- Padded interior for rigid shape
- Four exterior accessory pockets
- Comfortable padded handles and shoulder strap
- Interior divider
- 11" W x 9" H x 8" D

**2 ▶ CLAYMASTER SHELL POUCH**

- 600 denier nylon outer
- Large double compartment shell pouch
- Shell box holder with choke tube/shell loops
- Adjustable belt with quick-release buckle

**3 ▶ CLAYMASTER BOX SHELL CARRIER**

- Metal clip attaches to belt

**4 ▶ CLAYMASTER EMPTY SHELL CARRIER**

- Attaches to belt · Mesh pouch

DESCRIPTION	CODE #	UPC #	SUGG. RETAIL
1 ▶ Shooting Bag	121020091	023614016946	\$55.95
2 ▶ Shell Pouch	121020093	023614016953	21.95
3 ▶ Box Shell Carrier	121020094	023614016960	9.95
4 ▶ Empty Shell Carrier	121020096	023614016977	11.95

**CIMMARON SERIES BAGS**



Shells not included with bags

**1 ▶ CIMMARON SHOOTING BAG**

- 600 denier nylon outer
- Padded interior for rigid shape
- Four exterior accessory pockets
- Comfortable padded handles and shoulder strap
- Interior divider
- 11½" W x 10" H x 9" D

**2 ▶ CIMMARON SHELL POUCH**

- 600 denier nylon mesh pouch
- Large empty hull pouch
- Shell box holder with choke tube/shell loops
- Adjustable belt with quick-release buckle

**3 ▶ CIMMARON SHELL BOX CARRIER**

- Metal clip attaches to belt

**4 ▶ CIMMARON FOUR BOX SHELL CARRIER**

- Accessory pockets
- Sturdy web handles

DESCRIPTION	CODE #	UPC #	SUGG. RETAIL
1 ▶ Shooting Bag	121030091	023614016915	\$64.95
2 ▶ Shell Pouch	121030093	023614016922	24.95
3 ▶ Shell Box Carrier	121030094	023614016939	11.95
4 ▶ Four Box Carrier	121030095	023614017035	15.95



SANTA FE SERIES BAGS



1 ▶ SANTA FE SHOOTER'S BAG

- Constructed from 10 oz. waxed cotton canvas with Crazy Horse leather trim
- Foam padded sides maintain bag shape
- Large compartmentalized interior holds 16 boxes of shells and allows separation of shell gauges
- Sturdy YKK® zippers
- Four exterior accessory pockets
- Comfortable padded leather shoulder strap and handles
- Attractive brass hardware
- 12" W x 10" H x 9" D

2 ▶ SANTA FE SHELL POUCH

- Constructed from 10 oz. waxed cotton canvas with Crazy Horse leather trim
- Large empty hull pouch
- Shell box holder with choke tube/shell loops
- Adjustable belt with quick-release buckle

3 ▶ SANTA FE SHELL BOX CARRIER

- Constructed from 10 oz. waxed cotton canvas with Crazy Horse leather trim
- Metal clip attaches to belt

DESCRIPTION	CODE #	UPC #	SUGG. RETAIL
1 ▶ Shooter's Bag	121040081	023614016984	\$179.95
2 ▶ Shell Pouch	121040082	023614016991	64.95
3 ▶ Shell Box Carrier	121040084	023614017004	24.95

Shells not included with bags

WILD BOAR SERIES BAGS

1 ▶ WILD BOAR LARGE ROLLER SHOOTING BAG

- Textured synthetic pigskin with synthetic leather trim
- Padded interior for rigid shape
- Side exterior accessory pockets
- ABS roller bearing wheels
- Collapsible handle zips into its own pocket
- Handle extends to 37½"
- 16" W x 15" H x 10" D

2 ▶ WILD BOAR COMPACT SHOOTING BAG

- Textured synthetic pigskin with synthetic leather trim
- Large divided shell compartment
- Front exterior accessory pocket
- Carries eight boxes of shells

3 ▶ WILD BOAR SHELL POUCH

- Textured synthetic pigskin with synthetic leather trim
- Large empty hull pouch
- Shell box holder with choke tube/shell loops
- Adjustable belt with quick-release buckle

1 ▶ Roller Bag, Back



1 ▶ Roller Bag, Front with handle extended



2



3



DESCRIPTION	CODE #	UPC #	SUGG. RETAIL
1 ▶ Large Roller Shooting Bag	121104047	023614205296	\$84.95
2 ▶ Compact Shooting Bag	121104041	023614205302	34.95
3 ▶ Shell Pouch	121104042	023614205319	24.95



**SAWTOOTH MOUNTAIN BAGS**

Sawtooth Mountain bags are built for rugged adventures. From the Ballistic Nylon and heavy-duty 900 denier poly shell fabric, to the oversized zippers, durable molded bottoms and reinforced stress points, these bags are designed to withstand the abuse of traveling to hunting camps with heavy loads. Anvil-style openings on both duffel bags provide a wide mouth to quickly pack or locate clothing, while the separate bottom compartments are perfect for separating dirty boots and other gear. The conveniently-sized Gear Bag is ideal for knives, flashlights and ammo and the zip open top makes everything fast and easy to grab. Each bag has been designed by the famed Fishpond® company to be The Best There Is®.

**LARGE DUFFLE**

- Anvil-style opening
- Cavernous main compartment
- Two huge side compartments
- Two pockets under buckle-down flap
- Large bottom pocket for boots or parkas
- Hidden pocket for a handgun
- Mossy Oak® New Break-Up®
- Dimensions: 26" L x 16" W x 16" D

**MEDIUM DUFFLE**

- Anvil style opening
- Big main compartment
- Two side pockets
- Two pockets under buckle-down flap
- Large bottom compartment for boots or a parka
- Mossy Oak® New Break-Up®
- Dimensions: 18" L x 12" W x 12" D

**GEAR BAG**

- Ideal for ammo, flashlights, knives and other small items
- Slick dual-entry top for quick access to ammo or gear
- Accessory pocket on the end
- Removable dividers to customize interior
- Hard molded bottom
- Mossy Oak® New Break-Up®
- Dimensions: 15" L x 7" W x 7" D



Large Duffle

SAWTOOTH MOUNTAIN



Medium Duffle



Gear Bag

DESCRIPTION	CODE #	UPC #	SUGG. RETAIL
Large Duffle	121805	023614058946	\$149.99
Medium Duffle	121806	023614058953	119.99
Gear Bag	121804	023614058960	79.99





SALT CREEK WATERFOWL BAGS

SALT CREEK  
waterfowl



Large Duffle



Medium Duffle



Gear Bag



Luggage Tag

The Salt Creek meanders through some of the West's finest waterfowl marshes, so it's only fitting that the Browning waterfowl bags that bear its name are the finest on the market. As any duck hunter knows, waterfowl gear must stand up to the harshest conditions. Salt Creek bags are built out of the finest and most rugged materials like wear-resistant Ballistic Nylon, heavy-duty 900 denier poly, rust-proof pewter zipper pulls, oversized heavy-coil zippers, reinforced stitching, rigid foam liners and molded waterproof bottoms. These are just some of the construction features that make these bags the top-of-the-line gear for waterfowl hunting. Couple the durable construction with functional design and handsome aesthetics and it's hard to imagine a better built, better looking, more functional line of waterfowl bags anywhere. Designed and engineered by the famed Fishpond® company, these bags are built with the sole purpose to be the best.

**LARGE DUFFLE**

- Cavernous main compartment
- Large outer lid pocket
- Two end pockets, one rear pocket
- Rigid lid has buckle, zippered and magnetic closures for easy access and protection from the elements
- Shotgun straps and inner and outer pocket on lid
- Hard molded polymer bottom
- Mossy Oak® Duck Blind®
- Dimensions: 25" L x 13" W x 12" D

**MEDIUM DUFFLE**

- Big main compartment
- Two end pockets, one rear pocket
- Rigid lid has buckle, zipper and magnetic closures for easy access and protection from the elements
- Large outer lid pockets
- Hard molded polymer bottom
- Mossy Oak® Duck Blind®
- Dimensions: 20" L x 11" W x 10" D

**GEAR BAG**

- Ideal for the boat or layout blind
- Top and side-entry for quick access to ammo
- Collapsible, zippered dividers separate ammo and customize interior
- External and internal openings to access end shell pockets
- One rear pocket
- Hard molded polymer bottom
- Mossy Oak® Duck Blind®
- Dimensions: 17" L x 9" W x 7" D

**LUGGAGE TAG**

- Durable molded rubber
- Highly visible with Buckmark logo
- Name and address card included

DESCRIPTION	CODE #	UPC #	SUGG. RETAIL
Large Duffle	121905	023614058977	\$199.99
Medium Duffle	121906	023614058984	149.99
Gear Bag	121904	023614058991	89.99
Luggage Tag	12101	023614059073	7.99



**X-CELLERATOR PLUS™/X-CELLERATOR™ SLINGS**



Cartridges shown are not included with slings.

**X-CELLERATOR PLUS SLINGS**

- Padded neoprene shoulder strap
- Easy adjusting, patented slip-lock buckle
- Includes metal swivels

**X-CELLERATOR SLINGS**

- Easy adjusting patented slip-lock buckle
- Can be positioned as shoulder or backpack sling
- Wide range of adjustment
- Includes metal swivels
- 1¼" width

DESCRIPTION	FITS	STUD DISTANCE	CODE #	UPC #	SUGG. RETAIL
<b>X-CELLERATOR PLUS SLINGS</b>					
<b>NEW</b> Mossy Oak Break-Up Infinity	Rifles	25½" to 28"	122300725	023614059929	\$39.99
Digital Green	Rifles	25½" to 28"	122313425	023614059042	39.99
Black	Rifles	25½" to 28"	122312025	023614570325	39.99
Mossy Oak New Break-Up	Rifles	25½" to 28"	122310125	023614570332	39.99
Mossy Oak Brush	Rifles	25½" to 28"	122311625	023614038030	39.99
Black	Shotguns	38" to 48"	122312035	023614570349	44.99
Mossy Oak New Break-Up	Shotguns	38" to 48"	122310135	023614570356	44.99
Mossy Oak Duck Blind	Shotguns	38" to 48"	122313035	023614047513	44.99
<b>X-CELLERATOR PLUS SLINGS WITH CARTRIDGE LOOPS</b>					
Black	Rifles	25½" to 28"	122302325	023614201809	\$49.99
Mossy Oak New Break-Up	Rifles	25½" to 28"	122310325	023614201793	49.99
<b>X-CELLERATOR SLINGS</b>					
<b>NEW</b> Mossy Oak Break-Up Infinity	Rifles	25½" to 28"	122310725	023614059943	\$29.99
Digital Green	Rifles	25½" to 28"	122303425	023614059059	29.99
Black	Rifles	25½" to 28"	122302025	023614806714	29.99
Tan	Rifles	25½" to 28"	122301425	023614806738	29.99
Mossy Oak New Break-Up	Rifles	25½" to 28"	122300125	023614806745	29.99
Mossy Oak Brush	Rifles	25½" to 28"	122301625	023614038047	29.99
Black	Most Pumps and Autos	29¾" to 48¼"	122302029	023614806752	29.99
Mossy Oak New Break-Up	Most Pumps and Autos	29¾" to 48¼"	122300129	023614806769	34.99
Mossy Oak Duck Blind	Most Pumps and Autos	29¾" to 48¼"	122303035	023614047506	34.99



**ECLIPSE SLINGS**



- Padded neoprene shoulder strap
- Easy adjust patented buckle
- Convenient thumb loop gives your arm a rest
- Heavy denier polyester with neoprene padding
- Select Black or Mossy Oak® New Break-Up®
- Includes metal swivels

DESCRIPTION	FITS	STUD DIST.	CODE #	UPC #	SUGG. RETAIL
Black	Rifles	25½" to 28"	122320025	023614182146	\$39.99
Mossy Oak New Break-Up	Rifles	25½" to 28"	122320125	023614182139	39.99



NEOPRENE SLINGS



DESCRIPTION	FITS	STUD DIST.	CODE #	UPC #	SUGG. RETAIL
<b>NEW</b> Black	Rifles	Adjustable	12201316	023614369950	\$29.99
MONBU	Rifles	Adjustable	12201318	023614063513	29.99
MODB	Shotguns	Adjustable	12201317	023614063506	29.99

· Shock-absorbing 6mm neoprene offers superior comfort

· Rubberized backing is textured for a positive, non-slip grip  
 · Ladder buckle for easy adjustment  
 · Metal swivels

FLEX FOAM™ AND FLEX GRIP™ SLINGS

FLEX GRIP SWIFTACH

- Molded rubberized pad won't slip off shoulder
- Rubberized pad allows for stretch and comfort
- Attaches under magazine cap, neoprene sleeve slips over buttstock
- Shell loops
- Quick release design



Flex Grip Swiftach



Flex Foam Sporter, Black



Flex Foam Sporter, Mossy Oak® New Break-Up®



Flex Foam Sporter, Mossy Oak® Duck Blind®



Flex Grip Sling, Black



Flex Grip Sling, Brown

FLEX FOAM SPORTER

- Waterproof, extra-thick molded foam provides the ultimate in comfort
- Back side is textured for a positive, non-slip grip
- Includes metal sling swivels
- Available in Black, Mossy Oak® New Break-Up® or Mossy Oak® Duck Blind®

FLEX GRIP

- Molded rubberized pad won't slip off shoulder
- Rubberized pad allows for stretch and comfort
- Adjustable length
- Back side is textured for a positive, non-slip grip
- Three shell loops
- Includes metal sling swivels
- Available in black with rifle cartridge loops or brown with shotgun shell loops

DESCRIPTION	FITS	STUD DIST.	CODE #	UPC #	SUGG. RETAIL
<b>NEW</b> Flex Grip Swiftach	Most Shotguns	Adjustable	1226720	023614369974	\$49.99
Flex Foam Sporter, Black	Most Rifles	Adjustable	12230	023614058687	19.99
<b>NEW</b> Flex Foam Sporter, Mossy Oak New Break-Up	Most Rifles	Adjustable	12231	023614059264	24.99
<b>NEW</b> Flex Foam Sporter, Mossy Oak Duck Blind	Most Rifles	Adjustable	12232	023614369981	24.99
Flex Grip Sling, Black	Most Rifles	Adjustable	1226799	023614063537	34.99
<b>NEW</b> Flex Grip Sling, Brown	Most Rifles	Adjustable	1226717	023614369967	34.99



**CONTOUR CLINCHER SLINGS**

**DURA-TOUCH®**  
Armor Coating

*Contour Clincher, Black*



*Contour Clincher, Green Camo*



**CONTOUR CLINCHER**

- Quiet Dura-Touch® Armor Coating improves grip in all conditions
- Has comfort contour fit
- Won't slide or roll off shoulder
- Includes metal sling swivels
- Resists cracking and fading

DESCRIPTION	FITS	STUD DIST.	CODE #	UPC #	SUGG. RETAIL
Black	Rifles and Shotguns	Adjustable	122920	023614058670	\$34.99
Green Camo	Rifles and Shotguns	Adjustable	12294009	023614058694	34.99

**HORSEHAIR SLINGS**

*Timber*



*Royal*



*Black*



*Driftwood*



*Timber Royal Black Driftwood*

- Attractive colors and patterns
- Braided horsehair is stylish, comfortable and strong
- Features all-leather reinforcement and a thumb loop
- One size fits most rifles and shotguns
- Swivels not included

DESCRIPTION	CODE #	UPC #	SUGG. RETAIL
Timber	122294	023614063872	\$59.99
Royal	122255	023614063865	59.99
Black	122299	023614063896	59.99
Driftwood	122298	023614063889	59.99

**BUFFALO NICKEL, SOUTHWESTERN AND BARBED WIRE SLINGS**

*Buffalo Nickel*



*Southwestern*



*Barbed Wire*



**BUFFALO NICKEL**

- Basketweave design
- Full-grain leather construction with suede backing
- Unique buffalo nickel overlays
- Braided horsehair inlay
- Swivels not included

**SOUTHWESTERN**

- Jacquard weave pattern in Southwestern style
- Full-grain leather construction with suede backing
- Braided horsehair inlay
- Swivels not included

**BARBED WIRE**

- Twisted leather cord provides a barbed wire look
- Full-grain leather construction with suede backing
- Swivels not included

DESCRIPTION	CODE #	UPC #	SUGG. RETAIL
Buffalo Nickel	122602	023614059028	\$69.99
Southwestern	122603	023614059035	69.99
Barbed Wire	122604	023614059097	69.99





**SANTA FE/RIO LOBO**



- Top-grain, silicone-treated leather is padded for comfort
  - Rio Lobo sling has three cartridge loops
  - Leather ties are included on Santa Fe (Brown) and Rio Lobo models
  - Crazy Horse sling features distressed leather and includes metal swivels
  - Swivels not included on Santa Fe (Brown) and Rio Lobo models
- Cartridges shown are not included with slings.*

DESCRIPTION	CODE #	UPC #	SUGG. RETAIL
Santa Fe, Crazy Horse	122503	023614048350	\$39.99
Santa Fe, Brown, Padded	12249	023614178941	44.99
Rio Lobo	12260	023614201786	49.99

**LAREDO SLINGS**

**NEW**



*Included Knife*

**LAREDO SLING (WITH KNIFE)**

- Sling features top grain leather with white stitching and large stamped Buckmark logo
- Slip-resistant suede backing
- Heavy-duty brass hardware
- Knife fits into sewn-in pocket in sling
- Knife features rugged black grain G-10 handle and solid brass bolsters
- Razor sharp 3" drop point blade
- Reliable lockback design

**LAREDO PLUS SLING (WITH REMOVEABLE SHEATH AND KNIFE)**

- Sling features top grain leather with western stitch design and large stamped Buckmark logo
- Slip-resistant suede backing
- Classic western stitch design
- Heavy-duty brass hardware
- Removable sheath fits on sling or on a belt
- Knife features rugged black grain G-10 handle and solid brass bolsters
- Razor sharp 3" drop point blade
- Reliable lockback design

DESCRIPTION	CODE #	UPC #	SUGG. RETAIL
<b>NEW</b> Laredo Sling (with Knife)	122560	023614369998	\$44.99
<b>NEW</b> Laredo Plus Sling (with Sheath and Knife)	122561	023614370000	49.99

**LEATHER SLINGS**



- Leather western sling stitch design is sewn freehand
- Latigo is a military-style sling providing greater accuracy by bracing the rifle with a tighter fit against arm and body
- Handler slings have convenient thumb loop
- Six Mile offers a western stitch design and fast, easy adjustment from 21" - 34"
- Metal swivels included with Latigo and Six Mile only

DESCRIPTION	CODE #	UPC #	SUGG. RETAIL
Latigo Leather, Military Style (Swivels included)	12244	023614284727	\$49.99
Brown Western Stitch (Leather ties included)	1225012	023614138143	39.99
Antique Basket Weave	1225098	023614138136	39.99
Handler Sling (Leather ties included)	12245	023614806790	49.99
Six Mile	12243	023614038085	29.99



**GUNSLINGER**

**NEW**

No matter how light your rifle or shotgun is, packing it around all day can wear you down and make your shoulder sore. The new Browning Gunslinger system gives you the option of changing all that. By mounting the Gunslinger Holster on your belt or the available Rifle Belt, and strapping your firearm's pistol grip into the Holster, you share the weight of the firearm with your waist, and secure the rifle to your body. Add the optional Backpack Accessory to further secure your firearm, and have the ability to unbuckle and immediately shoulder your gun should a quick shot arise.

BACKPACK ACCESSORY



HOLSTER

RIFLE BELT



Holster

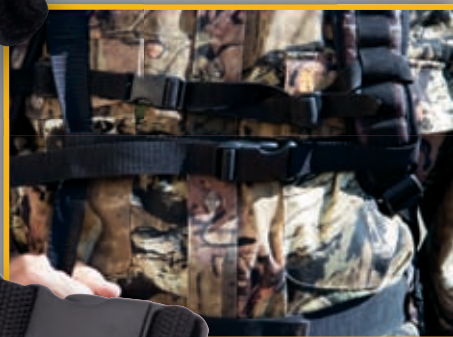

Backpack Accessory



Rifle Belt

**HOLSTER**

- Secures your rifle or shotgun to help prevent accidental dropping and excessive movement when hiking
- Fully adjustable to fit most rifles and shotguns with a pistol grip
- Rubberized hooked cradle and adjustable, quick-release buckle secures firearm in place
- Fits up to a 2" belt or backpack waist strap
- Constructed from high-quality nylon webbing
- Secure hook and loop closure secures Gunslinger Holster to your belt

**RIFLE BELT**

- Oversize belt is designed to fit over layers of clothing
- Perfect for use with the Gunslinger Holster
- Constructed from high-quality nylon webbing
- Cut-to-fit length

**BACKPACK ACCESSORY**

- Attaches to the shoulder straps of a backpack, suspenders or a bird vest
- Allows you to carry your rifle in side or front carry position (holster not included)
- Constructed from high-quality nylon webbing
- Quick adjust/quick disconnect buckle
- Ideal for both rifles and shotguns

DESCRIPTION	CODE #	UPC #	SUGG. RETAIL
<b>NEW</b> Gunslinger Holster, Black	1227199	023614370017	\$29.99
<b>NEW</b> Gunslinger Rifle Belt, Black	1227299	023614370024	14.99
<b>NEW</b> Gunslinger Backpack Accessory, Black	1227399	023614370031	9.99



MOA SHOOTING STICKS

**NEW**

A stable rest is essential to making accurate rifle shots. Unfortunately, the terrain you are in dictates the quality of the rest you have at hand, and can mean the difference between a clean shot or a miss at a once-in-a-lifetime trophy. Give yourself an edge with a set of new Browning MOA Shooting Sticks. Ultra-light, ultra-strong 6061-T6 aircraft aluminum construction minimizes flex. Collapsible MOA Shooting Sticks take down into a compact bundle small enough to carry in a backpack and internal shock cords put the sticks into action fast and keep the pole sections connected. A durable powder coat finish reduces glare. Long-wearing carbide steel tips provide positive footing. Textured rubber sleeves protect your firearm, yet allow easy repositioning. Never miss an opportunity with a set of new MOA Shooting Sticks.

Collapsible Bipod



Collapsible Tripod



**COLLAPSIBLE SHOOTING STICKS**

- Easy to carry, quick to deploy
- Extends to 40" length for sitting or kneeling shooting positions
- Lightweight 9mm aluminum legs collapse into three segments of 14½"
- Leg segments are secured by heavy-duty elastic shock cord
- 1½" internal ferrule quickly guides poles together for tight, rigid fit
- All-terrain gripper feet with carbide steel tips
- Rubber coated yoke secures gun, but allows for easy repositioning
- Textured, powder-coated poles minimize reflections

**FIXED LEG SHOOTING STICKS**

- Lightweight and easy to carry
- Ultra stable, large diameter 13mm one-piece aluminum legs
- Gripper yoke secures lower legs when hiking
- Approximately 40" length
- All-terrain gripper feet with carbide steel tips are easily removed to add leg extensions
- Rubber coated yoke secures gun, but allows for easy repositioning
- Textured, powder-coated poles minimize reflections



Fixed Leg Tripod

DESCRIPTION	CODE #	UPC #	SUGG. RETAIL
<b>NEW</b> Collapsible Bipod	129363	023614063780	\$39.99
<b>NEW</b> Collapsible Tripod	129364	023614063797	49.99
<b>NEW</b> Fixed Leg Bipod	129360	023614063759	39.99
<b>NEW</b> Fixed Leg Tripod	129361	023614063766	49.99

**EXTENSION LEGS**

**NEW**

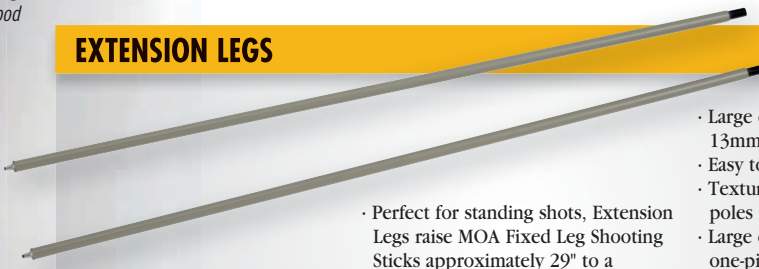

- Large diameter, one-piece 13mm aluminum extensions
- Easy to install
- Textured, powder-coated poles minimize reflections
- Large diameter 13mm one-piece aluminum legs
- Sold per individual leg

Fixed Leg Bipod

DESCRIPTION	CODE #	UPC #	SUGG. RETAIL
<b>NEW</b> Extension Legs (each leg sold individually)	129362	023614063773	\$14.99



**INTEGRATED SCOPE MOUNT SYSTEM**

- Integrated Scope Mounts unitize the ring and base into a single, ultra-rigid unit
- Machined from 7000 series aluminum
- Eliminates alignment problems and the possibility of a loose connection between bases and rings



DESCRIPTION	FINISH	CODE #	UPC #	SUGG. RETAIL
<b>INTEGRATED SCOPE MOUNT SYSTEM (AT LEFT)</b>				
<b>NEW</b> A-Bolt Shotgun	Matte Finish	12307	023614372714	\$49.99
A-Bolt Standard Height	Gloss Finish	12390	023614201472	49.99
A-Bolt Standard Height	Matte Finish	12391	023614201489	49.99
A-Bolt Intermediate Height	Gloss Finish	12392	023614201496	49.99
A-Bolt Intermediate Height	Matte Finish	12393	023614201502	49.99
A-Bolt WSSM Standard Height	Matte Finish	12380	023614200437	49.99
A-Bolt WSSM Intermediate Height	Matte Finish	12381	023614200444	49.99
A-Bolt Mountain Ti Standard Height	Matte Finish	12382	023614200451	49.99
A-Bolt Mountain Ti Intermediate Height	Matte Finish	12349	023614199168	49.99
A-Bolt Mountain Ti Standard Height	Silver Finish	12387	023614204213	49.99
A-Bolt Mountain Ti Intermediate Height	Silver Finish	12388	023614204220	49.99
BAR, BLR Standard Height	Gloss Finish	12394	023614201519	49.99
BAR, BLR Standard Height	Matte Finish	12377	023614204190	49.99
BAR, BLR Intermediate Height	Gloss Finish	12395	023614201526	49.99
BAR, BLR Intermediate Height	Matte Finish	12376	023614204206	49.99
T-Bolt Standard Height	Matte Finish	12338	023614038115	49.99

**SCOPE BASES**

- Browning Scope Bases are machined from solid steel
- Double recoil shoulder design holds rings securely, even under magnum recoil
- Compatible only with Browning Scope Rings below
- T-Bolt two-piece and SA-22 one-piece base designs are alloy and only compatible with Browning rimfire rings (Code 12365)
- Gold, Silver, BPS and Buck Mark bases are Weaver-type bases and are not compatible with Browning rings
- BLR Takedown bases are Weaver-type, one-piece scout-style bases for a long eye-relief scope, and are not compatible with Browning rings

DESCRIPTION	FINISH	CODE #	UPC #	SUGG. RETAIL
<b>SCOPE BASES (BELOW)</b>				
A-Bolt (two-piece)	Matte Finish	12331	023614201441	\$29.99
A-Bolt Mountain Ti (two-piece)	Matte Finish	12339	023614204237	29.99
A-Bolt (two-piece)	High Lustre Finish	12330	023614201434	29.99
BAR, BLR (two-piece)	High Lustre Finish	12332	023614201458	29.99
BLR Takedown Short Action (one-piece)	Matte Finish	12327	023614038153	69.99
BLR Takedown WSM/LA/Mag (one-piece)	Matte Finish	12326	023614039136	69.99
BLR Takedown 450 Marlin (one-piece)	Matte Finish	12325	023614039143	69.99
Gold/Silver/BPS 10 and 12 ga. (one-piece)	Matte Finish	12360	023614180210	34.99
Buck Mark (one-piece)	Matte Finish	12328	023614038146	34.99
T-Bolt (two-piece)	Matte Finish	12389	023614204268	29.99
SA-22 (one-piece)	Matte Finish	12333	023614201465	59.99



**SCOPE RINGS**



DESCRIPTION	FINISH	CODE #	UPC #	SUGG. RETAIL
<b>SCOPE RINGS (AT LEFT)</b>				
1" Standard Height — per pair	Matte Finish	12343	023614201588	\$84.99
1" Intermediate Height — per pair	Matte Finish	12344	023614201595	84.99
1" High Height — per pair	Matte Finish	12345	023614201601	84.99
1" Standard Height — per pair	High Lustre Finish	12340	023614201557	84.99
1" Intermediate Height — per pair	High Lustre Finish	12341	023614201564	84.99
1" High Height — per pair	High Lustre Finish	12342	023614201571	84.99
30mm Standard Height — per pair	Matte Finish	12346	023614201618	84.99
30mm Intermediate Height — per pair	Matte Finish	12347	023614201625	84.99
30mm High Height — per pair	Matte Finish	12348	023614201632	84.99
1" Rimfire Standard Height — per pair	Matte Finish	12365	023614038023	49.99

- Ultra-rigid vertically split rings use oversize hardware for extra strength and ease of installation
- Standard, Intermediate and High rings are available for both 1" and 30mm diameter scopes
- Compatible with the two-piece Scope Bases for A-Bolt, BAR, BLR shown above and the X-Lock bases for X-Bolt rifles shown on page 137

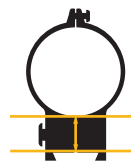

THE HEIGHT IS DETERMINED BY MEASURING FROM THE TOP OF THE BASE TO THE BOTTOM OF THE SCOPE RING.\*

**STANDARD (.300")**

For scopes with an objective up to 44mm and a standard barrel contour

**INTERMEDIATE (.400")**

For scopes with an objective up to 50mm and a standard barrel contour

**HIGH (.500")**

For scopes with an objective up to 56mm and a standard barrel contour

\* Barrel contour, optic size and preferred eye relief all affect the fit of the scope on a rifle.





**X-LOCK™ MOUNTING SYSTEM SCOPE RINGS AND BASES FOR X-BOLT™ RIFLES**



DESCRIPTION	FINISH	CODE #	UPC #	SUGG. RETAIL
<b>X-LOCK INTEGRATED 1" MOUNTS</b>				
Matte Standard Integrated	Matte Finish	12501	023614047575	\$59.99
Matte Intermediate Integrated	Matte Finish	12502	023614047582	59.99
Matte High Integrated	Matte Finish	12503	023614047599	59.99
Gloss Standard Integrated	Gloss Finish	12504	023614047605	59.99
Gloss Intermediate Integrated	Gloss Finish	12505	023614047612	59.99
Gloss High Integrated	Gloss Finish	12506	023614047629	59.99
Nickel Standard Integrated	Nickel Finish	12507	023614047636	59.99
Nickel Intermediate Integrated	Nickel Finish	12508	023614047650	59.99
Nickel High Integrated	Nickel Finish	12509	023614047735	59.99
<b>X-LOCK INTEGRATED 30mm MOUNTS</b>				
Matte Standard Integrated, 30mm	Matte Finish	12510	023614047827	\$59.99
Matte Intermediate Integrated, 30mm	Matte Finish	12511	023614047889	59.99
Matte High Integrated, 30mm	Matte Finish	12512	023614047933	59.99
Gloss Standard Integrated, 30mm	Gloss Finish	12513	023614047957	59.99
Gloss Intermediate Integrated, 30mm	Gloss Finish	12514	023614047964	59.99
Gloss High Integrated, 30mm	Gloss Finish	12515	023614047988	59.99
Nickel Standard Integrated, 30mm	Nickel Finish	12516	023614047995	59.99
Nickel Intermediate Integrated, 30mm	Nickel Finish	12517	023614048015	59.99
Nickel High Integrated, 30mm	Nickel Finish	12518	023614048060	59.99
<b>X-LOCK BASES (A LIST OF COMPATIBLE SCOPE RINGS CAN BE FOUND ON PAGE 136)</b>				
Matte, Base	Matte Finish	12334	023614048121	\$39.99
Gloss, Base	Gloss Finish	12362	023614048152	39.99

- Integrated Scope Mounts unite the ring and base into a single unit
- Machined from 7000 series aluminum
- Eliminates alignment problems and loose connections between bases and rings
- Choose from integrated mounts in Standard, Intermediate and High rings
- Will accommodate both 1" and 30mm diameter scopes in gloss, matte and nickel finishes
- X-LOCK™ bases also use standard Browning rings (See page 136)



**SOLID X-LOCK™ MOUNTS** Securely mounted optics are essential to the accuracy and precision of any rifle. To ensure the X-Bolt has the most stable mount possible, it features the X-LOCK scope mounting system that uses four screws per base, replacing the traditional two-screw standard. The benefits mean the scope bases are secured at all four corners rather than only held at the center of the base, and offers more accurate placement of the bases on the receiver. The revolutionary X-LOCK system holds the base tighter to the rifle than any other system.

**X-BOLT EXTRA MAGAZINES**



The X-Bolt uses a detachable rotary magazine constructed from a durable lightweight polymer. The magazine is designed to feed cartridges directly in line with the bolt, instead of offset as with traditional leaf-spring magazines, for a straight path right into the chamber. An ergonomic magazine-mounted release lets the magazine rotate directly downward and into the hand. The magazine sits flush with the bottom of the rifle for a sleeker appearance. Additional magazines can be kept loaded and carried in your pocket or pack for easy, safe access.

DESCRIPTION	CODE #	UPC #	SUGG. RETAIL
Long Action Magnum: 338 Win. Mag., 300 Win. Mag., 7mm Rem. Mag.	112044601	023614048183	\$49.99
Long Action Standard: 30-06 Sprg., 280 Rem., 270 Win., 25-06 Rem.	112044602	023614048213	49.99
Short Action Magnum: 325 WSM, 300 WSM, 7mm WSM, 270 WSM	112044603	023614048244	49.99
Short Action Standard: 308 Win., 7mm-08 Rem., 243 Win.	112044604	023614048275	49.99
Super Short Action Standard: 223 Rem.	112044008	023614059103	49.99
Super Short Action Standard: 22-250 Rem.	112044009	023614059080	49.99
Large Magnum: 375 H&H Magnum	112044606	023614048305	49.99





**BOSS®-CR ACCESSORY**



The BOSS-CR accessory offers all the accuracy and tunable advantages of the original BOSS device without the muzzle brake feature. By simply replacing the original BOSS forward weight and recoil reduction components with the one-piece, no-hole BOSS-CR accessory, only the reduced recoil of the original BOSS is sacrificed. The BOSS-CR accessory is designed to fit only BAR Mark II and A-Bolt centerfire rifles previously factory-fitted with the BOSS.

GLOSS	MATTE	STAINLESS
BAR SAFARI AND THE FOLLOWING A-BOLT MODELS: MEDALLION GOLD MEDALLION	A-BOLT MODELS: COMPOSITE STALKER HUNTER EURO-BOLT VARMINT ECLIPSE HUNTER M-1000 ECLIPSE	A-BOLT MODELS: STAINLESS STALKER WHITE GOLD MEDALLION M-1000 ECLIPSE



**A-BOLT® EXTRA MAGAZINES**

CALIBER	CODE #	UPC #	SUGG. RETAIL
<b>EXTRA MAGAZINES (ALL RIFLE MODELS EXCEPT MICRO HUNTER)</b>			
222 Rem.	112022007	023614047490	\$69.99
204 Ruger	112022066	023614202974	69.99
22-250 Rem.	112022009	023614027072	69.99
223 Rem.	112022008	023614829324	69.99
223 WSSM	112022044	023614182429	69.99
223 Rem. SSA	112022060	023614316848	69.99
243 Win.	112022011	023614027089	69.99
243 WSSM	112022045	023614182436	69.99
270 WSM	112022035	023614180180	69.99
7mm-08 Rem.	112022016	023614027164	69.99
7mm WSM	112022036	023614180197	69.99
308 Win.	112022018	023614027126	69.99
300 WSM	112022034	023614179498	69.99
25 WSSM	112022049	023614199458	69.99
25-06 Rem.	112022023	023614027096	69.99
270 Win.	112022024	023614027102	69.99
280 Rem.	112022025	023614826835	69.99
30-06 Sprg.	112022026	023614027119	69.99
7mm Rem. Mag.	112022027	023614027133	69.99
300 Win. Mag.	112022029	023614027140	69.99
300 Ultra Mag.	112022030	023614179764	69.99
325 WSM	112022065	023614201816	69.99
338 Win. Mag.	112022031	023614027157	69.99
375 H&H Mag.	112022032	023614840121	69.99
338 Ultra Mag.	112022038	023614179757	69.99
<b>EXTRA MAGAZINES (MICRO HUNTER RIFLE)</b>			
22 Hornet	112023006	023614165668	\$69.99
22-250 Rem.	112023009	023614842965	69.99
243 Win.	112023011	023614842972	69.99
270 WSM	112023041	023614182405	69.99
7mm WSM	112023042	023614182412	69.99
7mm-08 Rem.	112023016	023614842996	69.99
308 Win.	112023018	023614842989	69.99
300 WSM	112023040	023614182399	69.99
325 WSM	11202304	023614204886	69.99
<b>EXTRA MAGAZINES (A-BOLT SHOTGUN)</b>			
<b>NEW</b> 12 Gauge	112022001	023614372707	\$69.99

NOTE: Magazines that are not listed above may be available only through the Browning Parts Department at (800) 322-4626. Cartridges shown not included.

CALIBER	CODE #	CODE #	CODE #
223 Rem.	1140011 023614645078	1140012 023614645085	1140013 023614645092
223 Varmint	1140061 023614645221	1140062 023614645238	—
223 WSSM	1140011 023614645078	1140012 023614645085	1140013 023614645092
243 WSSM	1140011 023614645078	1140012 023614645085	1140013 023614645092
25 WSSM	1140011 023614645078	1140012 023614645085	1140013 023614645092
22-250 Rem.	1140011 023614645078	1140012 023614645085	1140013 023614645092
22-250 Varmint	1140061 023614645221	1140062 023614645238	—
22-250 Varmint(M-1000)	—	1140062 023614645238	1140063 023614253013
243 Win.	1140011 023614645078	1140012 023614645085	1140013 023614645092
7mm-08 Rem.	1140011 023614645078	1140012 023614645085	1140013 023614645092
308 Win.	1140021 023614645108	1140022 023614645115	1140023 023614645122
308 Varmint	1140061 023614645221	1140062 023614645238	—
308 Varmint (M-1000)	—	1140062 023614645238	1140063 023614253013
25-06 Rem.	1140011 023614645078	1140012 023614645085	1140013 023614645092
260 Rem.	1140011 023614645078	1140012 023614645085	1140013 023614645092
270 WSM	1140021 023614645108	1140022 023614645115	1140023 023614645122
270 Win.	1140011 023614645078	1140012 023614645085	1140013 023614645092
280 Rem.	1140011 023614645078	1140012 023614645085	1140013 023614645092
30-06 Sprg.	1140031 023614645139	1140032 023614645146	1140033 023614645153
7mm WSM	1140021 023614645108	1140022 023614645115	1140023 023614645122
7mm Rem. Mag.	1140021 023614645108	1140022 023614645115	1140023 023614645122
300 WSM	1140041 023614645160	1140042 023614645177	1140043 023614645184
300 WSM (M-1000)	—	1140092 023614000433	1140093 023614253020
300 Win. Mag.	1140041 023614645160	1140042 023614645177	1140043 023614645184
300 Win. Mag. (M-1000)	—	1140092 023614000433	—
325 WSM	1140051 023614645191	1140052 023614645207	1140053 023614645214
338 Win. Mag.	1140051 023614645191	1140052 023614645207	1140053 023614645214
375 H&H Mag.	1140071 023614645245	—	1140073 023614645252

It is important that the correct BOSS-CR be selected for a specific caliber and model of rifle.

MODEL	SUGG. RETAIL
BOSS-CR, matte blue	\$29.00
BOSS-CR, gloss blue	29.00
BOSS-CR, stainless	39.00





**EXTRA MAGAZINES**

It makes good sense to always carry an extra magazine in your pocket or pack for fast reloading.

**BAR® EXTRA MAGAZINES**

CALIBER	CODE #	UPC #	SUGG. RETAIL
<b>EXTRA MAGAZINES, BAR MARK II AND LIGHTWEIGHT STALKER</b>			
243 Win. and 308 Win.	112025011	023614975991	\$69.99
270 WSM	112025041	023614182498	69.99
7mm WSM	112025042	023614182504	69.99
300 WSM	112025030	023614180203	69.99
<b>EXTRA MAGAZINES, BAR LONGTRAC, BAR MARK II, SAFARI AND LIGHTWEIGHT STALKER</b>			
270 Win., 25-06 Rem., 30-06 Sprg.	112025024	023614975984	\$69.99
300 Win. Mag.	112025029	023614976004	69.99
338 Win. Mag.	112025031	023614976011	69.99
7mm Rem. Mag.	112025027	023614629528	69.99
<b>EXTRA MAGAZINES, BAR SHORTTRAC</b>			
243 Win. and 308 Win.	112025050	023614199526	\$69.99
7mm-08 Rem.	112025051	023614061694	69.99
270 WSM	112025055	023614199533	69.99
7mm WSM	112025055	023614199533	69.99
300 WSM	112025055	023614199533	69.99
325 WSM	112025052	023614061700	69.99

**HI POWER EXTRA MAGAZINES**

CALIBER	CODE #	UPC #	SUGG. RETAIL
<b>EXTRA HI POWER PISTOL MAGAZINES (10-SHOT CAPACITY)</b>			
9mm, S.A., H.P., Standard	112050193	023614630012	\$59.99
9mm, S.A., H.P., Pachmayr	112051193	023614630029	59.99
40 S&W, S.A., H.P., Standard	112050194	023614630036	59.99
40 S&W, S.A., H.P., Pachmayr	112051194	023614644477	59.99

**DOUBLE HELIX® MAGAZINES FOR T-BOLT™ RIFLES**

CALIBER	CODE #	UPC #	SUGG. RETAIL
22 L.R.	112055290	023614203964	\$49.99
17 HMR/22 WMR	112055291	023614048091	49.99



Patent pending Double Helix® rotary box magazine · Torsion spring driven interlocking gears provide added reliability plus easy loading and unloading · 10-round capacity

.22 Long Rifle

17 HMR/22 WMR



Buck Mark Magazine

Buck Mark Magazine, .22 Long Rifle



Hi Power Magazine



1911-22 Magazine, .22 Long Rifle

**BUCK MARK® EXTRA MAGAZINES**

CALIBER	CODE #	UPC #	SUGG. RETAIL
<b>EXTRA BUCK MARK PISTOL AND RIFLE MAGAZINES</b>			
22 L.R.	112055190	023614025290	\$29.99

**1911-22 EXTRA MAGAZINES**

CALIBER	CODE #	UPC #	SUGG. RETAIL
<b>EXTRA 1911-22 MAGAZINES</b>			
<b>NEW</b> 22 L.R.	112055191	023614370123	\$29.99

Cartridges shown not included.



**BUCK MARK® PISTOL HOLSTERS**

Magazine Pouch



- Tough ballistic nylon construction
- Closed cell padding
- Fits most Buck Mark pistols
- Oversized model available will accommodate a small scope or reflex sight
- Magazine pouch model keeps a magazine handy
- Belt loop
- Rubberized Buckmark logo

**NEW**

*Buck Mark Pistol Holster with Magazine Pouch*

*Oversized Buck Mark Pistol Holster*

*Buck Mark Pistol Holster*

DESCRIPTION	CODE #	UPC #	SUGG. RETAIL
<b>NEW</b> Buck Mark Holster w/ Magazine Pouch	12902012	023614370062	\$24.99
Buck Mark Holster	12902010	023614063698	19.99
Oversized Buck Mark Holster (fits small optics)	12902011	023614063704	19.99

*Pistols and magazines shown are not included.*

**1911-22 HOLSTER**



1911  22

**NEW**

- Tough ballistic nylon construction
- Closed cell padding
- Fits 1911-22 pistols
- Magazine pouch
- Belt loop
- Rubberized Buckmark logo

DESCRIPTION	CODE #	UPC #	SUGG. RETAIL
<b>NEW</b> 1911-22 Holster	12903012	023614370093	\$24.99

*Pistols and magazines shown are not included.*



**FLEX FOAM BUCK MARK® PISTOL CASE**



- Carry case fits Buck Mark pistol and two magazines
- 600 denier polyester shell
- Soft laminated nylon tricot lining
- Nylon carry straps
- Form-fitting EVA foam secures the contents
- Sturdy zipper closure
- D-rings for attaching a shoulder strap (not included)

DESCRIPTION	SIZE	CODE #	UPC #	SUGG. RETAIL
Pistol Case	15"	1419001	023614015659	\$49.95

*Pistols and magazines shown are not included.*

**FLEX FOAM 1911-22 PISTOL CASE**

1911  22



**NEW**

- Carry case fits 1911-22 pistol and one magazines
- 600 denier polyester shell
- Soft laminated nylon tricot lining
- Nylon carry straps
- Form-fitting EVA foam secures the contents
- Sturdy zipper closure
- D-rings for attaching a shoulder strap (not included)

*Pistols and magazines shown are not included.*

DESCRIPTION	SIZE	CODE #	UPC #	SUGG. RETAIL
<b>NEW</b> Pistol Case	11"	12903031	023614370116	\$39.99

**1911-22/BUCK MARK® PISTOL RUG**



**NEW**

- Fits both 1911-22 pistols and Buck Mark pistols (up to a 5½" barrel)
- Tough ballistic nylon construction
- Outer pocket secures three spare magazines
- Padded to protect pistol
- Two-way zipper

DESCRIPTION	CODE #	UPC #	SUGG. RETAIL
<b>NEW</b> 1911-22/Buck Mark Pistol Rug	12902030	023614370086	\$24.99

*Pistols and magazines shown are not included.*



1911-22/BUCK MARK® MAGAZINE HOLDER

**NEW**

- Tough ballistic nylon construction
- Carries one 1911-22 or Buck Mark Pistol or Rifle magazine
- Larger pocket holds extra .22 cartridges
- Hook and loop closures
- Belt loops



*Magazine and ammunition shown is not included.*

DESCRIPTION	CODE #	UPC #	SUGG. RETAIL
<b>NEW</b> 1911-22/Buck Mark Magazine Holder	12902021	023614370079	\$19.99

BUCK MARK® REFLEX SIGHT



- Four reticle patterns: Circle-Dot-Cross Reticle, 3 MOA Dot Reticle, Cross-Dot Reticle, Circle-Dot Reticle
- Seven-position brightness rheostat
- Field-of-view: 15.7m/100m
- Unlimited eye relief
- Powered by one #2032 lithium battery
- Mounts to a standard Weaver-style base
- Rugged aluminum housing with matte black finish



*Buck Mark Scope Base*

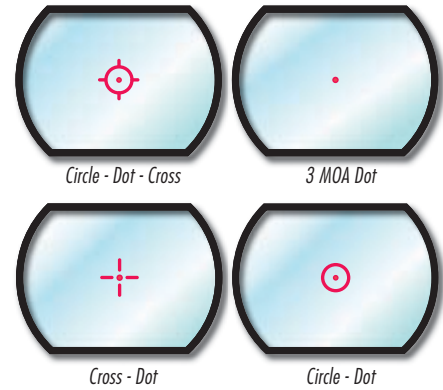

DESCRIPTION	FINISH	CODE #	UPC #	SUGG. RETAIL
Buck Mark Reflex Sight	Matte Finish	1290230	023614063728	\$49.99
Buck Mark Scope Base (one-piece)	Matte Finish	12328	023614038146	34.99

BUCK MARK® HI-VIZ® PISTOL SIGHT

- A great performance upgrade for the Buck Mark Pistol
- Speeds target acquisition
- Fits Browning Buck Mark Plus, Camper, Standard and Micro models
- Easy single screw installation, replaces factory sight
- Includes six LitePipes, three green and three red

DESCRIPTION	CODE #	UPC #	SUGG. RETAIL
Buck Mark Pistol Sight	12875	023614179139	\$39.99





**CARTRIDGE CASES**

**1 ▶ FLEX FOAM™ CARTRIDGE CASE**

- Waterproof, molded foam is lightweight and comfortable
- Holds 10 rifle cartridges
- Quiet hook closure
- Double belt loop

**2 ▶ FLEX FOAM™ CARTRIDGE CARRIER**

- Durable Flex Foam construction
- Triple stitched nylon-webbed belt loop or clips to hang on belt or pants
- Folding design holds 10 rifle cartridges for easy, quick access
- Hook and loop for easy, quick open/closure

**3 ▶ LEATHER CARTRIDGE CASE**

- Top-grain leather construction
- Folding design holds 10 rifle cartridges for easy, quick access
- Belt loop

**4, 5 ▶ CRAZY HORSE LEATHER CARTRIDGE CASE**

- Top-grain leather construction
- Folding design holds 10 rifle cartridges for easy, quick access
- Available in standard and magnum cartridge models
- Belt loop

**6, 7 ▶ FLEX FOAM™ MAGAZINE CASE**

- Lightweight Flex Foam construction
- Quiet magnetic closure
- Holds magazines for all Browning rifles
- Quick-release buckle belt loop
- Available in Black and Mossy Oak® New Break-Up®

*Cartridges and magazines shown are not included.*

DESCRIPTION	CAPACITY	CODE #	UPC #	SUGG. RETAIL
1 ▶ Flex Foam Cartridge Case	10 rifle cartridges	12180	023614179092	\$24.99
2 ▶ Flex Foam Cartridge Carrier	10 rifle cartridges	12191	023614182023	29.99
3 ▶ Leather Cartridge Case	10 rifle cartridges	12195	023614191810	34.99
4 ▶ Crazy Horse Leather Cartridge Case	10 rifle cartridges	12198	023614048565	39.99
5 ▶ Crazy Horse Magnum Cartridge Case	10 rifle cartridges	12199	023614048558	39.99
6 ▶ Flex Foam Magazine Case, Black	1 rifle magazine	12166	023614055631	24.99
7 ▶ Flex Foam Magazine Case, MONBU	1 rifle magazine	12167	023614058199	24.99



**SHELL SAVER, BINO HARNESS, SCOPE COVER**

**1 ▶ SHELL SAVER**

- Padded neoprene cover slips over buttstock
- Flex foam pocket holds four rifle cartridges
- Accommodates sling swivels
- Textured molded foam recoil pad

**2 ▶ BINO HARNESS**

- Keeps binoculars accessible and holds them securely on the chest to prevent bouncing
- Elastic straps allow the binoculars to slide up and down the harness
- Accommodates most binoculars

**3 ▶ SCOPE COVER**

- Padded neoprene is easy, fast and silent to remove
- Stays attached to the scope
- End caps offer full protection
- 40mm and 50mm sizes available

*Cartridges, rifle, scope and binoculars shown are not included.*



**NEW**

DESCRIPTION	CODE #	UPC #	SUGG. RETAIL
<b>NEW</b> Shell Saver	12901	023614369578	\$29.99
<b>NEW</b> Bino Harness	12903	023614369592	29.99
<b>NEW</b> Scope Cover, 40mm	12902	023614369585	29.99
<b>NEW</b> Scope Cover, 50mm	12904	023614369615	29.99



**WATERFOWLER'S COMBO KIT**

**NEW**

**SPORTER SLING** - Features waterproof, extra-thick molded foam for the ultimate in comfort · Back side is textured for a positive, non-slip grip · Sling swivels not included · Mossy Oak® Duck Blind® camo

**PADDED DUCK STRAP** - Features waterproof, extra-thick molded foam for the ultimate in comfort · Three web straps on each side, with D-rings on the end of each web strap

**CALL LANYARD** - Braided nylon construction with friction ring for easy length adjustment · Five slipknot loops for calls · Two slipknot loops with clips for whistles, flashlights or other accessories · Neoprene neck pad



DESCRIPTION	CODE #	UPC #	SUGG. RETAIL
<b>NEW</b> Waterfowler's Combo Kit	129270	023614370130	\$49.99

**RIFLEMAN'S COMBO KIT**

**SPORTER SLING** - Features waterproof, extra-thick molded foam for the ultimate in comfort · Back side is textured for a positive, non-slip grip · Swivels not included

**TWO-PIECE NEOPRENE SCOPE COVER** - Stays attached to the scope · End caps offer full protection · Fits up to 40mm scopes

**NEOPRENE BUTTSTOCK COVER** - Slips over buttstock · Elastic loops hold rifle cartridges · Textured molded foam recoil pad for additional comfort



*Rifle, scope, mounts and cartridges not included.*

DESCRIPTION	CODE #	UPC #	SUGG. RETAIL
Rifleman's Combo Kit	129240	023614063735	\$49.99

**HUNTER'S COMBO KIT**

**SPORTER SLING** - Features waterproof, extra-thick molded foam for the ultimate in comfort · Back side is textured for a positive, non-slip grip · Swivels not included

**BINOCULAR HARNESS** - Keeps binoculars accessible and holds them securely on the chest to prevent bouncing · Elastic straps allow the binoculars to slide up and down the harness · Accommodates most binoculars

**NEOPRENE BUTTSTOCK COVER** - Slips over buttstock · Elastic loops hold rifle cartridges · Textured molded foam recoil pad for additional comfort



*Rifle, scope, mounts, binoculars and cartridges not included.*

DESCRIPTION	CODE #	UPC #	SUGG. RETAIL
Hunter's Combo Kit	129250	023614063742	\$49.99





**HIVIZ® 4-IN-1 GAME SIGHT**



- Includes both front and rear sights, making the 4-in-1 perfect for deer, turkey, waterfowl and upland hunting
- Injection-molded optical-grade resin sight construction
- Rear sight is fully adjustable for windage and elevation
- Light-gathering LitePipes make low-light shooting effortless
- Mounts easily with no gunsmithing required

DESCRIPTION	CODE #	UPC #	SUGG. RETAIL
4-in-1 Game Sight	12893	023614048589	\$39.99

**HIVIZ® BIRD BUSTER MAGNETIC SHOTGUN SIGHTS**



- HiViz® Bird Buster magnetic sights come with four interchangeable LitePipes of different diameters for different light conditions
- Includes three sizes of magnetic bases to fit the rib on any shotgun
- Mounts easily with no gunsmithing required
- Fits all Browning shotguns

DESCRIPTION	CODE #	UPC #	SUGG. RETAIL
Bird Buster Sight	12859	023614201731	\$19.99

**HIVIZ® COMP SIGHT**



- Metal base threads directly into the bead of shotguns for a more permanent sight picture
- Interchangeable LitePipes allow shooter to match light pipe diameter and color to shooting conditions
- Includes one white, four green and three red LitePipes
- Used by top professional shooters

- Allows the shooter to know exactly where the barrel is in relation to the target
- Metal base
- Five screw sizes, 3/56, 3x.5, 3x.6, 5/40 and 6/48 to fit most shotguns
- Key and custom carrying case included (not shown)

DESCRIPTION	CODE #	UPC #	SUGG. RETAIL
Comp Sight	12850	023614007999	\$39.99

**CHOKE TUBE CASES**

**1 ▶ CORDURA® NYLON CHOKE TUBE CASE**

- Rugged Cordura nylon construction
- Holds three extended choke tubes and a wrench
- Belt loop

**2 ▶ FLEX FOAM™ ZIPPERED CHOKE TUBE CASE**

- Molded foam with rugged nylon cover
- Holds five extended choke tubes
- Accessory pocket holds small items

**3 ▶ FLEX FOAM™ CHOKE TUBE CASE**

- Waterproof, molded foam is lightweight and comfortable
- Holds four extended choke tubes
- Belt loop

**4 ▶ LEATHER CHOKE TUBE CASE**

- Accommodates four flush choke tubes and a wrench
- Belt loop

**5 ▶ CRAZY HORSE LEATHER CHOKE TUBE CASE**

- Accommodates four extended choke tubes and a wrench
- Belt loop

**6 ▶ HARD CASE**

- Accommodates six extended choke tubes and a wrench
- Hinged lid

DESCRIPTION	CAPACITY	CODE / UPC #	SUGG. RETAIL
1 ▶ Cordura, Black	3 Invector tubes and wrench	1210120 023614166221	\$19.99
2 ▶ Flex Foam Zippered, Black	5 Invector tubes and pocket	1211130 023614063636	29.99
3 ▶ Flex Foam, Black	4 Invector tubes and wrench	12170 023614179078	24.99
4 ▶ Leather	4 Invector tubes and wrench	12163 023614567424	29.99
5 ▶ Crazy Horse Leather	4 Invector tubes and wrench	12165 023614048541	34.99
6 ▶ Hard Case	6 Invector tubes and wrench	1211135 023614063629	9.99



**STANDARD INVECTOR™ CHOKE TUBES**

- Standard Invector™ tubes are available in constrictions ranging from Cylinder to Extra-Full
- Produces excellent patterns with uniform densities
- All Browning tubes are set to industry constriction standards
- Flush fit tubes do not extend beyond end of barrel (Except XF Trap and XF Turkey models)
- Constructed of highly polished, 17-4 stainless steel for the ultimate in performance and durability



Standard Invector™ Choke Tube



The T-Wrench allows greater leverage to be applied when tightening a tube.

DESCRIPTION	10 GA. CODE #	SUGG. RETAIL	12 GA. CODE/UPC #	16 GA. CODE/UPC #	20 GA. CODE/UPC #	28 GA. CODE/UPC #	.410 BORE CODE/UPC #	SUGG. RETAIL
<b>STANDARD INVECTOR WRENCHES, CHOKE TUBES</b>								
T-Wrench	—	—	1130013 023614993919	—	1130035 023614630753	1130016 023614632108	1130017 023614632146	\$19.99
Wrench	1130048 023614848035	\$9.99	1130048 023614848035	1130048 023614848035	1130048 023614848035	—	—	9.99
Dual Invector Wrench	1130050 023614570455	12.99	1130050 023614570455	1130050 023614570455	1130050 023614570455	—	—	12.99
X-Full Trap Special (Extended Tube)	—	—	1130323 023614840107	—	—	—	—	34.99
X-Full Turkey/Trap Spcl. (Extended Tube)	1130311 023614239968	34.99	1130343 023614282884	—	—	—	—	49.99
Rifled Deer Spcl. Matte	—	—	1130363 023614645962	—	—	—	—	59.99
Full Choke	1130251 023614840046	34.99	1130253 023614033912	1130254 023614827054	1130255 023614093671	1130256 023614631842	1130257 023614631897	24.99
Improved Modified	—	—	1130263 023614033929	—	—	—	—	24.99
Modified	1130271 023614848053	34.99	1130273 023614033936	1130274 023614827078	1130275 023614093688	1130276 023614631859	1130277 023614631903	24.99
Improved Cylinder	1130281 023614840060	34.99	1130283 023614033943	1130284 023614827061	1130285 023614093695	1130286 023614631866	1130287 023614631910	24.99
Skeet	—	—	1130293 023614033950	1130294 023614843344	1130295 023614093701	1130296 023614631873	1130297 023614631927	24.99
Cylinder	—	—	1130303 023614033967	1130304 023614843351	1130305 023614093718	—	—	24.99

**INVECTOR-PLUS™ CHOKE TUBES**



The Speed Wrench allows for quick and easy choke removal. Fits most Browning choke tubes.



The T-Wrench allows greater leverage to be applied when tightening a tube.



Invector-Plus™ Choke Tube

DESCRIPTION	12 GA. CODE/UPC #	20 GA. CODE/UPC #	SUGG. RETAIL
<b>INVECTOR-PLUS WRENCHES, CHOKE TUBES</b>			
T-Wrench	1130023 023614993926	1130035 023614630753	\$19.99
Speed Wrench	1130060 023614204138	1130070 023614204145	39.99
Wrench	1130053 023614154587	—	9.99
Dual Invector Wrench	1130050 023614570455	1130050 023614570455	12.99
X-Full Turkey/Trap Spcl. (Extended Tube)	1130833 023614239925	—	49.99
Full	1130753 023614154532	1130755 023614631798	29.99
Improved Modified	1130763 023614154549	—	29.99
Modified	1130773 023614154556	1130775 023614631804	29.99
Improved Cylinder	1130783 023614154563	1130785 023614631811	29.99
Skeet	1130793 023614154570	1130795 023614631828	29.99
Cylinder	1130803 023614240358	1130805 023614631835	29.99

- Invector-Plus™ tubes are available in constrictions ranging from Cylinder to Extra-Full
- Longer choke taper inside Invector-Plus choke tubes for use with back-bored barrels
- Produces excellent patterns with uniform densities

- All Browning tubes are set to industry constriction standards
- Flush fit tubes do not extend beyond end of barrel (Except XF Trap and XF Turkey models)
- Constructed of highly polished, 17-4 stainless steel for the ultimate in performance and durability





MIDAS™ GRADE EXTENDED CHOKE TUBES

STANDARD  
**INVECTOR™**

**INVECTOR-Plus™**

- Extends beyond the end of barrel for easy removal and installation
- Stainless steel with black oxide finish
- Laser-etched gold accent band
- Minimum gap geometry plus high-resolution “RMS” finish reduce buildup of plastics in the shotgun bore
- Invector-Plus™ long taper choke tube technology on 12 and 20 gauge
- Browning Midas™ Grade choke tubes produce tighter patterns than Browning Invector-Plus flush choke tubes (28 gauge and .410 bore are Standard Invector™ chokes)



DESCRIPTION	CONSTRUCTION (INCHES)	12 GA. CODE/UPC #	20 GA. CODE/UPC #	28 GA. CODE/UPC # (STD. INVECTOR)	.410 BORE CODE/UPC # (STD. INVECTOR)	SUGG. RETAIL
Extra-Full Trap	.040"	1130123 023614180135	—	—	—	\$49.99
Full	.035"	1130153 023614178910	1130653 023614182757	1130953 023614184300	1131153 023614184348	49.99
Improved Modified	.025"	1130163 023614007883	1130663 023614182740	1130063 023614184621	1131163 023614184645	49.99
Modified	.020"	1130173 023614000419	1130673 023614182733	1130073 023614184317	1131173 023614184355	49.99
Light Modified	.015"	1130133 023614007807	1130633 023614199687	1130033 023614184638	1131133 023614184652	49.99
Improved Cylinder	.010"	1130183 023614007906	1130683 023614182726	1130083 023614184324	1131183 023614184362	49.99
Skeet	.005"	1130193 023614007814	1130693 023614182719	1130993 023614184331	1131193 023614184379	49.99
Cylinder	.000"	1130113 023614180128	—	—	—	49.99
Spreader*	—	1130103 023614007920	—	—	—	69.99
Extended 12 Ga. Choke Tube T-Wrench	—	1130038 023614204183	—	—	—	19.99

\* Helically rifled to spin the shot charge and spread the pattern.  
Flat choke tube wrench is not compatible with Midas Grade choke tubes.



DIAMOND GRADE CHOKE TUBES

INVECTOR-Plus™

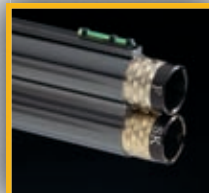

STANDARD  
**INVECTOR™**

- Longer choke taper inside Invector-Plus™ choke tubes for use with back-bored barrels on 12 and 20 gauge shotguns
- Matching tubes for the Citori 625 Sporting
- 17-4 stainless steel construction
- Absolutely perfect concentricity for superior patterning

- Diamond-cut knurling extends beyond the end of the barrel for easy removal and installation
- Titanium nitride finish with black accent band
- Browning Diamond Grade choke tubes produce tighter patterns than Browning Invector-Plus flush choke tubes (28 gauge and .410 bore are Standard Invector™ chokes)

DESCRIPTION	CONSTRUCTION (INCHES)	12 GA. CODE/UPC #	20 GA. CODE/UPC #	28 GA. CODE/UPC # (STD. INVECTOR)	.410 BORE CODE/UPC # (STD. INVECTOR)	SUGG. RETAIL
Full	.035"	1134153 023614048435	1135153 023614058731	1136153 023614058809	1137153 023614058878	\$69.99
Improved Modified	.025"	1134163 023614048442	1135163 023614058748	1136163 023614058816	1137163 023614058885	69.99
Modified	.020"	1134173 023614048459	1135173 023614058755	1136173 023614058823	1137173 023614058892	69.99
Light Modified	.015"	1134133 023614055624	1135133 023614058762	1136133 023614058830	1137133 023614058908	69.99
Improved Cylinder	.010"	1134183 023614048466	1135183 023614058779	1136183 023614058847	1137183 023614058915	69.99
Skeet	.005"	1134193 023614048473	1135193 023614058786	1136193 023614058854	1137193 023614058922	69.99
Cylinder	.000"	1134113 023614055617	1135113 023614058793	1136113 023614058861	1137113 023614058939	69.99
Extended 12 Ga. Choke Tube T-Wrench	—	1130038 023614204183	—	—	—	19.99

Flat choke tube wrench is not compatible with Diamond Grade choke tubes.



DIANA™ GRADE EXTENDED CHOKE TUBES

STANDARD  
**INVECTOR™**

**INVECTOR-Plus™**



DESCRIPTION	CONSTRUCTION (INCHES)	12 GA. CODE/UPC #	20 GA. CODE/UPC #	28 GA. CODE/UPC # (STD. INVECTOR)	SUGG. RETAIL
Full	.035"	1130553 023614201700	1131053 023614202257	1132153 023614202318	\$59.99
Improved Modified	.025"	1130563 023614201694	1131063 023614202240	1132163 023614202301	59.99
Modified	.020"	1130573 023614201687	1131073 023614202233	1132173 023614202295	59.99
Light Modified	.015"	1130533 023614201670	1131033 023614202226	1132133 023614202288	59.99
Improved Cylinder	.010"	1130583 023614201663	1131083 023614202219	1132183 023614202271	59.99
Skeet	.005"	1130593 023614201656	1131093 023614202202	1132193 023614202264	59.99
Cylinder	.000"	1130513 023614201649	—	—	59.99
Spreader*	—	1130503 023614202530	—	—	79.99
Extended 12 Ga. Choke Tube T-Wrench	—	1130038 023614204183	—	—	19.99

\* Helically rifled to spin the shot charge and spread the pattern.  
Flat choke tube wrench is not compatible with Diana Grade choke tubes.

- Longer choke taper inside Invector-Plus™ choke tubes for use with back-bored barrels on 12 and 20 gauge shotguns
- Stainless steel barstock is heat treated prior to machining
- Titanium nitride surface 72HRC hardness for excellent wear and reduced plastic buildup
- Absolutely perfect concentricity for superior patterning
- Extends beyond the barrel for easy removal and installation
- Browning Diana™ Grade choke tubes produce tighter patterns than Browning Invector-Plus flush choke tubes (28 gauge are Standard Invector™ chokes)

INVECTOR-PLUS™ EXTENDED CHOKE TUBES

**INVECTOR-Plus™**



DESCRIPTION	CONSTRUCTION (INCHES)	CODE/UPC #	SUGG. RETAIL
Full	.035"	1132253 023614048374	\$39.99
Improved Modified	.025"	1132263 023614048381	39.99
Modified	.020"	1132273 023614048398	39.99
Light Modified	.015"	1132233 023614048404	39.99
Improved Cylinder	.010"	1132283 023614048411	39.99
Skeet	.005"	1132293 023614048428	39.99

- Invector-Plus™ extended tubes are constructed of highly polished, 17-4 stainless steel for the ultimate in performance and durability
- Available in constrictions ranging from Skeet to Full
- Knurled portion extends beyond the end of the barrel for easy removal and installation
- Longer choke taper inside Invector-Plus choke tubes for use with back-bored barrels
- Produces excellent patterns with uniform densities
- All Browning tubes are set to industry constriction standards

SPECIALTY EXTENDED CHOKE TUBES

FULL STRUT TURKEY TUBE

- Stainless steel with black oxide finish
- Camo band
- Directional porting
- Designed for optimal performance with #4, #5 and #6 shot
- Threaded for 12 gauge Invector-Plus™ back-bored barrels only

EXPRESS SABOT™ RIFLED CHOKE TUBE

- Stainless steel with black oxide finish
- Rifled design is extremely effective with both sabot and Foster slugs
- Threaded for 12 gauge Invector-Plus™ back-bored barrels only



DESCRIPTION	CONSTRUCTION (INCHES)	CODE #	UPC #	SUGG. RETAIL
Full Strut Turkey	.102"	1130500	023614178897	\$69.99
Express Sabot	—	1130863	023614179719	79.99
Extended 12 Ga. Choke Tube T-Wrench	—	1130038	023614204183	19.99

Flat choke tube wrench is not compatible with specialty choke tubes.



**GOOSE BAND CHOKE TUBES**

- Unique extended design resembles a waterfowl leg band
- 17-4 stainless steel construction
- Superior patterning with steel shot
- Threaded for 12 gauge Invector-Plus™ back-bored barrels only
- Produces tighter patterns than Browning Invector-Plus flush choke tubes
- Friction wrench is designed specifically for Goose Band choke tubes



DESCRIPTION	CONstriction (INCHES)	CODE #	UPC #	SUGG. RETAIL
Full	.035"	1131853	023614063568	\$59.99
Improved Modified	.025"	1131863	023614063575	59.99
Modified	.020"	1131873	023614063582	59.99
Light Modified	.015"	1131833	023614063599	59.99
Improved Cylinder	.010"	1131883	023614063605	59.99
Cylinder	.000"	1131813	023614063612	59.99
12 Ga. Choke Tube Friction Wrench	—	1130080	023614063919	29.99

12 Gauge Friction Wrench



*Flat, T-Wrench, and Speed choke tube wrenches are not compatible with Goose Band choke tubes.*

**GRAND PASSAGE™ EXTENDED CHOKE TUBES**

- Mossy Oak® Duck Blind® camo band
- Stainless steel with black oxide finish
- Superior patterning with steel shot
- Threaded for 12 gauge Invector-Plus™ back-bored barrels only
- Browning Grand Passage extended choke tubes produce tighter patterns than Browning Invector-Plus flush choke tubes
- Timber n' Teal model is helically spun to spin shot, making it excellent for tight timber, teal and close range shooting

DESCRIPTION	CONstriction (INCHES)	CODE/UPC #	SUGG. RETAIL
Full	.035"	1131453 023614048480	\$49.99
Improved Modified	.025"	1131463 023614048497	49.99
Modified	.020"	1131473 023614048503	49.99
Light Modified	.015"	1131433 023614048510	49.99
Improved Cylinder	.010"	1131483 023614048527	49.99
Timber n' Teal*	—	1131493 023614048534	69.99
Extended 12 Ga. Choke Tube T-Wrench	—	1130038 023614204183	19.99



*\* Helically rifled to spin the shot charge and spread the pattern.  
Flat choke tube wrench is not compatible with Grand Passage choke tubes.*

**SNAP CAPS**



DESCRIPTION	CODE #	UPC #	SUGG. RETAIL
Snap Caps — 12 Ga.	12465	023614204152	\$29.99

- Precisely matches the dimensions of live 12 gauge shells
- A safe way to practice trigger pull
- Withstands repeated dry-firing practice
- Will not harm firing pins or chambers
- Sold in pairs



**BUCKMARK HEARING PROTECTOR FOR HER**

**NEW**



- Pink adds a feminine touch
- Unobtrusive low-profile design
- Soft, comfortable foam ear cups
- Foldable padded headband
- NRR 31dB



**BUCKMARK HEARING PROTECTOR**



- Unobtrusive low-profile design
- Soft, comfortable foam ear cups
- Foldable padded headband
- NRR 31dB



**COMPACT HEARING PROTECTOR**

- Ultimate in lightweight comfort
- Weighs nearly 50% less than standard hearing protectors
- Can be folded for easy storage
- NRR 21dB



**MIDAS™ ELECTRONIC HEARING PROTECTOR**

- Sharp noises are reduced while normal speech and sounds are amplified
- On/off volume controls
- Fast reaction time: 6 milliseconds
- Operates on two AA batteries (not included)
- 100-120 hours per set of batteries with LED battery life indicator
- NRR 28dB



Runs on 2 AA Batteries



DESCRIPTION	CODE #	UPC #	SUGG. RETAIL
<b>NEW</b> Buck Mark Hearing Protector For Her	12681	023614370048	\$19.99
Buck Mark Hearing Protector	12680	023614063643	19.99
Compact Hearing Protector	12631	023614245117	24.99
Midas Electronic Hearing Protector	12627	023614048596	69.99



**DELUXE HEARING PROTECTOR**



- Comfortable, extra-wide padded headband
- Adjustable stainless steel wires
- NRR 22dB

DESCRIPTION	CODE #	UPC #	SUGG. RETAIL
Deluxe Hearing Protector	12632	023614245124	\$29.99

**DUAL SHELL HEARING PROTECTOR**



- One of the highest noise reduction ratings of any earmuff
- Unique dual shell design minimizes resonance
- NRR 29dB

DESCRIPTION	CODE #	UPC #	SUGG. RETAIL
Dual Shell Hearing Protector	12633	023614563631	\$34.99

**BROWNING DUO EARPLUGS**



- Insert yellow end for variable level protection, such as at outdoor ranges
- Use olive end for a constant NRR of 22dB for indoor ranges
- Selected for use by U.S. military and NATO

DESCRIPTION	CODE #	UPC #	SUGG. RETAIL
Browning Duo Earplugs	12640	023614181842	\$19.99

**LOW PROFILE HEARING PROTECTOR**



- Lightweight and compact
- Fits comfortably behind the head for use with a hat
- NRR 19dB

DESCRIPTION	CODE #	UPC #	SUGG. RETAIL
Low Profile Hearing Protector	12630	023614179016	\$24.99

**RANGE KITS**

**RANGE KIT:**

- Shooting glasses with orange tinted polycarbonate lenses offer both eye protection and enhanced target visibility
- Soft foam earplugs provide noise reduction up to 31dB and come with a plastic storage case (shown)
- Adjustable-fit earmuffs with padded headband have a noise reduction rating of 27dB

**FOR HER RANGE KIT:**

- Buck Mark shooting glasses with smoke polycarbonate lenses and light pink frames offer eye protection and enhanced target visibility in bright conditions
- Pink soft foam earplugs provide noise reduction up to 31dB and come with a plastic storage case
- Adjustable-fit For Her earmuffs with padded headband have a noise reduction rating of 31dB



DESCRIPTION	CODE #	UPC #	SUGG. RETAIL
<b>NEW</b> Range Kit For Her	126369	023614370055	\$29.99
Range Kit	126368	023614038009	29.99



**MAXUS® POLARIZED HUNTING GLASSES**

- Tri-Acetate Cellulose (TAC) polarized lenses reduce glare and minimize distortion to eliminate eye strain and improve vision
- Grilamid frame is durable and flexible for all-day comfort and feature a buoyant foam core that keeps glasses afloat to prevent loss when fishing or hunting
- Megol nose and temple pads provide a secure fit and resist slipping caused by perspiration or sunscreen



Black/Smoke Lens



Mossy Oak® Duck Blind®/Copper Lens

DESCRIPTION	CODE #	UPC #	SUGG. RETAIL
Maxus Glasses, Black/Smoke	12731	023614063650	\$39.99
Maxus Glasses, Black/Copper	12732	023614063667	39.99
Maxus Glasses, MODB/Smoke	12741	023614063674	39.99
Maxus Glasses, MODB/Copper	12742	023614063681	39.99

**CLAYMASTER™ SHOOTING GLASSES**

- High-grade polycarbonate lenses offer 99% UV protection
- Interchangeable orange, yellow, clear, smoke and blue colored lenses included
- Fully adjustable frames include ratchet pitch adjustment, expandable temple length and height adjustable nose pads
- Padded case and microfiber bag are included (not shown)



DESCRIPTION	CODE #	UPC #	SUGG. RETAIL
Claymaster Shooting Glasses	12715	023614038269	\$39.99



**ACE SHOOTING GLASSES**

- High-grade polycarbonate lenses offer 99% UV protection
- Interchangeable vermilion, orange and yellow colored lenses included
- Lightweight frames
- Rubberized nose and temple pads
- Microfiber bag is included (not shown)

DESCRIPTION	CODE #	UPC #	SUGG. RETAIL
Ace Shooting Glasses	12717	023614038276	\$29.99

**BUCKMARK SHOOTING GLASSES**



- Suspended lens offers an unobstructed view, maximum protection, stylish looks and 99% UV protection
- Wrap-around polycarbonate lens offers side protection
- Frames include ratcheted pitch adjustment
- Non-slip three position adjustable nosepiece
- Rugged polycarbonate frame with non-slip temples
- Microfiber bag included (not shown)
- Available with choice of clear, orange or smoke lenses
- For Her style includes pink frame and smoke lenses

DESCRIPTION	CODE #	UPC #	SUGG. RETAIL
<b>NEW</b> Buck Mark Shooting Glasses, For Her	12721	023614369400	\$19.99
Buck Mark Shooting Glasses, Clear	12718	023614061953	19.99
Buck Mark Shooting Glasses, Smoke	12719	023614061960	19.99
Buck Mark Shooting Glasses, Orange	12720	023614061977	19.99



**GUN CLEANING MAT**



- The safe way to protect both firearms and furniture
- Soft, felt-like fabric won't damage firearms
- Waterproof Zorb Tech™ backing stops spills from migrating and inhibits the soak-through of cleaners
- Mat measures 16" x 54" for plenty of room while keeping small parts in their places and organized
- Washable, dryable, highly stain-resistant

DESCRIPTION	DIMENSIONS	CODE #	UPC #	SUGG. RETAIL
Gun Cleaning Mat	16" x 54"	12420	023614180265	\$19.99

**UNIVERSAL CLEANING KIT**

- 35-piece kit is packaged in a fitted aluminum frame carry case with handle and contains two sets of solid brass cleaning rods: One for small caliber rifles and pistols (.17-.280) and one for large caliber rifles, pistols (.30 and larger) and shotguns
- Ten wire brushes, .17-.45 cal. including three shotgun brushes 12 ga., 20 ga., and .410 bore
- Six wool mops from .17 cal. -12 gauge
- Includes six jags, two slotted patch holders, brush adaptors, one PSH handle, handle adaptor and 50 cleaning patches



DESCRIPTION	CODE #	UPC #	SUGG. RETAIL
Universal Cleaning Kit	12444	023614048640	\$49.99

**CARBON REMOVER, BORE POLISH, SOLVENT AND DEGREASER, GUN OIL**

**1 ▶ STEP 1 CARBON REMOVER**

- Proprietary formula quickly removes carbon build up
- Evaporates quickly
- Contains no ammonia, pH neutral
- Pinpoint applicator
- 4 oz. bottle

**2 ▶ STEP 2 BORE POLISH**

- Proprietary formula improves bore condition while safely removing accuracy-harming copper build up
- Removes copper, lead and powder residue
- Evaporates quickly
- Contains no ammonia, pH neutral
- Pinpoint applicator
- 4 oz. bottle

**3 ▶ STEP 3 SOLVENT AND DEGREASER**

- Safely removes residue from Carbon and Bore Polish cleaners
- Fast-drying solvent displaces water
- Contains no chlorine, ozone safe
- Rapidly cuts through oil and grease
- Leaves no residue
- 19 oz. aerosol can

**4, 5 ▶ STEP 4 GUN OIL**

- Proprietary formula passes strict military requirements
- Low surface tension provides excellent lubrication and corrosion protection
- Contains no synthetics
- Pinpoint applicator on 2 oz. bottle
- 6 oz. aerosol can

**6 ▶ PRE-PACKAGED 4-STEP GUN CLEANER**

- Includes Carbon Cleaner, Bore Polish, 10 oz. Solvent Degreaser and Gun Oil



DESCRIPTION	SIZE	CODE #	UPC #	SUGG. RETAIL
1 ▶ Step 1 Carbon Remover, 4 oz. Applicator	4 oz.	124023	023614048602	\$9.99
2 ▶ Step 2 Bore Polish, 4 oz. Applicator	4 oz.	124024	023614048619	12.99
3 ▶ Step 3 Solvent and Degreaser, 19 oz. Aerosol	19 oz.	124025	023614048626	9.99
4 ▶ Step 4 Gun Oil, 2 oz. Applicator	2 oz.	124032	023614048633	7.99
5 ▶ Step 4 Gun Oil, 6 oz. Aerosol	6 oz.	124040	023614059066	12.99
6 ▶ Prepack 4-Step Gun Cleaner	—	123400	023614055686	39.99



**KNIVES INDEX****CAMPING KNIVES**

Backcountry . . . . .	170
Campmate Knife . . . . .	173
Camp Saws . . . . .	173

**COLLECTIBLE KNIVES**

Crowell/Barker Competition . . . . .	170
Presentation Lockback . . . . .	171
Scrimshaw . . . . .	158
Whitetail Legacy . . . . .	157

**HUNTING AND FISHING KNIVES**

Backcountry . . . . .	170
Backtrack Folders . . . . .	168
Big Game Series . . . . .	163
Big Game Stag . . . . .	163
Browning 111 Folding . . . . .	168
Classic Series . . . . .	162
Escalade Series . . . . .	160
Extreme Mountain Hunter . . . . .	164
For Her Series . . . . .	156
Guide's Choice . . . . .	160
Hard Core Hunter Combos . . . . .	159
Independence . . . . .	155
Kodiak F.D.T. . . . .	167
Lil' Bit . . . . .	165
Obsession Series . . . . .	167
Outdoorsman Fillet . . . . .	161
Packer . . . . .	166
Tactical Hunter Series . . . . .	163
Woodsmen Bird and Trout . . . . .	161

**KITCHEN KNIVES**

Outdoorsman Kitchen Cutlery Set . . . . .	172
Outdoorsman Steak Knives . . . . .	172

**POCKET KNIVES**

Backdraft Assisted Opening . . . . .	158
Chinook . . . . .	172
Classic Series Folding . . . . .	162
Fast Task Series . . . . .	171
Gunstock Series . . . . .	171
Mountain Ti . . . . .	169
Prism II . . . . .	169

# KNIVES

**KNIVES — ESSENTIAL TOOLS**

The knife is one of the oldest, most basic of tools and can be used for a variety of chores.

Whether hunting, backpacking, fishing or working at home, keeping a sharp knife handy should be essential. We offer a wide selection of blades to meet nearly every use you can imagine. From dressing big game to cleaning a fish to slicing an apple, Browning has the knife you want.

*Backcountry Camp Knife, page 170*



**NEW**

**INDEPENDENCE KNIVES**

There was a time in the not so distant past when nearly everything you purchased was built in America, and the term Made in the USA stood for the highest quality. Made in the USA still means something special to many people, and that is why we are proud to offer the new Independence knife series. This collection was designed in the USA by famed knifemaker Russ Kommer. All the materials are sourced from

American companies, and the knives themselves are also built in the USA. Their quality is evident from first glance. Functional designs have been tried and tested in real-world hunting situations to make certain their balance is perfect and their blades stay sharp. Get your hands on a new Independence Series knife and take a bit of homegrown Browning quality into the field on your next hunting trip.



**RUSS KOMMER**

For nearly 30 years Russ Kommer has earned his living as a highly respected big game hunting guide in Idaho and the wilds of Alaska. The work of a guide doesn't end with leading clients to trophy game animals, it starts there. Once an animal is on the ground the real work begins. Over the years Russ used many knives to dress and skin countless animals, yet found each knife lacking in performance. He drew upon his wealth of hands-on experience and started designing and producing his own knives. It turned out that Russ had a knack for this art and has become a talented, award-winning knifemaker. What started as a hobby and the search for a better blade has led to numerous best-in-show awards. Russ creates and personally field tests his designs to ensure they meet the toughest standards — his own. Browning is honored to team with Russ to produce many of the knives throughout this catalog.

**SERIES FEATURES**

- TYPE** - Fixed and folding button-lock knives
- BLADES** - USA 154 CM stainless steel
- HANDLES** - Fixed blades: G-10 · Folders: G-10, carbon fiber
- FEATURES** - Fixed-blade models include a Made in USA top-grain leather sheath
- Folders include a pocket clip

MODEL	DESCRIPTION	BLADE LENGTH	CODE #	UPC #	SUGG. RETAIL
741	<b>NEW</b> Independence Folder, Black G-10	3 3/4"	322741	023614083061	\$129.95
742	<b>NEW</b> Independence Folder, Digital Camo G-10	3 3/4"	322742	023614083078	129.95
743	<b>NEW</b> Independence Folder, Carbon Fiber	3 3/4"	322743	023614083092	199.95
744	<b>NEW</b> Independence Fixed Blade, Black/Green G-10	3 3/4"	322744	023614085256	99.95
745	<b>NEW</b> Independence Fixed Blade, Olive Drab G-10	3 3/4"	322745	023614085263	99.95
746	<b>NEW</b> Independence Fixed Blade, Blaze G-10	3 3/4"	322746	023614085270	99.95



BROWNING FOR HER KNIVES

**NEW**

With perfectly-balanced blades, handles with smaller dimensions and designs that might even be called “cute,” new Browning For Her knives are designed for women who take the outdoors as seriously as men do. If pink isn't your thing, a bone handle is also available. All knives feature a rugged nylon sheath and the folders also include a handy pocket clip.

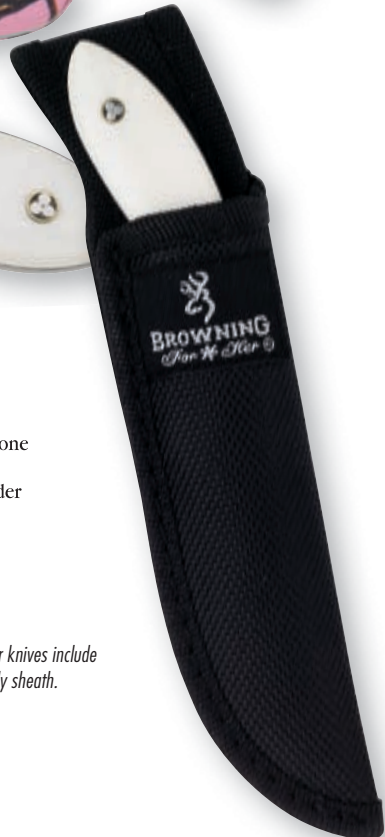

SERIES FEATURES

- TYPE - Fixed blade or folding locking liner
- BLADE - Swedish Sandvik® 12C27 stainless steel
- HANDLE - Aluminum with Dura-Touch® Armor Coating or genuine bone with mosaic pins (fixed blade only) · Stainless steel bolsters
- FEATURES - Fixed blade models include a rugged nylon sheath · Folder comes with a rugged nylon sheath and pocket clip



*For Her knives include a handy sheath.*

MODEL	DESCRIPTION	BLADE	CODE #	UPC #	SUGG. RETAIL
894	<b>NEW</b> Browning For Her, Folder, Mossy Oak Pink	2¾"	322894	023614085133	\$24.95
895	<b>NEW</b> Browning For Her, Folder, Bone	2¾"	322895	023614085140	24.95
892	<b>NEW</b> Browning For Her, Fixed Blade, Mossy Oak Pink	2⅞"	322892	023614085119	34.95
893	<b>NEW</b> Browning For Her, Fixed Blade, Bone	2⅞"	322893	023614085126	34.95



WHITETAIL LEGACY KNIVES

This special Whitetail Legacy Limited Edition presentation-grade knife honors the cagey whitetail deer and makes an excellent gift for the dedicated hunters who pursue them. The handsome handles are shaped from exquisite mesquite burl and feature pronounced finger grooves for a secure grip. Highly polished, the drop point, semi-skinner blade is hollow ground and carefully crafted from high-quality

Swedish Sandvik® steel. The full-length tang is tapered to provide perfect balance. Polished bolsters dovetail neatly. A whitetail deer lithograph is included and suitable for framing. This deluxe limited edition knife includes a felt-lined, hand-crafted walnut presentation box for display. Only 3,000 of the Whitetail Legacy Limited Editions will be made, so get yours today.



Frame not included



247



WHITETAIL LEGACY LIMITED EDITION KNIFE

MODEL	DESCRIPTION	BLADE	CODE #	UPC #	SUGG. RETAIL
247	Whitetail Legacy Limited Edition	3 3/4"	322247	023614075356	\$250.00

SERIES FEATURES

**TYPE** - Fixed blade  
**BLADE** - Swedish Sandvik® 12C27 stainless steel  
**HANDLE** - Mesquite burl  
**FEATURES** - Limited Edition knife includes walnut presentation box and lithograph



248



249

Without question, the whitetail deer is the most popular big game species in North America. To honor them, we offer the Whitetail Legacy series knives. Don't let their beauty fool you, these rugged knives have been extensively field tested by Alaskan guides and Midwestern bowhunters and used for every task imaginable. The unique mesquite burl handles offer natural beauty with a warm texture and exceptional durability. Hollow ground blades are razor sharp and an ideal length for field dressing.

WHITETAIL LEGACY KNIVES

SERIES FEATURES

**TYPE** - Fixed blade or folding locking liner  
**BLADE** - Fixed blade: Swedish Sandvik® 12C27 stainless steel · Folder: 440C stainless steel  
**HANDLE** - Mesquite burl  
**FEATURES** - Fixed blade model includes a top-grain deluxe leather sheath · Folder comes with a pocket clip

MODEL	DESCRIPTION	BLADE	CODE #	UPC #	SUGG. RETAIL
248	Whitetail Fixed Blade	3 3/4"	322248	023614075363	\$99.95
249	Whitetail Folder	3 3/4"	322249	023614076919	99.95



**BACKDRAFT ASSISTED OPENING KNIVES**

Comfortably clipped to your pocket, handy Browning Backdraft Assisted Opening knives are quick into action with a flip of your thumb. A unique manual locking system retains the blade in the closed position until called upon. Backdraft knives feature 6061 T6 aircraft grade anodized aluminum scales for a rock-solid feel and stylish appearance. Carry a Backdraft knife for a ready and reliable blade.



MODEL	DESCRIPTION	BLADE LENGTH	CODE #	UPC #	SUGG. RETAIL
355	Backdraft, Silver/Blue	3 1/4"	322355	023614076940	\$99.95
356	Backdraft, Silver/Black	3 1/4"	322356	023614076988	99.95

**SERIES FEATURES**

**TYPE** - Folding locking liner · Assisted opening  
**BLADES** - 420 stainless steel  
**HANDLES** - 6061 T6 aircraft grade anodized aluminum

**SCRIMSHAW KNIVES**



MODEL	DESCRIPTION	BLADE LENGTH	CODE #	UPC #	SUGG. RETAIL
540	Scrimshaw Whitetail	2 7/8"	322540	023614040804	\$59.95
541	Scrimshaw Mule Deer	2 7/8"	322541	023614040811	59.95
542	Scrimshaw Elk	2 7/8"	322542	023614040828	59.95
543	Scrimshaw Mallard	2 7/8"	322543	023614041665	59.95
544	Scrimshaw Pheasant	2 7/8"	322544	023614041672	59.95
545	Scrimshaw Turkey	2 7/8"	322545	023614041689	59.95
547	Scrimshaw Lab	2 7/8"	322547	023614075233	59.95

Long ago, when ships with sails ruled the waves, ivory carving was a popular hobby for sailors who spent months at sea with little to do except swab decks. While not carved from real ivory, Browning Scrimshaw knives feature richly detailed game scenes skillfully crafted into replica handles.

**SERIES FEATURES**

**TYPE** - Folding lockbacks  
**BLADES** - Hollow ground, satin-finished 420-J2 stainless steel · Laser-engraved Buckmark logo  
**HANDLES** - Finely polished zinc casting for heft and balance · Laser-engraved Buckmark logo · Adorned with scrimshaw wildlife artwork  
**FEATURES** - Brush finished back with Browning logo



HARD CORE HUNTER COMBOS



437  
Black Combo



★ *Designed  
in the USA  
by  
Russ Kommer*



438  
Mossy Oak®  
New Break-Up® Combo



Years of extensive field research have culminated with the ultimate three-piece hunting set, the Hard Core Hunter. Demanding hunters are sure to appreciate the hand saw with its 4¾" high carbon steel push/pull blade that makes fast work of wood or game. The custom handle shape minimizes hand fatigue. The knife has a semi-skinner drop point main blade and a unique canoe-shape handle with Dura-Touch® Armor Coating for complete comfort and control. A small caping knife offers precision for delicate field chores from capping a hide to peeling an apple. All blades fit into a slim, one-of-a-kind compact carry system with a unique swivel belt clip that makes the saw and knives easily accessible.

**SERIES FEATURES**

**TYPE** - Fixed blades

**BLADES** - German X50CrMoV15 steel

**HANDLES** - Contour-molded composite

**FEATURES** - Nylon sheath that easily fits all three pieces

MODEL	DESCRIPTION	BLADE LENGTH	CODE #	UPC #	SUGG. RETAIL
437	Hard Core Hunter Combo, Black	Drop Point: 3½" Caper: 2¾" Saw: 4¾"	322437	023614081340	\$69.95
438	Hard Core Hunter Combo, MONBU	Drop Point: 3½" Caper: 2¾" Saw: 4¾"	322438	023614081364	79.95



GUIDE'S CHOICE KNIVES

**NEW**

Straight from the demands of hunters comes the new Guide's Choice knives. These sleek pairs are constructed from tough Sandvik® 12C27 stainless steel. The modified drop point style blade of the larger knife is ideal for general field dressing, while the smaller caping knife makes skinning easier and more precise than ever. Full-length tangs afford impeccable balance and strength. Canoe-shaped handles with finger grooves give ample grip. When a single knife just won't do the job, reach for the Guide's Choice.



Nylon sheath included with Model 521.

**Designed in the USA by Russ Kommer**

MODEL	DESCRIPTION	BLADE LENGTH	CODE #	UPC #	SUGG. RETAIL
521	<b>NEW</b> Guide's Choice, Fixed Blade, G-10	3½" 2¾"	322521	023614085164	\$49.95
523	<b>NEW</b> Guide's Choice, Fixed Blade, Stag	3½" 2¾"	322523	023614085157	99.95

SERIES FEATURES

TYPE - Fixed blades

BLADES - Swedish Sandvik® 12C27 stainless steel

HANDLES - Stag or G-10

FEATURES - Stag handled fixed-blade models include a top-grain leather sheath · G-10 handled models include a Cordura® nylon sheath

ESCALADE SERIES KNIVES



Fixed-blade Escalade knives include a heavy duty, top-grain leather sheath.

**Designed in the USA by Russ Kommer**

SERIES FEATURES

TYPE - Fixed blade and folding liner lock

BLADES - Swedish Sandvik® 12C27 stainless steel on fixed blades · 440-C stainless steel on folders

HANDLES - USA box elder burl

FEATURES - Fixed-blade models include a top-grain leather sheath · Folding models include a pocket clip

MODEL	DESCRIPTION	BLADE LENGTH	CODE #	UPC #	SUGG. RETAIL
662	Escalade Series, Fixed Blade Skinner, Brown Box Elder Burl	2½"	322662	023614041917	\$69.95
663	Escalade Series, Fixed Blade Drop Point, Gray Box Elder Burl	3½"	322663	023614041924	79.95
664	Escalade Series, Fixed Blade Drop Point, Brown Box Elder Burl	3¾"	322664	023614041948	79.95
667	Escalade Series, Large Folding Skinner, Brown Box Elder Burl	3"	322667	023614074656	89.95
668	Escalade Series, Medium Folding Skinner, Red/Black Box Elder Burl	2¾"	322668	023614074755	79.95



**OUTDOORSMAN FILLET KNIVES**

While a skilled individual can properly fillet a fish with most any knife, the rest of us require the aid of a sharp, flexible fillet knife. Browning Outdoorsman fillet knives are made to easily cut fillets with veteran-like ease. The razor-sharp German X50CrMoV15

steel blade provides just the amount of flex and feedback needed to glide over bones and carve perfect fillets every time. Tough, canoe-shaped molded handles provide a secure non-slip grip even when wet, for added control.



**SERIES FEATURES**

- TYPE - Fixed blade fillet
- BLADES - German X50CrMoV15 steel
- HANDLES - Durable injection molded handles with inlaid metal Buckmark
- FEATURES - Nylon sheath included

MODEL	DESCRIPTION	BLADE LENGTH	CODE #/ UPC #	SUGG. RETAIL
483	Outdoorsman Fillet, Black	7¼"	322483 023614078647	\$29.95
484	Outdoorsman Fillet, Yellow	7¼"	322484 023614078807	29.95

**WOODSMAN BIRD AND TROUT KNIVES**



MODEL	DESCRIPTION	BLADE LENGTH	CODE #/ UPC #	SUGG. RETAIL
326	Woodsmen Bird and Trout, Black laminate	3½"	322326 023614078203	\$79.95
327	Woodsmen Bird and Trout, MODB laminate	3½"	322327 023614078210	59.95

**SERIES FEATURES**

- TYPE - Fixed blade
- BLADES - Swedish Sandvik® 12C27 stainless steel
- HANDLES - 326: Black laminate · 327: MODB camo laminate
- FEATURES - 326: Top-grain leather sheath · 327: Ballistic Cloth™ nylon sheath

Incredibly versatile, Browning's Woodsmen Bird and Trout knives are ideal for wingshooters and fishermen alike. The unique blade shape offers superb balance and ease of handling that enables intricate cuts in tight places like wing joints. Choose from a resin-impregnated

linen handle with mirror-polished blade and bolsters or a utilitarian Mossy Oak® Duck Blind® handle with satin-finished blade for comfort and sure control. Sandvik® 12C27 stainless steel is used in the blade production.



CLASSIC SERIES KNIVES



416



417



418



419



NEW

366



NEW

367



NEW

368



NEW

369



334



335



336



337

MODEL	DESCRIPTION	BLADE LENGTH	CODE #	UPC #	SUGG. RETAIL
416	<b>NEW</b> Stainless, Fixed Blade	3"	322416	023614085096	\$39.95
417	<b>NEW</b> Wood, Fixed Blade	3"	322417	023614085089	39.95
418	<b>NEW</b> Stag, Fixed Blade	3"	322418	023614085065	49.95
419	<b>NEW</b> Mother-of-Pearl, Fixed Blade	3"	322419	023614085072	49.95
366	<b>NEW</b> Stainless, Medium Folder	2½"	322366	023614085058	19.95
367	<b>NEW</b> Wood, Medium Folder	2½"	322367	023614085041	19.95
368	<b>NEW</b> Stag, Medium Folder	2½"	322368	023614083139	29.95
369	<b>NEW</b> Mother-of-Pearl, Medium Folder	2½"	322369	023614084525	29.95
334	Stainless, Small Folder	1¾"	322334	023614074816	14.95
335	Wood, Small Folder	1¾"	322335	023614074830	14.95
336	Stag, Small Folder	1¾"	322336	023614074878	19.95
337	Mother-of-Pearl, Small Folder	1¾"	322337	023614075189	19.95

Knives similar to the Classic Series first appeared way back in the 1969 Browning catalog. Today's Classic Series knives have all the features, and more, that made the original models so prized. Razor sharp blades are fancy scroll etched and embellished with a gold Buckmark. Precision construction means the blade locks open with a snap. Folding models are thin enough to hardly notice in a pocket or purse, and make excellent gifts. Select from a variety of handle materials including stainless, wood, stag or mother-of-pearl scales. Leather sheath included with fixed blade models.

SERIES FEATURES

**TYPE** - Fixed blade and folding lockbacks

**BLADES** - 5CR15MOV stainless steel with engraving

**HANDLES** - Stainless, Wood, Stag or Mother-of-Pearl

**FEATURES** - Ultra-thin construction slides easily into pocket without adding excess bulk · Unique blade etching with Buckmark sets these knives apart · Fixed blade models include a leather sheath



**BIG GAME STAG HUNTING KNIFE**



525

The warm feel of a stag-handled knife in your hand is as traditional as it gets. This finely-crafted, fixed blade knife has a genuine stag handle with canoe shape and finger grooves for excellent grip. Razor-sharp 440-A stainless steel blade. High-polished stainless bolsters feature a finger guard and a lasered Buckmark. Top grain leather tie and sheath included.

**SERIES FEATURES**

- TYPE - Fixed blade
- BLADE - 440-A stainless steel
- HANDLE - Stag
- FEATURES - Includes a top-grain leather sheath



525 with Leather Sheath

MODEL	DESCRIPTION	BLADE LENGTH	CODE #/ UPC #	SUGG. RETAIL
525	Stag Fixed Blade	4¼"	322525 023614041849	\$119.95

**BIG GAME SERIES KNIVES**

**SERIES FEATURES**

- TYPE - Folding lockback
- BLADES - AUS-8A stainless steel
  - Versatile push/pull hide-cutter blade
  - Serrated saw blade
- HANDLES - 828: Zytel® with laminated wood inserts · 524: Stag scales and brass bolsters
- FEATURES - 828: Ballistic Cloth™ nylon sheath · 524: Top-grain leather sheath



524

828

MODEL	DESCRIPTION	BLADE LENGTH	CODE #/ UPC #	SUGG. RETAIL
828	Featherweight Big Game II	3¾"	322828 023614567080	\$79.95
524	Stag Big Game II	3¾"	322524 023614567066	149.95

**TACTICAL HUNTER SERIES KNIVES**

The new Tactical Hunter Series knives offer a unique addition to every outdoorsman's arsenal. Precision crafted, these high-quality knives feature a unique flipper design that assists in the speedy opening of the knife, and doubles as a finger guard when the blade is extended. The VG-10 stainless steel drop point blade is of the highest quality and holds an incredible edge. Lightweight, durable, corrosion-resistant titanium bolsters and liners. The attached pocket clip keeps the knife secure and easy to locate.



503

504

**NEW**

**SERIES FEATURES**

- TYPE - Folding liner lock with flipper and stainless steel thumbstud
- BLADES - Japanese VG-10 stainless steel
- HANDLES - 503: 6061 aircraft-grade aluminum with Mossy Oak® Break-Up® Infinity™ camo · 504: Black G-10
- FEATURES - Pocket clip

MODEL	DESCRIPTION	BLADE LENGTH	CODE #/ UPC #	SUGG. RETAIL
503	<b>NEW</b> Tactical Hunter, MOINF	3¾"	322503 023614085232	\$59.95
504	<b>NEW</b> Tactical Hunter, Black G-10	3¾"	322504 023614085249	59.95





**EXTREME MOUNTAIN HUNTER KNIVES**

Extreme Mountain Hunter knives are designed for performance and reliability in extreme conditions and circumstances. With no scales to break or come loose part way through a job, the handles provide a secure grip with comfortable, rounded edges and are easy to clean after dressing game. Four models include two different sized drop point blades, one with a modified drop point and one with a deep belly,

semi-skinner shape. Each knife is built from tough Sandvik® 12C27 stainless steel with a Rockwell hardness of 58c-59c for the razor-sharp, edge-holding ability hunters demand. Each knife comes complete with a lightweight, injection molded sheath that complements the knives' rugged, no-nonsense construction. If you push yourself and your gear to the limit, an Extreme Mountain Hunter is your knife.



465



466



467



468

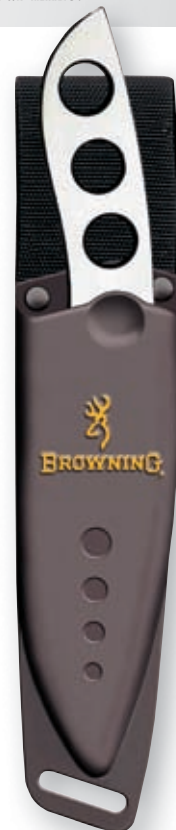

466 with Molded Sheath

MODEL	DESCRIPTION	BLADE LENGTH	CODE #	UPC #	SUGG. RETAIL
465	Large Drop Point	2¾"	322465	023614078388	\$49.95
466	Medium Drop Point	2½"	322466	023614078395	49.95
467	Modified Drop Point	2½"	322467	023614078401	49.95
468	Semi-Skinner	2½"	322468	023614078418	49.95

**SERIES FEATURES**

- TYPE** - Fixed blade extreme
- BLADES** - Teflon® coated Sandvik® 12C27 stainless steel
- HANDLES** - Stainless steel skeleton frame
- FEATURES** - Injection molded quick-release sheath with Ballistic Cloth® nylon backing



LIL' BIT KNIVES



Lil' Bit

Logo detail



SERIES FEATURES

- TYPE - Fixed blade and folding lockback
- BLADES - Sandvik® 12C27 stainless steel
- HANDLES - Genuine stag or exotic desert ironwood
- FEATURES - Top grain leather sheath included · Leather tie

Don't be fooled by the name because these knives are big on performance. Lil' Bit series knives are a tried and true drop point blade design cut from Swedish Sandvik® 12C27 stainless steel that is renowned for superior edge holding ability. Ideally balanced to minimize hand fatigue, Lil' Bit knives are available with genuine stag or desert ironwood, a rare and beautiful exotic wood that resists wear and has a unique grain. All of the Lil' Bit knives come with a top grain leather tie and sheath (shown at right).



Fixed Blade Leather Sheath

MODEL	DESCRIPTION	BLADE LENGTH	CODE #	UPC #	SUGG. RETAIL
790	Lil' Bit Stag Small	2¼"	322790	023614081166	\$49.95
791	Lil' Bit Desert Ironwood Small	2¼"	322791	023614081180	49.95
792	Lil' Bit Stag Large	3¼"	322792	023614081227	59.95
793	Lil' Bit Desert Ironwood Large	3¼"	322793	023614081241	59.95
794	Lil' Bit Folder Stag	2½"	322794	023614081265	44.95
795	Lil' Bit Folder Desert Ironwood	2½"	322795	023614081302	44.95



PACKER SERIES KNIVES

SERIES FEATURES

TYPE - Fixed blade

BLADES - Sandvik® 12C27 stainless steel

HANDLES - Genuine stag or highly grained burl wood

FEATURES - Top-grain sheath included with stag models · Nylon sheath included with RMEF models

Designed by experienced guide and knifemaker Russ Kommer, Packer Series knives were conceived on the unforgiving frontiers of Alaska. The unique handle design and blade shapes maximize the cut efficiency and reduce wrist fatigue. Packers come in three different blade designs: A multi-use modified drop point, a big belly semi-skinner and a modified drop point with a guthook. The knives feature genuine stag handles and a beautiful leather sheath. Browning has also teamed up with the Rocky Mountain Elk Foundation to offer knives with highly figured burl handles and a laser engraved RMEF logo on the bolsters, along with a nylon sheath.



MODEL	DESCRIPTION	BLADE LENGTH	CODE #	UPC #	SUGG. RETAIL
783	Packer Stag	2½"	322783	023614081388	\$69.95
784	Packer Stag Semi-Skinner	3½"	322784	023614081401	69.95
785	Packer Stag with Guthook	3½"	322785	023614081432	69.95
780	Packer RMEF Burl Wood	2½"	322780	023614081449	39.95
781	Packer RMEF Burl Wood Semi-Skinner	3½"	322781	023614081456	39.95
782	Packer RMEF Burl Wood with Guthook	3½"	322782	023614081487	39.95





OBSESSION SERIES KNIVES

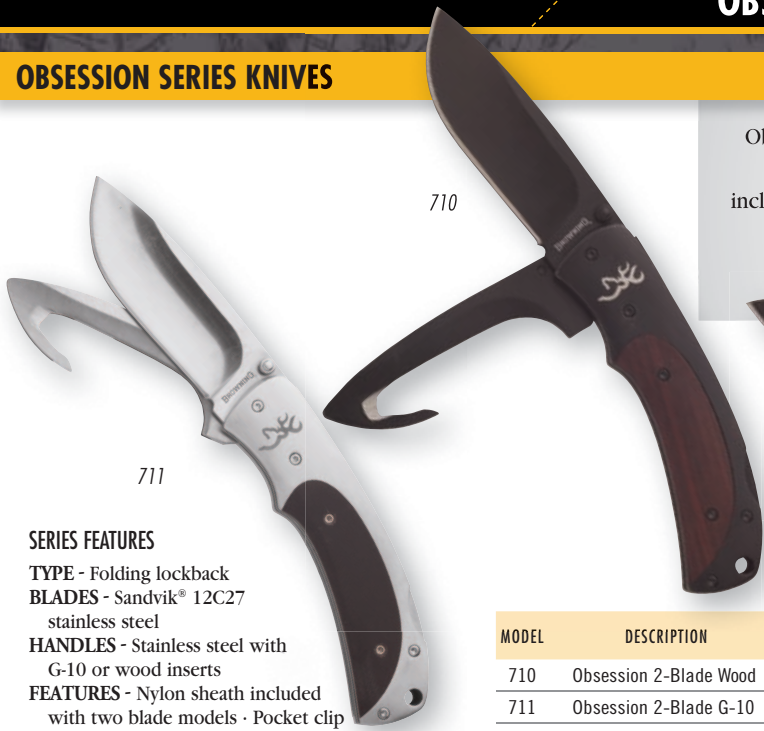

Obsession knives give hunters the perfect tool for dressing and skinning duties. The main blade is a drop point design, and twin-blade models include the best guthook blade ever. The guthook's long throat efficiently funnels the hide without puncturing the rumen.



SERIES FEATURES

**TYPE** - Folding lockback

**BLADES** - Sandvik® 12C27 stainless steel

**HANDLES** - Stainless steel with G-10 or wood inserts

**FEATURES** - Nylon sheath included with two blade models · Pocket clip with single blade models

MODEL	DESCRIPTION	BLADE LENGTH	CODE #	UPC #	SUGG. RETAIL
710	Obsession 2-Blade Wood	3¼"	322710	023614081067	\$39.95
711	Obsession 2-Blade G-10	3¼"	322711	023614081104	39.95
712	Obsession 1-Blade Wood	3¼"	322712	023614081128	29.95
713	Obsession 1-Blade G-10	3¼"	322713	023614081142	29.95

KODIAK F.D.T. KNIVES (FIELD DRESSING TOOLS)



SERIES FEATURES

**TYPE** - Folding lockback

**BLADES** - AUS-8A stainless steel

**HANDLES** - Impact-resistant Zytel® with checkered rubber inlays

**FEATURES** - Ballistic Cloth™ nylon sheath included (not shown)

One of the most popular Browning knives of all time, the name Kodiak stands for toughness and durability, and like their namesake, these knives also know how to take an animal apart. These awesome field dressing tools are available in two styles with one sure to please every hunter. All feature heavy-duty Zytel® handles with non-slip rubber inlays and edge-holding AUS-8A stainless blades. Main blades open quickly with one hand and saw blades are easily replaced.

MODEL	DESCRIPTION	BLADE LENGTH	CODE # / UPC #	UNIQUE FEATURES	SUGG. RETAIL
600	Kodiak F.D.T., Black, Drop Point/Saw/Hide-Cutter	3½"	322600 / 023614567158	<b>Type:</b> Folding lockback (all three blades lock) <b>Blades:</b> Drop point, saw, hide-cutter Saw blade is replaceable	\$79.95
640	Kodiak F.D.T., MOBU, Drop Point/Saw/Hide-Cutter	3½"	322640 / 023614110613	<b>Type:</b> Folding lockback (all three blades lock) <b>Blades:</b> Drop point, saw, hide-cutter Saw blade is replaceable	89.95
60B	Kodiak F.D.T. Blade	3½"	32360B / 023614567165	Replacement saw blade for Models 600, 640	17.75

640

The push/pull hide-cutter blade reduces the risk of puncturing the rumen or other organs during field dressing.





**BROWNING 111 FOLDING KNIVES**

The Buck stops here! Designed by Russ Kommer, the Browning 111 lockbacks improve upon a popular folding design with a finger-grooved, canoe handle constructed from rugged G-10 or cocobolo wood. Hefty bolsters add to the beauty and balance. Modern materials and design ensure the Model 111 knives are one up on the “competition.”



**SERIES FEATURES**

- TYPE - Folding lockback
- BLADES - Sandvik® 12C27 stainless steel
- HANDLES - 111D: G-10 scales and stainless bolsters
- 111C: Cocobolo scales and white brass bolsters
- FEATURES - Nylon sheath included (not shown)
- Spine is stamped “Morgan, Utah”

MODEL	DESCRIPTION	BLADE LENGTH	CODE #	UPC #	SUGG. RETAIL
111D	Black G-10	3¾"	322111D	023614081685	\$34.95
111C	Cocobolo	3¾"	322111C	023614081739	34.95

**BACKTRACK FOLDERS**

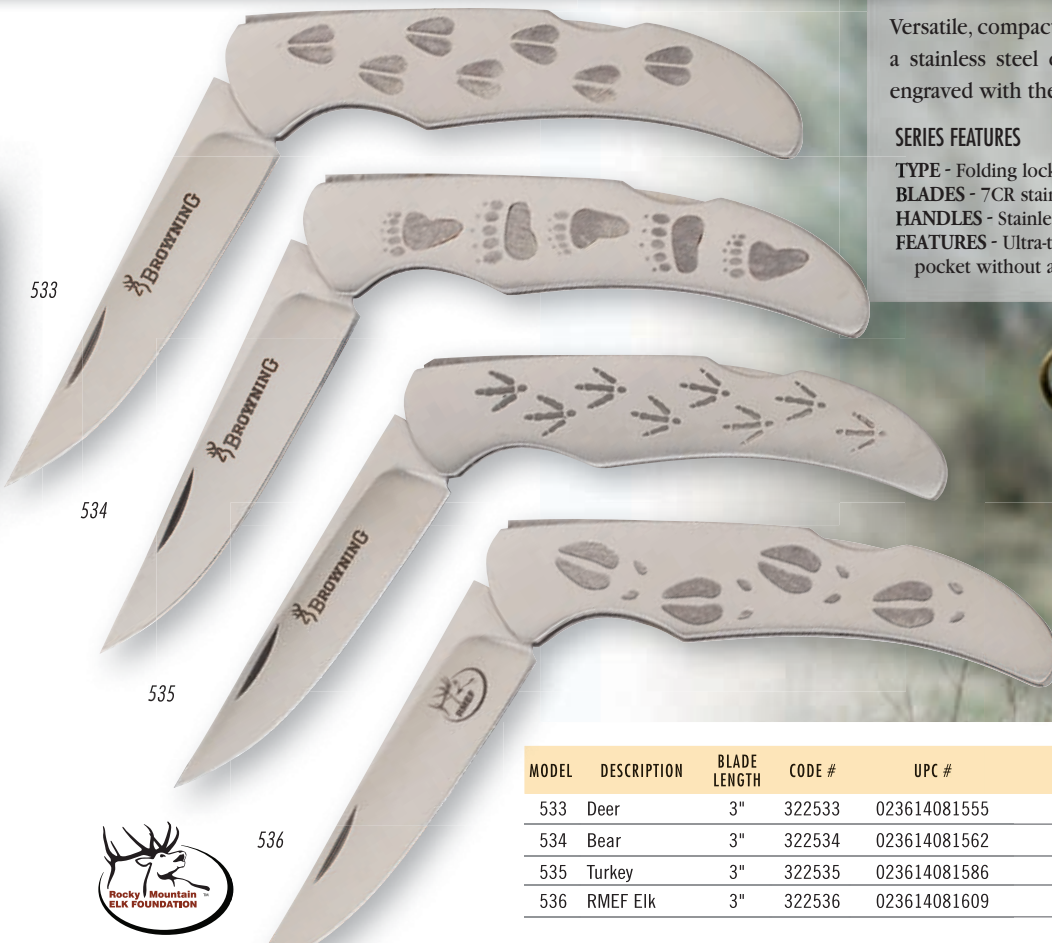

Versatile, compact and rugged, Backtrack Folders feature a stainless steel clip point blade and handles that are engraved with the tracks of popular game animals.

**SERIES FEATURES**

- TYPE - Folding lockback
- BLADES - 7CR stainless steel
- HANDLES - Stainless steel with game track engraving
- FEATURES - Ultra-thin construction slides easily into pocket without adding excess bulk

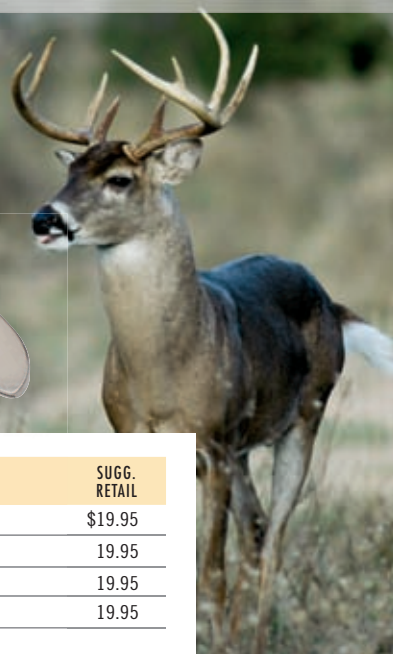

MODEL	DESCRIPTION	BLADE LENGTH	CODE #	UPC #	SUGG. RETAIL
533	Deer	3"	322533	023614081555	\$19.95
534	Bear	3"	322534	023614081562	19.95
535	Turkey	3"	322535	023614081586	19.95
536	RMEF Elk	3"	322536	023614081609	19.95





**PRISM II KNIVES**

**NEW**



Convenient to take along nearly everywhere, lightweight Prism II folders open easily with one hand to reveal a razor-sharp modified clip point blade. Colorful anodized handles with laser-cut Buckmarks make these knives look as sharp as their blades.



**SERIES FEATURES**

- TYPE** - Folding frame lock
- BLADES** - 440-A stainless steel
- HANDLES** - Anodized machined aluminum · Stainless steel bolsters
- FEATURES** - Pocket clip · Thumbstud

MODEL	DESCRIPTION	BLADE LENGTH	CODE #	UPC #	SUGG. RETAIL
5622	<b>NEW</b> Prism II, Pink	2½"	3225622	023614085287	\$14.95
5632	<b>NEW</b> Prism II, Orange	2½"	3225632	023614085294	14.95
5642	<b>NEW</b> Prism II, Blue	2½"	3225642	023614085300	14.95
5652	<b>NEW</b> Prism II, Green	2½"	3225652	023614085317	14.95
5662	<b>NEW</b> Prism II, Black	2½"	3225662	023614085324	14.95
5672	<b>NEW</b> Prism II, MOINF	2½"	3225672	023614085331	14.95

**MOUNTAIN Ti KNIVES**



**SERIES FEATURES**

- TYPE** - Folding frame lock
- BLADES** - 440-A stainless steel · Titanium coated
- HANDLES** - Two-tone gray machined 420J1 stainless · Titanium coated
- FEATURES** - Pocket clip · Ambidextrous thumbstud

Lightweight and rugged, Mountain Ti knives feature a razor-sharp, highly versatile drop-point style folding blade design. The contrasting finish on the stainless steel handles is striking, while the titanium-coating on the blade adds to corrosion resistance. A pocket clip keeps the knife at the ready and easy one-hand opening puts the knife quickly into action. The frame lock offers excellent security.

MODEL	DESCRIPTION	BLADE LENGTH	CODE #	UPC #	SUGG. RETAIL
560	Mountain Ti, Medium	3"	322560	023614040835	\$19.95
561	Mountain Ti, Small	2¼"	322561	023614040842	14.95



**BACKCOUNTRY SERIES KNIVES**

A solid knife can take care of the chores of several tools. Whether it's chopping limbs for a fire, clearing a shooting lane, cleaning a trout or dressing a grouse, Browning Backcountry Series knives are a handy addition to your gear with full-length tapered tangs for maximum balance. Sturdy canoe handles offer a secure grip in all conditions. Top grain leather sheath included.



**SERIES FEATURES**

**TYPE** - Fixed blade

**BLADE** - Sandvik® 12C27 stainless steel

**HANDLE** - Brown resin-laminated canvas

**FEATURES** - Top-grain leather sheath · Sharpening stone included with Camp Knife

MODEL	DESCRIPTION	BLADE	CODE #	UPC #	SUGG. RETAIL
976	<b>NEW</b> Backcountry Hunting Knife	4 1/4"	322976	023614085102	\$89.95
975	Backcountry Camp Knife	6 1/4"	322975	023614081647	109.95

**CROWELL/BARKER COMPETITION KNIFE**



James Crowell

This unique knife is a joint design effort between James Crowell and Reggie Barker, the only two men to have won an American Bladesmith Society (ABS) World Cutting Championship. Jim Crowell is well known in the knife industry and the first to win the ABS World Championship. Reggie Barker is known as "The Sharpest Man in Texas," and won the ABS World Champion title for the third time at the 2007 BLADE Show. He's also won the 2004 and 2005 ABS World Championship Cutting Competition. The Browning Crowell/Barker Competition Knife includes a top-grain leather sheath and a Certificate of Authenticity, signed by both Jim Crowell and Reggie Barker.



Reggie Barker

*This knife is approved for select International Cutting Competition Trail (ICCT) events. To learn more about this exciting new action sport, visit [cuttingcompetition.com](http://cuttingcompetition.com).*



**TYPE** - Fixed blade competition

**BLADE** - Heavy drop point, made from high-carbon steel with a .142 satin finish · Laser-etched on one side

**HANDLE** - Resin-laminated canvas with three rivets and wrist lanyard

**FEATURES** - Custom-made top-grain leather sheath

MODEL	DESCRIPTION	BLADE	CODE #	UPC #	SUGG. RETAIL
580	Crowell/Barker Comp.	10"	322580	023614205098	\$149.95

*Master Bladesmiths are trained professionals. Caution should be heeded when using sharp objects. Browning assumes no responsibility for misuse of its products.*



**GUNSTOCK SERIES KNIVES**

**NEW**



**SERIES FEATURES**

**TYPE** - Folding pocket knives  
**BLADES** - 440 stainless steel  
**HANDLES** - Jigged bone  
**FEATURES** - Polished bolsters

Sized to fit in your pocket, new Gunstock Series knives are reminiscent of those classics owned by your dad or grandpa. Jigged bone scales are checkered to resemble your favorite Browning firearm. Highly polished bolsters and edge-holding 440 stainless steel blades give Gunstock knives the edge.

MODEL	DESCRIPTION	BLADE LENGTH	CODE #	UPC #	SUGG. RETAIL
875	<b>NEW</b> Gunstock, One Blade	2¾"	322875	023614085201	\$19.95
876	<b>NEW</b> Gunstock, Two Blade	2¾"	322876	023614085218	19.95
877	<b>NEW</b> Gunstock, Three Blade	2½"	322877	023614085225	19.95

**FAST TASK SERIES KNIVES**

**NEW**

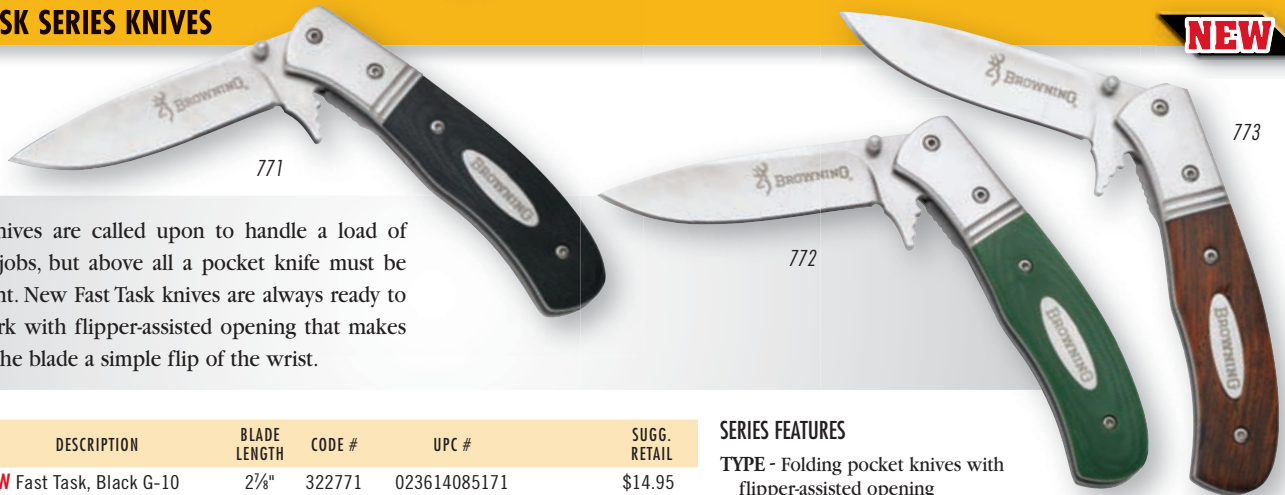

Pocket knives are called upon to handle a load of different jobs, but above all a pocket knife must be convenient. New Fast Task knives are always ready to go to work with flipper-assisted opening that makes opening the blade a simple flip of the wrist.

**SERIES FEATURES**

**TYPE** - Folding pocket knives with flipper-assisted opening  
**BLADES** - 440 stainless steel  
**HANDLES** - G-10 or rosewood  
**FEATURES** - Stainless bolsters

MODEL	DESCRIPTION	BLADE LENGTH	CODE #	UPC #	SUGG. RETAIL
771	<b>NEW</b> Fast Task, Black G-10	2½"	322771	023614085171	\$14.95
772	<b>NEW</b> Fast Task, Green G-10	2½"	322772	023614085188	14.95
773	<b>NEW</b> Fast Task, Rosewood	2½"	322773	023614085195	14.95

**PRESENTATION LOCKBACK KNIVES**

A Browning Presentation Lockback knife makes the perfect gift. A variety of handle materials ensures there is a knife that suits every taste. All feature a high-quality stainless steel blade, excellent fit and finish and satin-finished bolsters with a polished stripe. Presentation Lockbacks are ideal for having names, initials or company logos engraved on the bolsters or blade.



**SERIES FEATURES**

**TYPE** - Folding lockback  
**BLADES** - AUS-8A stainless steel  
**HANDLES** - Cocobolo, quince, bone or stainless steel  
**FEATURES** - Presentation case with gold Browning logo

MODEL	DESCRIPTION	BLADE LENGTH	CODE #	UPC #	SUGG. RETAIL
305	Cocobolo, Lockback	2¾"	322305	023614567172	\$39.95
306	Quince, Lockback	2¾"	322306	023614567189	49.95
3071	<b>NEW</b> Bone, Lockback	2¾"	3223071	023614085454	59.95
316	Stainless, Lockback	2¾"	322316	023614041856	39.95



**OUTDOORSMAN STEAK KNIVES AND KITCHEN CUTLERY SET**

Nothing is used more in the kitchen than a good set of sharp knives. Kitchen knives must be durable, have a variety of blade shapes for specific tasks and remain sharp, especially when used for processing wild game. The 14-piece Outdoorsman Kitchen Cutlery set has everything necessary for the home or cabin, including a hollow-ground boning knife that holds a razor edge, game shears and a sharpening steel. The set also includes standard kitchen cutlery and a uniquely designed carving fork with a pigtail twist so it won't bend when lifting a 10-pound roast from the pan. The set has a standard chef's knife with an innovative scalloped blade to reduce friction for carving meat, and six elegant steak knives for table use. Another favorite will be the bread knife, with large serrations, to make slicing warm homemade bread easy. The knives are made from quality German steel to ensure the Outdoorsman Set will last. A metal Browning Buckmark is set in the durable injection molded handles.

**SERIES FEATURES**

- TYPE - Steak knives/Kitchen cutlery
- BLADES - German X50CrMoV15 steel
- HANDLES - Durable injection molded handles with inlaid metal Buckmark
- FEATURES - 480: Black wood block  
· 480C: Bamboo block



480C



480



481



MODEL	DESCRIPTION	BLADE LENGTH	CODE #	UPC #	SUGG. RETAIL
480C	<b>NEW</b> Kitchen Cutlery Set, Bamboo Block	N/A	322480C	023614078753	\$324.95
480	Kitchen Cutlery Set, Black	N/A	322480	023614077381	324.95
481	Six Steak Knife Set, Black	4¼"	322481	023614077831	139.95

**CHINOOK KNIVES, FULL LINE DEALER**



590

591

Versatile, rugged and razor sharp, Chinook knives are designed to be clipped to a pocket or belt so they are always at the ready. The handle shape comfortably fits in your hand and the contrasting finish on the handle and bolster offers lasting good looks. The liner lock adds excellent security and is easy to operate with your thumb.

**SERIES FEATURES**

- TYPE - Folding liner lock
- BLADES - 440-A stainless steel, 590 is half-serrated
- HANDLES - 590: Aluminum handle with titanium electroplated steel bolster · 591: Titanium electroplated steel handle with aluminum bolster
- FEATURES - Pocket clip · Thumbstud · Available only from Browning Full Line and Medallion Dealers



MODEL	DESCRIPTION	BLADE LENGTH	CODE #	UPC #	SUGG. RETAIL
590	Chinook, Charcoal	2¾"	322590	023614078364	\$39.95
591	Chinook, Titanium	2¾"	322591	023614078371	39.95



CAMPMATE KNIFE



SERIES FEATURES

- TYPE - Folding with liner lock knife
- BLADES - AUS-8A stainless steel
- HANDLES - Injection-molded composite
- FEATURES - Nylon sheath included

MODEL	DESCRIPTION	CODE #	UPC #	SUGG. RETAIL
970	Campmate Knife, Black	322970	023614080985	\$19.95
971	Campmate Knife, MONBU	322971	023614081043	24.95

CAMP SAWS



There are many folding saws on the market, but none can match a Browning. The canoe-shaped rubber handle has finger grooves and a large tail radius to ensure a rock solid grip and fatigue-free comfort in your hand. The high-carbon stainless steel push/pull blade maximizes cutting efficiency on wood and when dressing game. The unique sheath can be worn in both horizontal and vertical positions. Compact, lightweight and durable, this saw is the ultimate at a price that can't be beat. Camp Saw Combos include a folding knife with a secure liner lock and thumbstud.

MODEL	DESCRIPTION	CODE #	UPC #	SUGG. RETAIL
922	Camp Saw (5¾" Blade), Black	322922	023614080923	\$19.95
923	Camp Saw (5¾" Blade) and Knife (3½" Blade), Black	322923	023614080947	29.95
924	Camp Saw (5¾" Blade), MONBU	322924	023614081746	29.95
925	Camp Saw (5¾" Blade) and Knife (3½" Blade), MONBU	322925	023614081753	39.95

SERIES FEATURES

- TYPE - Folding saw and folding saw/knife combo
- BLADES - 4116 stainless steel saw · 7CR stainless steel knife
- HANDLES - Saw: Injection molded composite with rubber inlay · Knife: Anodized aluminum
- FEATURES - Nylon sheath included with saw · Knife includes pocket clip



# LIGHTS

## HOW TO CHOOSE A FLASHLIGHT

Browning is a leading manufacturer of portable battery-powered lighting. For 2011, we have expanded our line to more than 50 styles. So, how do you choose the light that best meets your needs?

## SIZE, WEIGHT AND POWER

Smaller and lighter are better. New high-output LEDs from manufacturers like Luxeon® and Cree® are incredibly powerful and efficient, and don't require the size and weight of the old C and D battery lights to achieve the same light output. Our Alpha and Alpha Max flashlights, with a single AA battery, are brighter than the flashlights of the past and are no bigger than a shotgun shell.

## LED VS. XENON BULBS

LEDs are now preferred over Xenon and other types of filament bulbs for most uses. LEDs use batteries more efficiently, illuminate at equal or greater distance, emit a clean white versus a dull yellow beam and will not burn out under normal use. LEDs are also nearly unbreakable.

## HAND-HELD OR HANDS-FREE

Headlamps and cap lights allow the use of both hands for other tasks like dressing a deer, fixing the truck or finding a path through the woods. With modern technology many headlamps are as powerful as a larger hand-held flashlight. Several Browning headlamps, such as MicroBlast and Phantom can be worn either as a headlamp or clipped to the brim of a hat.

## BATTERIES

Lithium batteries are used in many of our highest-performing lights, such as the Catalyst, Hunt Master and Nitro. Lithium batteries pack about twice the power of alkaline batteries for their weight, and operate at very cold temperatures. Convenient AA and AAA alkaline batteries are also used extensively because they cost less than lithium and are more readily available. The latest integrated circuit designs in our Hi Power, Pro Hunter, Zeta and Alpha Max flashlights boost the performance of alkaline batteries to approach the performance of lithium batteries.

## SWITCH SETTINGS

Single-action switches (on/off) are preferred for self-defense and tactical applications. Multiple switch settings (high, low and in-between) preserve battery life and allow selecting between colors and flashing options. Lock-out switches on many Browning lights keep the light from accidentally turning on.

## RED, GREEN AND BLUE

Colored LEDs help preserve night vision, are great for map reading and are less obvious than white light to many types of game animals when walking to a tree stand in the dark.



## LIGHTS INDEX

<b>ACCESSORIES</b>	<b>186</b>
<b>CAP LIGHTS</b>	
Night Seeker	184
Night Seeker Pro	184
<b>FLASHLIGHTS</b>	
Alpha and Alpha Max	177
Catalyst	178
Duck Call Lanyard	180
Hi Power	176
Hunt Master	178
MicroBlast	181
Pro Hunter	179
Spitfire	180
Tactical Hunter	175, 177
Zeta	177
<b>HEADLAMPS</b>	
MicroBlast	183
Nitro	177
Phantom	183
Pro Hunter	182
Renegade	183
<b>KEYCHAIN LIGHTS</b>	
Choke Tube	185
Echo	185
<b>KNIFE/LIGHT COMBOS</b>	181
<b>LANTERNS</b>	186
<b>PEN LIGHTS</b>	181
<b>POCKET LIGHTS</b>	
Night Seeker	185
<b>REPLACEMENT BULBS AND BATTERIES</b>	186

## BROWNING ADOPTS ANSI FL-1 PERFORMANCE STANDARDS

Beginning in 2010, many top flashlight manufacturers agreed to use the same standards (ANSI-FL1) for measuring performance, so you can make an apples-to-apples comparison between models. We are proud to endorse and participate in these standards for portable lighting.\*



Lumens = Brightness. A traditional 2D flashlight is approximately 15 - 20 lumens.



Battery Life (Run Time) is defined as the time elapsed when the batteries are new to when the light reaches 10% of the original brightness.



Maximum Distance is measured as the distance in meters from the light to where it decreases in brightness to 0.25 lux — about the brightness of the full moon on a clear night.

\* For Browning lights with multiple settings, the Lumens, Battery Life and Distance are stated in the specifications at the highest setting (100% power), unless indicated otherwise.



TACTICAL HUNTER CONTROL POINT FLASHLIGHTS

**NEW**

The Browning Control Point is as powerful as any two battery light we've ever offered. This wonder combines the latest Luxeon® LED with a pair of 3V Lithium batteries and advanced electronics for a flashlight that outperforms all other flashlights in its class. In addition to tremendous light output and superior battery life, Control Point flashlights now offer five brightness levels to provide just the light you need (high [100%],

medium-high [80%], medium [60%], medium-low [35%], low [10%]) and three flashing modes (fast strobe, normal strobe and S.O.S.). A rotating selector switch on the tailcap controls the electronics and a tactical, push button on/off switch on the end of the light makes it easy to turn the light on in a momentary function. Try a Control Point and it is clear to see why this light outshines all the rest in the portable lighting market.



3711240

**L = LIGHT**  
5 Settings, High to Low

**O = OFF**

**F = FLASHING**  
S.O.S, Slow or Fast Strobe

**M = MOMENTARY**

Control Point Rotating Selector Switch

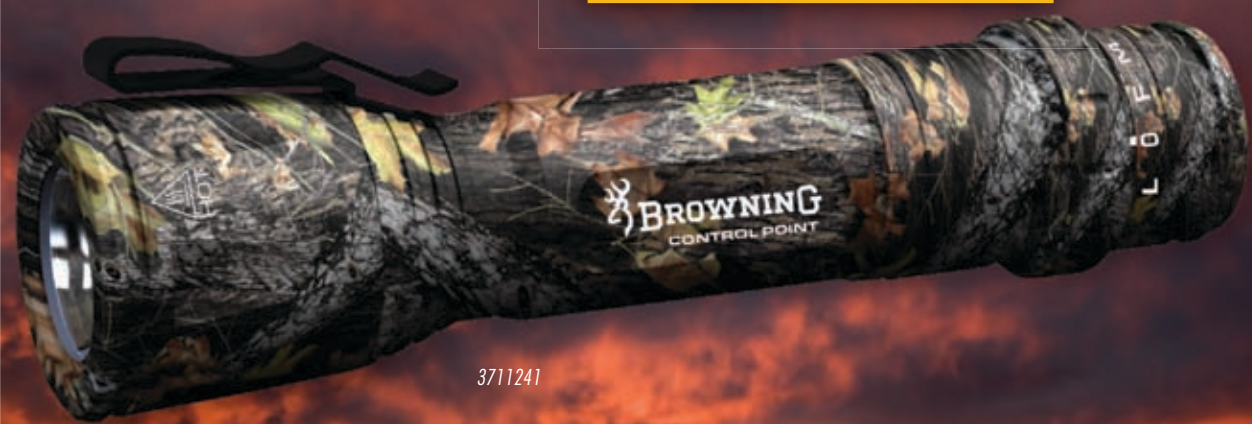

3711241

**NOW WITH 4 MODES AND 10 SETTINGS!**

- All-aluminum construction and O-ring sealed for water resistance
- Advanced digital circuitry delivers maximum power
- Rugged Tactical Hunter design with lock-out switch and Deep Pocket™ carry clip
- Length: 5.6"
- Brightness: 175 lumens
- Effective distance: 150 meters

**CONTROL POINT**

DESCRIPTION	LED	CODE #	UPC #	BATTERIES	BATTERY LIFE	LUMENS	SUGG. RETAIL
<b>NEW</b> Tactical Hunter Control Point, Black	Luxeon Rebel	3711240	023614080541	(2) CR123A Lithium	High: 2.5 hours	175	\$74.99
<b>NEW</b> Tactical Hunter Control Point, MONBU with Dura-Touch Armor Coating	Luxeon Rebel	3711241	023614080565	(2) CR123A Lithium	High: 2.5 hours	175	79.99



HI POWER FLASHLIGHTS

With great looks and the potential to squeeze every last drop of energy from a pair of common, easy-to-find AA alkaline batteries, our award winning Hi Power flashlights blend innovative technology with a striking appearance. The latest advancements in circuitry allow the AA-powered LED Hi Power to rival most lithium-powered lights for both lumen output and battery life. Protecting this leading-edge technology is a precision-

machined aluminum housing available with tough resin inlays or the same American walnut used for our firearms set into the grip for a great new look. The side located, push-button switch is simple to use and includes a lock-out to keep the switch from accidentally turning on. One thing is for certain, when it comes to looks, convenience, battery life and sheer lumen output, the Hi Power flashlight is sure to be the first light you reach for.

- All-aluminum construction with walnut or black resin handle inlays
- Latest generation Cree® XP-E LED is rated for 50,000 hours use
- High-low electronic switch with lock-out
- O-ring sealed for water resistance
- Includes lanyard and two AA batteries
- Length: 5.25"
- Brightness: 145 lumens
- Effective distance: 150 meters

3715303



3715304



3715302



3715301



3715305



HI POWER

DESCRIPTION	LED	CODE #	UPC #	BATTERIES	BATTERY LIFE	LUMENS	SUGG. RETAIL
Hi Power, Gun Finish Matte Silver with American Walnut	Cree XP-E	3715303	023614080497	(2) AA Alkaline	1.5 hours	145	\$74.99
Hi Power, Matte Finish Desert Metallic with Black Resin	Cree XP-E	3715304	023614080503	(2) AA Alkaline	1.5 hours	145	74.99
Hi Power, MONBU with Black Resin and Dura-Touch Armor Coating	Cree XP-E	3715302	023614080480	(2) AA Alkaline	1.5 hours	145	74.99
Hi Power, Gun Finish Matte Black with American Walnut	Cree XP-E	3715301	023614080473	(2) AA Alkaline	1.5 hours	145	74.99
Hi Power, Gun Finish Matte Black with American Walnut and RMEF logo	Cree XP-E	3715305	023614080527	(2) AA Alkaline	1.5 hours	145	74.99



**NITRO HEADLAMP**

Our brightest, most-powerful headlamp · Luxeon® Rebel LED shines 100 meters on high setting; plus two red and two green LEDs · Lock-out switch with settings for high and low · Unbreakable LEDs are rated for 100,000 hours use · CR123A battery operates to -40° F · Includes headstrap, or use with hat clip · Glass-fiber reinforced polycarbonate housing with aluminum lens ring · Silent Hinge™ for stealth · Brightness: 110 lumens · Effective distance: 100 meters



*Martin Buser and his Happy Trails Kennels sled dog teams have won the grueling 1,161 mile Iditarod Trail Sled Dog Race an impressive four times. Their 1997 victory still holds the course record for the fastest finish time. Martin has relied on the Browning Nitro headlamp since 2008 to steer his team through the darkest Alaskan nights. "I am always searching for durable, unique products to give me an edge. The long-reaching, focused beam of the Nitro stretches past 80 feet of the sled team and makes finding trail markers easier. The lithium batteries are great because they last longer and are less affected by the cold than alkaline batteries."*

— MARTIN BUSER



DESCRIPTION	LED	CODE #/UPC #	BATTERIES	BATTERY LIFE	LUMENS	SUGG. RETAIL
Nitro Max Output Headlamp, MONBU	110 Lumen Luxeon Rebel + (2) Red, (2) Blue	3718620 023614041825	(1) CR123A Lithium	High: 3 hours; Low: 8 hours Red, Blue LEDs: 15 hours	110	\$49.99

**ALPHA, ALPHA MAX AND ZETA FLASHLIGHTS**

Powerful Browning flashlights offer more illumination with innovative new LED bulbs that provide more lumens and make excellent use of battery life. Compact and powerful, these flashlights use standard AA alkaline batteries and fit easily in a pocket. A lock-out tailcap switch features a momentary function, and single-action on/off for simplicity and

maximum control. Rugged aircraft aluminum construction protects the high-tech circuitry and the LEDs. The Deep Pocket™ carry clip holds the light securely in your pocket where it's easy to find and is removable if it is not needed. Check out the latest innovations in handheld lighting technology, available from Browning.



TACTICAL HUNTER

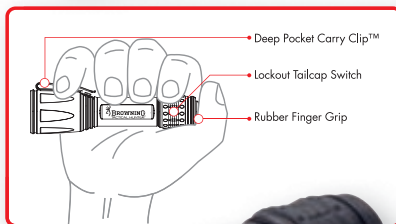

- Alpha delivers 90 lumens; Alpha Max delivers 100 lumens, shines over 100 meters, and is no bigger than a shotgun shell
- Digital circuitry delivers maximum power using only one battery
- Rugged Tactical Hunter design with lock-out switch and Deep Pocket™ carry clip
- Camo models feature Dura-Touch® Armor Coating
- Length - Alpha: 3.75" · Alpha Max: 3.9" · Zeta: 5.9"
- Brightness - Alpha: 90 lumens · Alpha Max: 100 lumens · Zeta: 120 lumens
- Effective distance - Alpha: 80 meters · Alpha Max: 100 meters · Zeta: 120 meters



DESCRIPTION	LED	CODE #	UPC #	BATTERIES	BATTERY LIFE	LUMENS	SUGG. RETAIL
<b>NEW</b> Tactical Hunter Alpha, Black	Luxeon Rebel	3711231	023614078258	(1) AA Alkaline	1.5 hours	90	\$39.99
Tactical Hunter Alpha Max, Black	Cree XR-E	3711239	023614080657	(1) AA Alkaline	1.5 hours	100	49.99
Tactical Hunter Alpha Max, MONBU	Cree XR-E	3711232	023614078265	(1) AA Alkaline	1.5 hours	100	54.99
Tactical Hunter Zeta, MONBU	Cree XR-E	3711242	023614080589	(2) AA Alkaline	3.0 hours	120	59.99



CATALYST FLASHLIGHTS



3711243



3711230

- Our brightest two battery flashlights
- Rugged, tactical-style thumb switch with lock-out switch
- MONBU models have a single-action on/off switch, while Catalyst Olive Drab and Digital Camo models have an electronic high-low switch and a rapid strobe function
- Features the brightest available LEDs for maximum distance and lumens
- Deep Pocket™ carry clip keeps the light secure in your pocket
- Max View™ focused square beam for instant area illumination
- Three colored filters (red, blue, green) for maximum stealth and night vision
- All-aluminum construction with unbreakable lens
- Camo models feature Dura-Touch® Armor Coating
- Length: 5"
- Brightness: 175 lumens
- Effective distance: 150 meters



3711235

TACTICAL HUNTER

HUNT MASTER

HUNT MASTER VXT

The new Hunt Master VXT features a powerful new green LED for maximum stealth and enhanced night vision. The new Cree® XP-C green LED is a bright 70 lumens — about 15 times more powerful than a standard 4-5 lumen green LED — to send the beam past 60 meters. Two Cree XP-E LEDs emit 225 lumens of clean white light. The VXT also features an adjustable spot-to-flood lens design and a memory feature that returns the light to the last setting you used.

- Powerful 70 lumen green LED
- Focusable lens for flawless spot beam
- Smaller than a 2D flashlight
- CR123A batteries operate to -40° F
- All-aluminum construction with unbreakable lens
- High-power LEDs are rated for 100,000 hours use
- Length: 6.6"
- Brightness: 225 lumens
- Effective distance: 100 meters



NEW

3711211

HUNT MASTER

With three Luxeon® Rebel LEDs and an awesome 300 lumen output, the Hunt Master is the brightest flashlight in the Browning line-up. The Hunt Master utilizes advanced circuitry to manage power from three CR123A batteries to leave larger, heavier flashlights in the dust. The Hunt Master also features an adjustable spot-to-flood lens design to focus light to your needs. Precision aluminum housing.

- Focusable lens for flawless spot beam
- Smaller than a 2D flashlight
- CR123A batteries operate to -40° F
- All-aluminum construction with unbreakable lens
- High-power LEDs are rated for 100,000 hours use
- Length: 6.6"
- Brightness: 300 lumens
- Effective distance: 150 meters



3711236

DESCRIPTION	LED	CODE #	UPC #	BATTERIES	BATTERY LIFE	LUMENS	DISTANCE	SUGG. RETAIL
Catalyst, Digital Camo	Luxeon Rebel	3711243	023614080664	(2) CR123A Lithium	2.5 hours	175	150 meters	\$69.99
Catalyst, MONBU	Luxeon Rebel	3711230	023614172758	(2) CR123A Lithium	High: 2.5 hours Low: 12 hours	175	150 meters	69.99
Catalyst, Olive Drab	Luxeon Rebel	3711235	023614078296	(2) CR123A Lithium	High: 2.5 hours Low: 12 hours	175	150 meters	64.99
<b>NEW</b> Hunt Master VXT, Black	(1) Cree XP-C Green (2) Cree XP-E White	3711211	023614085348	(3) CR123A Lithium	High: 5 hours Low: 12 hours Green: 12 hours	High: 225 Low: 85 Green: 70	100 meters 55 meters 70 meters	99.99
Hunt Master, Olive Drab	(3) Luxeon Rebel	3711236	023614078302	(3) CR123A Lithium	High: 3.5 hours Low: 8 hours	300	150 meters	99.99



PRO HUNTER LED FLASHLIGHTS

PRO HUNTER FLASHLIGHTS

Pro Hunter flashlights feature long-running, powerful LEDs, rugged lightweight polymer bodies with rugged aluminum lens rings, and the very latest in circuit and switch design. The new Classic Pro and Twin Beam+ are among the most powerful lights in their class. Both sport a screaming Cree® XP-C LED for maximum lumens and distance. The Twin-Beam+ includes a new “Mean Green” LED rated at 70 lumens, and a new Soft-Sunshine LED for blood tracking. Affordable and easy to find AAA batteries are included with all models. A tactical-style lock-out end cap disables the switch to assure the light is not turned on accidentally. A carrying lanyard and ribbed body provide maximum grip in wet or cold weather. ANSI rated for water resistance. LEDs are rated for 50,000 to 100,000 hours and will not burn out under normal use.

RGB FLASHLIGHT

The Pro Hunter RGB features a pair of high-intensity LEDs for long distance, one wide view LED for maximum peripheral vision and one red-green-blue LED that enhances night vision and is stealthier around game animals. The RGB is a bright 40 lumens on the high setting. Black with matte aluminum lens ring. Three AAA alkaline batteries (included). All this, and the RGB is easy on your wallet too.

PRO HUNTER LED

The original Pro Hunter flashlight features unbreakable, long-running LEDs. The center 0.5W LED pushes 25 lumens out to 50 meters and two red and two green LEDs provide improved night vision and safety, and are stealthy around game animals. Dura-Touch® Armor Coating enhances grip in all conditions.

CLASSIC PRO

Pure power is what these lights are all about. The Classic Pro is rated at 100 lumens, out to 100 meters and beyond. A tactical end-cap switch with high, low and flashing settings is simple to use and includes a lock-out that disables the switch to protect the batteries. The Classic Pro is certain to become a favorite for performance, good looks and cost-efficiency.

TWIN BEAM+

With 100 lumens in the main beam, the new Twin Beam+ is the ultimate hunting flashlight. The main beam uses a Cree® XP-C LED to throw 100 lumens of light out to 100 meters. A new green Cree® XP-C LED emits 70 lumens — easily 15 times more powerful than other green LEDs that give off 4-5 lumens — for the maximum in stealthy brightness without disturbing the animals nearby. A new Soft-Sunshine LED limits glare for better up-close map reading and tracking. The light flashes in any setting (including green) by holding down the switch for 2 seconds. Memory feature returns to the most recent setting when you turn the light back on. Three AAA batteries are included.



- Ultra-light, ultra-tough polymer construction with rugged aluminum lens ring
- Textured non-slip body for secure grip in wet weather
- O-ring sealed for water-resistance
- Length - 5.1"

PRO HUNTER

DESCRIPTION	LED	CODE #/UPC #	BATTERIES	BATTERY LIFE	LUMENS	DISTANCE	SUGG. RETAIL
Pro Hunter RGB, Black	(2) Nichia 5mm wide (1) Nichia 5mm Wide View (1) RGB LED	3713314 023614080688	(3) AAA Alkaline	High+Wide: 25 hours High: 30 hours RGB: 40 hours	High+Wide: 40 High: 30 RGB: 3-4	High+Wide: 25 meters High: 25 meters RGB: 8-12 meters	\$19.99
Pro Hunter LED, MOBU	Nichia 0.5 Watt + (2) 5mm Green, (2) Red	3713312 023614074335	(3) AAA Alkaline	0.5 watt: 6 hours Green/Red: 30 hours	0.5 watt: 25 Green/Red: 6-8	0.5 watt: 50 meters Green/Red: 15 meters	29.99
<b>NEW</b> Pro Hunter Classic Pro, Mossy Oak Pink	Cree XP-C	3713323 023614085362	(3) AAA Alkaline	High: 6 hours Low: 24 hours	High: 100 Low: 35	High: 100 meters Low: 50 meters	34.99
<b>NEW</b> Pro Hunter Classic Pro, Mossy Oak Break-Up Infinity	Cree XP-C	3713322 023614085355	(3) AAA Alkaline	High: 6 hours Low: 24 hours	High: 100 Low: 35	High: 100 meters Low: 50 meters	34.99
<b>NEW</b> Pro Hunter Twin Beam, Charcoal	(1) Cree XP-C White (1) Cree XP-C Green (1) Soft-Sunlight 5mm LED	3713324 023614085379	(3) AAA Alkaline	White: 6 hours Green: 6 hours SS LED: 32 hours	High: 100 Low: 70 SS LED: 10	High: 100 meters Low: 70 meters SS LED: 15 meters	39.99



**SPITFIRE FLASHLIGHT**

- Powerful Cree® XP-C LED for bright, reliable illumination
- LEDs are rated for 50,000 hours and will never need to be replaced
- Ultralight, ultratough machined aluminum construction
- Textured non-slip body for secure grip in wet weather
- O-ring sealed for water resistance
- Length: 6"
- Brightness: 90 lumens
- Effective distance: 125 meters



3714120

Now 12% brighter, the value-packed, super bright LED Spitfire flashlight operates on two AA batteries. This tough, reliable flashlight is water-resistant and easily passes demanding "drop-tests" onto concrete from a height of 1 meter and higher. The highly-focused LED beam is tuned for long distances and shines out to 125 meters. A tactical-style tailcap switch is easy to operate and features a momentary on/off or lock-on.

DESCRIPTION	LED	CODE #	UPC #	BATTERIES	BATTERY LIFE	LUMENS	SUGG. RETAIL
<b>NEW</b> Spitfire	Cree XP-C	3714120	023614080671	(2) AA Alkaline	1.75 hours	90	\$29.99

**DUCK CALL LANYARD LIGHT**



3712122

- Designed to clip to a call lanyard
- Nichia® 5mm LED is brighter than many larger flashlights
- Digital circuitry delivers maximum power using a single AAA battery
- Twist-switch prevents accidental activation
- Rugged aircraft aluminum housing with unbreakable LED and lens
- Extra-strong metal lanyard with spring clip
- Brightness: 20 lumens
- Effective distance: 35 meters



DESCRIPTION	LED	CODE #	UPC #	BATTERIES	BATTERY LIFE	LUMENS	DISTANCE	SUGG. RETAIL
Duck Call Lanyard Light	Nichia 5mm White LED	3712122	023614079156	(1) AAA Alkaline	1.5 hours	20	35 meters	\$19.99

**NIGHT SEEKER POCKET LIGHT**

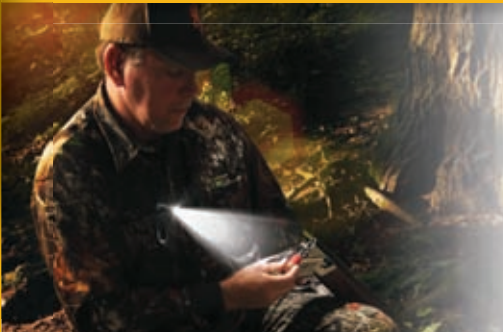

3715105

Enjoy hands-free lighting with the new Night Seeker pocket light. A flexible clip attaches the light to a pocket, sleeve or strap. The head pivots 360° and tilts up and down to aim the beam right where you need it. Also great as a free-standing spotlight. Two high-intensity Nichia® 5mm LEDs offer maximum brightness and distance. Two 2032 batteries included.

- Clips to a pocket or strap
- Two Nichia® 5mm LEDs
- Digital circuitry delivers maximum power
- Push-button switch
- Unbreakable LED and lens
- Brightness: 15 lumens
- Effective distance: 20 meters

DESCRIPTION	LED	CODE #	UPC #	BATTERIES	BATTERY LIFE	LUMENS	DISTANCE	SUGG. RETAIL
<b>NEW</b> Night Seeker Pocket Light	(2) Nichia 5mm White LEDs	3715105	023614085386	(2) CR2032	6.5 hours	15	20 meters	\$11.99



**KNIFE AND LIGHT COMBOS**

**MICROBLAST LIGHT**

- Use as flashlight, cap light or keychain light
- 5mm LED is brighter than many 2 AA flashlights
- Digital circuitry delivers maximum power using only one battery
- All aluminum construction with unbreakable lens
- O-ring sealed for water resistance
- Length: 2.9"
- Brightness: 15 lumens
- Effective distance: 20 meters

3712118



3712219



**MICROBLAST**

**MICROBLAST KNIFE**

- Folding knife with durable frame lock
- 2" stainless steel blade holds a sharp edge

DESCRIPTION	LED	CODE #	UPC #	BATTERIES	BATTERY LIFE	LUMENS	SUGG. RETAIL
MicroBlast Knife/Light Combo, Pink	5mm White	3712118	023614074465	(1) AAA Alkaline	Up to 7 hours	15	\$19.99
MicroBlast Knife/Light Combo, Charcoal	5mm White	3712219	023614078548	(1) AAA Alkaline	Up to 7 hours	15	19.99

**MICROBLAST FLASHLIGHT**



3712114

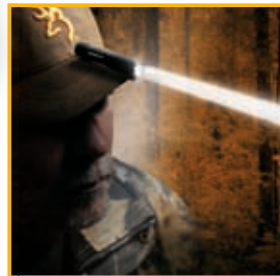

- Use as flashlight or cap light
- 0.5W LED is brighter than most AAA flashlights
- Digital circuitry delivers maximum power using only one battery
- All aluminum construction with unbreakable lens
- O-ring sealed for water resistance
- Length: 2.9"
- Brightness: 20 lumens
- Effective distance: 35 meters

DESCRIPTION	LED	CODE #	UPC #	BATTERIES	BATTERY LIFE	LUMENS	SUGG. RETAIL
MicroBlast, Black	0.5 Watt White Luxeon	3712114	023614172697	(1) AAA Alkaline	Up to 1.5 hours	20	\$19.99



**MICROBLAST PEN LIGHTS WITH BORE ADAPTERS**

- Superbright Nichia® 5mm LED shines at 15 lumens, 3X brighter than most other pen lights
- Two Bore Light Adapters included with AAA MicroBlast: red for map reading and white for firearm inspection and cleaning
- Covert Cover™ (AAAA models) slides up for spot beam, making the light unseen from the side
- Rugged all-aluminum construction with heavy-duty pocket clip

- Unbreakable LED lasts for 100,000 hours
- Two sizes: Ultra-slim with three AAAA batteries
- Standard with two AAA batteries
- Brightness: 15 lumens
- Effective distance: 20 meters



3712123



3712120

DESCRIPTION	LED	CODE #	UPC #	BATTERIES	BATTERY LIFE	LUMENS	DISTANCE	SUGG. RETAIL
MicroBlast Pen Light w/ Bore Adapter, Titanium	(1) 5mm Nichia White	3712120	023614078227	(3) AAAA Alkaline	30 hours	15	20 meters	\$14.99
MicroBlast Pen Light w/ 2 Bore Adapters, Charcoal	(1) 5mm Nichia White	3712123	023614080701	(2) AAA Alkaline	10 hours	15	20 meters	14.99



**PRO HUNTER HEADLAMPS**

Browning is proud to introduce a new line of powerful, rugged and sensibly-priced Pro Hunter headlamps for 2011. Each headlamp features the latest in LED technology and circuit design to give the brightest output and longest run times. The three common, inexpensive AAA Alkaline batteries used to power Pro Hunter headlamps are interchangeable with many other devices such as GPS and walkie-talkies. Durable lightweight polymer housings feature easy-to-use switch buttons. All headlamps tilt up and down to direct the light where needed, and come with adjustable, snug-fitting elastic headstraps.

**PRO HUNTER RGB HEADLAMP**

Based on the best-selling Pro Hunter RGB flashlight, the new RGB headlamp features the same extremely functional LED set with two high-intensity LEDs for long distance, a wide-view LED for maximum peripheral vision and one Red-Green-Blue LED. Colored LEDs enhance night vision and safety, and are more stealthy around game animals. Black front with charcoal accents.

**PRO HUNTER ESCAPE HEADLAMPS**

Escape headlamps feature three high-intensity LEDs for maximum brightness and long distances (up to 45 lumens and 40 meters) and one Soft-Sunlight LED for up-close lighting. The Soft-Sunlight LED is helpful when examining leaves, bark and grass at close distances for a blood trail, because it reduces glare and shadows. Also perfect for reading books and maps. Escape has three light settings, plus flashing. Maximum run time 32 hours. In Mossy Oak® camo patterns: Break-Up® Infinity™, Duck Blind® and Blaze®.

**PRO HUNTER MAXUS HEADLAMP WITH FOCUS-CONTROL**

Maxus is a versatile, technically-advanced, powerful headlamp worthy of the name. Zoom lever on front adjusts the focus of the main LED from spot to flood. Powerful Cree® LED sends 85 lumens to 80 meters or more. Three light levels (High, Medium, Low) and Flashing settings extend the maximum run time on Low to 24 hours. Memory switch returns to the most recent setting when you turn the light on. Plus two green and two red LEDs offer maximum stealth, safety and protect night vision. Black front with charcoal accents.



3713325



3713326



3713327



3713328



3713329

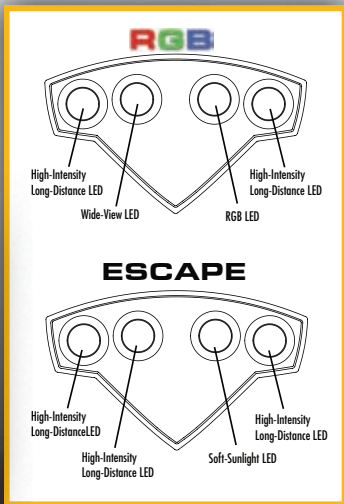

- All LED bulbs for reliability and maximum battery life
- 100,000 hour LEDs never need replacement
- Ultralight, ultratough polymer housing construction
- Comfortable elastic headband
- RGB includes a wide view LED for maximum peripheral vision and one red-green-blue LED that enhances night vision
- Escape features Soft-Sunlight LED that reduces glare to make reading and examining close objects easier on your eyes
- Maxus features Focus Control with adjustable spot-to-flood beam, three brightness levels and flashing

DESCRIPTION	LED	CODE #/UPC #	BATTERIES	BATTERY LIFE	LUMENS	DISTANCE	SUGG. RETAIL
<b>NEW</b> Pro Hunter RGB Headlamp, Black	(2) Nichia 5mm (1) Nichia 5mm Wide View (1) RGB LED	3713325 023614085393	(3) AAA Alkaline	High+Wide: 25 hours High: 30 hours RGB: 40 hours	High+Wide: 40 High: 30 RGB: 3-4	High+Wide: 25 meters High: 25 meters RGB: 8-12 meters	\$24.99
<b>NEW</b> Pro Hunter Escape Headlamp, MOINF	(3) Nichia 5mm (1) Soft-Sunlight 5mm LED	3713326 023614085409	(3) AAA Alkaline	High: 10 hours Medium: 18 hours SS LED: 32 hours	High: 45 Medium: 30 SS LED: 10	High: 40 meters Medium: 30 meters SS LED: 10 meters	29.99
<b>NEW</b> Pro Hunter Escape Headlamp, MO BLAZE	(3) Nichia 5mm (1) Soft-Sunlight 5mm LED	3713327 023614085416	(3) AAA Alkaline	High: 10 hours Medium: 18 hours SS LED: 32 hours	High: 45 Medium: 30 SS LED: 10	High: 40 meters Medium: 30 meters SS LED: 10 meters	29.99
<b>NEW</b> Pro Hunter Escape Headlamp, MODB	(3) Nichia 5mm (1) Soft-Sunlight 5mm LED	3713328 023614085423	(3) AAA Alkaline	High: 10 hours Medium: 18 hours SS LED: 32 hours	High: 45 Medium: 30 SS LED: 10	High: 40 meters Medium: 30 meters SS LED: 10 meters	29.99
<b>NEW</b> Pro Hunter Maxus Headlamp, Black	(1) Cree XP-C (2) Green 5mm (2) Red 5mm	3713329 023614085430	(3) AAA Alkaline	High: 6 hours Medium: 10 hours Green, Red: 30-45 hours	High: 85 Medium: 50 Green, Red: 6-8	High: 80 meters Low: 60 meters Green, Red: 15 meters	39.99



**RENEGADE HEADLAMPS**

# RENEGADE

- Ultralight, ultrabright headlamps with powerful distance beams and colored LEDs for long battery life, stealth and improved night vision
- New Nichia® white LEDs are twice as bright as the previous generation of LEDs
- White, red or green LEDs, plus flashing mode
- Wear as a headlamp or clip to your hat
- Brightness: 50 lumens; WRG (white, red, green) LED: 25 lumens
- Effective distance: 40 meters; WRG (white, red, green) LED: 30 meters



DESCRIPTION	LED	CODE #/UPC #	BATTERIES	BATTERY LIFE	LUMENS	SUGG. RETAIL
Renegade 5 LED Headlamp, MONBU	5mm LEDs (2) White (2) Red, (1) Green	3718141 023614203773	(3) AAA Alkaline	(2) Red, (2) White: 18h (1) Green: 50h	25	\$39.99
Renegade 5 LED Headlamp, MONBU	(5) 5mm White LEDs	3718171 023614187264	(3) AAA Alkaline	(5) LEDs: 8h; (3) LEDs: 14h (1) LED: 32h	50	39.99

**PHANTOM HEADLAMP**

# PHANTOM



The Phantom headlamp is the smallest, most powerful AA headlamp in our line-up. It is lightweight and compact, featuring a flip-down diffuser that softens light into a flood beam for up close tasks. A comfortable elastic headstrap and easy-to-use hat clip are included.

- Our brightest, lightest weight headlamp
- Only 2.4 oz. including single AA battery
- Choose between red, green or blue LEDs, plus a powerful Luxeon® white LED for distance
- Pivoting optical diffuser for flood lighting
- Clips to a cap or use with headstrap
- Brightness: 50 lumens
- Effective distance: 70 meters

DESCRIPTION	LED	CODE #/UPC #	BATTERIES	BATTERY LIFE	LUMENS	SUGG. RETAIL
Phantom, MOBU	Luxeon Rebel + (1) Red, (1) Green, (1) Blue 5mm	3718343 023614172734	(1) AA Alkaline	Rebel LED: 1.5 hours 5mm LEDs: 25 hours	50	\$44.99

**MICROBLAST HEADLAMP**

# MICROBLAST

- Ultralight headlamp is super bright and so small it goes unnoticed when worn
- Two Nichia® white LEDs for distance and general-purpose use, one green LED for stealth, safety and night vision
- Rugged polymer construction with Silent Hinge™
- Includes headstrap for use as a headlamp, or hat clip to attach to a cap
- Brightness: 10 lumens
- Effective distance: 15 meters



DESCRIPTION	LED	CODE #	UPC #	BATTERIES	BATTERY LIFE	LUMENS	SUGG. RETAIL
MicroBlast Headlamp	(2) 5mm Nichia White, (1) Green LED	3712121	023614078234	(2) 2032 Lithium	White LEDs: 5 hours Green LED: 33 hours	10	\$14.99



**NIGHT SEEKER RGB CAP LIGHT**

The Night Seeker™ RGB cap light features two white LEDs plus a cool RGB LED which shines first red, then green, then blue — all from a single LED — just by pushing the switch. Like other Night Seeker Lights, the RGB is made from lightweight polymer with an integrated clip that swivels to allow the light to be directed easily.



- Adjustable tilt allows the light to pivot up and down to aim the light where it is needed
- Two white LEDs for all-purpose use
- One RGB LED offers night vision, safety and stealth
- Wear on the brim of a cap, as a pocket light or on a pack strap
- LEDs are rated for 100,000 hours use
- Brightness: 15 lumens
- Effective distance: 20 meters

DESCRIPTION	LED	CODE #	UPC #	BATTERIES	BATTERY LIFE / LUMENS	SUGG. RETAIL
Night Seeker RGB, MONBU	(2) Nichia 5mm + (1) 5mm RGB	3715100	023614080862	(2) 2032 Lithium	White LEDs: 6.5 hours / 15	\$11.99



**NIGHT SEEKER PRO CAP LIGHT**

3715099



- Adjustable tilt allows the light to pivot up and down to aim the light where it is needed
- One Nichia® 0.5 Watt LED for distance illumination
- Two green LEDs for night vision, safety and stealth
- Wear on the brim of a cap, as a pocket light or on a pack strap
- LEDs are rated for 100,000 hours use
- Brightness: 20 lumens
- Effective distance: 35 meters

3715081



**NIGHT SEEKER CAP LIGHT**

- Adjustable tilt allows the light to pivot up and down to aim the light where it is needed
- Two white LEDs are ideal for all-purpose use; one red LED for night vision and stealth
- Wear on the brim of a cap, as a pocket light or on a pack strap
- LEDs are rated for 100,000 hours use
- Brightness: 15 lumens
- Effective distance: 20 meters

Night Seeker™  
**PRO** Cap Light

Cap lights are one of the best ideas ever, and we have the best executed designs available. Night Seeker™ cap lights are durably constructed from a lightweight polymer to keep weight to a minimum. An integrated clip swivels to allow the light to be directed easily. The unique clip is also highly versatile. In addition to attaching to the brim of a cap, the clip can be attached to your shirt pocket, backpack strap or folded out to allow the light to stand on its own.

Night Seeker™

DESCRIPTION	LED	CODE #	UPC #	BATTERIES	BATTERY LIFE / LUMENS	SUGG. RETAIL
Night Seeker Pro, Black	Nichia 0.5 Watt + (2) 5mm Green	3715099	023614074557	(1) AAA Alkaline	0.5W LED: 1.5 hours / 20	\$14.99
Night Seeker Cap Light, Black	(2) 5mm White, (1) Red	3715081	023614205135	(2) 2032 Lithium	White LEDs: 6.5 hours / 15	9.99



**CHOKE TUBE LED KEYCHAIN LIGHTS**

**NEW**

- Nichia® high-intensity white LED
- O-ring sealed for water resistance
- Rugged aircraft-grade aluminum construction
- Twist-switch for easy lock on and off
- Length: 1 3/8"
- Includes four LR41 batteries
- Metal clip
- Brightness: 12 lumens
- Effective distance: 20 meters

*Midas*

*Goose Band*

*Full Strut*



Styled after Browning choke tubes, these handy keychain lights are small enough to go anywhere with you. A bright LED offers suitable light for small tasks and offers up to 8 hours of continuous run time.

DESCRIPTION	LED	BATTERIES	BATTERY LIFE	LUMENS	SUGG. RETAIL
<b>NEW</b> Midas	(1) Nichia White LED	(4) LR41	Up to 8 hours	12	\$9.99
<b>NEW</b> Goose Band	(1) Nichia White LED	(4) LR41	Up to 8 hours	12	9.99
<b>NEW</b> Full Strut	(1) Nichia White LED	(4) LR41	Up to 8 hours	12	9.99

**ECHO KEYCHAIN LIGHTS**

The bright, easy to carry Echo keychain lights clip to a keychain and feature a long-lasting LED plus momentary and lock-on functions.

- Nichia® 5mm white LED
- Ultralight 1/2 oz. weight
- Two replaceable 2016 lithium batteries included
- Rugged polymer construction with rubber side grips and push-button
- Brightness: 12 lumens
- Effective distance: 18 meters



DESCRIPTION	LED	CODE #	UPC #	BATTERIES	BATTERY LIFE	LUMENS	SUGG. RETAIL
Black	(1) 5mm White	3713389	023614079132	(2) 2016 Lithium	Up to 9 hours	12	\$7.99
MONBU	(1) 5mm White	3713390	023614079149	(2) 2016 Lithium	Up to 9 hours	12	9.99



**BUCK MARK 6D LANTERN**



There isn't a better camp lantern than the Buck Mark 6D. The light source is a replaceable fluorescent bulb which puts out 350 lumens for 12 hours, perfect for use around camp and general purpose lighting, or turn it on to the economy setting (140 lumens / 20 hours). The second light source is a 0.5 watt white LED that will run for 168 hours (7 days) when long-term lighting, such as in an emergency situation, is needed. The third light source is a pair of 5mm red LEDs that will run for 264 hours (11 days) for stealth lighting or reading a map and long-term use as a marker, a night light or hanging in the tent. The red LEDs can also be set to blinking mode in an emergency.

- Bright fluorescent and LED lantern
- Steady on and flashing modes
- Durable polymer and metal construction with rubber accents for durability
- Brightness: 350 lumens (Fluorescent)
- Height: 9.25"

**FLASHLIGHT POUCHES**

DESCRIPTION	CODE #/UPC #	SUGG. RETAIL
Small Flashlight Pouch, Black	3749200 023614041054	\$9.99
Large Flashlight Pouch, Black	3749300 023614041061	11.99

- Rugged Cordura® nylon (Lights not included)
- Full range of adjustments using hook and loop fasteners and a polymer snap buckle
- Large pouches fit flashlights up to 6.6"
- Small pouches fit flashlights up to 5"



DESCRIPTION	LED	CODE #	UPC #	BATTERIES	BATTERY LIFE	SUGG. RETAIL
Buck Mark Lantern	Fluorescent; 0.5 Watt; (2) Red 5mm	3717204	023614080725	(6) D Alkaline (not included)	F: 12h; 0.5W: 168 hours; (2) Red LEDs: 264 hours	\$79.99

**BROWNING ALL-TEMPERATURE LITHIUM BATTERIES**

CR123A Batteries



2032 Lithium Batteries

- Lithium batteries deliver about twice the power per gram as alkaline batteries, and don't decline in power output as the batteries are consumed like alkaline
- CR123A Batteries operate from -40° F to 140° F
- 10-year shelf life

DESCRIPTION	CODE #	UPC #	SUGG. RETAIL
CR123A Batteries (2-pack)	3742000	023614188179	\$5.99
2032 Batteries (4-Pack)	3742100	023614078326	4.99

**REPLACEMENT BULBS**

MODEL	DESCRIPTION	BULB	CODE #/ UPC #	SUGG. RETAIL
5000	EXO 9V Flashlight	Xenon 7.2V, 0.75A	3745000 023614184843	\$7.99
5510	Magnum 9V Flashlights	Xenon 8.4V, 1A	3745510 023614205142	7.99
8000	Dakota 4.5V Headlamp	Xenon 3V, 0.3A	3748000 023614186311	7.99
7200	Buckmark Lantern	13 Watt Fluorescent	3747200 023614080855	22.49

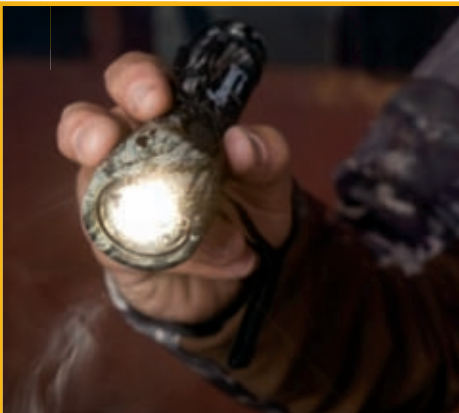



# CLOTHING

## CLOTHING INDEX

### ADDHEAT

Battery Pack/Control Module	200
Soft-Shell AddHeat	200
Vehicle Charger	200

### BLAZE

Big Country Vest	224
Caps	245
Hell's Canyon	204
Safety Vest	224

### BIG GAME

4X Microfleece	210
650 Down	213
700 Fill Power Down	195
Blaze	204
Dillon WindKill	197
Deluge	198
Full Curl Wool	214-217
Hell's Canyon	204-205
Highlands II Wool	218-219
Hydro-Fleece PrimaLoft/Soft Shell	189-191
Illusion	196
Maxus HMX Jacket	199
TF-300 Fleece	211
Transitions Series	192-199
Wasatch	220-223
XPO Big Game	201-203

### CAPS AND HATS

Camo	245-247
Casual	243-244
Felt Hats	247
Safety	245
Wax Fabric	244

### DOWN

650 Down	213
700 Fill Power Down	195
Santa Fe Down Jacket	212

### FIELDWEAR

Illusion	196
Wasatch	220-223

### FOR HER

Full Curl Wool	216
Mohave Short Sleeve Shirt	239
Sporter II Shooting Vest	239
Trapper Creek Shooting Gloves	242
Wasatch	222
XPO Big Game	203

### JUNIOR

Safety Vest	224
Dusty Mesh Shooting Vest	237
TF-300 Fleece	211
Wasatch	222
XPO Big Game	203

### SHOOTING CLOTHING

Badger Creek Shirts	241
Ballistic Insulated Shooting Jacket	242
Broken Birds Vest	238
Deluxe Mesh Vest	240
Dusty Mesh Vest	237
Leather Tac-Pro Gloves	242
Mesh Back Shooting Gloves	242
Mohave Short Sleeve Shirts	239, 241
Reactor Pad, Harness and Shirt	236
Santa Fe Pro Vest	240
Sporter II Vest For Her	239
SXS Vest	240
Trapper Creek Half Vest	238
Trapper Creek Mesh Gloves	242

### SIZING CHART



**TRANSITIONS**  
base • insulation • protection

### TRANSITIONS SERIES

700 Fill Power Down	195
NTS Pro	193
Comfort Fleece	194
Deluge	198
Dillon WindKill	197
Maxus HMX Jacket	199

NTS Pro	199
PrimaLoft	195

### TRANSITIONS: BASE LAYER

NTS Pro	193
---------	-----

### TRANSITIONS: INSULATION LAYER

PrimaLoft	195
700 Fill Power Down	195

### TRANSITIONS: PROTECTION LAYER

Deluge	198
Dillon	197
Illusion	196
Maxus HMX Jacket	199

### UPLAND CLOTHING

Bird'n Lite	228-231
Cross Country	232
Cross Country Upland Pro	233
Dove Polo Shirts	235
Game Vests and Bags	235
Pheasants Forever	225-231
Prairielands Shirts	234
Sweatshirts and Sweaters	223

### WATERFOWL

4X Microfleece	210
650 Down	212-213
700 Fill Power Down	195
Deluge	198
Maxus HMX Jacket	199
PrimaLoft Liner Jacket	195
Transitions	194-196
Warm Front	209
Wasatch	220-221, 223
Windcutter	209
Wing-Set Jacket	208
XPO Grand Passage	206-207

### WOOL

Full Curl	214-217
Highlands II	218-219

### DECALS

Buckmark	248
----------	-----





# HMX™

## THE NEXT GENERATION OF WATERPROOF/BREATHABLE

**NEW**

### NEW HMX BI-COMPONENT WATERPROOF BREATHABLE FABRIC TECHNOLOGY IS HERE

For 2011, Browning introduces new high performance, Bi-Component HMX waterproof and breathable fabrics. HMX is different because it combines the advantages of the two most widely used technologies. Hydrophilic Monolithic systems do not transport perspiration vapor, but only the liquid perspiration formed when the vapor condenses. Hydrophobic Microporous systems transport vapor, but do not transport condensed perspiration. By using a Bi-Component System we utilize the advantages of both technologies to move both water vapor and condensed water to the outside of the garment keeping you protected from internal moisture. At the same time, HMX totally prevents water entry from the outside. The revolutionary Bi-Component technology found in HMX fabrics provides the level of protection and comfort you have come to expect from Browning Technical Clothing, The Best There Is.

**HMX™**

A) Wicks moisture away.  
B) Pumps away perspiration.

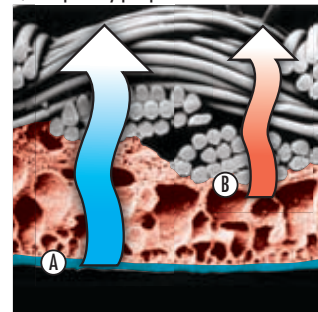

BI-COMPONENT Waterproof breathable fabric  
(Shown magnified 300 times)

## STAY WARMER WITH NEW PRIMALOFT® SPORT INSULATION

**PRIMALOFT®**  
sport

Being cold is a thing of the past with the addition of PrimaLoft® Sport insulation to the Browning Technical Clothing line-up. PrimaLoft Sport is a premium performance, fine-fiber, high-loft insulation engineered to keep you warmer, drier and more comfortable in extreme conditions — even if it gets wet. PrimaLoft is so good, it was chosen by the US Military with over 1,000,000 PrimaLoft military garments deployed in Iraq and Afghanistan.

**NEW**

### WHAT MAKES PRIMALOFT® SO GOOD?

- PrimaLoft® Sport is a premium performance insulation engineered for superior warmth, water resistance, loft, softness and compressibility.
- PrimaLoft fibers are the finest in the industry and are densely packed to retain heat better for improved thermal efficiency
- PrimaLoft fibers are specially treated to repel water molecules and absorb less water to make PrimaLoft more water-resistant and faster drying than other polyester insulations
- The tightly-compressed fibers make PrimaLoft highly wind-resistant
- The smaller, finer fibers compress more and are lighter, less bulky, more breathable and extremely compressible

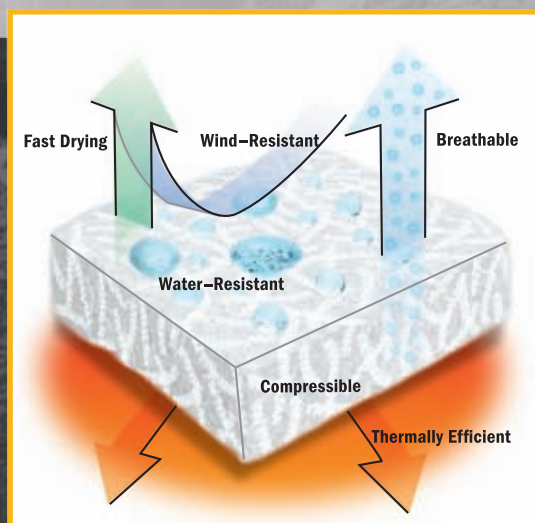





# THE RETURN OF BROWNING® HYDRO-FLEECE — THE BEST THERE IS.

When Browning Hydro-Fleece was first introduced in 1993, it was a game changer, totally different than anything else in the hunting clothing market. Hydro-Fleece was the first truly technical outdoor gear offered in the hunting industry with the ideal combination of quiet, waterproof, windproof and breathable protection. Hunters clamored for it and Hydro-Fleece quickly became the standard by which all other hunting garments were compared to.

For 2011 we've put some new twists on this favorite with the re-introduction of Hydro-Fleece, now updated and better than ever to make it the go-to hunting clothing when you're looking for the ultimate in quiet, waterproof protection. Hydro-Fleece now includes innovative new technology that provides improved performance.

These innovations not only make new Browning Hydro-Fleece better than before, they make it better than anything else on the market. Now add fully-taped seams that reliably waterproof critical areas, gear-swallowing pockets, adjustable hoods and cuffs, sturdy zippers and a performance fit that won't restrict your range of motion. If you are seeking the ultimate technical hunting clothing, look no further than Hydro-Fleece from the most trusted name in the technical clothing business, Browning.

- New softer, quieter Hydro-Fleece fabric with an improved water shedding treatment on the fabric surface
- New HMX bi-component waterproof and breathable fabric for the ultimate in protection and comfort
- New insulated models feature ultra warm, quiet and lightweight PrimaLoft® Sport insulation that provides the highest warmth-to-weight ratio of any synthetic insulation
- Updated models and features including 2-layer and 3-layer soft shells.
- OdorSmart™ anti-microbial lining helps control the bacteria that causes human odors
- Mossy Oak® Break-Up® Infinity™ camouflage

**NEW**



## HYDRO-FLEECE — THE BEST IS BACK. AND BETTER THAN EVER.

**NEW**

2-layer Hydro-Fleece with PrimaLoft® Sport insulation models are the warmest hunting parkas, jackets and pants we offer. The combination of the loftier soft shell fabric and thermally efficient PrimaLoft insulation provide a level of protection and comfort never before possible. Four pieces are available including a parka and matching bib and a lighter weight jacket and pant. 3-layer Hydro-Fleece Soft Shell models add a new dimension with a form-fitting design to minimize weight and bulk. The 3-layer fabric features new Hydro-Fleece fabric on the outside with a smooth, fully-taped knit lining on the inside for ease of movement. Jacket and matching pant available.

### HYDRO-FLEECE PRIMALOFT PARKA

New HMX™ waterproof, breathable, bi-component 2-layer shell fabric · Fully-taped seams · OdorSmart™ anti-microbial lining helps control the bacteria that causes human odors · PrimaLoft® Sport insulation · Two laser cut chest pockets with zippered closures · Two oversized bellows pockets with magnetic flap closures · Two handwarmer pockets behind bellows pockets · Two inside pockets · Waist drawcord · Laminated watertight cuff closures with hook and loop adjustment · Detachable hood with drawcord adjustment and molded brim · Full-length front closure using 2-way Waterguard™ zipper · Laminated internal zipper flap · Stand-up, zip-through collar · License tab · Sizes: S-3XL

NUMBER	DESCRIPTION	S	M	L	XL	2XL	3XL	SUGG. RETAIL
30394220	<b>NEW</b> Mossy Oak Break-Up Infinity							\$300.00
								\$327.00







### WHAT DOES IT MEAN TO BE WATERPROOF?

Here's what makes Browning waterproof and breathable clothing different from many of our competitors:

- **Waterproof fabrics:** HMX™ and Pre-Vent® fabrics have been specially created to meet our very high standards for waterproofness and breathability. Since shell fabrics are your first defense against the elements, we don't cut corners on quality.
- **Taped Seams:** Every seam is taped or we don't call it "waterproof." End of story. We are very involved in developing the correct tape and using only manufacturers who have years of experience taping garments.
- **Construction:** Browning waterproof garments are designed and constructed to resist water entry at all closures including cuffs, hoods, pockets and zippers. The Browning name is your assurance that corners are not cut for the sake of cost. When you see the HMX or Pre-Vent labels in Browning garments you know you can rely on them to perform to the highest standards.



**NEW**

A ▶ PrimaLoft® Jacket Break-Up® Infinity™



**NEW**

B ▶ Soft Shell Jacket Break-Up® Infinity™

### HYDRO-FLEECE PRIMALOFT® JACKET

New HMX™ waterproof, breathable, bi-component 2-layer shell fabric · Fully-taped seams · OdorSmart™ anti-microbial lining helps control the bacteria that causes human odors · PrimaLoft® Sport insulation · Chest pocket with zipper closure · Two handwarmer pockets with zipper closures · Internal security pocket with zipper closures · Bottom drawcord adjusts from inside handwarmer pockets · Internal sleeve cuffs · Detachable hood with drawcord adjustment and molded brim · Full-length front closure using two-way Waterguard™ zipper · Laminated internal zipper flap · Stand-up, zip-through collar · License tab · Sizes: S-3XL

NUMBER	DESCRIPTION	S	M	L	XL	2XL	3XL	SUGG. RETAIL
A ▶ 30494220	<b>NEW</b> Mossy Oak Break-Up Infinity							\$268.00
						S-XL		292.00
						2XL-3XL		

### HYDRO-FLEECE SOFT SHELL JACKET

New HMX™ waterproof, breathable, bi-component 3-layer soft shell fabric · OdorSmart™ anti-microbial lining helps control the bacteria that causes human odors · Fully-taped seams using matching 3-layer tape · Backpack friendly handwarmer pockets · Zippered inside security pocket · Bottom drawcord adjusts from inside handwarmer pockets · Laminated watertight cuffs with hook and loop adjustment · Attached hood rolls up and stores behind collar · Full-length two-way front closure with Waterguard™ zipper · Laminated internal zipper flap · License tab · Sizes: S-3XL

NUMBER	DESCRIPTION	S	M	L	XL	2XL	3XL	SUGG. RETAIL
B ▶ 30494420	<b>NEW</b> Mossy Oak Break-Up Infinity							\$232.00
								256.00
						S-XL		
						2XL-3XL		







D ▶ PrimaLoft® Pant  
Break-Up® Infinity™



C ▶ PrimaLoft® Bib  
Break-Up® Infinity™



E ▶ Soft Shell Pant  
Break-Up® Infinity™

### HYDRO-FLEECE PRIMALOFT® BIB

New HMX™ waterproof, breathable, bi-component 2-layer shell fabric · Fully-taped seams · OdorSmart™ anti-microbial lining helps control the bacteria that causes human odors · PrimaLoft® Sport insulation · Full-length, side seam two-way zippers with storm flaps · Rib knit side vent gussets · Elasticized suspenders with cam lock buckle · Rear zippered pocket · Zippered front opening with two-way zipper and storm flap · Sizes: S-3XL

NUMBER	DESCRIPTION	S	M	L	XL	2XL	3XL	SUGG. RETAIL
C ▶ 30694220	NEW Mossy Oak Break-Up Infinity						S-XL 2XL-3XL	\$210.00 232.00

### HYDRO-FLEECE PRIMALOFT® PANT

New HMX™ waterproof, breathable, bi-component 2-layer shell fabric · Fully-taped seams · OdorSmart™ anti-microbial lining helps control the bacteria that causes human odors · PrimaLoft® Sport insulation · Differential cut waistband is higher in the back to prevent drafts when sitting · Zippered fly · Two front pockets, two zippered cargo pockets and one rear pocket · Zip-to-knee cuff openings · Belt loops · Sizes: S-3XL

NUMBER	DESCRIPTION	S	M	L	XL	2XL	3XL	SUGG. RETAIL
D ▶ 30294220	NEW Mossy Oak Break-Up Infinity						S-XL 2XL-3XL	\$175.00 198.00

### HYDRO-FLEECE SOFT SHELL PANT

New HMX™ waterproof, breathable, bi-component 3-layer soft shell fabric · OdorSmart™ anti-microbial lining helps control the bacteria that causes human odors · Fully-taped seams using matching 3-layer tape · Differential cut waistband is higher in the back to prevent drafts when sitting · Zippered fly · Two front pockets, two zippered cargo pockets and one rear pocket · Padded articulated knees · Zip-to-knee cuff openings · Belt loops · Sizes: S-3XL

NUMBER	DESCRIPTION	S	M	L	XL	2XL	3XL	SUGG. RETAIL
E ▶ 30294420	NEW Mossy Oak Break-Up Infinity						S-XL 2XL-3XL	\$198.00 222.00



**TRANSITIONS — AWARD WINNING PROTECTION**

Since its introduction in 2008, the Browning Transitions series has won two prestigious awards for design excellence and performance in the field: “Best of the Best” from *Field and Stream* and the “Award of Excellence” from *Sporting Classics*. We are proud of these accomplishments, but we won't sit back on our laurels. We have overhauled many Transitions models for 2011 to keep them on the leading edge of performance, plus we've added new models that bring even more versatility and excitement to the line.

For 2011, all waterproof, breathable models in the Protection Layer feature HMX™ bi-component fabrics for extreme waterproofness and high breathability for maximum comfort. We have also added a new PrimaLoft Liner Jacket to the insulation category for a new dimension of warmth in the Insulation Layer. The great layering concept represented by the Transitions models continue to make it one of the most versatile apparel assortments available by combining Base, Insulation and Protection layers, all utilizing leading-edge technology.



**BASE layer**

Base layers wick perspiration away from the skin and keep you warm and dry, not cold and clammy, even when moving. Anti-microbial technology is added to Big Game garments to control the growth of odor-causing bacteria to reduce human odor.



**INSULATION layer**

Insulation layers are available to meet specific needs based on weather conditions and activity level. In dry weather, Layer 2 garments make excellent outer pieces. Choose from down or PrimaLoft® models.



**PROTECTION layer**

The Protection layer is the first line of defense against wind, rain and snow. Layer 3 garments are designed to maximize protection with minimal bulk. Choose one of several styles featuring new HMX™ or WindKill™ models.



**TRANSITIONS®**  
base · insulation · protection





A ▶ NTS Pro Top  
Break-Up®  
Infinity™



**TRANSITIONS®**  
base · insulation · protection

### NTS PRO BASE LAYER — A SOLID FOUNDATION FOR WARMTH.

Featuring VisaEndurance® anti-microbial fabric, NTS (Next To Skin) Pro Base Layer gear with OdorSmart™ technology is designed to provide advanced odor control. OdorSmart features patented encapsulated silver ion technology that inhibits the growth of odor-causing bacteria to help prevent body odors. Encapsulated silver ions work for the life of the garment, with no loss of effectiveness even after repeated washings. The wicking fabric effectively transports moisture away from the body where it quickly evaporates to keep you dry and comfortable. A lighter weight fabric under the arm enhances breathability. NTS is a solid foundation for controlling human odor and maintaining comfort on your next adventure.



VISAENDURANCE®



ODORSMART™



B ▶ NTS Pro Bottom  
Break-Up®  
Infinity™

«NTS»  
NEXT TO SKIN

#### NTS PRO TOP

Midweight 100% microdenier polyester fabric · Trim fabric under the arms and down the sides is constructed of bird's-eye mesh for added breathability · OdorSmart™ technology featuring VisaEndurance® silver ion anti-microbial fabric to help control human odor · Perfect when odor control is a must · Excellent moisture transfer · Dries quickly · Loose fit · Double-stitch neck for comfort · Sizes: S-2XL

NUMBER	DESCRIPTION	S	M	L	XL	2XL	SUGG. RETAIL
A ▶ 30116920	MOINF					S-2XL	\$50.50
30116917	<b>NEW</b> Duck Blind					S-2XL	50.50

#### NTS PRO BOTTOM

Midweight 100% microdenier polyester fabric · OdorSmart™ technology featuring VisaEndurance® silver ion anti-microbial fabric to help control human odor · Perfect where odor control is a must · Excellent moisture transfer · Dries quickly · Loose fit · Front fly · Elastic waist · Sizes: S-2XL

NUMBER	DESCRIPTION	S	M	L	XL	2XL	SUGG. RETAIL
B ▶ 30216920	MOINF					S-2XL	\$50.50
30216917	<b>NEW</b> Duck Blind					S-2XL	50.50





**TRANSITIONS®**  
base · insulation · protection



**B ▶** Top  
Treestand®

**COMFORT FLEECE — WARMTH ANYTIME.**

Designed as a base layer, Comfort Fleece is so soft and warm you'll want to wear it while lounging at home. The lightweight, 200 gram fleece offers a tremendous amount of warmth with minimal bulk and breathes like it has its own set of lungs. The mock neck top snugs up to seal in heat, and the bottoms have a tapered fit with stirrups to keep them in place when putting on waders. Make Comfort Fleece your foundation layer for protection from the cold.

**COMFORT FLEECE TOP**

Lightweight 200 gram fleece is brushed on both sides for additional warmth and comfort · Generous cut · Mock neck design · Sizes: S-3XL

NUMBER	DESCRIPTION	S	M	L	XL	2XL	3XL	SUGG. RETAIL
<b>A ▶</b> 30111817	Mossy Oak Duck Blind						S-XL 2XL-3XL	\$38.00 45.00
<b>B ▶</b> 30111818	<b>NEW</b> Mossy Oak Treestand						S-XL 2XL-3XL	38.00 45.00

**A ▶** Top  
Duck Blind®

**COMFORT FLEECE BOTTOM**

Lightweight 200 gram fleece is brushed on both sides for additional warmth and comfort · Generous cut · Tapered leg · Elastic waistband · Elastic stirrups · Zippered fly · Sizes: S-3XL

NUMBER	DESCRIPTION	S	M	L	XL	2XL	3XL	SUGG. RETAIL
<b>C ▶</b> 30211817	Mossy Oak Duck Blind						S-XL 2XL-3XL	\$45.00 51.00
30211818	<b>NEW</b> Mossy Oak Treestand						S-XL 2XL-3XL	45.00 51.00

**C ▶** Bottom  
Duck Blind®





**NEW**



**D ▶** PrimaLoft® Liner Jacket  
Duck Blind®



**TRANSITIONS®**  
base · insulation · protection

**PRIMALOFT® — WARMER, DRIER, SOFTER.**

Looks can be deceiving. At first glance the new Browning PrimaLoft® Liner Jacket is just another insulated jacket. In reality, it is much more. The combination of superfine PrimaLoft® Sport insulation and highly-constructed shell and lining fabrics provide unbelievable warmth with minimal weight or bulk. Unlike down, PrimaLoft® Sport continues to insulate even when wet, and dries incredibly fast. When you layer it under a waterproof shell, it offers incredible protection from cold, wet weather. Because of its lightweight comfort and warmth, you may find yourself wearing it alone in less demanding weather. Zip-off sleeves quickly convert the jacket into a vest for greater versatility. Jacket stuffs into the chest pocket.

**PRIMALOFT® LINER JACKET WITH ZIP-OFF SLEEVES**

PrimaLoft® Sport insulation offers optimum warmth · Featherweight shell and liner fabric · Zippered chest pocket doubles as a stuff bag · Two zippered handwarmer pockets · Drawcord waist · Lycra® cuffs · Zip-off sleeves · Stand-up collar · Sizes: S-3XL

NUMBER	DESCRIPTION	S	M	L	XL	2XL	3XL	SUGG. RETAIL
30482320	<b>NEW</b> Mossy Oak Break-Up Infinity							S-XL \$122.00 2XL-3XL 134.00
<b>D ▶</b> 30482317	<b>NEW</b> Mossy Oak Duck Blind							S-XL 122.00 2XL-3XL 134.00
30482342	<b>NEW</b> Olive							S-XL 110.00 2XL-3XL 122.00

**700 FILL POWER DOWN JACKET**

700 fill power goose down insulation provides maximum warmth with the least weight and bulk · Backpack friendly design provides easy access to pockets · Lycra® cuff and hem · Contrasting side stripe · Stuffs into internal pocket · Sizes: S-3XL

NUMBER	DESCRIPTION	S	M	L	XL	2XL	3XL	SUGG. RETAIL
<b>E ▶</b> 30476620	Mossy Oak Break-Up Infinity							S-XL \$159.00 2XL-3XL 171.00
30476618	Mossy Oak Treestand							S-XL 159.00 2XL-3XL 171.00
30476617	Mossy Oak Duck Blind							S-XL 159.00 2XL-3XL 171.00
30476632	Tan							S-XL 147.00 2XL-3XL 159.00
30476642	Olive							S-XL 147.00 2XL-3XL 159.00

**700 FILL POWER DOWN VEST**

700 fill power goose down insulation provides maximum warmth with the least weight and bulk · Backpack friendly design provides access to pockets · Lycra® hem · Contrasting side stripe · Stuffs into internal pocket · Sizes: S-3XL

NUMBER	DESCRIPTION	S	M	L	XL	2XL	3XL	SUGG. RETAIL
30576720	Mossy Oak Break-Up Infinity							S-XL \$122.00 2XL-3XL 134.00
30576718	Mossy Oak Treestand							S-XL 122.00 2XL-3XL 134.00
30576717	Mossy Oak Duck Blind							S-XL 122.00 2XL-3XL 134.00
30576732	Tan							S-XL 116.00 2XL-3XL 128.00
<b>F ▶</b> 30576742	Olive							S-XL 116.00 2XL-3XL 128.00



**E ▶** Jacket  
Break-Up® Infinity™



**F ▶** Vest  
Olive





**TRANSITIONS**  
base - i protection



**ILLUSION — PURSUING PERFECTION.**

Illusion combines the ruggedness, quietness and comfort of a soft shell with our new HMX™ bi-component waterproof, breathable fabric for the ultimate in hunting gear. Every seam has been sealed with matching 3-layer tape to make Illusion models truly waterproof for reliability and protection in the nasty conditions you often hunt in. OdorSmart™ anti-microbial treatment keeps human scent to a minimum. The form-fitting jacket minimizes bulk and weight and is backpack friendly, allowing you to access the pockets when wearing a pack. The pant moves easily with you, making it ideal for stalking game.



A ▶ Jacket Break-Up® Infinity™

**NEW**



**BACKPACK FRIENDLY**

**HMX**



**NEW**



B ▶ Pant Break-Up® Infinity™

**HMX**

**ILLUSION SOFT SHELL JACKET**

New HMX™ waterproof, breathable, bi-component 3-layer soft shell fabric · OdorSmart™ anti-microbial lining helps control the bacteria that causes human odors · Fully-taped seams using matching 3-layer tape · Backpack friendly design provides easy access to handwarmer pockets · Inside security pocket · Bottom drawcord adjusts from inside handwarmer pockets · Laminated watertight cuffs with hook and loop adjustment · Hood rolls up and stores behind collar · Full-length front closure with Waterguard™ zipper · Laminated internal zipper flap · Stand-up, zip-through collar · License tab · Sizes: S-3XL

NUMBER	DESCRIPTION	S	M	L	XL	2XL	3XL	SUGG. RETAIL
A ▶ 30487420	<b>NEW</b> Mossy Oak Break-Up Infinity							S-XL \$245.00 2XL-3XL 269.00
30487418	<b>NEW</b> Mossy Oak Treestand							S-XL 245.00 2XL-3XL 269.00

**ILLUSION SOFT SHELL PANT**

New HMX™ waterproof, breathable, bi-component 3-layer soft shell fabric · OdorSmart™ anti-microbial lining helps control the bacteria that causes human odors · Fully-taped seams using matching 3-layer tape · Differential cut waistband is higher in the back to prevent drafts when sitting · Belt loops · Zippered fly · Two front pockets, two zippered cargo pockets and one rear pocket · Zip-to-knee cuff openings · Sizes: S-3XL

NUMBER	DESCRIPTION	S	M	L	XL	2XL	3XL	SUGG. RETAIL
B ▶ 30287420	<b>NEW</b> Mossy Oak Break-Up Infinity							S-XL \$208.00 2XL-3XL 232.00
30287418	<b>NEW</b> Mossy Oak Treestand							S-XL 208.00 2XL-3XL 232.00

**ILLUSION GLOVES**

100% waterproof, windproof and breathable · Design allows for great fit and dexterity · Hook and loop wrist strap · Leather palm and fingers · Moisture-moving lining · Articulated fingers with Sensi-Flex trigger finger for unequalled feel · Sizes: S-XL

NUMBER	DESCRIPTION	S	M	L	XL	SUGG. RETAIL
C ▶ 30787420	<b>NEW</b> Mossy Oak Break-Up Infinity					S-XL \$53.00
30787418	<b>NEW</b> Mossy Oak Treestand					S-XL \$53.00



C ▶ Gloves Break-Up® Infinity™

**ILLUSION**™



**WHAT DOES IT MEAN TO BE WINDPROOF?**

This is what you should know about Browning windproof clothing that makes us different:

- WindKill™ clothing is made from laminated fabric that blocks the passage of wind through the fabric while breathing away perspiration.
- Browning windproof clothing is designed and constructed to prevent wind from sneaking in through cuffs, zippers and hoods. This combination of laminated fabric and design features ensures our clothing is totally windproof, not just wind-resistant.



**TRANSITIONS®**  
base · insulation · protection



**D ▶ Jacket**  
Break-Up® Infinity™

**E ▶ Pant**  
Break-Up® Infinity™



**NEW**

**NEW**

**DILLON WINDKILL JACKET**

100% windproof and highly breathable WindKill™ 3-layer fabric · OdorSmart™ anti-microbial lining helps control the bacteria that causes human odors · Backpack friendly design provides easy access to handwarmer pockets · Inside security pocket · Bottom drawcord adjusts from inside handwarmer pockets · Lycra® cuffs · Full-length front zipper closure internal zipper flap · Fully-lined sleeves · Stand-up, zip-through collar · License tab · Sizes: S-3XL

NUMBER	DESCRIPTION	S	M	L	XL	2XL	3XL	SUGG. RETAIL
<b>D ▶</b> 30485920	<b>NEW</b> Mossy Oak Break-Up Infinity						S-XL 2XL-3XL	\$171.00 183.00
30485918	<b>NEW</b> Mossy Oak Treestand						S-XL 2XL-3XL	171.00 183.00

**DILLON WINDKILL PANT**

100% windproof and highly breathable WindKill™ 3-layer fabric · OdorSmart™ anti-microbial lining helps control the bacteria that causes human odors · Elasticized waist with drawcord and belt loops · Zippered fly · Two front pockets and one rear pocket · Articulated knees · Zip-to-knee cuff openings · Sizes: S-3XL

NUMBER	DESCRIPTION	S	M	L	XL	2XL	3XL	SUGG. RETAIL
<b>E ▶</b> 30285920	<b>NEW</b> Mossy Oak Break-Up Infinity						S-XL 2XL-3XL	\$122.00 134.00
30285918	<b>NEW</b> Mossy Oak Treestand						S-XL 2XL-3XL	122.00 134.00

**DILLON WINDKILL GLOVES**

Shell fabric matches the Dillon clothing · 100% windproof and highly breathable · No-slip palm overlay · Elasticized wrist · Warm fleece lining · Sizes: S-XL

NUMBER	DESCRIPTION	S	M	L	XL	SUGG. RETAIL
<b>F ▶</b> 30785920	<b>NEW</b> Mossy Oak Break-Up Infinity					\$35.00
30785918	<b>NEW</b> Mossy Oak Treestand					35.00



**F ▶ Gloves**  
Break-Up® Infinity™

**NEW**







# MAXUS®



**TRANSITIONS®**  
Insulation - protection

## MAXUS JACKET. THE FINEST WATERFOWL GEAR AVAILABLE.

For 2011 the Maxus jacket has been redesigned with even more features like our revolutionary new HMX™ fabric that provides maximum waterproof protection while transferring perspiration buildup to the outside where it can evaporate. As a stand-alone jacket, it provides protection from rain, sleet and snow with ease. In colder weather it can be layered over a fleece, down or PrimaLoft® liner jacket for insulation from the cold and elements. The lightweight, rugged 3-layer soft shell fabric resists the pokes and sticks with minimal weight. All seams are taped using 3-layer tape to insure total 100% waterproof protection. Serious waterfowlers will appreciate all the features that make this the ultimate waterfowl jacket.

C ▶ Jacket  
Duck Blind®

DETACHABLE HOOD

CALL POCKET

**NEW**

**HMX™**

UPPER HAND  
WARMER POCKETS

OVER-SIZED LOWER POCKETS  
WITH HOOK AND LOOP  
SECURED FLAPS

FREEDOM  
SLEEVE DESIGN

LAMINATED  
WATERTIGHT CUFF

BOTTOM DRAWCORD

**NEW**



D ▶ Gloves  
Duck Blind®

## MAXUS HMX JACKET

New HMX™ waterproof, breathable, bi-component 3-layer fabric · Seams are sealed with matching 3-layer tape · Detachable hood · Bottom drawcord adjusts from inside lower handwarmer pockets · Call pocket on the left chest with zipper closure · Articulated elbow and freedom sleeve design · Two upper chest handwarmer pockets with zipper closures · Two lower bellows pockets with hook and loop secured flaps and handwarmer pockets · Inside security pocket with zipper closure · License tab · Sizes: S-3XL

NUMBER	DESCRIPTION	S	M	L	XL	2XL	3XL	SUGG. RETAIL
C ▶ 30485617	<b>NEW</b> Mossy Oak Duck Blind						S-XL 2XL-3XL	\$293.00 317.00

## MAXUS GLOVES

Pre-Vent® waterproof/breathable glove insert · Hook and loop wrist adjustment tab · Articulated fingers with Sensi-Flex trigger finger for unequalled feel · Sizes: S-XL

NUMBER	DESCRIPTION	S	M	L	XL	SUGG. RETAIL
D ▶ 30785617	<b>NEW</b> Mossy Oak Duck Blind					\$53.00

## MAXUS DECOY GLOVES

Pre-Vent® waterproof/breathable glove insert · Extended elbow-length gauntlet · One-hand adjustable forearm closure · Hook and loop wrist adjustment tab · Articulated fingers with Sensi-Flex trigger finger for unequalled feel · Sizes: S-XL

NUMBER	DESCRIPTION	S	M	L	XL	SUGG. RETAIL
E ▶ 30785617	<b>NEW</b> Mossy Oak Duck Blind					\$53.00



E ▶ Decoy Gloves  
Duck Blind®





**ADDHEAT – TURN IT ON AND GET HEATED UP!**

The new AddHeat Soft Shell Jacket and Vest take heating technology to the next level of performance. The new 2-layer soft shell fabric features a mesh lining with OdorSmart™ anti-microbial technology to help control human odor. The jacket features three individual heating panels for maximum warmth, while the vest has one heating panel to maximize battery life. Either piece functions as an insulating mid-layer, or as an outer layer in less demanding weather.

For 2011 we have also trimmed away excess weight and bulk by combining the compact, rechargeable Li-ion battery pack with the control module into a single unit. The battery pack/control module is sold separately, so you may purchase a single battery pack/control module to use with both AddHeat garments without having a separate AddHeat System for each. The AddHeat System still provides up to 5.5 hours of continuous heat and is controlled by a simple-to-use “intelligent” Micro-CPU controller and 110-220 VAC charger or with an optional 12VDC vehicle charger. Care of an AddHeat garment is simple. Just remove the battery pack/control module and hand wash and line dry the garment as often as necessary. No worries and no hassles.

**Note that the battery pack/control module is not included with AddHeat garments and must be purchased separately.**

A ► Jacket  
Break-Up® Infinity™



B ► Vest  
Olive

**SOFT SHELL ADDHEAT JACKET**

2-layer bonded shell fabric with mesh lining · Three AddHeat panels provide comfortable, even heating · Lycra® cuffs and waist · Flexible heating elements can be washed · AddHeat controller/battery pack sold separately · Sizes: S-3XL

NUMBER	DESCRIPTION	S	M	L	XL	2XL	3XL	SUGG. RETAIL
A ► 30488020	<b>NEW</b> Mossy Oak Break-Up Infinity					S-XL		\$152.00
						2XL-3XL		164.00
30488042	<b>NEW</b> Olive					S-XL		140.00
						2XL-3XL		152.00

**SOFT SHELL ADDHEAT VEST**

2-layer bonded shell fabric with mesh lining · One AddHeat panel provides comfortable heating and maximizes battery life · Lycra® cuffs and waist · Flexible heating elements can be washed · AddHeat controller/battery pack sold separately · Sizes: S-3XL

NUMBER	DESCRIPTION	S	M	L	XL	2XL	3XL	SUGG. RETAIL
30588020	<b>NEW</b> Mossy Oak Break-Up Infinity					S-XL		\$140.00
						2XL-3XL		152.00
B ► 30588042	<b>NEW</b> Olive					S-XL		129.00
						2XL-3XL		140.00

**ADDHEAT BATTERY PACK/CONTROL MODULE**

Consists of control unit and rechargeable Li-ion battery · Intelligent micro-CPU controller maximizes battery life · Four temperature settings (preheat, low, medium, high) · 110-220V AC charger · Not included with AddHeat garments

NUMBER	DESCRIPTION	SUGG. RETAIL
C ► 121019	<b>NEW</b> Power Pack/Control Module	\$85.00

**ADDHEAT 12 VOLT VEHICLE CHARGER**

Allows the battery to be charged from a vehicle

NUMBER	DESCRIPTION	SUGG. RETAIL
D ► 121017	12 Volt Charger	\$16.00

**NEW**



C ► Battery Pack Control Module

D ► 12 Volt Charger



**PRE-VENT**  
GEAR TRIEVER™

**XCHANGE SYSTEM**

**E ▶ 4-in-1 Parka**  
Break-Up® Infinity™

**PRE-VENT**  
**F ▶ Insulated Parka**  
Treestand®  
GEAR TRIEVER™



**PRE-VENT**  
**G ▶ X-Change Jacket**  
Break-Up® Infinity™  
GEAR TRIEVER™



**XCHANGE SYSTEM**



**XPO™**  
XTENDED PERFORMANCE OUTERWEAR

**XPO BIG GAME 4-IN-1 PARKA**

Shell: Pre-Vent® waterproof, breathable shell fabric · Lining has mesh in upper body and nylon taffeta in lower body and arms · Set-in sleeves with one piece, no-seam construction · Articulated elbow for ease of movement · Watertight neoprene cuff with hook and loop tab · Two bellows pockets and handwarmer pockets · Pocket on left chest to accommodate Browning's Gear "Trievers" System · One inside security pocket with zipper closure · Internal waist drawcord · Detachable hood with molded visor, height adjustment drawcord and two button front closure · Two-way front closure with inner and outer storm flaps secured by five snaps · License tab in back · X-Change System compatible **Liner:** Quiet camo shell fabric · Warm insulation · Solid color nylon taffeta lining · Reversible design · Set-in sleeves · Two pockets on each side · Elasticized waist · Rib knit cuffs · Sizes: S-3XL

NUMBER	DESCRIPTION	S	M	L	XL	2XL	3XL	SUGG. RETAIL
<b>E ▶</b> 30369220	Mossy Oak Break-Up Infinity						S-XL	\$232.00
							2XL-3XL	257.00
30369218	Mossy Oak Treestand						S-XL	232.00
							2XL-3XL	257.00

**XPO BIG GAME INSULATED PARKA**

Pre-Vent® waterproof, breathable shell fabric · Warm insulation throughout · Brushed tricot lining · Set-in sleeves with one piece, no-seam construction · Articulated elbow for ease of movement · Watertight neoprene cuffs with hook and loop closure · Two bellows pockets and handwarmer pockets · Pocket on left chest to accommodate Browning's Gear "Trievers" System · One inside security pocket with zipper closure · Adjustable internal bottom drawcord · Detachable hood with molded visor, height adjustment drawcord and two button front closure · Two-way front zipper closure with inner and outer storm flaps secured by five snaps · License tab in back · Sizes: S-3XL

NUMBER	DESCRIPTION	S	M	L	XL	2XL	3XL	SUGG. RETAIL
30368820	Mossy Oak Break-Up Infinity						S-XL	\$187.00
							2XL-3XL	210.00
<b>F ▶</b> 30368818	Mossy Oak Treestand						S-XL	187.00
							2XL-3XL	210.00

**XPO BIG GAME X-CHANGE JACKET**

Pre-Vent® waterproof, breathable shell fabric · Lining has mesh in upper body and brushed tricot in lower body and sleeves · Set-in sleeves with one piece, no-seam construction · Articulated elbow for ease of movement · Watertight neoprene cuffs with hook and loop closure · Two handwarmer pockets with zippered closure · Pocket on left chest to accommodate Browning's Gear "Trievers" System · One inside security pocket with zipper closure · Bottom drawcord that adjusts from inside handwarmer pockets · Detachable hood with molded visor, height adjustment drawcord and two button front closure · Two-way front zipper closure with inner and outer storm flaps secured by five snaps · License tab in back · X-Change System compatible · Sizes: S-3XL

NUMBER	DESCRIPTION	S	M	L	XL	2XL	3XL	SUGG. RETAIL
<b>G ▶</b> 30469320	Mossy Oak Break-Up Infinity						S-XL	\$164.00
							2XL-3XL	181.00
30469318	Mossy Oak Treestand						S-XL	164.00
							2XL-3XL	181.00



**XPO BIG GAME PANT**

Pre-Vent® waterproof, breathable shell fabric · Brushed tricot lining · Differential cut waistband is higher in the back to prevent drafts when sitting · Grip strip waistband with suspender buttons · Belt loops · Zippered fly · Two front pockets, two zippered cargo pockets and one rear pocket · Zip-to-knee cuff openings with storm flaps · Sizes: S-3XL

NUMBER	DESCRIPTION	S	M	L	XL	2XL	3XL	SUGG. RETAIL
A ▶ 30269620	Mossy Oak Break-Up Infinity							S-XL \$117.00 2XL-3XL 129.00
30269618	Mossy Oak Treestand							S-XL 117.00 2XL-3XL 129.00

**XPO BIG GAME INSULATED BIB**

Pre-Vent® waterproof, breathable shell fabric · Brushed tricot lining · Full-length, side seam two-way zippers with storm flaps · Rib knit side vent gussets · Elasticized suspenders with cam lock buckle · Rear zippered pocket · Zippered front opening with two-way zipper and storm flap · ThermoLite® insulation · Sizes: S-3XL

NUMBER	DESCRIPTION	S	M	L	XL	2XL	3XL	SUGG. RETAIL
30669420	Mossy Oak Break-Up Infinity							S-XL \$152.00 2XL-3XL 169.00
B ▶ 30669418	Mossy Oak Treestand							S-XL 152.00 2XL-3XL 169.00

**XPO BIG GAME PRIMALOFT GLOVE**

Shell fabric matches XPO™ Big Game clothing · 100% waterproof, windproof and breathable · No-slip palm · Fully insulated · Elasticized wrist · Moisture moving lining · Fully insulated with PrimaLoft · Sizes: S-XL

NUMBER	DESCRIPTION	S	M	L	XL	SUGG. RETAIL
C ▶ 30787020	Mossy Oak Break-Up Infinity					S-XL \$47.00
30787018	Mossy Oak Treestand					S-XL 47.00



A ▶ Pant Break-Up® Infinity™



B ▶ Insulated Bib Treestand®



C ▶ Glove Break-Up® Infinity™



**XPO™**  
XTENDED PERFORMANCE OUTERWEAR

**XPO — EXCEPTIONAL COMFORT AND PERFORMANCE.**

Browning XPO (eXtended Performance Outerwear) is designed to be affordable, tough, comfortable and functional in all types of weather conditions. XPO features Pre-Vent®, a waterproof, windproof, breathable laminate that ensures protection from the most severe conditions you are likely to encounter in the field, yet remains breathable to let perspiration escape. Importantly, Pre-Vent does all this at a very competitive price, without skimping on other features that matter like abundant pockets, quality zippers and rugged construction.





**NEW**

**NEW**



**D** ▶ For Her Jacket  
Break-Up® Infinity™



**XPO FOR HER AND XPO JUNIOR – BIG GAME OUTDOOR WEAR FOR YOUR WHOLE FAMILY.**

A cold and wet experience can make or break a day hunting, even for your hunting partners. Fortunately, every member of your family can enjoy the same protection with XPO For Her and XPO Junior outerwear. XPO For Her and XPO Junior maximize comfort, warmth and mobility without the performance downgrades common in the other makers' hunting clothes. Make the outdoors more comfortable and more fun for everyone with XPO For Her and XPO Junior.

**E** ▶ For Her Bib  
Break-Up® Infinity™



**XPO FOR HER BIG GAME JACKET**



Pre-Vent® waterproof, breathable shell fabric · Specifically cut and designed for women · Insulated for warmth without bulk · Adjustable hood · Differential cut · Front wind flap · Two zippered bellows pockets plus inside security pocket · Adjustable Lycra® cuffs · Drawcord waist · Quiet, direct-attach zipper pulls · Sizes: S-XL

NUMBER	DESCRIPTION	S	M	L	XL	SUGG. RETAIL
<b>D</b> ▶ 30460720	<b>NEW</b> Mossy Oak Break-Up Infinity				S-XL	\$151.00

**XPO FOR HER BIG GAME BIB**



Pre-Vent® waterproof, breathable shell fabric · Specifically cut and designed for women · Insulated for warmth without bulk · Two handwarmer pockets · Knit side gussets · Full-length front zipper · Full-length leg zippers · Zippered rear pocket · Sizes: S-XL

NUMBER	DESCRIPTION	S	M	L	XL	SUGG. RETAIL
<b>E</b> ▶ 30660820	<b>NEW</b> Mossy Oak Break-Up Infinity				S-XL	\$117.00

**XPO JUNIOR BIG GAME PARKA**



Pre-Vent® waterproof, breathable shell fabric · Cut specifically for junior builds · Insulated for superior warmth · Adjustable hood · Differential cut is longer in the back to prevent drafts when sitting · Front wind flap · Two zippered bellows pockets plus inside security pocket · Adjustable cuffs · Quiet, direct-attach zipper pulls · Sizes: S (6-8), M (10-12), L (14-16), XL (18-20)

NUMBER	DESCRIPTION	S	M	L	XL	SUGG. RETAIL
<b>F</b> ▶ 30367320	Mossy Oak Break-Up Infinity				S-XL	\$116.00

**XPO JUNIOR BIG GAME BIB**



Pre-Vent® waterproof, breathable shell fabric · Cut specifically for junior builds · Insulated for superior warmth · Two handwarmer pockets · Knit side gussets · Full-length front zipper · Knee-length leg zippers · Rear pocket · Sizes: S (6-8), M (10-12), L (14-16), XL (18-20)

NUMBER	DESCRIPTION	S	M	L	XL	SUGG. RETAIL
<b>G</b> ▶ 30667420	Mossy Oak Break-Up Infinity				S-XL	\$99.00

**G** ▶ Junior Bib  
Break-Up® Infinity™



**F** ▶ Junior Parka  
Break-Up® Infinity™





**HELL'S CANYON — AS TOUGH AS YOU ARE.**

Tough as nails, Browning Hell's Canyon is a top-seller because it offers tremendous value and performance. The rugged 3-layer fabric is water- and wind-resistant. The moisture-wicking OdorSmart™ fleece on the inside keeps you warm and helps control human odor. Go the distance in Hell's Canyon.



A ► Jacket Break-Up® Infinity™



**HELL'S CANYON FULL THROTTLE JACKET**

Rugged 3-layer fabric is silent in brush, windproof, breathable and highly water-resistant  
 · OdorSmart™ anti-microbial, moisture wicking fleece lining · Full-length front zipper with internal storm flap · Zippered handwarmer pockets · Zippered ventilator chest pockets · Bottom drawcord  
 · Adjustable neoprene cuffs · Sizes: S-3XL

NUMBER	DESCRIPTION	S	M	L	XL	2XL	3XL	SUGG. RETAIL
A ► 30481420	Mossy Oak Break-Up Infinity							\$117.00
								129.00
30481418	Mossy Oak Treestand							117.00
								129.00
30481401	Blaze							105.00
								116.00

**HELL'S CANYON VEST**

Rugged 3-layer fabric is silent in brush, windproof, breathable and highly water-resistant  
 · OdorSmart™ anti-microbial, moisture wicking fleece lining · Full-length front zipper with internal storm flap · Zippered cargo pockets and ventilator pockets with storm flaps · Bottom drawcord  
 · Sizes: S-3XL

NUMBER	DESCRIPTION	S	M	L	XL	2XL	3XL	SUGG. RETAIL
30581420	Mossy Oak Break-Up Infinity							\$93.00
								105.00
30581418	Mossy Oak Treestand							93.00
								105.00
B ► 30581401	Blaze							82.00
								93.00

B ► Vest Blaze



**HELL'S CANYON PANT**

Rugged 3-layer fabric is silent in brush, windproof, breathable and highly water-resistant  
 · OdorSmart™ anti-microbial, moisture wicking fleece lining · Differential cut waistband is higher in the back to prevent drafts when sitting · Grip strip waistband with suspender buttons  
 · Belt loops · Zippered fly · Two front pockets, two zippered cargo pockets and one rear pocket  
 · Neoprene cuffs · Sizes: S-3XL

NUMBER	DESCRIPTION	S	M	L	XL	2XL	3XL	SUGG. RETAIL
C ► 30281520	Mossy Oak Break-Up Infinity							\$129.00
								140.00
30281518	Mossy Oak Treestand							129.00
								140.00
30281501	Blaze							116.00
								129.00

**HELL'S CANYON GLOVES**

Shell fabric matches Hell's Canyon clothing · No-slip palm and thumb patch · Pre-curved fingers with knit trigger finger · Elasticized wrist · Moisture moving lining · Warm fleece lining · Sizes: S-XL

NUMBER	DESCRIPTION	S	M	L	XL	SUGG. RETAIL
D ► 30788820	Mossy Oak Break-Up Infinity					\$35.00
30788818	Mossy Oak Treestand					35.00



D ► Gloves Break-Up® Infinity™



**HELL'S CANYON BEANIE**

Four-way stretch fabric assures comfortable fit · Warm, comfortable lining · Easily stuffs away into pocket or pack · Sizes: One size fits most

NUMBER	DESCRIPTION	ONE SIZE FITS MOST	SUGG. RETAIL
E ► 30894120	Mossy Oak Break-Up Infinity	one size	\$29.00
30894114	Mossy Oak Break-Up (Limited quantity)	one size	29.00



E ► Beanie Break-Up® Infinity™





F ▶ Full Throttle Jacket  
Break-Up® Infinity™



G ▶ Full Throttle Pant  
Break-Up® Infinity™



HELL'S CANYON FULL THROTTLE — GO TOP SPEED.

Lighter weight Hell's Canyon Full Throttle gear brings a level of performance to your hunt with a 2-layer fabric featuring a rugged water- and wind-resistant woven outer shell bonded to moisture-wicking OdorSmart™ featherweight fleece on the inside. Because there is no lamination layer, there is less resistance to airflow through the fabric for increased breathability. You will stay dry and comfortable in warmer weather and higher activity levels as perspiration is quickly moved away from your body. Crank up the intensity of your next hunt with Hell's Canyon Full Throttle.



HELL'S CANYON FULL THROTTLE JACKET

Woven 2-layer bonded fabric is highly water- and wind-resistant and extremely breathable  
 · Lightweight moisture wicking fleece lining with OdorSmart™ anti-microbial technology  
 · Differential cut (longer in the back) · Stand-up, zip-through collar with double-pull closure  
 · On-seam handwarmer pockets · Extra large zippered chest pockets · Bottom drawcord  
 · Sizes: S-3XL

NUMBER	DESCRIPTION	S	M	L	XL	2XL	3XL	SUGG. RETAIL
F ▶ 30497720	Mossy Oak Break-Up Infinity						S-XL 2XL-3XL	\$105.00 117.00
30497718	Mossy Oak Treestand						S-XL 2XL-3XL	105.00 117.00

HELL'S CANYON FULL THROTTLE PANT

Woven 2-layer fabric is highly water- and wind-resistant and extremely breathable  
 · Lightweight moisture wicking fleece lining with OdorSmart™ anti-microbial technology  
 · Zip-to-knee cuff openings · Elasticized waist with drawcord and belt loops · Zippered fly  
 · Two front pockets, one zippered rear security pocket · Articulated knee for extra mobility  
 · Sizes: S-3XL

NUMBER	DESCRIPTION	S	M	L	XL	2XL	3XL	SUGG. RETAIL
G ▶ 30297720	Mossy Oak Break-Up Infinity						S-XL 2XL-3XL	\$105.00 117.00
30297718	Mossy Oak Treestand						S-XL 2XL-3XL	105.00 117.00





**XPO™**  
XTENDED PERFORMANCE OUTERWEAR



**GEAR 'TRIEVER™**

C ▶ Gear 'Trievers® (calls not included)

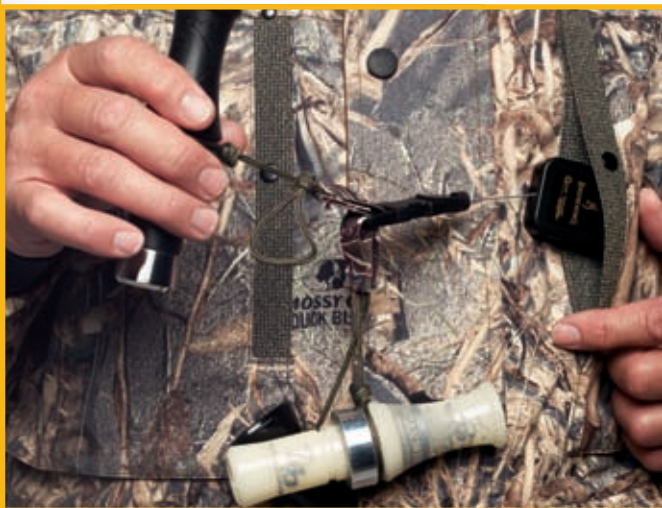

### XPO GRAND PASSAGE 4-IN-1 PARKA

**Shell:** Pre-Vent® waterproof, breathable shell fabric · Mesh moisture barrier strip between shell and lining · Set-in sleeves with one-piece, no-seam construction · Articulated elbow for ease of movement · Detachable, insulated, height-adjustable hood · Two oversize, spill-proof bellows pockets with magnetic closures and handwarmer pockets · Shell pockets with the Pocket Expander System · Two Gear 'Trievers™ System pockets · Two chest handwarmer pockets · Inside security pocket · Two-way front zipper with internal and external storm flaps · Adjustable, watertight neoprene cuffs with hook and loop closure · Molded shoulder strips protect fabric wear from heavy bags · Internal waist drawcord · X-Change System compatible  
**Liner:** Camo fleece reverses to solid-color woven fabric · SelectWeight™ insulation system maximizes warmth and freedom of movement · Set-in sleeves · Elasticized bottom and knit cuffs · Two slash pockets on each side · X-Change System compatible · Sizes: S-3XL

NUMBER	DESCRIPTION	S	M	L	XL	2XL	3XL	SUGG. RETAIL
A ▶ 30398217	Mossy Oak Duck Blind						S-XL 2XL-3XL	\$280.00 303.00

### XPO GRAND PASSAGE PRIMALOFT® GLOVES

Shell fabric matches XPO Grand Passage clothing · 100% waterproof, windproof and breathable · No-slip palm · Fully insulated with PrimaLoft® · Elasticized wrist · Moisture moving lining · Sizes: S-XL

NUMBER	DESCRIPTION	S	M	L	XL	SUGG. RETAIL
B ▶ 30786917	Mossy Oak Duck Blind					S-XL \$47.00

### GEAR 'TRIEVER

No more hanging or dropping calls and accessories · Attaches to jackets, webbing, belts or straps · Retractable cable keeps calls and gear at hand and out of the elements · Call Lanyard model holds up to four calls · Accessory model with a split-ring is ideal for e-collar and decoy remotes, flashlights, etc. · Fits in the chest pockets of some Browning jackets and parkas

NUMBER	DESCRIPTION	SUGG. RETAIL
C ▶ 121011	Gear 'Trievers Duck Call Lanyard	\$38.00
121012	Gear 'Trievers Accessory with Split Ring	27.00
121013	Gear 'Trievers Lanyard Only	15.00





D ▶ Insulated Jacket  
Duck Blind®



E ▶ Insulated Bib  
Duck Blind®



F ▶ Layout Bib  
Duck Blind®

### XPO GRAND PASSAGE INSULATED JACKET

Pre-Vent® waterproof, breathable shell fabric · SelectWeight™ insulation system maximizes warmth and freedom of movement · Mesh moisture barrier strip between shell and lining · Soft and warm brushed tricot lining, reversed in sleeves · Set-in sleeves with one-piece, no-seam construction · Articulated elbow for ease of movement · Detachable, insulated, height-adjustable hood · Two oversize, spill-proof bellows pockets with magnetic closures and handwarmer pockets · Shell pockets with the Pocket Expander System · Two Gear “Trievers” System pockets · Two chest handwarmer pockets · Inside security pocket · Two-way front zipper with internal and external storm flaps · Adjustable, watertight neoprene cuffs with hook and loop closure · Molded shoulder strips protect fabric wear from heavy bags · Internal waist drawcord · Removable neoprene skirt helps seal out water · Short length is ideal for wading · Sizes: S-3XL

NUMBER	DESCRIPTION	S	M	L	XL	2XL	3XL	SUGG. RETAIL
D ▶ 30498417	Mossy Oak Duck Blind							S-XL \$210.00 2XL-3XL 221.00

### XPO GRAND PASSAGE INSULATED BIB

Pre-Vent® waterproof, breathable shell fabric · Brushed tricot lining · Thermore® insulation · Full-length, two-way side seam zippers with storm flaps · Rib knit side vent gussets · Elasticized suspenders with cam lock buckles · One zippered rear pocket · Two-way zippered front opening storm flap · Sizes: S-3XL

NUMBER	DESCRIPTION	S	M	L	XL	2XL	3XL	SUGG. RETAIL
E ▶ 30698617	Mossy Oak Duck Blind							S-XL \$164.00 2XL-3XL 175.00

### XPO GRAND PASSAGE LAYOUT BIB

Pre-Vent® waterproof, breathable shell fabric · Brushed tricot lining · Non-insulated construction for year around comfort · Double-padded torso area for comfort and warmth while on the ground · Full-length, two-way side seam zippers with storm flaps · Rib knit side vent gussets · Elasticized suspenders with cam lock buckles · Kangaroo-style bellows chest pocket with pass-through handwarmer pocket · Sizes: S-3XL

NUMBER	DESCRIPTION	S	M	L	XL	2XL	3XL	SUGG. RETAIL
F ▶ 30697417	Mossy Oak Duck Blind							S-XL \$151.00 2XL-3XL 164.00

### XPO GRAND PASSAGE LAYOUT BIB

The specialized Grand Passage Layout Bib has features specifically designed to maximize your comfort in the layout blind. The bib is highlighted by a waterproof, breathable Pre-Vent® laminate and is uninsulated, yet easily layered, for multi-season versatility. The back of the bib is double-padded to increase comfort and protection from the ice-cold ground. An oversize bellows pocket on the chest keeps oft needed gear at the ready and a pass-through handwarmer pocket keeps your hands warm and dry.



**WING-SET JACKET—  
RUGGED PERFORMANCE FOR RUGGED CONDITIONS.**

Weighing a mere 26 oz., the rugged soft shell Wing-Set jacket provides heavyweight protection from gouging sticks, thorns and the paws of an excited retriever. The rugged 3-layer fabric combines a rugged nylon outer shell, waterproof, windproof and breathable Pre-Vent® lamination plus a soft inner fleece layer to provide warmth and protection over a wide range of conditions. Unlike other soft shell jackets that only claim to be waterproof, the Wing-Set jacket truly is, with external taping on every seam. Freedom sleeve construction and articulated elbows allow you unrestricted movement to swing and follow through on fast flying birds. Discover how comfortable hunting can be with the lightweight, minimal bulk and mega protection of the Wing-Set jacket.



FREEDOM SHOULDER  
AND ARTICULATED  
ELBOW DESIGN

CALL POCKETS  
ON CHEST

DETACHABLE,  
ADJUSTABLE HOOD

EXTERNALLY TAPED  
SEAMS FOR 100%  
WATERPROOF  
PERFORMANCE

A ► Jacket  
Duck Blind®

ADJUSTABLE DRAWCORD  
BOTTOM

ADJUSTABLE  
WATER-RESISTANT  
CUFFS



**WING-SET JACKET**

Lightweight soft shell 3-layer fabric features Browning Pre-Vent® waterproof, windproof and breathable laminate · Fully-taped seams · Water-resistant laminated cuffs with hook and loop closures · Freedom shoulder design and articulated elbow for unrestricted movement · Two upper call pockets with zipper closures · Two lower pockets with zipper closures · Detachable hood with drawcord adjustment · Full-length front zipper with inner and outer storm flaps · Drawcord bottom adjusts from inside lower pockets · Sizes: S-3XL

NUMBER	DESCRIPTION	S	M	L	XL	2XL	3XL	SUGG. RETAIL
A ► 30479417	Mossy Oak Duck Blind							S-XL \$222.00 2XL-3XL 245.00



**WINDKILL & WARM FRONT — VERSATILE PROTECTION.**

Chilly mornings often become sunny and warm afternoons that require a versatile mid-layer. WindKill outerwear features a fleece lining and a highly wind- and water-resistant outer shell, making it perfect as an insulation layer on cold days or an outer layer on blustery days. Lightweight Warm Front layers are ideal in drier, cooler weather. These protective shells are easily worn over additional layers to fend off the wind and light rain or snow.



**B** ▶ Pullover Duck Blind®



**C** ▶ Vest Duck Blind®



**D** ▶ Half-Zip Pullover Duck Blind®



**E** ▶ Shirt Duck Blind®

**WINDKILL WATERFOWL PULLOVER**

Waterfowl soft shell 3-layer, 4-way stretch laminated fabric with an abrasion-resistant and highly water-resistant polyester outer face, middle layer is a WindKill™ laminate that blocks wind and provides water resistance in all but the most extreme weather, inner layer is a soft fleece · Two chest pockets: one zippered, one magnetic closure · Upper handwarmer pockets are positioned above the wader line · Side panel construction features breathable tricot for a comfortable fit inside waders · Half-length zipper · Stand-up collar · Sizes: S-3XL

NUMBER	DESCRIPTION	S	M	L	XL	2XL	3XL	SUGG. RETAIL
<b>B</b> ▶ 30522517	Mossy Oak Duck Blind						S-XL 2XL-3XL	\$111.00 123.00

**WINDKILL WATERFOWL VEST**

Waterfowl soft shell 3-layer, 4-way stretch laminated fabric with an abrasion-resistant and highly water-resistant polyester outer face, middle layer is a WindKill™ laminate that blocks wind and provides water resistance in all but the most extreme weather, inner layer is a soft fleece · Two chest pockets: one zippered, one magnetic closure · Upper handwarmer pockets are positioned above wader line · Side panel construction features breathable tricot for a comfortable fit inside waders · Full-length zipper · Stand-up collar · Sizes: S-3XL

NUMBER	DESCRIPTION	S	M	L	XL	2XL	3XL	SUGG. RETAIL
<b>C</b> ▶ 30522517	Mossy Oak Duck Blind						S-XL 2XL-3XL	\$85.00 99.00

**WARM FRONT HALF-ZIP PULLOVER**

Highly breathable, Leeward wind-resistant barrier is a 100% poly microtwill fabric offering lightweight protection for warm, clear weather · Stand-up, zip-through fleece-lined collar · Button down collar · Longer sleeve plackets for easy sleeve roll-up · Small front pocket · Lanyard tab keeps calls out of the way · Warm fleece lining · Sizes: S-3XL

NUMBER	DESCRIPTION	S	M	L	XL	2XL	3XL	SUGG. RETAIL
<b>D</b> ▶ 30012617	Mossy Oak Duck Blind						S-3XL	\$61.00

**WARM FRONT SHIRT**

Highly breathable, water-resistant polyester fabric offers lightweight protection for warm, clear weather · Lightweight tricot lining adds warmth without bulk for comfort under waders · Button down collar · Longer sleeve plackets for easy sleeve roll-up · Two chest pockets: one zippered, one magnetic closure · Two upper handwarmer pockets are positioned above the wader line · Sizes: S-3XL

NUMBER	DESCRIPTION	S	M	L	XL	2XL	3XL	SUGG. RETAIL
<b>E</b> ▶ 30118717	Mossy Oak Duck Blind						S-XL 2XL-3XL	\$86.00 98.00





### 4X MICROFLEECE — THE RIGHT FLEECE.

4X Microfleece has four times the wind resistance of regular fleece. It is ideal for nearly all hunting situations. Under fair skies, in warmer temperatures, 4X adds just the right amount of insulation and wind protection. When layered underneath a waterproof parka, it offers excellent insulating performance with little bulk.



A ► Jacket  
Break-Up®  
Infinity™



C ► Gloves  
Break-Up®  
Infinity™

B ► Pant  
Break-Up®  
Infinity™

## MICRO FLEECE™



### 4X MICROFLEECE JACKET

Highly constructed microfiber fleece is wind-resistant and extremely quiet · Backpack friendly design eliminates bulk and weight and provides easy access to pockets · Duplex handwarmer pockets feature upper and lower section separated by internal zipper · Set-in sleeves are fully lined for easy on / off and feature Lycra® cuff opening · Two zippered handwarmer pockets and internal zippered security pocket · Contrasting side stripe · Sizes: S-3XL

NUMBER	DESCRIPTION	S	M	L	XL	2XL	3XL	SUGG. RETAIL
A ► 30479020	Mossy Oak Break-Up Infinity						S-XL	\$105.00
							2XL-3XL	116.00
30479017	Mossy Oak Duck Blind						S-XL	105.00
							2XL-3XL	116.00

### 4X MICROFLEECE PANT

Highly constructed microfiber fleece is wind-resistant and extremely quiet · Elasticized drawcord waist · Belt loops · Knee-length zippers · One rear zippered pocket · Zippered fly · Sizes: S-3XL

NUMBER	DESCRIPTION	S	M	L	XL	2XL	3XL	SUGG. RETAIL
B ► 30279220	Mossy Oak Break-Up Infinity						S-XL	\$82.00
							2XL-3XL	93.00

### 4X MICROFLEECE GLOVES

Highly constructed microfiber fleece is wind-resistant and extremely quiet · Form-fitting design with textured palm and thumb overlay · Sizes: S-XL

NUMBER	DESCRIPTION	S	M	L	XL	SUGG. RETAIL
C ► 30785620	Mossy Oak Break-Up Infinity					S-XL \$29.00



**NEW**



D ▶ Jacket  
Break-Up® Infinity™

**NEW**



E ▶ Pant  
Break-Up® Infinity™



**NEW**



F ▶ Junior Jacket  
Break-Up® Infinity™

### TF-300 FLEECE. WARM AND SOFT.

TF-300 is a perennial favorite in the Browning line. It is soft, warm, quiet, breathable and affordable. TF-300 makes an ideal layering piece underneath a waterproof shell. As stand-alone garments, they make you all but silent when stalking game. For 2011, Browning Junior is ready to provide warm, comfortable protection for little hunting partners.

#### TF-300 FLEECE JACKET

Midweight fleece with durable, water-repellent finish · Full-length front zipper closure · Elasticized cuffs and bottom · Stand-up, zip-through collar · Nylon reinforced collar · Two on-seam handwarmer pockets · X-Change System compatible · Sizes: S-3XL

NUMBER	DESCRIPTION	S	M	L	XL	2XL	3XL	SUGG. RETAIL
D ▶ 30473020	<b>NEW</b> Mossy Oak Break-Up Infinity						S-XL 2XL-3XL	\$82.00 88.00

#### TF-300 FLEECE PANT

Midweight fleece with durable, water-repellent finish · Adjustable elasticized waist · Knit cuffs with side seam leg zippers · Two on-seam pockets · Zippered rear pocket · Sizes: S-3XL

NUMBER	DESCRIPTION	S	M	L	XL	2XL	3XL	SUGG. RETAIL
E ▶ 30273220	<b>NEW</b> Mossy Oak Break-Up Infinity						S-XL 2XL-3XL	\$70.00 76.00

#### JUNIOR TF-300 FLEECE JACKET

Midweight fleece with durable, water-repellent finish · Full-length front zipper closure · Elasticized cuffs and bottom · Stand-up, zip-through collar · Nylon reinforced collar · Two on-seam handwarmer pockets · X-Change System compatible · Sizes: S-XL

NUMBER	DESCRIPTION	S	M	L	XL	SUGG. RETAIL
F ▶ 30466220	<b>NEW</b> Mossy Oak Break-Up Infinity					S-XL \$70.00





A ▶ Jacket  
Tan



B ▶ Jacket  
Forest



C ▶ Jacket  
Duck Blind®

### SANTA FE DOWN — HEAVY DUTY WARMTH.

Santa Fe down jackets are designed to withstand the use and abuse that might destroy a lesser down garment. The heavy-duty, highly-constructed Repel-Tex™ fabric is treated with a revolutionary new wax finish that sheds water and makes Santa Fe jackets extremely water-resistant. This new treatment adheres to the jacket significantly better than traditional waxing and remains unchanged over time and multiple washings. Santa Fe jackets are also cut longer to give you additional protection from the cold. Knit cuffs seal out drafts. Check out the next generation of down with new Santa Fe jackets.

#### SANTA FE DOWN JACKET

Water- and wind-resistant Repel-Tex™ shell fabric · 650 fill-power goose down insulation · Downproof nylon lining · Full-length front zipper flap · Fleece-lined, down-filled zip-through collar · Drawcord adjustable bottom · Two lower slash pockets and single inside pocket with zippered closure · Knit cuffs · Sizes: S-3XL

NUMBER	DESCRIPTION	S	M	L	XL	2XL	3XL	SUGG. RETAIL
A ▶ 30479332	Tan							S-XL \$182.00
								2XL-3XL 200.00
B ▶ 30479341	Forest							S-XL 182.00
								2XL-3XL 200.00
C ▶ 30479317	Mossy Oak Duck Blind							S-XL 194.00
								2XL-3XL 206.00





**THE STAPLE FOR EVERY HUNTER — 650 DOWN.**

Down is the ultimate insulator. It is light, compact and extremely warm. For these reasons you should have down as a staple in your gear collection, and you need look no further than Browning. Our 650 Down jackets and vests make ideal layering garments in frigid, conditions and are excellent as a stand-alone piece as well. Their stylish look also makes them suitable to wear around town when the temperatures drop.



**D ▶ Jacket**  
Break-Up® Infinity™



**E ▶ Jacket**  
Duck Blind®

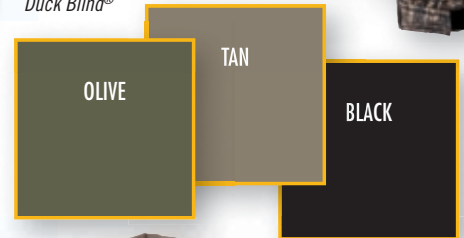

**650 DOWN JACKET**

Downproof microfiber shell · 650 fill-power goose down insulation · Taffeta lining · Full-length front zipper closure · Stand-up, zip-through collar · Drawcord adjustable bottom · Elasticized cuffs with hook and loop closure · Two lower slash pockets and single inside pocket with zippered closure · Stuffs into included bag · X-Change System compatible · Sizes: S-3XL

NUMBER	DESCRIPTION	S	M	L	XL	2XL	3XL	SUGG. RETAIL
<b>D ▶</b> 30475320	Mossy Oak Break-Up Infinity						S-XL	\$133.00
							2XL-3XL	145.00
<b>E ▶</b> 30475317	Mossy Oak Duck Blind						S-XL	133.00
							2XL-3XL	145.00
30475342	Olive						S-XL	121.00
30475332	Tan						S-XL	121.00
							2XL-3XL	133.00
30475390	Black						S-XL	121.00
							2XL-3XL	133.00

**650 DOWN VEST**

Downproof microfiber shell · 650 fill-power goose down insulation · Taffeta lining · Full-length front zipper closure · Stand-up, zip-through collar · Drawcord adjustable bottom · Two lower slash pockets and single inside pocket with zippered closure · Stuffs into included bag · X-Change System compatible · Sizes: S-3XL

NUMBER	DESCRIPTION	S	M	L	XL	2XL	3XL	SUGG. RETAIL
30575420	Mossy Oak Break-Up Infinity						S-XL	\$103.00
							2XL-3XL	109.00
30575417	Mossy Oak Duck Blind						S-XL	103.00
							2XL-3XL	109.00
30575442	Olive						S-XL	90.00
							2XL-3XL	103.00
<b>F ▶</b> 30575432	Tan						S-XL	90.00
							2XL-3XL	103.00
30575490	Black						S-XL	90.00
							2XL-3XL	103.00



**F ▶ Vest**  
Tan



**FULL CURL WOOL — THE EVOLUTION OF NATURE'S MOST FUNCTIONAL FABRIC.**

First there was wool, supremely versatile yet itchy. Then came non-itch wool blends that were just as versatile but more comfortable to wear. Now, we have taken wool to an even higher level with Full Curl Wool, and this wonder fabric has never been more comfortable and effective against the elements. Full Curl combines a durable 7 oz. wool blend outer fabric a new WindKill™ windproof and water-resistant lamination and soft tricot lining for the ultimate wool fabrication. Fleece side panels are added to increase breathability. The 3-in-1 Parka relies upon another of nature's wonders — goose down — to provide insulation in the removable liner. The rugged, time-honored performance of wool makes the new Full Curl ideal for nearly all conditions, terrains and activity levels.



A ▶ Parka AllTerrain

DETACHABLE HOOD

REMOVABLE DOWN VEST LINER

ZIPPERED SLASH POCKETS

WINDKILL LAMINATE

BELLOWS POCKETS

FLEECE SIDES

**NEW**



**FULL CURL WOOL 3-IN-1 PARKA**

7 oz. wool blend · WindKill™ laminate blocks wind and provides water resistance in all but the most extreme weather · Removable down vest · Soft tricot lining · Breathable fleece side panels · Washable · Two upper zippered slash pockets · Two lower bellows pockets with snap closures · Two handwarmer pockets · Zip-off hood · Zip-through collar · Longer parka length · Adjustable cuffs · External storm flap · Browning AllTerrain camouflage pattern · Sizes: S-2XL

NUMBER	DESCRIPTION	S	M	L	XL	2XL	SUGG. RETAIL
A ▶ 30319829	AllTerrain					S-2XL	\$254.50

**FULL CURL WOOL BIB**

7 oz. wool blend · WindKill™ laminate blocks wind and provides water resistance in all but the most extreme weather · Soft tricot lining · Washable · Zip-to-knee cuff openings with storm flaps · Elasticized suspenders with cam lock buckles · One front zippered pocket · Zippered front opening with two-way zipper and storm flap · Browning AllTerrain camouflage pattern · Sizes: S-2XL

NUMBER	DESCRIPTION	S	M	L	XL	2XL	SUGG. RETAIL
B ▶ 30619829	<b>NEW</b> AllTerrain					S-2XL	\$221.50

B ▶ Bib AllTerrain





C Jacket AllTerrain



D Pant AllTerrain



**FULL CURL WOOL JACKET**

7 oz. wool blend · WindKill™ laminate blocks wind and provides water resistance in all but the most extreme weather · Soft tricot lining · Breathable fleece side panels · Washable · Two upper zippered slash pockets · Two handwarmer pockets · Zip-through collar · Adjustable cuffs · Browning AllTerrain camouflage pattern · Sizes: S-2XL

NUMBER	DESCRIPTION	S	M	L	XL	2XL	SUGG. RETAIL
C ▶ 30419829	AllTerrain					S-2XL	\$150.50

**FULL CURL WOOL PANT**

7 oz. wool blend · WindKill™ laminate blocks wind and provides water resistance in all but the most extreme weather · Soft tricot liner · Washable · Six pocket design · Drawstring cuffs · Button closures on rear and cargo pockets · Browning AllTerrain camouflage pattern · Sizes: S-2XL

NUMBER	DESCRIPTION	S	M	L	XL	2XL	SUGG. RETAIL
D ▶ 30219829	AllTerrain					S-2XL	\$150.50



**FULL CURL WOOL — AND FOR HER.**

Itch-free Full Curl Wool base layers are the foundation for warmth on the coldest days. Full Curl Wool For Her offers the same features as the men's versions, with a cut tailored to fit the ladies.



A ► Top Mock Neck Loden



B ► Top, Quarter-Zip Loden



C ► Bottom Loden

**FULL CURL WOOL BASE LAYER TOP**

Comfortable, no-itch Merino wool blend construction · Breathable polyester side panels · Odor reduction from natural anti-microbial properties of wool · Self fabric neck and cuffs · Mock neck or quarter-zip models available · Sizes: S-2XL

NUMBER	DESCRIPTION	S	M	L	XL	2XL	SUGG. RETAIL
A ► 30119929	Mock Neck Loden					S-2XL	\$50.50
B ► 30119129	NEW Quarter-Zip Loden					S-2XL	58.00

**FULL CURL WOOL BASE LAYER BOTTOM**

Comfortable, no-itch Merino wool blend construction · Odor reduction from natural anti-microbial properties of wool · Self fabric cuffs · Elastic waistband · Fly opening · Sizes: S-2XL

NUMBER	DESCRIPTION	S	M	L	XL	2XL	SUGG. RETAIL
C ► 30219929	Loden					S-2XL	\$50.50

**FULL CURL WOOL PARKA FOR HER**

7 oz. wool blend · WindKill™ laminate blocks wind and provides water resistance in all but the most extreme weather · Soft tricot lining · Breathable fleece side panels · Washable · Two upper pockets · Two lower bellows pockets with snap closures · Two handwarmer pockets · Zip-off hood · Zip-through collar · Longer parka length · Adjustable cuffs · External storm flap · Browning AllTerrain camouflage pattern · Specially cut for ladies · Pink Buckmark embroidery · Sizes: S-2XL

NUMBER	DESCRIPTION	S	M	L	XL	2XL	SUGG. RETAIL
D ► 30318829	NEW AllTerrain					S-2XL	\$140.00

**FULL CURL WOOL PANT FOR HER**

7 oz. wool blend · WindKill™ laminate blocks wind and provides water resistance in all but the most extreme weather · Soft tricot lining · Washable · Six pocket design · Drawstring cuffs · Button closures on rear and cargo pockets · Side tab waist adjustment · Browning AllTerrain camouflage pattern · Specially cut for ladies · Pink Buckmark embroidery · Sizes: S-2XL

NUMBER	DESCRIPTION	S	M	L	XL	2XL	SUGG. RETAIL
E ► 30218829	NEW AllTerrain					S-2XL	\$116.50





**FULL CURL WOOL SWEATER — PERFECT FOR NEARLY ALL CONDITIONS.**

Simple and versatile, a wool sweater is a must for every serious hunter. It is a warm and insulating layer, even if it gets wet. It is also breathable. Now, with the addition of windproof WindKill™, the Full Curl Wool Sweater becomes a great choice as an outer piece. Unlike wool sweaters of yesteryear, the Full Curl Sweater with WindKill features an itch-free lining to keep you comfortable.



**NEW**

F ▶ Sweater AllTerrain



**FULL CURL WOOL SWEATER**

Wool/acrylic blend knit fabric · Available with soft poly tricot lining with WindKill™ windproof lamination · One-piece knit construction · Faux suede collar and pocket trims · Four-button front · Handwarmer pockets · Also available without WindKill · Sizes: S-2XL

NUMBER	DESCRIPTION	S	M	L	XL	2XL	SUGG. RETAIL
F ▶ 30020229	<b>NEW</b> AllTerrain					S-2XL	\$81.50
30020329	<b>NEW</b> AllTerrain with WindKill					S-2XL	93.00

**FULL CURL WOOL BEANIE**

Wool/acrylic blend knit fabric · Soft poly tricot lining with WindKill™ windproof lamination · One-piece knit construction · Stretch fit · Sizes: One size fits most

NUMBER	DESCRIPTION	ONE SIZE FITS MOST	SUGG. RETAIL
G ▶ 30827829	<b>NEW</b> AllTerrain	one size	\$23.00



**NEW**

G ▶ Beanie AllTerrain



**HIGHLANDS II — THE BEST GETS BETTER.**

The insulating advantages of wool in cold, wet weather are well known. For time-proven performance combined with today's technology, look to Browning's Highlands II wool. Highlands II offers additional versatility by taking a wool blend and adding a soft tricot lining for extra warmth and comfort, without the itch usually associated with wool. These versatile products are also machine washable. 11 oz. wool blend makes up the parka and bib, offering the same rugged performance in cold weather. The shirt and pant feature lighter weight 7 oz. wool blend to increase their versatility in warmer temperatures and as layering pieces. There is no substitute for the performance of Highlands II wool.



A ► Parka AllTerrain

B ► Bib AllTerrain

# HIGHLANDS II™

## HIGHLANDS II PARKA

Durable, quiet and breathable 11 oz. wool blend outer · Soft tricot lining · Washable · Two upper zippered slash pockets · Two lower bellows pockets with snap closures · Two handwarmer pockets · Zip-off hood · Zip-through collar · Longer parka length · Adjustable cuffs · External storm flap · Browning AllTerrain camouflage pattern · Sizes: S-2XL

NUMBER	DESCRIPTION	S	M	L	XL	2XL	SUGG. RETAIL
A ► 30328029	AllTerrain					S-2XL	\$181.50

## HIGHLANDS II BIB

Durable, quiet and breathable 11 oz. wool blend outer · Soft tricot lining · Washable · Zip-to-knee cuff openings with storm flaps · Elasticized suspenders with cam lock buckles · One front zippered pocket · Zippered front opening with two-way zipper and storm flap · Browning AllTerrain camouflage pattern · Sizes: S-2XL

NUMBER	DESCRIPTION	S	M	L	XL	2XL	SUGG. RETAIL
B ► 30628029	AllTerrain					S-2XL	\$191.00





D ▶ Pant  
AllTerrain

C ▶ Shirt  
AllTerrain



# HIGHLANDS II™

## HIGHLANDS II SHIRT

Durable, quiet and breathable 7 oz. wool blend · Tricot lining provides easy on/off · OdorSmart™ anti-microbial technology helps to control human odor · Moisture moving treatment wicks away perspiration · Washable · Generously cut, button-up design · Large chest pockets · Button-down collar · Browning AllTerrain camouflage pattern · Sizes: S-2XL

NUMBER	DESCRIPTION	S	M	L	XL	2XL	SUGG. RETAIL
C ▶ 30128029	AllTerrain					S-2XL	\$121.50

## HIGHLANDS II PANT

Durable, quiet and breathable 7 oz. wool blend · Tricot lining provides easy on/off · OdorSmart™ anti-microbial technology helps to control human odor · Moisture moving treatment wicks away perspiration · Washable · Six pocket design · Drawstring cuffs · Button closures on rear and cargo pockets · Browning AllTerrain camouflage pattern · Sizes: S-2XL

NUMBER	DESCRIPTION	S	M	L	XL	2XL	SUGG. RETAIL
D ▶ 30228029	AllTerrain					S-2XL	\$127.80



REACTAR



A ▶ Shirt Break-Up® Infinity™



B ▶ Shirt Duck Blind®



C ▶ Shirt Treestand®



D ▶ Shirt Bottomland®



E ▶ Pant Break-Up® Infinity™



F ▶ Pant Treestand®

## WASATCH — RUGGED COMFORT.

Wasatch Fieldwear is much more than just another line of camo clothing. Multiple pockets, a loose cut for freedom of movement and a durable cotton-rich fabric that breathes freely are notable additions that break Wasatch out of the crowd. Wasatch Fieldwear is a value-packed addition to your gear collection.

### WASATCH SHIRT

7 oz., 55% cotton, 45% polyester twill fabric · Seven-button front with long tails · Action back · REACTAR™ pad pocket behind right shoulder (pad sold separately) · Button-down collar · Double-needle side seam construction · Mossy Oak® camo patterns · Adjustable button cuffs and longer sleeve plackets for easier roll-up · Sizes: S-3XL

NUMBER	DESCRIPTION	S	M	L	XL	2XL	3XL	SUGG. RETAIL
A ▶	30113520 Mossy Oak Break-Up Infinity						S-XL 2XL-3XL	\$35.00 40.00
B ▶	30113517 Mossy Oak Duck Blind						S-XL 2XL-3XL	35.00 40.00
C ▶	30113518 Mossy Oak Treestand						S-XL 2XL-3XL	35.00 40.00
D ▶	30113519 Mossy Oak Bottomland						S-XL 2XL-3XL	35.00 40.00

### WASATCH PANT

7 oz., 55% cotton, 45% polyester twill · Deep front pockets · Oversized side cargo pockets with flap and button closure · Drawcord cuffs for snug fit around boots · Adjustable waist tabs for comfortable fit · Rear flap button-through pockets · Sizes: S-3XL, Inseam lengths: S-L 32½", XL-3XL 33½"

NUMBER	DESCRIPTION	S	M	L	XL	2XL	3XL	SUGG. RETAIL
E ▶	30213520 Mossy Oak Break-Up Infinity						S-XL 2XL-3XL	\$36.00 42.00
	30213517 Mossy Oak Duck Blind						S-XL 2XL-3XL	36.00 42.00
F ▶	30213518 Mossy Oak Treestand						S-XL 2XL-3XL	36.00 42.00
	30213519 Mossy Oak Bottomland						S-XL 2XL-3XL	36.00 42.00





**NEW**



H ▶ *OdorSmart™ Pant  
Break-Up® Infinity™*



**NEW**

**REACTAR**

G ▶ *OdorSmart™ Shirt  
Break-Up® Infinity™*



I ▶ *Chamois Shirt  
Break-Up® Infinity™*



J ▶ *Chamois Pant  
Break-Up® Infinity™*

**WASATCH ODORSMART SHIRT**

7 oz. 55% cotton, 45% polyester twill fabric · OdorSmart™ anti-microbial technology helps to control human odor · Seven-button front with long tails · Action back · Button-down collar · Double-needle side seam construction · Adjustable button cuffs and long sleeve plackets for easier roll-up · Sizes: S-3XL

NUMBER	DESCRIPTION	S	M	L	XL	2XL	3XL	SUGG. RETAIL
G ▶ 30115420	<b>NEW</b> Mossy Oak Break-Up Infinity						S-XL 2XL-3XL	\$46.50 52.50

**WASATCH ODORSMART PANT**

7 oz. 55% cotton, 45% polyester twill fabric · OdorSmart™ anti-microbial technology helps to control human odor · Deep front pockets · Oversized side cargo pockets with flap and button closure · Drawcord cuffs for snug fit around boots · Adjustable waist tabs for comfortable fit · Rear flap button-through pockets · Sizes: S-3XL, Inseam lengths: S-L 32½", XL-3XL 33½"

NUMBER	DESCRIPTION	S	M	L	XL	2XL	3XL	SUGG. RETAIL
H ▶ 30215420	<b>NEW</b> Mossy Oak Break-Up Infinity						S-XL 2XL-3XL	\$48.00 54.00

**WASATCH CHAMOIS SHIRT**

9 oz., 100% cotton chamois · Seven-button front with long tails · Action back · Button-down collar · Double-needle side seam construction · Adjustable button cuffs and longer sleeve plackets for easier roll-up · Sizes: S-3XL

NUMBER	DESCRIPTION	S	M	L	XL	2XL	3XL	SUGG. RETAIL
I ▶ 30113420	Mossy Oak Break-Up Infinity						S-XL 2XL-3XL	\$50.50 57.00
30113417	<b>NEW</b> Mossy Oak Duck Blind						S-XL 2XL-3XL	50.50 57.00

**WASATCH CHAMOIS PANT**

9 oz., 100% cotton chamois · Deep front pockets · Oversized side cargo pockets with flap and button closure · Drawcord cuffs for snug fit around boots · Adjustable waist tabs for comfortable fit · Rear flap button-through pockets · Sizes: S-3XL, Inseam lengths: S-L 32½", XL-3XL 33½"

NUMBER	DESCRIPTION	S	M	L	XL	2XL	3XL	SUGG. RETAIL
J ▶ 30213420	Mossy Oak Break-Up Infinity						S-XL 2XL-3XL	\$50.50 57.00
30213417	<b>NEW</b> Mossy Oak Duck Blind						S-XL 2XL-3XL	50.50 57.00





**WASATCH — RUGGED COMFORT FOR ALL.**

Wasatch Fieldwear is the most comfortable, best-built camo clothing available. For 2011, it's available for the whole family. Now ladies and young hunters alike can enjoy the same rugged, easy-wearing Wasatch Fieldwear as men, complete with all the conveniences that make Wasatch Fieldwear better than the rest.



**NEW**

A ▶ For Her Shirt Break-Up® Infinity™

B ▶ For Her Pant Break-Up® Infinity™



**WASATCH SHIRT FOR HER**



7 oz., 55% cotton 45% poly twill fabric · Button front design · Action back design · REACTAR™ Pad pocket · Open collar · Adjustable button cuffs and sleeves · Ladies cut · Pink trim fabric · Available in Mossy Oak Break Up Infinity · Sizes: S-XL

NUMBER	DESCRIPTION	S	M	L	XL	SUGG. RETAIL
A ▶ 30116420	<b>NEW</b> MOINF					S-XL \$34.40

**WASATCH PANT FOR HER**



7 oz., 55% cotton 45% poly twill fabric twill fabric · Deep front pockets · Oversized cargo pockets · Drawcord cuffs · Adjustable waist tab · Ladies cut · Pink trim fabric · Available in Mossy Oak Break Up Infinity · Sizes: S-XL

NUMBER	DESCRIPTION	S	M	L	XL	SUGG. RETAIL
B ▶ 30216420	<b>NEW</b> MOINF					S-XL \$36.30

**JUNIOR WASATCH SHIRT**



7 oz., 55% cotton 45% poly twill fabric · Button front design · Action back · Button down collar · Adjustable button cuffs and sleeves · Junior cut · Available in Mossy Oak Break Up Infinity · Sizes: S-XL

NUMBER	DESCRIPTION	S	M	L	XL	SUGG. RETAIL
C ▶ 30119020	<b>NEW</b> MOINF					S-XL \$31.50

**JUNIOR WASATCH PANT**



7 oz., 55% cotton 45% poly twill fabric · Deep front pockets · Oversized cargo pockets · Drawcord cuffs · Adjustable waist tab · Junior cut · Mossy Oak Break Up Infinity · Sizes: S-XL

NUMBER	DESCRIPTION	S	M	L	XL	SUGG. RETAIL
D ▶ 30219020	<b>NEW</b> MOINF					S-XL \$31.50

**NEW**



C ▶ Junior Shirt Break-Up® Infinity™



D ▶ Junior Pant Break-Up® Infinity™



WASATCH — A STYLE FOR EVERY NEED.

Wasatch Fieldwear is the finest line of camo clothing available. The foundation is the rugged, breathable, cotton-rich fabric that moves with you. In addition to our popular collared shirts, we also have a line of long- and short-sleeved T-shirts and a new Insulated Jacket, all designed to keep you comfortable when the temperatures rise or dip.



**NEW**



**E ▶** Hooded Insulated Jacket  
Break-Up®  
Infinity™



**F ▶** Long Sleeve Break-Up® Infinity™

**G ▶** Long Sleeve Treestand®



**WASATCH HOODED INSULATED JACKET**

7 oz. cotton/poly twill shell fabric · Brushed tricot lining · Smooth taffeta sleeve lining for easy on/off · 115 gr. body insulation, 85 gr. hood and sleeves insulation · Large front pockets with snap closures · Drawcord hood · Rib knit cuffs and elastic waistband · Sizes: S-3XL

NUMBER	DESCRIPTION	S	M	L	XL	2XL	3XL	SUGG. RETAIL
<b>E ▶</b> 30413720	<b>NEW</b> Mossy Oak Break-Up Infinity						S-XL 2XL-3XL	\$63.50 70.00
30413717	<b>NEW</b> Mossy Oak Duck Blind						S-XL 2XL-3XL	63.50 70.00

**WASATCH LONG SLEEVE T-SHIRT**

100% cotton jersey · Buckmark embroidery · Crew neck design · Mossy Oak® camo patterns · Sizes: S-3XL

NUMBER	DESCRIPTION	S	M	L	XL	2XL	3XL	SUGG. RETAIL
<b>F ▶</b> 30112020	Mossy Oak Break-Up Infinity						S-XL 2XL-3XL	\$18.00 23.00
30112017	Mossy Oak Duck Blind						S-XL 2XL-3XL	18.00 23.00
<b>G ▶</b> 30112018	Mossy Oak Treestand						S-XL 2XL-3XL	18.00 23.00

**WASATCH SHORT SLEEVE T-SHIRT**

100% cotton jersey · Crew neck design · Chest pocket with Buckmark embroidery · Mossy Oak® camo patterns · Sizes: S-3XL

NUMBER	DESCRIPTION	S	M	L	XL	2XL	3XL	SUGG. RETAIL
<b>H ▶</b> 30111920	Mossy Oak Break-Up Infinity						S-XL 2XL-3XL	\$15.00 18.00
30111917	Mossy Oak Duck Blind						S-XL 2XL-3XL	15.00 18.00
30111918	Mossy Oak Treestand						S-XL 2XL-3XL	15.00 18.00



**H ▶** Short Sleeve Break-Up® Infinity™





### BIG COUNTRY VEST

100% polyester fabric · Quiet and durable construction · Reinforced outer seams for durability · Quilted shoulder overlays · Advanced pocket design for carrying accessories · Includes Gear "Trievers" pocket · License tab · Large rear storage area · Sizes: S-3XL

NUMBER	DESCRIPTION	S	M	L	XL	2XL	3XL	SUGG. RETAIL
A ▶ 30541501	Blaze						S-3XL	\$64.00

### SAFETY VEST

100% polyester Oxford · Zip front · Back license loop · Large snap flap shell pockets · Buckmark embroidery on front and back · Sizes: S-3XL

NUMBER	DESCRIPTION	S	M	L	XL	2XL	3XL	SUGG. RETAIL
B ▶ 30510001	Blaze						S-3XL	\$20.00

### JUNIOR SAFETY VEST



Cut specifically for junior builds · Sizes: S (6-8), M (10-12), L (14-16), XL (18-20)

NUMBER	DESCRIPTION	S	M	L	XL	SUGG. RETAIL	
30550001	Blaze					S-XL	\$18.00



A ▶ Big Country Vest  
Blaze



B ▶ Safety Vest  
Blaze

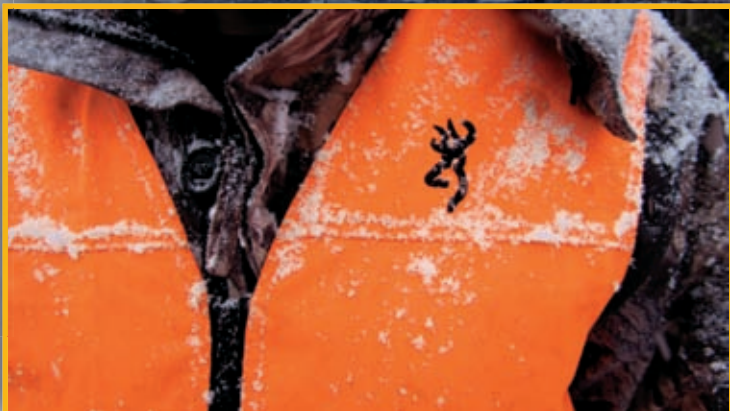





▶ Zip-Off Sleeve Jacket  
Field Tan



BELLOWS POCKETS WITH EXPANDER SYSTEM



ZIP-OFF SLEEVES



**PHEASANTS FOREVER ZIP-OFF SLEEVE JACKET**

12 oz., 100% cotton canvas · 100% polyester blaze overlay — over 400 square inches · Zip-off sleeves convert jacket into a vest · Available with Pheasants Forever embroidery · Large blood proof front load game bag with zip opening for easy cleaning · Shell pockets with the Pocket Expander System for easy conversion to exposed shell loops · Hook and loop pocket flap for easy shell pocket access · D-rings for dog training accessories · Corduroy lined collar · Two zippered front pockets · Two-way front zipper with snap storm flap · Adjustable cuffs · REACTAR™ pad pocket behind each shoulder patch (pad sold separately) · Sizes: S-3XL

NUMBER	DESCRIPTION	S	M	L	XL	2XL	3XL	SUGG. RETAIL
30411632	Field Tan, with Pheasants Forever logo embroidery						S-XL 2XL-3XL	\$105.00 117.00
▶ 30411932	Field Tan, without embroidery						S-XL 2XL-3XL	105.00 117.00

**PHEASANTS FOREVER — JOIN THE CAUSE.**

Without the conservation efforts of Pheasants Forever, millions of acres of prime pheasant habitat would be lost. Pheasants Forever chapters all over the United States work to protect, restore and enhance wildlife habitat by establishing and maintaining local and regional projects. From encouraging farmers to leave longer wheat stubble, to the purchase of upland habitat land, Pheasants Forever continues to work to preserve America's favorite game bird. To become a member or volunteer, please call toll free (877) 773-2070. With every purchase of a Browning Pheasants Forever product, Browning proudly makes a contribution to this most worthy conservation organization.









D ▶ Chaps  
Field Tan



E ▶ Pant  
Field Tan



F ▶ Back of Bibs (above) with blood proof game bag.  
Front of Bibs (below), Field Tan



### PHEASANTS FOREVER CHAPS

12 oz., 100% cotton canvas · Briar-resistant overlay · Double sized adjustment loops with hook and loop closures · Snap side opening for easy on and off · Available with Pheasants Forever embroidery · Sizes: Inseam lengths: 28" Regular, 31" Tall

NUMBER	DESCRIPTION	REG.	TALL		SUGG. RETAIL
D ▶ 30011632	Field Tan, with Pheasants Forever logo embroidery			28" Inseam	\$51.00
				31" Inseam	63.00
30011932	Field Tan, without embroidery			28" Inseam	51.00
				31" Inseam	63.00

### PHEASANTS FOREVER PANT

12 oz., 100% cotton canvas · Briar-resistant overlay · Comfortable, work pant style fit · Deep front pockets · Tool pockets on legs · Zipper fly · Flap rear pockets · Available with Pheasants Forever embroidery · Sizes: Inseam lengths: 30", 32", Waist sizes: 32"-44"

NUMBER	DESCRIPTION	32	34	36	38	40	42	44	SUGG. RETAIL
E ▶ 30211632	Field Tan, with Pheasants Forever logo embroidery								\$63.00
30211932	Field Tan, without embroidery								63.00

### PHEASANTS FOREVER BIBS

12 oz., 100% cotton canvas · Briar-resistant overlay · Detachable, blood proof game bag · Available with Pheasants Forever embroidery · Two large front shell pockets with the Pocket Expander System for easy conversion to exposed shell loops · Zipper fly · Waist tabs for size adjustment · Flap rear pockets · Adjustable shoulder straps · Sizes: S-3XL

NUMBER	DESCRIPTION	S	M	L	XL	2XL	3XL	SUGG. RETAIL
F ▶ 30611632	Field Tan, with Pheasants Forever logo embroidery							S-XL \$101.00
								2XL-3XL 115.00
30611932	Field Tan, without embroidery							S-XL 101.00
								2XL-3XL 115.00



# Bird'n Lite®

WIDE NYLON SHOULDER STRAPS TRANSFER THE LOAD TO YOUR SHOULDERS, YET STILL LET YOU SWING THROUGH THE BIRD NATURALLY

THE QUICK-RELEASE STERNUM STRAP HELPS KEEP THE WEIGHT CENTERED BETWEEN YOUR SHOULDERS FOR IMPROVED BALANCE AND LESS FATIGUE

## BIRD'N LITE — WHERE TRADITION AND INNOVATION COME TOGETHER.

Upland hunters are immersed in tradition. It's all about being afield with a good dog, a well-traveled Citori® and feeling the heft of shells and birds swinging in your favorite vest. Now's the time to upgrade your upland gear and check out Browning's new Bird'n Lite series. Bird'n Lite jackets and vests feature an integrated load-bearing system that lifts the load higher and balances it between your shoulders and hips for more comfort and stability, all without sacrificing the look of traditional upland hunting gear. With Bird'n Lite, you can carry more, with less effort, for far longer than you would ever have wanted to with your old hunting vest. Start a new tradition with Browning's new Bird'n Lite jackets and vests.

THE FULLY-ADJUSTABLE SIDE STRAPS LET YOU PLACE YOUR LOAD'S CENTER OF GRAVITY WHERE IT'S MOST COMFORTABLE TO CARRY

ERGONOMICALLY-CONTOURED, PADDED ADJUSTABLE WAIST BELT OFFERS ADDED SUPPORT TO YOUR LOWER BACK AND ALLOWS PART OF THE LOAD TO BE CARRIED ON YOUR HIPS FOR GREATER COMFORT

QUICK-RELEASE COMPOSITE BUCKLE ALLOWS FOR QUICK ON AND OFF, BOTH AT THE TRUCK OR IN THE FIELD





**BIRD'N LITE JACKET— YOU'LL NEVER GO AFIELD WITHOUT IT.**

Now you can have the best of both worlds - a state-of-the-art load carrying system built right into a traditional looking jacket you'll be proud to wear afield. Bird'n Lite jackets lift your load higher and let you select the ideal balance point between your shoulders and hips for both comfort and stability. The blaze orange shoulder and sleeve overlays let other hunters know exactly where you are, while the traditional khaki body helps hide the smudges and scuffs that are part of every upland hunt. The blood proof game bag is easy to access, and there are pockets galore for every item you might want to take into the field. When you're ready to load up and move out on your next upland hunt, you're ready for a Browning Bird'n Lite jacket.

Bird'n Lite®



**NEW**

A ▶ Jacket  
Khaki/Blaze with Pheasants  
Forever Logo Embroidery



STERNUM STRAP  
KEEPS SHOULDER  
STRAPS IN PLACE



SIDE STRAPS  
ARE ADJUSTED  
WITHIN GAME  
BAG POCKETS

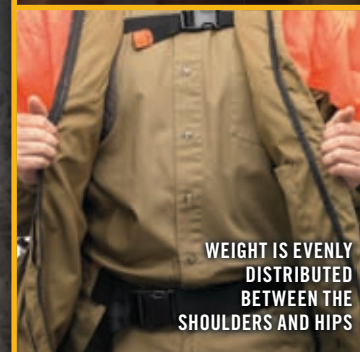

WEIGHT IS EVENLY  
DISTRIBUTED  
BETWEEN THE  
SHOULDERS AND HIPS



ADJUSTABLE WAIST  
BELT SECURES THE  
LOAD TO YOUR HIPS

**BROWNING BIRD'N LITE JACKET**

Browning Bird'n Lite Technology weight distribution system secures your load · Rugged, lightweight cotton/polyester shell fabric · Blaze shoulder overlays · Front-loading blood proof game bag with zip-top opening and load stabilizing strap · Oversized shell pockets with internal shell loops and snap closures · Built-in rucksack with elastic top and buckle strap closure · Zipper front · Transmitter pocket with antenna loop · REACTAR™ pad pockets behind each quilted shoulder patch (pad sold separately) · Lined handwarmer pockets behind shell pockets · Water bottle pockets · D-rings for accessories · Hook and loop adjustable elastic cuffs · Available with Pheasants Forever embroidery · Zip-through collar · License tab · Sizes: S-3XL

NUMBER	DESCRIPTION	S	M	L	XL	2XL	3XL	SUGG. RETAIL
A ▶ 30468958	<b>NEW</b> Khaki/Blaze with Pheasants Forever embroidery							S-XL \$162.00 2XL-3XL 175.00
30468858	<b>NEW</b> Khaki/Blaze, without embroidery							S-XL 162.00 2XL-3XL 175.00





# Bird'n Lite®

## BIRD'N LITE VEST — THE FINEST FOR THE FIELD.

If covering miles of open ground laden with shells, birds, water, lunch, a jacket, training transmitters and all the sundry items you need in the field make you think you need a backpack instead of an upland vest, take a gander at the new Browning Bird'n Lite Strap Vest. This innovative vest utilizes the patented Bird'n Lite Technology load bearing system that secures and distributes the weight of heavy loads, making walking all those miles much more comfortable. Gone are the days of heavy, swinging game bags, picking wet feathers off of your water bottle and rubbing sore shoulders. Hitch up a Bird'n Lite Strap Vest and enjoy hunting all over hill and dale.



A ▶ Strap Vest  
Khaki/Blaze

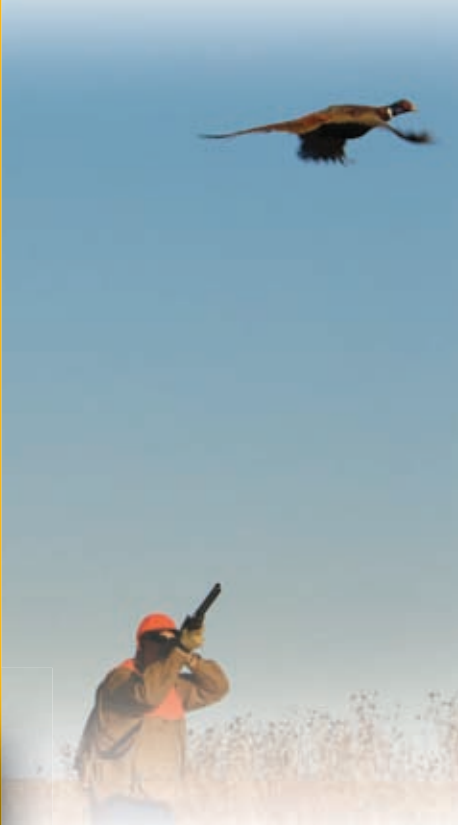

### BROWNING BIRD'N LITE STRAP VEST

Browning Bird'n Lite Technology weight distribution system secures your load · Rugged, lightweight cotton/polyester shell fabric · Padded blaze shoulder straps · Front-loading blood proof game bag with load stabilizing strap · Oversized shell pockets with internal shell loops and snap closures · Built-in rucksack with elastic top · Adjustable belt · Lined handwarmer pockets behind shell pockets · Water bottle pockets · D-rings for accessories · Available with Pheasants Forever embroidery · License tab · M/L, XL/2XL

NUMBER	DESCRIPTION	M/L	XL/2XL	SUGG. RETAIL
A ▶ 30068958	<b>NEW</b> Khaki/Blaze with Pheasants Forever embroidery			M/L, XL/2XL \$140.00
30068858	<b>NEW</b> Khaki/Blaze without embroidery			M/L, XL/2XL 140.00





**BIRD'N LITE VEST AND PANT — COMPLETE YOUR HUNTING OUTFIT.**

Complete your ensemble with the Bird'n Lite Vest and Pant. The vest offers all the latest Bird'n Lite features in a comfortable, more traditionally-styled upland bird vest. The pants have a relaxed fit for all-day comfort and are constructed of rugged poly/cotton twill with briar-resistant nylon overlays front and back. A zipper fly and snap-button flaps on the rear pockets make them perfect pair of pants for upland game. Both the Bird'n Lite Vest and Pant are available with Pheasants Forever embroidery.



**C ▶** Pant  
Khaki



**B ▶** Vest  
Khaki/Blaze

**BROWNING BIRD'N LITE VEST**

Browning Bird'n Lite Technology weight distribution system secures your load · Rugged, lightweight cotton/polyester shell fabric · Blaze shoulder overlays · Front-loading blood proof game bag with zip-top opening and load stabilizing strap · Oversized shell pockets with internal shell loops and snap closures · Built-in rucksack with elastic top · Zipper front · Transmitter pocket with antenna loop · REACTAR™ pad pockets behind each quilted shoulder patch (pad sold separately) · Lined handwarmer pockets behind shell pockets · Water bottle pockets · D-rings for accessories · Available with Pheasants Forever embroidery · Zip-through collar · License tab · Sizes: S-3XL

NUMBER	DESCRIPTION	S	M	L	XL	2XL	3XL	SUGG. RETAIL
<b>B ▶</b> 30568958	<b>NEW</b> Khaki/Blaze with Pheasants Forever embroidery							\$116.50
30568858	<b>NEW</b> Khaki/Blaze without embroidery							128.50

**BROWNING BIRD'N LITE PANT**

Rugged, lightweight cotton/polyester shell fabric · Briar-resistant nylon overlays on front face and back calf · Comfortable, relaxed fit · Boot cut for easy fit over boots · Zipper fly · Flap rear pockets with snap closures · Available with Pheasants Forever embroidery · Sizes: Inseam lengths: 30", 32", Waist sizes: 32"-44"

NUMBER	DESCRIPTION	32	34	36	38	40	42	44	SUGG. RETAIL
<b>C ▶</b> 30268958	<b>NEW</b> Khaki, with Pheasants Forever embroidery							30" Inseam	\$81.00
								32" Inseam	81.00
30268858	<b>NEW</b> Khaki without embroidery							30" Inseam	81.00
								32" Inseam	81.00



**A** ▶ Jacket  
Khaki/Loden



**B** ▶ Gloves  
Khaki/Loden



### CROSS COUNTRY WINDCUTTER JACKET

3-layer, 4-way stretch fabric features a hard-faced, abrasion-resistant nylon shell, windproof and water-repellent Windcutter™ laminate middle layer, and soft fleece lining · Highly breathable · Underarm ventilation zippers regulate heat · Two slash pockets, two chest pockets · Drawcord waist · Full-length zipper · Stand-up collar · Sizes: S-3XL

NUMBER	DESCRIPTION	S	M	L	XL	2XL	3XL	SUGG. RETAIL
<b>A</b> ▶ 30413040	Khaki/Loden							S-XL \$127.00 2XL-3XL 140.00

### CROSS COUNTRY WINDCUTTER GLOVES

Windproof, breathable Windcutter™ lamination · Dual waterproof leather/synthetic palm provides uncompromising grip and dexterity · Articulated fingers · Sensi-Flex Technology trigger finger for superior feel and articulation · Pull on fit · Sizes: S-2XL

NUMBER	DESCRIPTION	S	M	L	XL	2XL	SUGG. RETAIL
<b>B</b> ▶ 30710358	Khaki/Loden						S-2XL \$38.00

### CROSS COUNTRY UPLAND SHIRT

100% polyester fabric moves moisture away from the body · Blaze or Loden overlays and shoulder patch · REACTAR™ pad pocket (pad sold separately) · Angled front pocket · Sizes: S-3XL

NUMBER	DESCRIPTION	S	M	L	XL	2XL	3XL	SUGG. RETAIL
<b>C</b> ▶ 30119358	Khaki/Blaze							S-XL \$53.00 2XL-3XL 58.00
<b>D</b> ▶ 30119340	Khaki/Loden							S-XL 53.00 2XL-3XL 58.00

**C** ▶ Upland Shirt  
Khaki/Blaze



**D** ▶ Upland Shirt  
Khaki/Loden







Hood zips into collar



Elastic gussets on shell pockets



Articulated shoulders



**NEW**

E ▶ Pro Upland Jacket  
Khaki/Blaze



**NEW**

F ▶ Pro Upland Pant  
Khaki/Olive

### CROSS COUNTRY PRO UPLAND JACKET

160 denier nylon shell with water-resistant, windproof lining · New OverCast barrier design for water-resistant and windproof protection · Fully-taped seams in shoulders, collar and armholes for added waterproof protection · Brushed tricot body lining with taffeta sleeve lining for easy on and off · Full-length zipper with external storm flap · Olive or blaze shoulder overlays · Articulated shoulders for ease of movement · REACTAR™ pad pockets behind both shoulders (pad sold separately) · Front-loading blood proof game bag with drain holes and zip-top opening · Fleece-lined collar · Two double-pleated bellows pockets with magnetic flap closures, elastic gussets for easy pocket expansion and shell loops · Lined handwarmer pockets on chest and behind bellows pockets · Attached hood zips into collar · Hook and loop adjustable, water-resistant cuffs · Water bottle pockets · Internal security pockets · Sizes: S-3XL

NUMBER	DESCRIPTION	S	M	L	XL	2XL	3XL	SUGG. RETAIL
E ▶ 30414858	<b>NEW</b> Khaki/Blaze						S-XL 2XL-3XL	\$93.00 105.00
30414884	<b>NEW</b> Khaki/Olive						S-XL 2XL-3XL	93.00 105.00

### CROSS COUNTRY PRO UPLAND PANT

160 denier nylon shell with water-resistant, windproof lining · New OverCast barrier design for water-resistant and windproof protection · Fully-taped seams · Taffeta leg lining for easy on and off · Briar resistant nylon oxford overlays on front face and back calf · Comfortable, relaxed fit · Boot cut for easy fit over boots · Zipper fly · Flap rear pockets with snap closures · Fully-constructed waistband with kidney flap · Zip-to-knee leg openings with storm flaps · Articulated knees · Two front pockets, one rear pocket · Zippered fly · Sizes: S-3XL

NUMBER	DESCRIPTION	S	M	L	XL	2XL	3XL	SUGG. RETAIL
F ▶ 30214858	<b>NEW</b> Khaki/Olive						S-XL 2XL-3XL	\$53.00 58.00



A ▶ Overlay Shirt  
Dark Khaki/New Break-Up®

**REACTAR**



B ▶ Overlay Shirt  
Dark Khaki/Blaze

**REACTAR**



**UPLAND SHIRTS — COMFORTABLE FIT FOR DAY-LONG PERFORMANCE.**

Countless hours in the field have yielded a lineup of shirts designed to take comfort and durability to the next level. Browning Upland shirts provide you with easy mobility and a bind-free fit when shouldering a shotgun and swinging on game. Of course, these shirts are also stylish and look great when worn at your range or club.

**REACTAR**

C ▶ Upland Shirt  
Acorn/Olive



**REACTAR**

D ▶ Upland Shirt  
Olive/Acorn



**PRAIRIELANDS CANVAS OVERLAY SHIRT**

100% cotton sandwashed canvas · Bi-swing action back for comfort and mobility · Flap-closure pleated chest pocket · 100% cotton Mossy Oak® camo overlays · REACTAR™ pad pocket (pad sold separately) · Antique brass logo snaps · Spread collar · Sizes: S-3XL

NUMBER	DESCRIPTION	S	M	L	XL	2XL	3XL	SUGG. RETAIL
A ▶ 30111214	Dark Khaki/New Break-Up						S-3XL	\$61.00
B ▶ 30112483	Dark Khaki/Blaze						S-3XL	61.00

**PRAIRIELANDS UPLAND SHIRT**

100% cotton canvas · Contrasting sleeve and shoulder · Bi-swing action back for comfort and mobility · Chest pocket · REACTAR™ pad pocket (pad sold separately) · Padded shoulder patch · Longer sleeve placket for easy roll-up · Button-down collar · Sizes: S-3XL

NUMBER	DESCRIPTION	S	M	L	XL	2XL	3XL	SUGG. RETAIL
C ▶ 30113742	Acorn/Olive						S-XL 2XL-3XL	\$38.00 45.00
D ▶ 30115042	Olive/Acorn						S-XL 2XL-3XL	38.00 45.00

**POLO DOVE SHIRT**

Polo style design · Shooting patch overlay on right shoulder · Rib knit cuffs and collar · Soft pique cotton fabric · Differential cut · Available in Mossy Oak Break Up Infinity · Sizes: S-3XL

NUMBER	DESCRIPTION	S	M	L	XL	2XL	3XL	SUGG. RETAIL
E ▶ 30115820	<b>NEW</b> Mossy Oak Break-Up Infinity/Olive						S-XL 2XL-3XL	\$49.00 55.50



E ▶ Polo Shirt  
Mossy Oak®  
Infinity™/Olive

**NEW**





F ▶ Belted Game Bag Acorn



**NEW**

G ▶ Belted Dove Game Bag Break-Up® Infinity™



H ▶ Game Vest Break-Up® Infinity™



**NEW**

I ▶ Dove Vest Mossy Oak® Infinity™

**PRAIRIELANDS BELTED GAME BAG**

100% cotton canvas with rubberized mesh pocket to cool game · Extra pockets for choke tubes, sunglasses or dog training transmitter · Pocket for optional 1.5 liter hydration bladder · Game bag has blood proof lining and mesh sides · Leather belt with brass buckle · Sizes: M (34"-38"), L (38"-43"), XL (44"-49")

NUMBER	DESCRIPTION	M	L	XL	SUGG. RETAIL
F ▶ 30910583	Acorn				M-XL \$80.00

**BELTED DOVE GAME BAG**

100% poly oxford fabric · Web belt with adjustable buckle · Two large shell pockets with accessory pockets for choke tubes, glasses, etc. · Large blood proof game bag with mesh sides for ventilation · Pockets slide on belt for easy positioning · Snap closures · One size fits most

NUMBER	DESCRIPTION	ONE SIZE FITS MOST	SUGG. RETAIL
G ▶ 30910620	<b>NEW</b> Mossy Oak Break-Up Infinity	one size	\$31.50

**GAME VEST**

100% poly oxford · Front load blood proof game bag · Elasticized shell loops · Large bellows pockets · Mesh sides and back for lightweight and ventilation · Sizes: S-3XL

NUMBER	DESCRIPTION	S	M	L	XL	2XL	3XL	SUGG. RETAIL
H ▶ 30517020	Mossy Oak Break-Up Infinity						S-XL, 2XL-3XL	\$44.50 50.50

**DOVE VEST**

7 oz. 55/45 Cotton/poly twill fabric · Lightweight, comfortable design is ideal for hot weather · Mesh front and back panels provide greater breathability · Two bellows shell pockets · Blood proof rear game bag · Zippered front · Sizes: S-3XL

NUMBER	DESCRIPTION	S	M	L	XL	2XL	3XL	SUGG. RETAIL
I ▶ 30510320	<b>NEW</b> Mossy Oak Break-Up Infinity						S-XL, 2XL-3XL	\$25.00 31.00





A ▶ Reactar™ G2 Pad



**NEW REACTAR™ G2 PAD— NOW WITH IMPACT GEL™ FOR BETTER PERFORMANCE.**

Shooting all day can take a heavy toll on your shoulder. Take the sting out of shooting with the REACTAR G2 pad. Our newest REACTAR G2 pad features a totally new, ultra-flexible recoil absorption material called Impact Gel™ that absorbs recoil forces better than any other pad on the market. Most amazingly, the REACTAR G2 pad with Impact Gel performs so well at a thickness of only 8mm, it won't change your length of pull or affect your point of aim. To reap the benefits of greater comfort and less fatigue, try a new Made in the USA REACTAR G2 Pad today.

**REACTAR PAD G2 AND SHOOTING HARNESS**

**REACTAR Shooting Pad:** Browning's exclusive REACTAR™ pad (Recoil ACTION ARrestor) absorbs recoil on the inside of vest, jacket or shirt without altering appearance or increasing length of pull  
 · Uses patented, environmentally-friendly Impact Gel™ which reduces peak recoil · Only 8 mm thick  
 · Lightweight · Flexible to form to the body · Dimensions: 3¾" W x 7" L

**Harness:** Updated for better fit · Includes REACTAR pad · Heavy-duty 500 denier Cordura® · Reversible for use by right- or left-handed shooters · Elastic strap with buckle size adjustment · Sizes: One size fits most

NUMBER	DESCRIPTION	ONE SIZE FITS MOST	SUGG. RETAIL
A ▶ 309013	<b>NEW</b> REACTAR G2 Pad, Gray	one size	\$24.95
B ▶ 309011	REACTAR Harness, Black	one size	44.95

**SHOULDER SAVER REACTAR NTS SHIRT**

Lightweight, stretchable polyester/Lycra® jersey fabric has superb moisture-moving and quick-drying properties · Anti-microbial to help kill odor-causing bacteria · Designed to be worn snug, Next to Skin, to keep REACTAR Pad in place and move moisture · Oversized REACTAR Pad pocket on both shoulders (oversized REACTAR G2 pad included) · Sizes: S-3XL

NUMBER	DESCRIPTION	S	M	L	XL	2XL	3XL	SUGG. RETAIL
C ▶ 30101347	<b>NEW</b> REACTAR NTS Shirt, White						S-3XL	\$69.95



B ▶ Reactar™ Shooting Harness



C ▶ Reactar™ Shoulder Saver Shirt



*"There is no better endurance test on shooting gear than an Argentina dove hunt. After 3,300 shells fired in just three short days, I found Browning's new REACTAR Shirt really performs. It's comfortable to wear, the pad is soft and molds right to your shoulder. The generous pad is oversized to cover a larger area on your shoulder so you are protected no matter where you shoulder your gun. The pad is thin enough that it doesn't affect mounting the gun or the length of pull. Best of all, I had no bruising or soreness. It's a must-have for anybody planning a full day of shooting, and it lives up to our motto, The Best There Is." — Rafe Nielsen, Browning Product Manager*





DUSTY MESH VESTS — STAY COOL.

When temperatures soar and the competition heats up, keep your cool in a new Browning Dusty Mesh Vest. Constructed from lightweight polyester mesh and cotton stonewash twill, the Dusty Mesh Vest lets air circulate over your torso to evaporate perspiration, making you more comfortable and helping keep your mind on the clays. Large front pockets hold your shells and the large rear pocket gives you a place to carry those valuable empties. REACTAR™ pad (pad not included) pockets sit behind both shoulders so you can enjoy added recoil control as another feature of your soon to be favorite shooting vest.



**NEW**

**REACTAR**

D ▶ Stone/Tan



**NEW**

**REACTAR**

E ▶ Front and Back Clay/Tan



**NEW**



F ▶ Jr. Dusty Mesh Vest Clay/Tan



**NEW**

G ▶ Jr. Dusty Mesh Vest Stone/Tan



DUSTY MESH VEST

100% cotton, 10 oz. stonewash twill full-length shooting patches on right and left shoulders with sewn-in REACTAR™ pad pockets (pad sold separately) · 100% polyester mesh body for ventilation · Two-way front zipper · Bellows shell pockets · Side tab adjustments · Large back pocket for empties or other gear · Inside security pocket · Sizes: S-3XL

NUMBER	DESCRIPTION	S	M	L	XL	2XL	3XL	SUGG. RETAIL
D ▶ 30502369	<b>NEW</b> Stone/Tan						S-3XL	\$59.95
E ▶ 30502368	<b>NEW</b> Clay/Tan						S-3XL	59.95

JUNIOR DUSTY MESH SHOOTING VEST

100% cotton, 9.5 oz. cotton twill full-length shooting patches on right and left shoulders with sewn-in REACTAR™ pad pockets (pad sold separately) · 100% polyester mesh body for ventilation · Two-way front zipper · Large shell pockets · Side tab adjustments · Large back pocket for empties or other gear · Inside security pocket · Buckmark and Claymaster embroidery · Sizes: S (6-8), M (10-12), L (14-16), XL (18-20)

NUMBER	DESCRIPTION	S	M	L	XL	SUGG. RETAIL
F ▶ 30505368	<b>NEW</b> Clay/Tan					\$49.95
G ▶ 30505369	<b>NEW</b> Stone/Tan					49.95





A ▶ Vest  
Black/Tan



B ▶ Vest  
Brown/Tan



C ▶ Vest  
Pine/Tan

### BROKEN BIRDS SHOOTING VEST

Mesh body for ventilation · Full-length twill shooting patch with internal REACTAR™ pad pocket (pad sold separately) · Four large shell pockets · Bar tacks at stress points · Side tab adjustments · Large rear pocket for hulls and other gear · Claymaster logo on back · Sizes: S-3XL

NUMBER	DESCRIPTION	S	M	L	XL	2XL	3XL	SUGG. RETAIL
A ▶	30502099 Black/Tan, Right-Hand						S-3XL	\$54.95
B ▶	30502098 Brown/Tan, Right-Hand						S-3XL	54.95
C ▶	30502094 Pine/Tan, Right-Hand						S-3XL	54.95

### TRAPPER CREEK CANVAS HALF VEST

Adjustable polyester web belt · Double, oversized shell pockets · Mesh shell pouch with zip bottom for easy emptying · One size fits most

NUMBER	DESCRIPTION	ONE SIZE FITS MOST	SUGG. RETAIL
D ▶	30900799 Black/Tan	one size	\$34.95



D ▶ Canvas Half Vest  
Above: Front view  
Right: Back view  
Black/Tan





**NEW**

**REACTAR**



**E** ▶ Vest For Her Charcoal/Yellow

**NEW**

**REACTAR**



**G** ▶ Vest For Her Brown/Pink

**REACTAR**



**NEW**



**F** ▶ Vest For Her Black/Brown

### SPORTER II SHOOTING VEST FOR HER

Polyester mesh front and back · Cotton twill trim · Full-length quilted shooting patches on right and left shoulders with sewn-in REACTAR™ pad pockets (pad sold separately) · Button tab waist adjustment · Two-way front zipper · Larger rear pocket for hulls and other gear · Buckmark embroidered pocket and Claymaster embroidered back yoke · Interior security pocket · Sizes: S-2XL

NUMBER	DESCRIPTION	S	M	L	XL	2XL	SUGG. RETAIL
<b>E</b> ▶ 30506769	<b>NEW</b> Charcoal/Yellow					S-2XL	\$69.95
<b>F</b> ▶ 30506789	<b>NEW</b> Black/Brown					S-2XL	69.95
<b>G</b> ▶ 30506788	<b>NEW</b> Brown/Pink					S-2XL	69.95

### MOHAVE SHORT SLEEVE SHIRT FOR HER

100% polyester moisture-wicking pique fabric is perfect for hot weather · OdorSmart™ technology helps to control human odor · Excellent moisture transfer · Crew neck · Claymaster and Buckmark logo embroidery · Sizes: S-2XL

NUMBER	DESCRIPTION	S	M	L	XL	2XL	SUGG. RETAIL
<b>H</b> ▶ 30104341	<b>NEW</b> Pink					S-2XL	\$39.95



**NEW**

**H** ▶ Shirt Pink



A ▶ Deluxe Mesh Vest  
Charcoal/Brown



B ▶ Deluxe Mesh Vest  
Olive/Tan



C ▶ Santa Fe Vest  
Sage/Oak



**DELUXE MESH SHOOTING VEST**

Twill full-length shooting patch · Mesh body for ventilation · Two-way front zipper · Four large front shell pockets · Bar tacks at all stress points · Side tab adjustments · Large back pocket for empties or other gear · Built-in REACTAR™ pad system · Split shoulder for ease of movement · 60% cotton, 40% polyester twill · 100% polyester mesh · Sizes: Right-hand S-3XL, Left-hand M-2XL

NUMBER	DESCRIPTION	S	M	L	XL	2XL	3XL	SUGG. RETAIL
A ▶ 30501779	Charcoal/Brown, Right-Hand						S-3XL	\$99.95
B ▶ 30501784	Olive/Tan, Right-Hand						S-3XL	99.95
30502779	Charcoal/Brown, Left-Hand	N/A				N/A	M-2XL	99.95
30502784	Olive/Tan, Left-Hand	N/A				N/A	M-2XL	99.95

**SANTA FE PRO SHOOTING VEST**

Crazy Horse Leather full-length shooting patch and trim · Cotton twill and polyester mesh body for ventilation · Two-way front zipper · Four large front shell pockets · Bar tacks at all stress points · Back tab adjustments · Large back pocket for empties or other gear · Built-in REACTAR™ pad system · Split shoulder for ease of movement · 100% polyester mesh · Interior security pocket · Sizes: S-2XL

NUMBER	DESCRIPTION	S	M	L	XL	2XL	SUGG. RETAIL
C ▶ 30504154	Sage/Oak, Right-Hand					S-2XL	\$159.95

**SXS SUEDE SHOOTING VEST**

Polyester MicroSuede® full-length shooting patches on right and left shoulders with sewn-in REACTAR™ pad pockets (pad sold separately) · 100% polyester mesh body for ventilation · Two-way front zipper · Notched shoulders for easy movement · Four large shell pockets · Clip side adjustments · Large back pocket for empties or other gear · Inside security pocket · 3-D Buckmark embroidery on the front and Claymaster embroidery on the back · Sizes: S-3XL

NUMBER	DESCRIPTION	S	M	L	XL	2XL	3XL	SUGG. RETAIL
D ▶ 30501984	Olive/Brown						S-3XL	\$99.95



D ▶ SXS Suede  
Olive/Brown



**E ▶** Short Sleeve NTS Polo Sand

**F ▶** Short Sleeve NTS Polo Brown

**G ▶** Short Sleeve NTS Polo Pine

**J ▶** Short Sleeve NTS T-Shirt Pine

**I ▶** Short Sleeve NTS T-Shirt Brown

**MOHAVE SHORT SLEEVE NTS POLO**

100% polyester moisture-wicking pique fabric is perfect for hot weather · OdorSmart™ technology helps to control human odor · Excellent moisture transfer · Rib knit collar · Claymaster and Buckmark logo embroidery · Sizes: S-3XL

NUMBER	DESCRIPTION	S	M	L	XL	2XL	3XL	SUGG. RETAIL
<b>E ▶</b> 30104448	Sand						S-3XL	\$44.95
<b>F ▶</b> 30104488	Brown						S-3XL	44.95
<b>G ▶</b> 30104454	Pine						S-3XL	44.95

**MOHAVE SHORT SLEEVE NTS SHOOTING T-SHIRT**

100% polyester moisture-wicking pique fabric is perfect for hot weather · OdorSmart™ technology helps to control human odor · Excellent moisture transfer · Crew neck · Claymaster and Buckmark logo embroidery · Sizes: S-3XL

NUMBER	DESCRIPTION	S	M	L	XL	2XL	3XL	SUGG. RETAIL
<b>H ▶</b> 30104348	Sand						S-3XL	\$39.95
<b>I ▶</b> 30104388	Brown						S-3XL	39.95
<b>J ▶</b> 30104354	Pine						S-3XL	39.95

**BADGER CREEK SHORT SLEEVE WOVEN SHOOTING SHIRT**

100% garment-washed cotton · Internal REACTAR™ pad pocket behind shooting patch (pad sold separately) · Mesh-lined turbo vent back for maximum air circulation · Seven-button placket front · Button-down collar · Left front patch chest pocket · Sizes: S-2XL

NUMBER	DESCRIPTION	S	M	L	XL	2XL	SUGG. RETAIL
<b>K ▶</b> 30103448	Sand					S-2XL	\$44.95
<b>L ▶</b> 30103488	Brown					S-2XL	44.95
<b>M ▶</b> 30103454	Pine					S-2XL	44.95

**M ▶** Short Sleeve Shirt Pine

**K ▶** Short Sleeve Shirt Sand

**L ▶** Short Sleeve Shirt Brown

**H ▶** Short Sleeve, NTS T-Shirt Sand







**BALLISTIC INSULATED SHOOTING JACKET.**

Stay ahead of your shooting competitors by dusting targets year-round in the Ballistic Shooting Jacket. The waterproof, windproof, breathable Pre-Vent® fabric keeps hardcore shooters dry and protected from the wind while the Thermolite® insulation adds warmth. Oversized shell pockets feature magnetic closures that hold the pocket flaps open or closed.



A ▶ Jacket Sage/Tan



C ▶ Leather Tac-Pro Gloves Black

B ▶ Jacket Black/Green

**BALLISTIC INSULATED SHOOTING JACKET**

Pre-Vent® waterproof, windproof, breathable fabric · Warm Thermolite® insulation · Double shooting patches accommodate both right- and left-hand shooters · REACTAR™ pad pockets (pad sold separately) · Two bellows pockets with magnetic fasteners to hold flaps open or closed · Rib knit cuffs · Stand-up, zip-through collar · Brushed tricot lining · Two-way front zipper · Adjustable cuffs with hook and loop closures · Drawcord bottom · Buckmark and Claymaster embroideries · Sizes: S-3XL

	NUMBER	DESCRIPTION	S	M	L	XL	2XL	3XL	SUGG. RETAIL
A ▶	30401354	NEW Sage/Tan						S-3XL	\$129.95
B ▶	30401399	Black/Green						S-3XL	129.95

**LEATHER TAC-PRO GLOVES**

Unique textured palm enhances grip · Made from water- and perspiration-resistant Pittards® leather · Elasticized knuckles add comfort · Adjustable hook and loop closure with Buckmark embroidery · Washable, dries soft · Sizes: S-2XL

	NUMBER	DESCRIPTION	S	M	L	XL	2XL	SUGG. RETAIL
C ▶	30701290	Black					S-2XL	\$74.95

**MESH BACK SHOOTING GLOVES**

Lightweight, soft brushed synthetic suede · Stretch-mesh back for comfortable fit and enhanced air circulation · Hook and loop closure tab with Claymaster embroidery allows for adjustable, comfortable fit · Washable · Sizes: S-2XL

	NUMBER	DESCRIPTION	S	M	L	XL	2XL	SUGG. RETAIL
D ▶	30701188	Tan/Black					S-2XL	\$29.95
E ▶	30701190	Black					S-2XL	29.95

**TRAPPER CREEK MESH BACK SHOOTING GLOVES**

Lightweight, soft brushed synthetic suede · Stretch-mesh back for comfortable fit and enhanced air circulation · Comfortable pull-on style · Washable · Sizes: S-2XL

	NUMBER	DESCRIPTION	S	M	L	XL	2XL	SUGG. RETAIL
F ▶	30401399	Brown/Black					S-2XL	\$29.95

**TRAPPER CREEK MESH BACK SHOOTING GLOVES, FOR HER**

Lightweight, soft brushed synthetic suede · Stretch-mesh back for comfortable fit and enhanced air circulation · Comfortable pull-on style · Washable · Sizes: S-2XL

	NUMBER	DESCRIPTION	S	M	L	XL	2XL	SUGG. RETAIL
G ▶	30401488	Brown/Pink					S-2XL	\$29.95



D ▶ Mesh Back Shooting Gloves Tan/Black



E ▶ Mesh Back Shooting Gloves Black



F ▶ Trapper Creek Shooting Gloves Brown/Black



G ▶ Trapper Creek Shooting Gloves For Her Brown/Pink





**CAPS — THE RIGHT CAP FOR EVERYONE.**

You can always use another cap to shade your eyes from the sun, keep you warm in the cold weather or just hide a bad hair day. Our stylish caps are always comfortable, constructed of the finest materials and feature unique and attractive Buckmark logos. We offer a wide selection of Mossy Oak® camo pattern caps, plus lightweight designs to keep you cool and looking great during the summer shooting competition months. Enjoy the comfortable fit and feel of a Browning cap while proudly displaying your favorite brand.



CAPS			
NUMBER	DESCRIPTION	CLOSURE	SUGG. RETAIL
<b>RUGGED BUCKS</b>			
A ▶	308229581 <b>NEW</b> Khaki/MOINF	Hook and Loop Back	\$17.95
B ▶	308229621 <b>NEW</b> Orange/MOINF	Hook and Loop Back	17.95
C ▶	308229991 <b>NEW</b> Black/MONBU	Hook and Loop Back	17.95
<b>DEER SKULL AND RACK</b>			
D ▶	308227431 <b>NEW</b> Light Olive	Hook and Loop Back	11.95
E ▶	308227441 <b>NEW</b> Sand	Hook and Loop Back	11.95
F ▶	308227471 <b>NEW</b> Charcoal	Hook and Loop Back	11.95
<b>NORTHFORK TWILL WITH REPEL-TEX BRIM</b>			
G ▶	308005581 <b>NEW</b> Khaki/Brown	Hook and Loop Back	14.95
H ▶	308005431 <b>NEW</b> Yellow/Brown	Hook and Loop Back	14.95
I ▶	308005841 <b>NEW</b> Olive/Brown	Hook and Loop Back	14.95
<b>FALINE SPANGLE</b>			
J ▶	308510511 <b>NEW</b> Pink	Hook and Loop Back	14.95
K ▶	308510881 <b>NEW</b> Brown	Hook and Loop Back	14.95
<b>SHRIKE TWILL WITH 3-D BUCKMARK</b>			
L ▶	308004481 <b>NEW</b> Sand/Black	Hook and Loop Back	14.95
M ▶	308004541 <b>NEW</b> Sage/Black	Hook and Loop Back	14.95
N ▶	308004681 <b>NEW</b> Clay/Black	Hook and Loop Back	14.95
<b>CORONADO PIQUE WITH BUCKMARK</b>			
O ▶	308007471 <b>NEW</b> White/Black	Flex Fit	17.95
P ▶	308007991 Black	Flex Fit	17.95





**CAPS**

NUMBER	DESCRIPTION	CLOSURE	SUGG. RETAIL
<b>BREEZE MESH BACK SOLID</b>			
<b>A ▶</b>	308325241 <b>NEW</b> Pink	Hook and Loop Back	\$11.95
<b>B ▶</b>	308325381 <b>NEW</b> Olive	Hook and Loop Back	11.95
<b>C ▶</b>	308325681 <b>NEW</b> Tan	Hook and Loop Back	11.95
<b>TWILL WITH 3-D BUCKMARK AND BRIM SANDWICH</b>			
<b>D ▶</b>	308304841 Olive	Hook and Loop Back	14.95
<b>E ▶</b>	308304521 Terra Cotta	Hook and Loop Back	14.95
<b>F ▶</b>	308304681 Mocha	Hook and Loop Back	14.95
<b>G ▶</b>	308304711 Red	Hook and Loop Back	14.95
<b>H ▶</b>	308304791 Charcoal	Hook and Loop Back	14.95
<b>I ▶</b>	308304211 Pink/Brown	Hook and Loop Back	14.95
<b>DURA WAX SOLID</b>			
<b>J ▶</b>	308412511 Brown/Pink	Hook and Loop Back	19.95
<b>LITE WAX WITH CORPORATE LOGO</b>			
<b>K ▶</b>	308412581 Khaki	Hook and Loop Back	19.95
<b>DURA WAX SOLID</b>			
<b>L ▶</b>	3084121 Brown	Hook and Loop Back	19.95
<b>M ▶</b>	308412381 Olive	Hook and Loop Back	19.95
<b>DURA WAX WITH 3-D BUCKMARK</b>			
<b>N ▶</b>	308412881 Brown	Hook and Loop Back	19.95
<b>REPEL-TEX CLOTH TWO TONE WITH 3-D BUCKMARK</b>			
<b>O ▶</b>	308110341 Acorn/Olive	Hook and Loop Back	19.95
<b>STRAW WITH REPEL-TEX BRIM</b>			
<b>P ▶</b>	308106881 Brown	Hook and Loop Back	19.95





**SAFETY BLAZE CAPS — A SMART CHOICE IN THE FIELD.**

A little visibility goes a long way, and wearing a Blaze cap in the field is a good idea. When upland hunting, a Blaze cap helps communicate to your hunting partners where you are in a corn field or tall grass. When big game hunting, Blaze lets other hunters see you from hundreds of yards away. But don't think for a second that a Blaze cap has to be boring. Browning offers several styles of Blaze caps that are both highly visible and look cool enough to wear to the mall and make it easier for your significant other to find you there, too.



CAPS				
NUMBER	DESCRIPTION	CLOSURE	SUGG. RETAIL	
<b>SAFETY WITH 3-D BUCKMARK</b>				
<b>Q</b>	30840501	Blaze/Black	Hook and Loop Back	\$14.95
<b>SAFETY PLUS WITH 2-STRIPE BRIM</b>				
<b>R</b>	308117011	Blaze/Yellow	Hook and Loop Back	14.95
<b>SAFETY PLUS WITH 3-D BUCKMARK</b>				
<b>S</b>	308461001	Blaze/Yellow	Hook and Loop Back	14.95
<b>EASTFORK BLAZE</b>				
<b>T</b>	308125011	Blaze/Black	Hook and Loop Back	14.95
<b>EASTFORK BLAZE ROCKY MOUNTAIN ELK FOUNDATION</b>				
<b>U</b>	308125011R	Blaze/Black	Hook and Loop Back	14.95
<b>SAFETY PHEASANTS FOREVER EMBROIDERY</b>				
<b>V</b>	308126011	Blaze	Hook and Loop Back	14.95
<b>DEER SKULL AND RACK</b>				
<b>W</b>	308227201	<b>NEW</b> MOINF	Hook and Loop Back	14.95
<b>51 FIELD</b>				
<b>X</b>	308151201	<b>NEW</b> MOINF	Flex Fit	17.95
<b>BIG BUCKMARK AND CAMO</b>				
<b>Y</b>	308204201	<b>NEW</b> MOINF/Black	Hook and Loop Back	14.95
<b>Z</b>	308204141	MONBU/Black	Hook and Loop Back	14.95
<b>RIDGWAY 2-TONE</b>				
<b>AA</b>	308324201	Black/MOINF	Hook and Loop Back	14.95
<b>BREEZE MESH BACK</b>				
<b>BB</b>	308325201	MOINF/Tan	Hook and Loop Back	11.95
<b>GUNNER CAMO</b>				
<b>CC</b>	308129201	<b>NEW</b> MOINF/Black	Flex Fit	17.95
<b>DD</b>	308129202	<b>NEW</b> MOINF/Pink	Hook and Loop Back	17.95
<b>3D BUCKMARK LOW PROFILE FOR HER</b>				
<b>EE</b>	308179202	MOINF/Pink	Hook and Loop Back	14.95







**CAPS**

NUMBER	DESCRIPTION	CLOSURE	SUGG. RETAIL
<b>CAMO 3-D BUCKMARK</b>			
<b>A</b> ▶	308479141 MONBU	Hook and Loop Back	\$14.95
<b>B</b> ▶	308479161 MOBR	Hook and Loop Back	14.95
<b>C</b> ▶	308479171 MODB	Hook and Loop Back	14.95
<b>D</b> ▶	308479181 MOTS	Hook and Loop Back	14.95
<b>E</b> ▶	308479201 MOINF	Hook and Loop Back	14.95
<b>CAMO WITH 3-D ARCH LOGO</b>			
<b>F</b> ▶	308498201 MOINF	Hook and Loop Back	14.95
<b>G</b> ▶	308498141 MONBU	Hook and Loop Back	14.95
<b>EASTFORK CAMO</b>			
<b>H</b> ▶	308125181 MOTS	Hook and Loop Back	14.95
<b>I</b> ▶	308125201 MOINF	Hook and Loop Back	14.95
<b>J</b> ▶	308125201R MOINF (RMEF)	Hook and Loop Back	14.95
<b>NEEDLES ALLTERRAIN CAMO WITH BUCKMARK</b>			
<b>K</b> ▶	308323291 Green	Hook and Loop Back	14.95
<b>L</b> ▶	308323241 Pink	Hook and Loop Back	14.95
<b>WOODLAND CAMO</b>			
<b>M</b> ▶	308121411 Pink	Hook and Loop Back	14.95
<b>TATTER ALLTERRAIN CAMO WITH FELT BUCKMARK</b>			
<b>N</b> ▶	308119241 Pink	Clasp Tab	11.95
<b>O</b> ▶	308119291 Green	Clasp Tab	11.95
<b>DIGI CAMO</b>			
<b>P</b> ▶	308506291 Digi Desert	Hook and Loop Back	14.95





**HATS/CAPS**

NUMBER	DESCRIPTION	CLOSURE	SUGG. RETAIL
<b>JACK FELT</b>			
<b>Q ▶</b> 308327311	<b>NEW</b> Red/Black	Hook and Loop Back	\$17.95
<b>KENAI KNIT BEANIE</b>			
<b>R ▶</b> 308509541	<b>NEW</b> Sage	One Size	9.95
<b>S ▶</b> 308509991	<b>NEW</b> Black	One Size	9.95
<b>BISMARK LITE FELT/OVERDYE HAT</b>			
<b>T ▶</b> 30828028	Woods	S-M-L-XL	69.95
<b>U ▶</b> 30828088	Pecan Olive Drab	S-M-L-XL	69.95
<b>QUIK CAMO FACE MASK</b>			
<b>V ▶</b> 308128171	MODB	Hook and Loop Back	39.95
<b>W ▶</b> 308128201	MOINF	Hook and Loop Back	34.95



**QUIK CAMO™ FACE MASK CAP**

Brushed tricot fabric is quiet when moving through brush  
 · Patent pending design features a drop down mesh face mask that hides the face quickly and easily  
 · Face mask uses quick-drying, moisture-wicking breathable fabric  
 · Eyewear compatible  
 · Ear holes for unobstructed hearing  
 · Mouth port for call access  
 · Adjustable back  
 · MODB cap has ear flaps  
 · Buckmark embroidery



**CLOTHING SIZING CHART**

**FOR HER SIZES**



	S		M		L		XL		2XL
SIZE	4	6	8	10	12	14	16	18	20
Neck	11½"	12½"	12½"	13½"	13½"	14½"	14½"	15½"	15½"
Sleeve	30"	30"	31"	31"	32"	32"	33"	33"	34"
Bust	33½"	34½"	35½"	36½"	38"	39½"	41"	43"	45"
Waist	25½"	26½"	27½"	28½"	30"	31½"	33"	35"	37"
Hip	35½"	36½"	37½"	38½"	40"	41½"	43"	45"	47"
Inseam	30"	30"	30"	30"	32"	32"	32"	32"	32"

**JUNIOR SIZES**



	S		M		L		XL	
Size	6	8	10	12	14	16	18	20
Height	45-48"	49-52"	53"	58"	59"	63"	66½"	68½"
Chest	26"	27"	28"	30"	31"	33"	35"	36½"
Waist	22½"	23½"	24"	25"	26"	27"	29"	30"
Hip	27"	28"	30"	32"	33"	34"	34"	35½"

Kid's caps: 6½", fits ages 18 months to 3 years old  
 Youth caps: 6⅞", fits ages 4-9

**MEN'S SIZES**

**MEN'S APPAREL**

Every garment is designed and built to the specifications on the charts below. Offered in 3XL sizes in many styles, which are cut larger throughout.

Size	Chest	Waist	Neck	Arm
S	37-39"	28-31"	14-14½"	32-33"
M	40-42"	32-35"	15-15½"	33-34"
L	43-45"	36-39"	16-16½"	34-35"
XL	46-48"	40-43"	17-17½"	35-36"
2XL	49-51"	44-46"	18-18½"	36-37"
3XL	52-54"	47-49"	18-19"	36-37"

**MEN'S GLOVES**

Measure around the flat of the hand just below the knuckles, excluding the thumb. Number of inches around hand equals glove size.

XS	7-7½"
S	8-8½"
M	9-9½"
L	10-10½"
XL	11-11½"





**BUCKMARK DECALS**

DESCRIPTION	SIZE	COLOR	CODE #	UPC #	SUGG. RETAIL
<b>FLAT DECALS</b>					
Buckmark Decal	4"	Camo	3922001914	023614115021	\$2.95
Buckmark Decal	4"	White	3922004714	023614115038	2.95
Buckmark Decal	4"	Silver	3922005914	023614115403	2.95
Buckmark Decal	4"	Gold	3922007314	023614115052	2.95
Buckmark Decal	4"	Black	3922009914	023614115045	2.95
Buckmark Decal	6"	Camo	3922002916	023614115076	4.95
Buckmark Decal	6"	Red/White/Blue	3922003116	023614115069	4.95
Buckmark Decal	6"	Pink	3922004116	023614012733	4.95
Buckmark Decal	6"	White	3922004716	023614115083	4.95
Buckmark Decal	6"	Hot Pink	3922005116	023614012740	4.95
Buckmark Decal	6"	Silver	3922005916	023614115427	4.95
<b>NEW</b> Buckmark Decal	6"	Chrome Silver	3922006916	023614365877	4.95
Buckmark Decal	6"	Gold	3922007316	023614115106	4.95
Buckmark Decal	6"	Black	3922009916	023614115090	4.95
Buckmark Decal Reflective	6"	Amber	3922070642	023614017615	5.45
Buckmark Decal Reflective	6"	Red	3922070661	023614017622	5.45
<b>3-D DECALS</b>					
Buckmark Decal	12"	Camo	3922002911	023614115120	\$14.95
Buckmark Decal	12"	Red/White/Blue	3922003111	023614115113	14.95
Buckmark Decal	12"	White	3922004711	023614115137	14.95
Buckmark Decal	12"	Gold	3922007311	023614115151	14.95
Buckmark Decal	6"	Camo	3922012916	023614115175	14.95
Buckmark Decal	6"	Red/White/Blue	3922013116	023614115168	14.95
Buckmark Decal	6"	Silver	3922015916	023614115182	14.95
Buckmark Decal	6"	Gold	3922017316	023614115205	14.95
Buckmark Decal	6"	Black	3922019916	023614115199	14.95
Buckmark Decal Lightning	6"	Black/Pink	3922060651	023614017608	14.95
Buckmark Decal Lightning	6"	Black/Gold	3922060673	023614017592	14.95
Claymaster Decal	3.5"	Orange	3922054	023614167884	9.95
<b>NEW</b> Daisy Buckmark Decal	5"	Black/Pink	3922080551	023614362326	9.95
<b>NEW</b> Deer & Skull	5"	Black/Red	3922080561	023614362319	9.95
<b>NEW</b> Deer & Skull	5"	Black/Gold	3922080573	023614362302	9.95
<b>NEW</b> Deer & Skull	15"	Black/Gold	3922081573	023614364047	17.95
<b>NEW</b> Bouquet Buck	5"	Black/Pink	3922090551	023614362333	9.95
<b>NEW</b> Rugged Rack Trio	5"	Black/Orange	3922090582	023614363118	9.95
Buckmark Family Decal	6"	MOBU/Pink	3922100014	023614019107	19.95

- High-quality vinyl resists cracking and fading
- Easy to apply and remove
- Wide variety of colors and styles
- Three sizes



Buckmark Decal Family - Camo/Pink



Bouquet Buckmark Black/Pink



Claymaster



# BROWNING PRO STAFF



**RICK CAMUGLIA** is a long-time Browning shooter with multiple sporting clays titles, nearly all won with Browning autoloading shotguns. A short list of his victories includes multiple National and Regional FITASC Championships, nine-time New Mexico State Champion, two-time HOA Arizona State Champion and two-time HOA Colorado State Champion. He is also an eight-time NSCA All-American Team member. Rick prefers to shoot the new Maxus® autoloader.

**ANDY DUFFY** is the only shooter to win three NSCA National Championships with back-to-back wins in 1994 and 1995. He has been on the NSCA All American Team 17 times, Team USA 20 times and won more world, national and local sporting clays championship titles than he can shake a stick at. In 2005, he was honored by being inducted into the NSCA Hall-of-Fame. When Andy isn't dusting clays with his Citori®, you will find him instructing others in the ways of shotgunning.



**MATT HUGHES** is a nine-time UFC® World Welterweight Champion and was inducted into the UFC Hall of Fame in 2010. Matt's toughness and work ethic are legendary in the UFC, something he attributes to growing up on a farm in rural Illinois. Matt spent a good portion of his early years hunting and shooting — passions that have never left him. Matt is now the frontman for Browning's Double Barrel Militia.



**JOHNNY MEITZEN** started shooting competitively in 1987 and is currently a NSCA Level III instructor. He has won a number of shooting titles including two-time NSCA Nationals Vet Champion and two-time NSCA Nationals FITASC Vet Champion. Johnny is a six-time All-American Sporting Team member, two-time Team USA Sporting member and two-time Team USA FITASC member. He also has many state and zone championship titles to his credit. Johnny is a die-hard Citori® man. His current model of choice is the Citori 625 Sporting.

**DEEANN MASSEY** was introduced to sporting clays shooting by her husband Jeff, who taught her to shoot in their backyard. She shot in her first tournament in the summer of 1996. In 1997, ten days before the Sporting Clays National Championship, she purchased her first 12 gauge Browning Gold. She used the Gold to tie for Ladies High Overall. Since then she has won two National Championships and has been a five-time runner-up. She has been on the 1st All American Team twelve times and Team USA seven times. She has also won the Michigan State Ladies Championship twelve times, the Zone Three Ladies Championship ten times and has numerous other wins in local and regional competition. She has been a member of the Browning Pro Staff Team for twelve years. DeeAnn currently shoots the Cynergy® over and under.





# BROWNING PRO STAFF



**ROBBIE PURSER** started shooting skeet at the tender age of six. Over the years he has accumulated an impressive list of shooting titles including 1980 World Skeet Champion, 1991 and 1998 NSCA Champion, Zone 4 Champion, Quail Unlimited Champion, four-time Ducks Unlimited Champion, 2002 Sportsman Team Challenge Champion and an ESPN Great Outdoor Games gold medalist. He is also a twelve-time All-American Team member, a member of Team USA and a ten-time Georgia State Champion. All told, Robbie has more than 200 tournament wins to his credit — all with Browning autoloaders.

**FRED ZINK** is the newest Browning Pro Staff member. Fred founded Zink Calls™ in 2001 primarily to fulfill the needs of waterfowlers and professional callers who demanded high-end calls. A nationally-recognized goose caller in his own right, Zink's business continues to grow and set new standards in the call industry. Zink's high-octane 24/7 DVD series is designed to speak to hunters with exciting footage that shares the hunting experience with the viewers. In 2011, look for Fred to be shooting the Browning Maxus® as he continues his quest to bring new hunters into the sport and grow the outdoor industry.



**BRODY SIKES** is a rising star on the clay target scene, recently winning the 2010 North American Grand Prix FITASC event at Claythorne Lodge. Just 20 years old, Brody shoots a Browning Citori® for clay targets and a Silver® in the blind. A product of the popular SCTP development program, Brody and his Citori will be in the winner's circle for years to come.



When **ZAC COOPER** was born, his parents decided that instead of giving up hunting for a while, they would adapt to new ways of hunting. And at four months of age, Zac was on a plane to Iowa for a whitetail hunt. He took his first two deer at age five, and hunting has since become a way of life for Zac. Now thirteen, Zac has gained national recognition for his speaking ability. He has been a guest speaker at such events as the 2009 QDMA National Convention, the University of Florida's Field Day, the Sportsman's Spectacular, and Florida's National Field Day. Zac is also a leader in school, serving in student government while maintaining straight-A grades. Zac has two long-term goals: To be a positive influence on today's youth and to help get them into the sport of hunting. See him in his debut hunting DVD titled "Little Man, Big Dreams."



**STEPHEN LE BLANC** is a man of many talents. He has a degree in wildlife biology, is a master taxidermist, an award-winning wildlife sculptor and an avid hunter. His impressive list of talents, coupled with an easy going, personable demeanor made him the perfect candidate to host our new television program "Browning Expeditions." His impressive hunting résumé includes a North American Grand Slam of sheep and the Africa Big Five that consists of elephant, white rhino, cape buffalo, lion and leopard.



**KRISTY LEE COOK** brought her amazing voice to the TV screen on the 9th season of "American Idol®." Now Kristy is a rising country music singer and hosts the Browning-sponsored TV show "Goin' Country." Kristy's husband Andy introduced her to hunting and she has since become a fanatic. Kristy possesses an infectious passion for everything she does, whether it is performing, hunting or saving horses through the Kristy Lee Horse Heaven Foundation.







**BROWNING**  
BELTS

The Best There Is<sup>®</sup>

646.896.1531  
www.browningleatherbelts.com



**BROWNING**  
OUTDOOR COOKWARE<sup>®</sup>

Now you can satisfy that urge to be a master Dutch oven chef. The Browning cast iron starter kit has everything you need to be a black pot professional. This kit is the perfect accessory for whatever you are cooking, at home or in the back country, and will help to make sure every meal is a masterpiece.

All Browning cast iron is pre-seasoned and ready to cook right out of the box. Easy to clean and maintain, Browning cast iron will be a family heirloom for generations.

**CAST IRON SET**

CBOX-BR



- 12" Dutch Oven
- 12" Skillet
- 12" Universal Lid
- Gloves
- Lift Tool

Made Exclusively By:



www.campchef.com



**Tow & Stow™ Receiver Hitch**

- Multiple Ball Sizes: 25/16", 2" & 1 7/8"
- Available in 3 adjustment lengths
- Raise or lower the hitch for a safe level tow
- Manufactured from steel
- Powder coated for a durable and long lasting finish
- 10,000 lbs. Trailer Weight /1,000 lbs. Tongue Weight



**BROWNING**  
HITCHES<sup>®</sup>







**BROWNING**  
FOOTWEAR



**BR9308** Men's Waterproof Moc Toe Chukka



**BR9216** Men's 8" Waterproof Insulated Mossy Oak Camo



**BR9105** Men's Waterproof Ranch Wellington

1.800.441.4319 • [www.browningfootwear.com](http://www.browningfootwear.com)

**Browning Hosiery Sock Collection**



Snake Boot    Western Boot    Merino Wool    Camo Merino Wool



Work Sock Dry Comfort    Merino Wool Hiker    Women's Angora Boot    Kid's Merino Wool

**Comfort and Protection for all Hunting, Hiking, Work and Casual Settings**

Carolina Hosiery Mills    email: [ekoury@carolinahosiery.com](mailto:ekoury@carolinahosiery.com)  
tel 336.226.5581 | fax 336.226.9721 | [www.browninghosiery.com](http://www.browninghosiery.com)



*YOU KNOW BROWNING MAKES THE BEST SHOOTING GLASSES.  
NOW YOU CAN WEAR BROWNING CASUAL EYEWEAR  
AFTER YOU LEAVE THE RANGE.*

(Shooting glasses are found on page 152)



Browning Eyewear and Accessories offer fashionable eyewear styles that allow the wearer to sport the Buckmark around town while protecting their vision from harmful UV rays. ®

The Elite series offer fashion conscious TR90 frames with clear distortion free CR39 lens. The Armour series offers durable Polycarbonate frames with our soft touch finish and TAC lens. The durable frames and polarized lenses offer maximum comfort to minimize eye strain. A line of branded accessories is also available.

See the full line of Browning Eyewear and Accessories at  
[www.browningeyewear.com](http://www.browningeyewear.com)  
800.416.0866





# WE OUTFIT YOU AND YOUR RIDE

## BROWNING APPAREL



## BROWNING AUTOMOTIVE

## BROWNING GIFTS



CONTACT SALES AT:  
[www.browningcs.com](http://www.browningcs.com)  
1.888.235.4078



# KIMLOR

INNOVATIVE HOME FASHIONS



[www.kimlor.com](http://www.kimlor.com)

Phone 800.762.0007

Fax 800.232.9060

These products manufactured and distributed by  
Kimlor Mills, Inc. Orangeburg, SC 29118

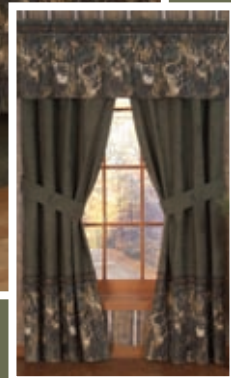
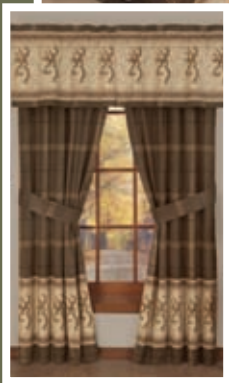

**BROWNING**®

BED AND BATH





## BROWNING® FISHING

Check out the new line of equipment from **Browning® Fishing in 2011.**

Topping off the broad range of Browning® fishing products are the revolutionary Midas baitcasting reels—five state-of-the-art models that offer exceptional casting distance, amazing accuracy and the ability to perfectly fit any rod. Also in the lineup for 2011, Browning® has perfected the take-along tackle bag with the 370 Satchel. In addition to its rugged construction, this one-of-a-kind tote provides room for all the gear you need.

BP101292

# FEED YOUR FEVER

GET GEAR PERFECT FOR ANY KIND OF FISHING



### Browning® 370 Satchel

For that next big fishing trip, grab the Browning® 370! This large and tough bag lets you safely take along all your favorite fishing gear. • Durable PVC-backed nylon • Top-loading compartment for six 370 tackle boxes • Molded sunglass holder • Zippered side compartments • Removable shoulder strap • Secure, easy-access tool storage • Mesh rear pocket w/zipper • Color: Green/Gray • Imported • 20"x12"x15"



### Browning® Midas Baitcast Reel

With five "10-class" reels to choose from, Browning has a top-of-the-line, yet compact, Midas baitcaster that's ideal for any kind of fishing. • Powerful 1-pc. aluminum frame • Double-anodized, forged-aluminum V-spool • Aluminum recurve handle & drag star • 9 double-shielded stainless steel bearings, plus the Powerlock™ instant anti-reverse roller bearing • Externally-adjustable Fail-Safe Dual Braking w/centrifugal & magnetic cast control • Thumb bar spool release

FOR INFORMATION, PLEASE CALL: 1-800-227-7776  
WWW.BROWNINGFISHING.COM

# 700 FPS! (600 FPS in .22 cal)



Available in  
.177 or .22 caliber

  
**BROWNING®**  
AIRGUNS

Introducing the Browning 800 MAG. **Anti-recoil** power system, **fiber optic** sights, **ambidextrous** ergonomic pistol grip, and an **automatic** safety make this break barrel pellet pistol a must have. Ask for the **Browning 800 MAG.**



©2010 Umarex USA • 7700 Chad Colley Blvd. • Fort Smith, AR 72916 • www.UmarexUSA.com

BROWNING.COM





When going afield take...  
The Best There Is...  
take **BROWNING**®



[www.browningbags.com](http://www.browningbags.com)

AmeriBag Outdoors • 5 AmeriBag Drive • Kingston, NY 12401 • 800.237.3224



 NEW For 2011  
Browning Camping For Her



Browning has a rich tradition of providing exceptional products for the avid outdoorsman, and the Browning Camping line is no exception. Our furniture is wider and stronger, our pads and mats are thicker and more comfortable, and our tents and sleeping bags use larger zippers and better fabric. Along with all the other new and exciting products Browning Camping has to offer for 2011, we now have products designed specifically "for her." Be sure to check out the Pink Browning items listed on our website.

The Best There Is®

1.877.459.2825  
[www.browningcamping.com](http://www.browningcamping.com)



Sleeping Bags • Furniture • Tents • Air Pads



# POLARIS® AND BROWNING®, MASTERS OF THE HUNT.



Polaris offers hunt-ready machines with premium features worthy of the Browning name. To see the complete line of Browning Limited Edition Polaris ATVs and Side x Sides, visit [BrowningOffRoad.com](http://BrowningOffRoad.com).



RANGER XP® 800  
BROWNING LIMITED EDITION



SPORTSMAN XP® 850 EPS  
BROWNING LIMITED EDITION



SPORTSMAN® 550 EPS  
BROWNING LIMITED EDITION

Vehicles are shown with optional equipment. Warning: ATVs can be hazardous to operate. For your safety, avoid operating Polaris ATVs or RANGERS on paved surfaces or public roads. Riders and passengers should always wear helmets, eye protection, protective clothing, and seat belts (on RANGEH vehicles). Never carry passengers unless the vehicle has been designed by the manufacturer for that purpose. Polaris adult ATV models are for riders aged 16 and older. Drivers of RANGEH vehicles must be at least 16 years old with a valid driver's license. All ATV riders should take a safety training course. For ATV safety and training information in the U.S., call the SVIA at (800) 697-2697, see your dealer, or call Polaris at (800) 342-3764. In Canada, see your local Polaris dealer about Polaris ATVs. Check your local laws before riding on trails. ©2010 Polaris Industries Inc.



PRSRTP BPM  
U.S. POSTAGE PAID  
PERMIT 179  
OGDEN, UT

BROWNING  
ONE BROWNING PLACE  
MORGAN, UT 84050

**BE A SAFE SHOOTER** Read and follow all safety information in the owner's manual provided with each firearm before using the firearm. Additional copies are available for free download on the Browning website. Browning endeavors to make the safest firearms possible, however, firearm safety begins with you. At all times treat any firearm with intense respect for its power and potential danger. Always point the muzzle in a safe direction. There is no excuse for careless or abusive handling of any firearm.



**BROWNING IS COMMITTED TO SERVING YOU** Every effort has been made to ensure that all product photographs, descriptions and specifications in this workbook are accurate; however, inadvertent errors may occur. Changes in design or materials due to our continual effort to improve products may result in specification changes before subsequent publications are issued. Browning reserves the right to modify or change specifications without notice. If you have any questions regarding Browning products, please write to Browning, One Browning Place, Morgan, UT 84050-9326.



**BROWNING**<sup>®</sup>

Browning ▶ One Browning Place ▶ Morgan, UT 84050-9326  
Distributed in Canada by: Browning Canada Sports Ltd/Ltée  
5583 Chemin St-François ▶ St-Laurent, Quebec H4S 1W6

**BROWNING.COM 800-333-3288**

©Copyright, Browning, December 2010. No part of this catalog may be reproduced without the written permission of Browning. Printed in U.S.A. GAC1009200/10062