

BROWNING

2010 CATALOG



Your moment deserves "The Best There Is®"

SHOTGUNS ► BEGIN ON PAGE 2

10 GAUGE SHOTGUNS: Gold & BPS	31
AUTOLOADING SHOTGUNS	
Maxus	2-5
Silver	24-29
BARRELS	
BPS	38
Gold	30
Silver	30
BPS PUMP SHOTGUNS	32-37
BPS EXTRA BARRELS	38
BT-99 TRAP SHOTGUNS	22-23
CITORI OVER/UNDER SHOTGUNS	6-13
CYNERGY ACCESSORIES	21
CYNERGY OVER/UNDER SHOTGUNS	14-21
GOLD EXTRA BARRELS	30
MAXUS AUTOLOADING SHOTGUNS	2-5
OVER AND UNDER SHOTGUNS	
Citori	6-13
Cynergy	14-21
PUMP SHOTGUNS	
BPS	32-37
SILVER AUTOLOADING SHOTGUNS	24-29
SILVER EXTRA BARRELS	30

Look for the following icons next to select shotguns to alert you to those ideally suited to clay target shooting:



RIFLES ► BEGIN ON PAGE 39

A-BOLT RIFLES	45-51
A-BOLT MAGAZINES	52, 130
AUTOLOADING RIFLES	
BAR	57-62
BOSS-CR ACCESSORY	52, 130
BAR RIFLES	57-62
BAR EXTRA MAGAZINES	61, 131
BAR RECOIL PADS	61
BL-22 RIFLES	66
BLR RIFLES	53-56
BLR MAGAZINES	56, 131
BLR SCOUT MOUNT	55, 128
BUCK MARK RIFLES	68-69
CUSTOM SHOP	78-80
CENTERFIRE RIFLES	
A-Bolt	45-51
BAR	57-62
BLR	53-56
X-Bolt	39-44
LEVER-ACTION RIFLES	
BL-22	66
BLR	53-56
MAGAZINES	
A-Bolt	52, 130
BAR	61, 131
BLR	56, 131
T-Bolt Double Helix	64, 131
X-Bolt	40, 129
MOUNTS	
BLR Takedown Scout Style Scope Mount	55, 128
RECOIL PADS	
BAR	61
RIMFIRE RIFLES	
BL-22	66
Buck Mark	68-69
SA-22	67
T-Bolt	63-65
SA-22 RIFLES	67
T-BOLT RIFLES	63-65
T-BOLT DOUBLE HELIX MAGAZINES	64, 131
X-BOLT RIFLES	39-44

X-BOLT EXTRA MAGAZINES 40, 129

PISTOLS ► BEGIN ON PAGE 70

BUCK MARK	70-74
BUCK MARK MAGAZINES	70, 131
HI POWER	75-77
HI POWER 75TH ANNIVERSARY	75
HI POWER MAGAZINES	77, 131

SAFES ► BEGIN ON PAGE 81

ACCESSORY/OPTION INFORMATION	
Factory-Installed Accessories	105
Game Scenes	102
Heritage Graphics	101
Lock Options	106
User-Installed Accessories	104
FEATURE INFORMATION	
Competitive Comparison	85
Feature Guide	82
Pry and Fire Resistance	84
Storage Solutions/Interiors	86-87
Understanding Safe Features	83

SAFES: PREMIUM

Gold Series	90-91
Medallion Series	92-93
Platinum Plus Series	88-89
Silver Series	94-95

SAFES: VALUE

Bronze Series	96
TheftGard	97

SAFES: SPECIALTY

Compact Series	102
Heritage Graphics	101
Security Door	103
Select Series	100
Tactical Series	98-99
Universal Vault Door	103

SUPPORTING INFORMATION

Warranty	106
----------	-----

GUN CASES ► BEGIN ON PAGE 107

BEAR RIVER FLOATER CASES	115
FITTED PRESENTATION CASES	
Canvas Over/Under	110
Crazy Horse Distressed Leather	111
High Grade Canvas/Crazy Horse Leather	110
John M. Browning Signature	111
Leather/Canvas Series	109
Leather/Canvas Motor Case	109
Santa Fe Waxed Canvas	110
Sporter	109
Traditional	108
Wild Boar	107
FLEXIBLE CASES	
Bear River Floater	115
Flex Foam Buck Mark Pistol/Cimmaron	113
Plainsman	113
Ridge	114
Sheridan/Santa Fe	114
Talon	115
Wild Boar	115
GUN SLIPS, Plainsman	113
GUN SOCKS	115
MOLDED CASES	
Mirage	111
Bruiser	112
TALON ALUMINUM CASES	112

GUN ACCESSORIES ► BEGIN ON PAGE 116

BUCKMARK DECALS	139
BUCK MARK PISTOL ACCESSORIES	137
CARTRIDGE CASES	123
CHOKE TUBES	
Flush Tubes	124
Extended Tubes	125-126
Specialty Tubes	127
Wrenches	124-127
CHOKE TUBE CASES	127
CLEANING ACCESSORIES	136
COMBO PACKS: Hunter's and Rifleman's Pack	138
HEARING PROTECTION	132-133
MAGAZINES	129-131
SCOPE RINGS AND BASES	128-129

BAGS	
Shooting	116-117
Hunting	118-119
SHOOTING GLASSES	134
SIGHTS	135
SLINGS	
Synthetic Slings	120-121
Leather Slings	122-123
SNAP CAPS	127

KNIVES ► BEGIN ON PAGE 140

CAMPING KNIVES	
Backcountry Camp Knife	155
Campmate Knife	158
Camp Saws	158
COLLECTIBLE KNIVES	
Backtrack Folders	152
Crowell/Barker Competition	155
Presentation Lockback	156
Scrimshaw	142
Whitetail Legacy	141
HUNTING AND FISHING KNIVES	
Big Game Series	147
Big Game Stag	147
Browning 111 Folders	152
Escalade	144
Extreme Mountain Hunters	148
Hard Core Hunter Combos	143
Kodiak FDT	151
Lil' Bit	149
Micarta Big Game Series	146
Obsession Hunting	151
Outdoorsman Fillet	145
Packer	150
Woodsmen Bird and Trout	145
KITCHEN KNIVES	
Gaucho Knife	157
Outdoorsman Steak Knives	157
Outdoorsman Kitchen Cutlery Set	157

POCKET KNIVES

Aztec Knife	156
Backdraft Assisted Opening	142
Chinook	156
Classic Folders	153
Eclipse Classic	153
Mountain Ti	154
Prism	154
Silvertip Folders	146

LIGHTS ► BEGIN ON PAGE 159

ACCESSORIES	171-172
FLASHLIGHTS	
Alpha and Alpha Max	162
Black Ice	166
Catalyst	163
Hi Power	160
Hunt Master	163
MicroBlast	164
Pro Hunter	165
Spitfire	165
Tactical Hunter	161
TNT	163
Zeta	162
HEADLAMPS/CAPLIGHTS	
Dakota Headlamps	170
MicroBlast Headlamp	164
Night Seeker Cap Lights	167
Night Seeker Pro Cap Light	167
Night Seeker and MicroBlast Knife/Light Combos	168
Nitro Headlamp	162
Phantom Headlamps	170
Renegade Headlamps	169
Summit Headlamps	169
KEYCHAIN LIGHTS	
Black Ice	170
Duck Call Lanyard Light	168
Echo	171
LANTERNS	171
PEN LIGHTS	164

CLOTHING ► BEGINS ON PAGE 173

ADDHEAT	
Extra Battery	189
Hell's Canyon Jacket	193
Power Pack	189

CLOTHING ▶ CONT.

Vehicle Charger Vest	189
XPO Big Game Insulated Parka	190
BLAZE	
Big Country Vest	214
Caps	232
Hell's Canyon Hooded Sweatshirt and Vest	193-194
Safety Vest	214
BIG GAME	
650 Down	205
700 Fill Power Down	178
Blaze	193-194, 214
Dry-Lite	201
Full Curl Wool	206-207
Hell's Canyon	193-195
Highlands II Wool	208-209
TF-300 Fleece	202-203
Transitions Series	175-182
Tri-Vent/Illusion	213
Wasatch	210-212
XPO Big Game	190-192
CAPS AND HATS	
Camo	231-232
Casual	233-234
Felt Hats	234

Safety Wax Fabric	232
233	
DOWN	
650 Down	205
700 Fill Power Down	178, 186
Junior Down Jacket	203
Santa Fe Down Jacket	204
FIELDWEAR	
Illusion	213
Tri-Vent	213
Wasatch	210-212
FOR HER	
Sporter Double Action Shooting Vest	227
Trapper Creek Mesh Back Shooting Gloves	230
XPO Big Game	192
JUNIOR	
Blaze Safety Vest	214
Down Jacket	203
Sporter Double Action Shooting Vest	227
TF-300 Fleece	203
XPO Big Game	192
SHOOTING CLOTHING	
Badger Creek Shirts	229
Ballistic Insulated Shooting Jacket	225
Broken Birds Vest	226
Deluxe Mesh Vest	228
Leather Tac-Pro Gloves	230
Mesh Back Shooting Gloves	230
Mohave S/S NTS Shirts	229
REACTAR Pads and Harnesses	230
Santa Fe Vest	228
Shooting Towel	230

Sporter Double Action Vest	227
SXS Vest	226
Trapper Creek Half Vest	228
Trapper Creek Mesh Gloves	230
SIZING CHART	
	172



TRANSITIONS SERIES

4X Microfleece	177, 185
700 Fill Power Down	178, 186
NTS and Endurance Fleece	176, 184
Escape Windstopper	181
Gore-Tex Paclite	188
Maxus Gore-Tex Jacket	187
Pursuit	180
Quest Gore-Tex	179
Zero Gravity Paclite	182

TRANSITIONS: BASE LAYER

NTS Base Layer	176
Endurance/Comfort Fleece	184

TRANSITIONS: INSULATION LAYER

4X Microfleece	177, 185
700 Fill Power Down	178, 186

TRANSITIONS: PROTECTION LAYER

Escape Windstopper	181
Gore-Tex Paclite	188
Maxus Gore-Tex Jacket	187
Pursuit	180
Quest Gore-Tex	179
Zero Gravity Paclite	182

UPLAND CLOTHING

Cross Country	218
Game Vests/Bags	218, 220-221
Gore-Tex Upland	219
Lyons Hunt Gear	220
Pheasants Forever	215-217
Prairielands Shirts	222-223
Sweatshirts and Sweaters	223-224
Tri-Vent	222

WATERFOWL

650 Down	205
700 Fill Power Down	186
Transitions	183-188
Warm Front	200
Wasatch	210-212
Windcutter Waterfowl	199
Wing-Set Jacket	196
XPO Grand Passage	197-198

WOOL

Full Curl	206-207
Highlands II	208-209

BOOKS ▶ BEGIN ON PAGE 227

ARS MECHANICA	225
JOHN M. BROWNING BIOGRAPHY	225

PRO STAFF ▶ BEGIN ON PAGE 235

OTHER PRODUCTS ▶ BEGIN ON PAGE 237

AIR GUNS	241
ARCHERY	240
AUTOMOTIVE	237
CAMPING	241
CASUAL SPORTSWEAR	237
COOKWARE	239
CUTTING BOARDS	239
EYEWEAR	238
FISHING	240
FOOTWEAR	238
GIFTS	237
HITCHES	239
SPORTING BAGS/TRAVEL GEAR	242
OUTDOOR HEALTH AND SAFETY	242
POLARIS ALL TERRAIN VEHICLES	Inside Back Cover
SOCKS	238



NEW

NEW INDEX FOR 2010

A new alphabetized index in this catalog lets you locate products faster. An alphabetical listing (by end use) of all Browning products is shown on these two pages. In addition, a quick reference index is located at the beginning of each product section (found on the index page noted in colored header bars).

NEW MOSSY OAK® CAMOUFLAGE FOR 2010

Mossy Oak® and Browning are excited to introduce a new camouflage pattern sure to revolutionize outdoor concealment. New Mossy Oak® Break-Up Infinity™ provides true three-dimensional camouflage with depth and realism that will make you virtually disappear in the woods. This camouflage is so new, sample products could not be produced in time to meet the printing deadlines of this catalog. Look for the Infinity logo and color swatch for the guns and gear available in this new pattern.

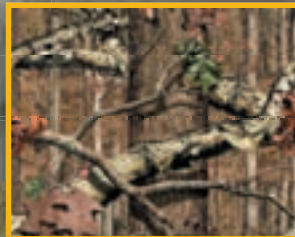

2010 HUNTING AND SHOOTING

MAXUS®

THE BROWNING MAXUS — MAXIMUM RELIABILITY.

The high performance Browning Maxus is the most exciting autoloading shotgun in decades. Innovative technologies join together and deliver up to 18% less felt recoil for greater comfort, 44% less muzzle jump for more accurate follow-up shots, 19% faster bolt speed and 24% faster locktime than the nearest competitor. Other conveniences like the Speed Lock Forearm and TurnKey Magazine Plug further elevate the Maxus. Shoot a Maxus today and you'll agree it is the finest, most reliable 3½" autoloader ever built.

LESS MUZZLE JUMP

Less felt recoil means less muzzle jump and that instantly translates into more birds in your bag. The Power Drive Gas System works perfectly with the Inflex Technology recoil pad to reduce muzzle jump as much as 44% compared to the competition. Feel the performance difference the Maxus makes.

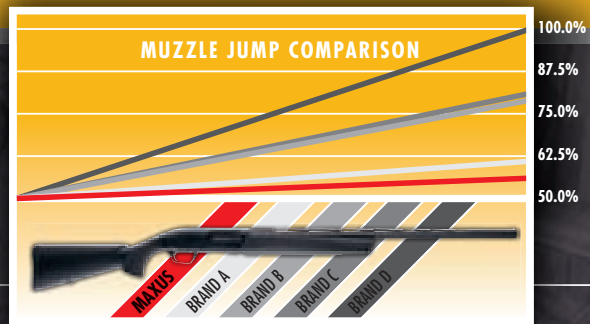

POWER DRIVE GAS SYSTEM

The Power Drive Gas System is the world's finest. Extensive research and testing have resulted in a piston design that's more reliable in all conditions, regardless of heavy or light loads being used. The gas piston features larger exhaust ports that dump gases faster on heavy loads. A patented, enclosed seal design keeps residue out of the action for cleaner operation. The piston has a 20% longer stroke travel to be even more reliable with light loads. Maxus with Power Drive equals outstanding performance.

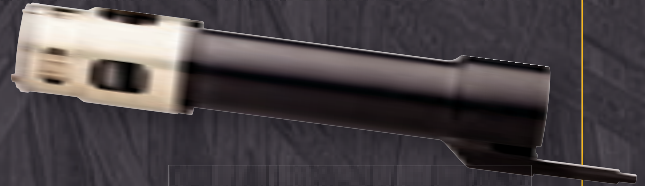

INFLEX TECHNOLOGY RECOIL PAD

The Inflex Technology recoil pad is the softest pad on any autoloader. More than a mass of recoil absorbing material, it has been engineered with directional deflection to pull the comb down and away from your face with every shot for even greater comfort and faster follow-up shooting.

THE SOFTEST SHOOTING AUTOLOADER EVER

Felt recoil is more than just an instantaneous peak force, it is the total energy absorbing experience when you fire a shell. While no recoil reduction system can escape the laws of physics, the Maxus will change your mind about recoil control. The Power Drive Gas System, Inflex Technology recoil pad, Vector Pro™, back-boring and natural Browning balance combine to transfer 18% less total felt recoil force to your shoulder than any autoloader on the market.



SPEED LOCK FOREARM

For the Maxus, our engineers stepped outside the box, then put a target on it. Gone is the traditional bulky screw-on magazine cap, replaced with the patent-pending Speed Lock Forearm. This secure forearm attachment system makes taking down the Maxus for cleaning or storage faster and easier than ever before, and makes attaching or removing a sling a snap.

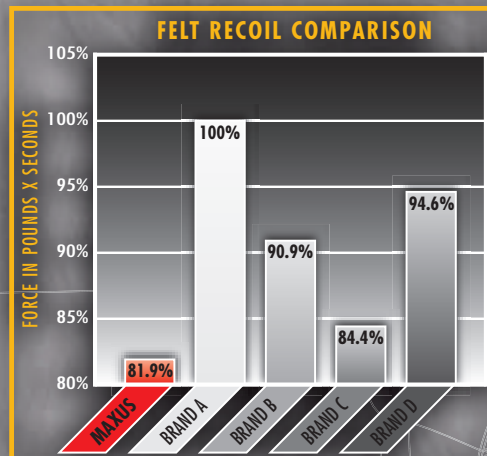

TOTAL BARREL DYNAMICS

INVECTOR-PLUS™ CHOKE SYSTEM

The proven Invector-Plus interchangeable choke tube system works with Vector Pro™ and back-boring to offer consistent, dense shot patterns with just the constriction needed for the shooting situation. The longer choke taper inside an Invector-Plus choke tube produces consistent patterns with more uniform densities and fewer fliers. The superior design of the Invector-Plus system is far more durable than the choke systems found in our competitors' guns, especially when shooting steel shot. Invector-Plus eliminates gases slipping between the choke tube and barrel that could damage the choke tube and the barrel. See page 124 through 127 for a complete listing of choke tubes.

All Browning firearms are shipped with a free locking device to assist in the safe storage of firearms.



The competition's choke tube is grooved and pitted after shooting 500 rounds of steel shot.



Browning's Invector-Plus choke tube is still flawless after 500 rounds of steel.

SHOTGUNS INDEX

10 GAUGE SHOTGUNS: Gold & BPS	31
AUTOLOADING SHOTGUNS	
Maxus	2-5
Silver	24-29
BARRELS	
BPS	38
Gold	30
Silver	30
BPS PUMP SHOTGUNS	32-37
BPS EXTRA BARRELS	38
BT-99 TRAP SHOTGUNS	22-23
CITORI OVER/UNDER SHOTGUNS	6-13
CYNERGY ACCESSORIES	
CYNERGY OVER/UNDER SHOTGUNS	14-21
GOLD EXTRA BARRELS	30
MAXUS AUTOLOADING SHOTGUNS	2-5
OVER AND UNDER SHOTGUNS	
Citori	6-13
Cynergy	14-21
PUMP SHOTGUNS	
BPS	32-37
SILVER AUTOLOADING SHOTGUNS	24-29
SILVER EXTRA BARRELS	30

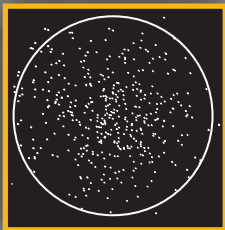

Browning pattern with Back-Bored Technology

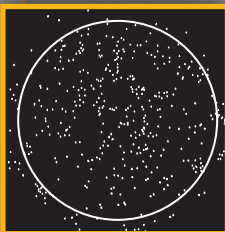

The competitors' pattern without Back-Bored Technology

VECTORPRO™

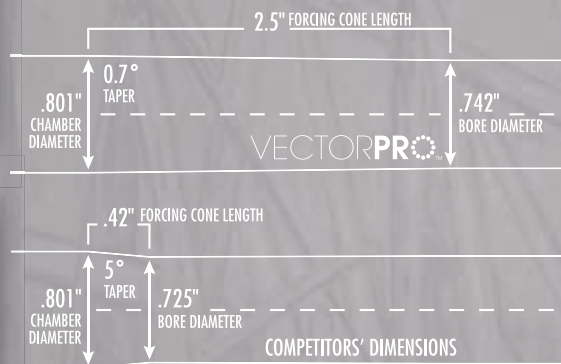

VECTOR PRO™ LENGTHENED FORCING CONE

We were the first manufacturer to recognize the advantages of a back-bored barrel and make it a standard feature on shotguns. Now we have gone a step further with Vector Pro, featuring a lengthened forcing cone that is over 2" longer than other systems. This long, gradual taper minimizes shot deformation and maximizes pattern uniformity, consistency and density. Back-boring increases bore diameter to its maximum specification, reducing friction between the shot cup and the barrel to propel the shot pellets to a higher velocity and reduce felt recoil. Reducing constriction from the forcing cone on the shot column results in fewer deformed pellets for more uniform patterns, and keeps more pellets in the central part of the pattern where they need to be to bag birds and targets. Our back-bore specifications represent the ideal bore diameter. A larger bore diameter can let gases slip by the shot cup, resulting in both reduced pellet velocity and blown patterns. A smaller bore diameter means the forcing cone can deform pellets, leading to poor ballistic performance and uneven, spotty pellet coverage on your target.

STEEL SHOT PERFORMANCE

Our barrels are made to handle the punishment of steel shot. Unlike some manufacturers whose guns face an uncertain future after shooting steel, we have long been at the forefront of dependable steel shot performance and durability. Our barrels meet the strictest material and construction quality standards. The barrel blanks are made from rolled and tempered steel bars and are stress relieved to offer the best mechanical properties. The barrel blanks are then precision drilled, reamed and honed to exacting specifications. Browning Maxus barrels will last.



The forcing cone of the competition is pitted and damaged beyond repair after 500 rounds of steel shot.



After 500 rounds of steel shot, the higher-quality Browning barrel shows no wear.



SPEED LOAD PLUS

Speed Loading has been popular on Browning autoloaders for decades. Our patent-pending feeding system sends the first shell loaded into the magazine directly into the chamber. Now, unloading is just as easy with the Maxus. The Speed Unload feature makes emptying the magazine fast and easy, without having to cycle and chamber every shell with the bolt handle.



MAGAZINE CUT-OFF

The Maxus is equipped with a magazine cut-off that allows you to easily unload the chamber to change loads without cycling a shell from the magazine.

MAXIMUM GRIP

Composite Maxus models combine in-molded textured gripping surfaces and our proven Dura-Touch® Armor Coating for a sure hold and a sleek feel in all climate conditions.

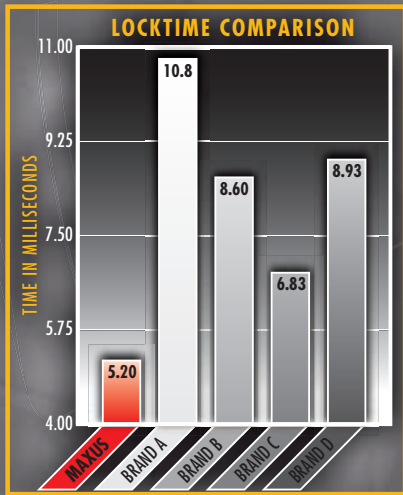

TURNKEY MAGAZINE PLUG

The patent-pending TurnKey Magazine Plug is easily removed in seconds using a vehicle key. Combined with the Speed Lock System, the magazine plug can be removed from the Maxus in mere seconds.

The Lightning Trigger System is the finest ever offered in an autoloading shotgun, designed to offer a smooth, crisp feel with minimal travel. With locktimes averaging .0052 seconds, the Lightning Trigger is 24% faster than the nearest competing autoloader, making every pull perfect. It's also easy to remove for cleaning.

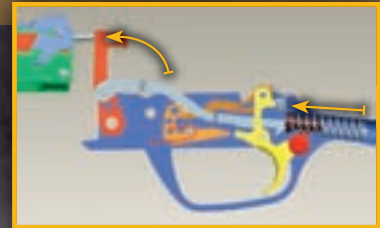

LIGHTNING TRIGGER

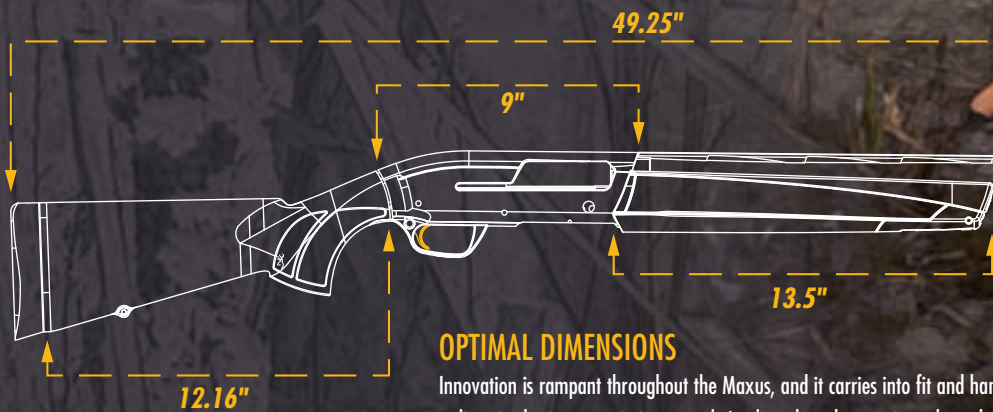

OPTIMAL DIMENSIONS

Innovation is rampant throughout the Maxus, and it carries into fit and handling. The Maxus features a trim forearm and close radius pistol grip to maximize control. A relieved steel magazine tube reduces weight allowing a faster swing while maintaining durability. Drop and cast can be tuned using the included stock shim kit. An externally relieved magazine tube reduces weight and adds strength. A low rib is in line with the top of the receiver and translates into a flat point of impact.

MAXUS®

MAXUS STALKER ▶ GAUGE: 12 | DURA-TOUCH® ARMOR COATING



MAXUS

RECEIVER - Strong, lightweight aluminum alloy
BARREL - Lightweight profile · Flat, ventilated rib
ACTION - Gas-operated autoloader · 3" and 3½" chamber models · Power Drive Gas System reduces recoil and cycles a wide range of loads

STOCK - Composite stock with close radius pistol grip
 · Speed Lock Forearm · Textured gripping surfaces
 · Shim adjustable for length of pull, cast and drop
 · Matte black finish · Dura-Touch® Armor Coating
FEATURES - Vector Pro™ lengthened forcing cone · Three Invector-Plus™ choke tubes · Inflex Technology recoil pad · Ivory front bead sight

GA.	BARREL LENGTH	CODE NUMBER	SUGG. RETAIL	CHOKES INCLUDED	CHAMBER	*AVG. WEIGHT	OVERALL LENGTH	DROP AT COMB	DROP AT HEEL	LENGTH OF PULL	RIB WIDTH
12	28"	011600304	\$1,199.00	F, M, IC	3"	6 lbs. 15 oz.	49¼"	1¾"	2"	14¼"	¼"
12	26"	011600305	1,199.00	F, M, IC	3"	6 lbs. 14 oz.	47¼"	1¾"	2"	14¼"	¼"
12	28"	011600204	1,379.00	F, M, IC	3½"	6 lbs. 15 oz.	49¼"	1¾"	2"	14¼"	¼"
12	26"	011600205	1,379.00	F, M, IC	3½"	6 lbs. 14 oz.	47¼"	1¾"	2"	14¼"	¼"

*NOTE: Weights listed are approximate.



MAXUS MOSSY OAK® DUCK BLIND® ▶ GAUGE: 12 | DURA-TOUCH® ARMOR COATING



MAXUS

RECEIVER - Strong, lightweight aluminum alloy
BARREL - Lightweight profile
 · Flat, ventilated rib
ACTION - Gas-operated autoloader
 · 3" and 3½" chamber models
 · Power Drive Gas System reduces recoil and cycles a wide range of loads

STOCK - Composite stock with close radius pistol grip · Speed Lock Forearm
 · Textured gripping surfaces · Shim adjustable for length of pull, cast and drop · Mossy Oak® Duck Blind® camo finish · Dura-Touch® Armor Coating
FEATURES - Vector Pro™ lengthened forcing cone · Three Invector-Plus™ choke tubes · Inflex Technology recoil pad · Ivory front bead sight

GA.	BARREL LENGTH	CODE NUMBER	SUGG. RETAIL	CHOKES INCLUDED	CHAMBER	*AVG. WEIGHT	OVERALL LENGTH	DROP AT COMB	DROP AT HEEL	LENGTH OF PULL	RIB WIDTH
12	28"	011601304	\$1,339.00	F, M, IC	3"	6 lbs. 15 oz.	49¼"	1¾"	2"	14¼"	¼"
12	26"	011601305	1,339.00	F, M, IC	3"	6 lbs. 14 oz.	47¼"	1¾"	2"	14¼"	¼"
12	28"	011601204	1,509.00	F, M, IC	3½"	6 lbs. 15 oz.	49¼"	1¾"	2"	14¼"	¼"
12	26"	011601205	1,509.00	F, M, IC	3½"	6 lbs. 14 oz.	47¼"	1¾"	2"	14¼"	¼"

*NOTE: Weights listed are approximate.



Citori

BETTER THAN EVER WITH VECTOR PRO™

The Browning Citori is a legend in the firearms industry. These storied over and unders are the epitome of beauty, strength, performance and reliability. For 2010 the Citori receives a performance upgrade with the addition of Vector Pro lengthened forcing cones in every 12 and 20 gauge model. Once again, the Browning Citori elevates the bar a notch higher for the competition to try and match.



TRIPLE TRIGGER SYSTEM

All Sporting Clays, XT and XS Series Citori shotguns come equipped with the Triple Trigger™ System, which fine-tunes the length of pull. Choose between a wide checkered, a narrow smooth and a wide smooth canted trigger shoe.



LOCKING BOLT AND HINGE PIN

The Citori utilizes a transverse-mounted, full-width tapered locking bolt. The tapered locking bolt engages a full-width tapered recess in the rear barrel lugs. The taper allows the bolt to seat deeper over the years. The hinge pin extends from one side of the receiver to the other for maximum strength. It's the reason people say a Citori wears in, not out.

HAMMERS AND HAMMER EJECTORS

The Citori features hammers powered by stout coil-type mainsprings for positive primer ignition. The convenient barrel selector allows you to choose which barrel fires on the first pull of the single trigger, and the second pull fires the remaining barrel. Ejectors are fired by a sharp hammer blow for more positive ejection than the push imparted by competitors' ejectors. The automatic ejectors eject fired shells when the breech is opened and elevate unfired shells for easy removal.



All Browning firearms are shipped with a free locking device to assist in the safe storage of firearms.

TOTAL BARREL DYNAMICS

VECTOR PRO™ LENGTHENED FORCING CONES — NOW ON ALL 12 AND 20 GAUGE CITORI SHOTGUNS

We were the first manufacturer to recognize the advantages of a back-bored barrel and make it a standard feature on shotguns. Now we have gone a step further with Vector Pro, featuring a lengthened forcing cone that is over 2" longer than other systems. This long, gradual taper minimizes shot deformation and maximizes pattern uniformity, consistency and density.

Back-boring increases bore diameter to its maximum specification, reducing friction between the shot cup and the barrel to propel the shot pellets to a higher velocity and reduce felt recoil. Reducing constriction from the forcing cone on the shot column results in fewer deformed pellets for more uniform patterns, and keeps more pellets in the central part of the pattern where they need to be to bag birds and targets. Our back-bore specifications represent the ideal bore diameter. A larger bore diameter can let gases slip by the shot cup, resulting in both reduced pellet velocity and blown patterns. A smaller bore diameter means the forcing cone can deform pellets, leading to poor ballistic performance and uneven, spotty pellet coverage on the target.

VECTORPRO™

INVECTOR™ CHOKE TUBE SYSTEMS

The proven Invector (28 gauge, .410 bore) or Invector-Plus™ (12, 20 gauge) interchangeable choke tube systems come on every Citori shotgun for consistent, dense shot patterns in the constriction needed for the specific shooting situation. The longer choke taper inside an Invector-Plus choke tube works hand-in-hand with lengthened Vector Pro™ forcing cones and original Back-Bored Technology to produce consistent patterns with more uniform densities and fewer fliers. The superior designs of the Invector systems are far more durable than the choke systems found in competitors' guns, especially when shooting steel shot loads. The Invector systems eliminate gases slipping between the choke tube and barrel that could damage the choke tube and the barrel.

CHROME CHAMBERS

To increase durability, all Citori shotguns feature hard chrome-plated chambers that resist the toll that thousands of shells can take on lesser quality guns. Corrosion resistance is also greatly improved.

BACK-BORED TECHNOLOGY

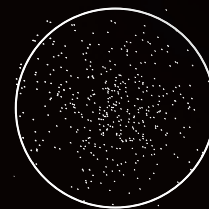

Browning pattern with Back-Bored Technology



The competitors' pattern without Back-Bored Technology

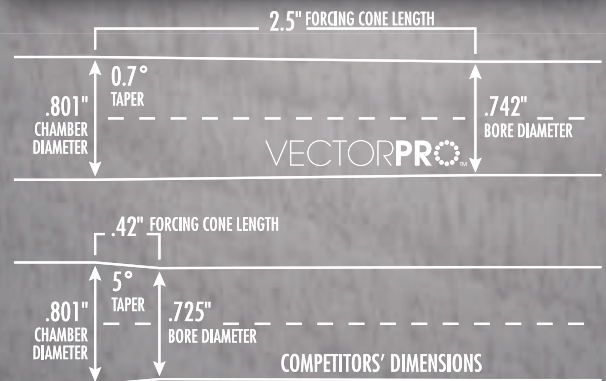

STEEL SHOT PERFORMANCE



The strength of a Browning barrel is legendary, and built to handle the punishment of steel shot. Unlike some manufacturers' barrels whose guns face an uncertain future after shooting steel, we have long been at the forefront of dependable steel shot performance and durability. Our barrels meet the strictest material and construction quality standards. The barrel blanks are made from rolled and tempered steel bars and are stress relieved to offer the best mechanical properties. The barrel blanks are then precision drilled, reamed and honed to exacting specifications. With proper care, Browning Citori barrels will last a lifetime.

CITORI WHITE LIGHTNING ▶ GAUGE: 12, 20 (SHOWN), 28, .410 | GLOSS OIL FINISH

NEW



VECTORPRO™



RECEIVER - Steel · Silver nitride finish · High-relief engraving
 BARREL - Ventilated rib

ACTION - Single selective trigger
 · Hammer ejectors · Top-tang barrel selector/safety
 STOCK - Gloss oil finish Grade II/III walnut
 · Lightning-style stock and forearm
 FEATURES - Vector Pro™ lengthened forcing cones on 12 and 20 · Three Invector-Plus™ choke tubes on 12 and 20 · Three Standard Invector™ on 28 and .410 · Recoil pad on 12 gauge model
 · Ivory front bead sight

	GA.	BARREL LENGTH	CODE NUMBER	SUGG. RETAIL	CHOKES INCLUDED	CHAMBER	*AVG. WEIGHT	OVERALL LENGTH	DROP AT COMB	DROP AT HEEL	LENGTH OF PULL	RIB WIDTH
NEW	12	28"	013462304	\$1,939.00	F, M, IC	3"	8 lbs. 2 oz.	45"	1½"	2½"	14¼"	⅝"
NEW	12	26"	013462305	1,939.00	F, M, IC	3"	8 lbs.	43"	1½"	2½"	14¼"	⅝"
NEW	20	28"	013462604	1,939.00	F, M, IC	3"	6 lbs. 9 oz.	45"	1½"	2⅝"	14¼"	¼"
NEW	20	26"	013462605	1,939.00	F, M, IC	3"	6 lbs. 7 oz.	43"	1½"	2⅝"	14¼"	¼"
NEW	28	28"	013462813	1,999.00	F, M, IC	2¾"	6 lbs. 12 oz.	45"	1½"	2⅝"	14¼"	¼"
NEW	28	26"	013462814	1,999.00	F, M, IC	2¾"	6 lbs. 10 oz.	43"	1½"	2⅝"	14¼"	¼"
NEW	.410	28"	013462913	1,999.00	F, M, IC	3"	6 lbs. 10 oz.	45"	1½"	2⅝"	14¼"	¼"
NEW	.410	26"	013462914	1,999.00	F, M, IC	3"	6 lbs. 8 oz.	43"	1½"	2⅝"	14¼"	¼"

CITORI LIGHTNING ▶ GAUGE: 12, 20 (SHOWN), 28, .410 | GLOSS FINISH

NEW



Citori Lightning, Left

Citori Lightning, Right

RECEIVER - Steel · Blued finish · High-relief engraving
 BARREL - Ventilated rib
 ACTION - Single selective trigger · Hammer ejectors · Top-tang barrel selector/safety
 STOCK - Gloss finish walnut · Lightning-style stock and forearm
 FEATURES - Vector Pro™ lengthened forcing cones on 12 and 20 · Three Invector-Plus™ choke tubes on 12 and 20 · Three Standard Invector™ on 28 and .410 · Recoil pad on 12 gauge model (see Grade IV and VII models on page 13) · Ivory front bead sight

VECTORPRO™



	GA.	BARREL LENGTH	CODE NUMBER	SUGG. RETAIL	CHOKES INCLUDED	CHAMBER	*AVG. WEIGHT	OVERALL LENGTH	DROP AT COMB	DROP AT HEEL	LENGTH OF PULL	RIB WIDTH
NEW	12	28"	013461304	\$1,869.00	F, M, IC	3"	8 lbs. 2 oz.	45"	1½"	2½"	14¼"	⅝"
NEW	12	26"	013461305	1,869.00	F, M, IC	3"	8 lbs.	43"	1½"	2½"	14¼"	⅝"
NEW	20	28"	013461604	1,869.00	F, M, IC	3"	6 lbs. 9 oz.	45"	1½"	2⅝"	14¼"	¼"
NEW	20	26"	013461605	1,869.00	F, M, IC	3"	6 lbs. 7 oz.	43"	1½"	2⅝"	14¼"	¼"
NEW	28	28"	013461813	1,939.00	F, M, IC	2¾"	6 lbs. 12 oz.	45"	1½"	2⅝"	14¼"	¼"
NEW	28	26"	013461814	1,939.00	F, M, IC	2¾"	6 lbs. 10 oz.	43"	1½"	2⅝"	14¼"	¼"
NEW	.410	28"	013461913	1,939.00	F, M, IC	3"	6 lbs. 10 oz.	45"	1½"	2⅝"	14¼"	¼"
NEW	.410	26"	013461914	1,939.00	F, M, IC	3"	6 lbs. 8 oz.	43"	1½"	2⅝"	14¼"	¼"

*NOTE: Weights listed are approximate.

CITORI 625 FEATHER ▶ GAUGE: 12 (SHOWN), 20, 28, .410 | GLOSS OIL FINISH



VECTORPRO



RECEIVER - Lightweight alloy with steel breech face and hinge pin · High-relief engraving
BARREL - Lightweight profile · Ventilated rib
ACTION - Single selective trigger · Hammer ejectors · Top-tang barrel selector/safety

STOCK - Gloss oil finish Grade II/III walnut stock with close radius pistol grip · Schnabel forearm
FEATURES - Vector Pro™ lengthened forcing cones on 12 and 20 · Three Invector-Plus™ choke tubes on 12 and 20 · Three Standard Invector™ on 28 and .410 · Recoil pad on 12 gauge model · Ivory front bead sight



Citori 625 Feather 12 Gauge, Left

Citori 625 Feather 12 Gauge, Right

Citori 625 Feather Small Gauge, Left

Citori 625 Feather Small Gauge, Right

GA.	BARREL LENGTH	CODE NUMBER	SUGG. RETAIL	CHOKES INCLUDED	CHAMBER	*AVG. WEIGHT	OVERALL LENGTH	DROP AT COMB	DROP AT HEEL	LENGTH OF PULL	RIB WIDTH
12	28"	013427304	\$2,659.00	F, M, IC	3"	7 lbs.	45"	1½"	2½"	14¼"	⅝"
12	26"	013427305	2,659.00	F, M, IC	3"	6 lbs. 14 oz.	43"	1½"	2½"	14¼"	⅝"
20	28"	013427604	2,659.00	F, M, IC	3"	5 lbs. 8 oz.	45"	1½"	2¾"	14¼"	¼"
20	26"	013427605	2,659.00	F, M, IC	3"	5 lbs. 6 oz.	43"	1½"	2¾"	14¼"	¼"
28	28"	013427813	2,679.00	F, M, IC	2¾"	5 lbs. 11 oz.	45"	1½"	2¾"	14¼"	¼"
28	26"	013427814	2,679.00	F, M, IC	2¾"	5 lbs. 9 oz.	43"	1½"	2¾"	14¼"	¼"
.410	28"	013427913	2,679.00	F, M, IC	3"	5 lbs. 13 oz.	45"	1½"	2¾"	14¼"	¼"
.410	26"	013427914	2,679.00	F, M, IC	3"	5 lbs. 11 oz.	43"	1½"	2¾"	14¼"	¼"

*NOTE: Weights listed are approximate.

CITORI 625 FIELD ▶ GAUGE: 12 (SHOWN), 20, 28, .410 | GLOSS OIL FINISH

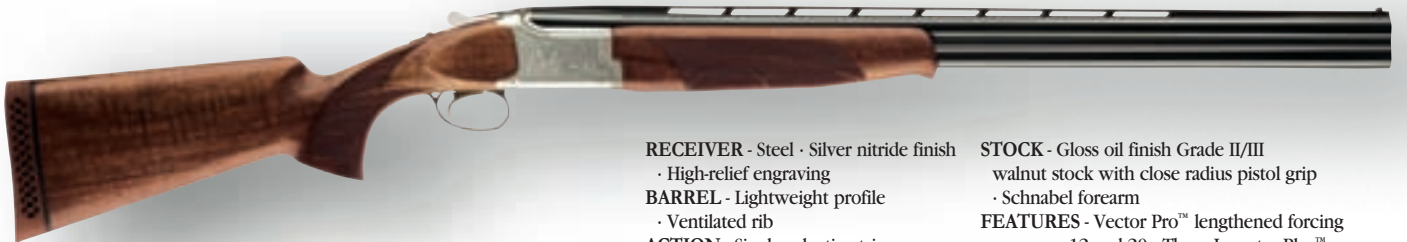

VECTORPRO



RECEIVER - Steel · Silver nitride finish · High-relief engraving
BARREL - Lightweight profile · Ventilated rib
ACTION - Single selective trigger · Hammer ejectors · Top-tang barrel selector/safety

STOCK - Gloss oil finish Grade II/III walnut stock with close radius pistol grip · Schnabel forearm
FEATURES - Vector Pro™ lengthened forcing cones on 12 and 20 · Three Invector-Plus™ choke tubes on 12 and 20 · Three Standard Invector™ on 28 and .410 · Recoil pad on 12 gauge model · Ivory front bead sight



Citori 625 Field 12 Gauge, Left

Citori 625 Field 12 Gauge, Right

Citori 625 Field Small Gauge, Left

Citori 625 Field Small Gauge, Right

GA.	BARREL LENGTH	CODE NUMBER	SUGG. RETAIL	CHOKES INCLUDED	CHAMBER	*AVG. WEIGHT	OVERALL LENGTH	DROP AT COMB	DROP AT HEEL	LENGTH OF PULL	RIB WIDTH
12	28"	013356304	\$2,469.00	F, M, IC	3"	7 lbs. 14 oz.	45"	1½"	2½"	14¼"	⅝"
12	26"	013356305	2,469.00	F, M, IC	3"	7 lbs. 12 oz.	43"	1½"	2½"	14¼"	⅝"
20	28"	013356604	2,469.00	F, M, IC	3"	6 lbs. 9 oz.	45"	1½"	2¾"	14¼"	¼"
20	26"	013356605	2,469.00	F, M, IC	3"	6 lbs. 7 oz.	43"	1½"	2¾"	14¼"	¼"
28	28"	013356813	2,499.00	F, M, IC	2¾"	6 lbs. 13 oz.	45"	1½"	2¾"	14¼"	¼"
28	26"	013356814	2,499.00	F, M, IC	2¾"	6 lbs. 11 oz.	43"	1½"	2¾"	14¼"	¼"
.410	28"	013356913	2,499.00	F, M, IC	3"	6 lbs. 14 oz.	45"	1½"	2¾"	14¼"	¼"
.410	26"	013356914	2,499.00	F, M, IC	3"	6 lbs. 12 oz.	43"	1½"	2¾"	14¼"	¼"

*NOTE: Weights listed are approximate.

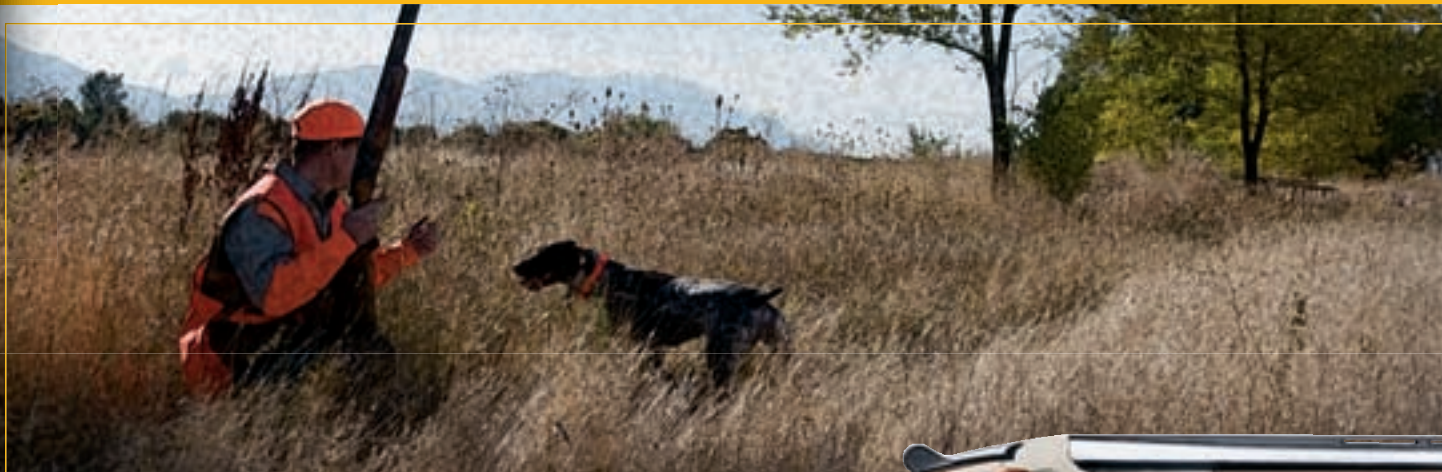

CITORI SUPERLIGHT FEATHER ▶ GAUGE: 12, 20 (SHOWN) | GLOSS FINISH



VECTORPRO™



RECEIVER - Lightweight alloy with steel breech face and hinge pin
 · High-relief engraving

BARREL - Ventilated rib

ACTION - Single selective trigger
 · Hammer ejectors · Top-tang barrel selector/safety

STOCK - Gloss finish walnut
 · English-style straight grip stock
 · Schnabel forearm

FEATURES - Vector Pro™ lengthened forcing cones on 12 and 20 · Three Invector-Plus™ choke tubes · Ivory front bead sight

CITORI LIGHTNING FEATHER COMBO ▶ GAUGE: 20, 28 | GLOSS FINISH

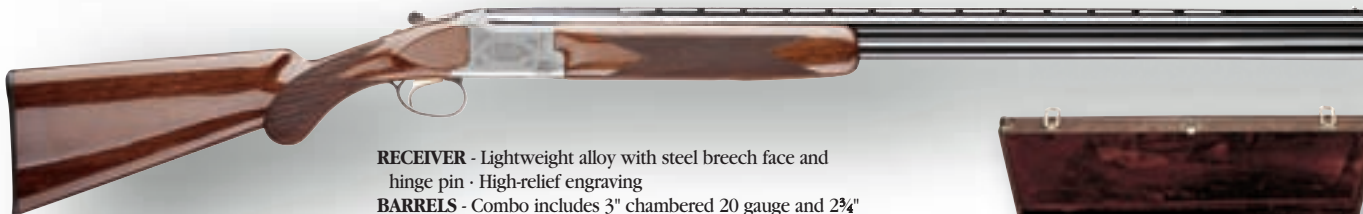

VECTORPRO™



RECEIVER - Lightweight alloy with steel breech face and hinge pin · High-relief engraving

BARRELS - Combo includes 3" chambered 20 gauge and 2¾" chambered 28 gauge barrels in 27" length · Ventilated rib

ACTION - Single selective trigger · Hammer ejectors
 · Top-tang barrel selector/safety

STOCK - Gloss finish walnut · Lightning-style stock and forearm

FEATURES - Vector Pro™ lengthened forcing cones on 20 gauge barrels
 · Three Invector-Plus™ 20 gauge choke tubes · Three Standard Invector™ 28 gauge choke tubes · Ivory front bead sight · Fitted luggage case included

CITORI 625 SPORTING ▶ GAUGE: 12 (SHOWN), 20, 28, .410 | GLOSS OIL FINISH

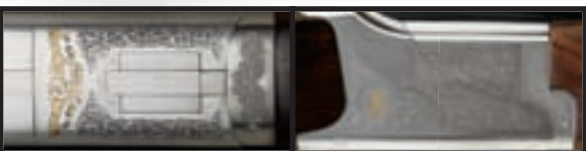

VECTORPRO™



RECEIVER - Steel · Silver nitride finish · High-relief engraving with gold embellishment

BARREL - Ventilated top and side rib
 · Tapered, floating top rib · Ported on 12 and 20

ACTION - Single selective trigger
 · Hammer ejectors · Top-tang barrel selector/safety

STOCK - Gloss oil finish Grade III/IV walnut stock with close radius pistol grip and right-hand palm swell
 · Schnabel forearm

FEATURES - Vector Pro™ lengthened forcing cones on 12 and 20 · Five Diamond Grade extended Invector-Plus™ choke tubes on 12 and 20 · Standard Invector™ on 28 and .410 · Sporting recoil pad · Triple Trigger™ System · HiViz® Pro-Comp fiber-optic sight

Citori 625 Sporting, Bottom

Citori 625 Sporting, Right

CITORI XS SPECIAL WITH LOW POST RIB AND ADJUSTABLE COMB ▶ GAUGE: 12 | SATIN FINISH



VECTORPRO



RECEIVER - Steel · Silver nitride finish · Gold accented, high-relief XS Special engraving
BARREL - Lightweight profile · Ventilated top and side ribs · Tapered, floating low-post top rib · Ported
ACTION - Single selective trigger · Hammer ejectors · Top-tang barrel selector/safety

STOCK - Satin finish walnut stock with right-hand palm swell · Adjustable comb · Semi-beavertail forearm with finger grooves · Ideal for skeet and sporting clays
FEATURES - Vector Pro™ lengthened forcing cones · Five Invector-Plus™ Midas™ Grade choke tubes · Triple Trigger™ System · HiViz® Pro-Comp fiber-optic sight

ENGINEERED FOR YEARS OF PERFORMANCE.

High-quality fit and finish make the Citori one of the most durable, long-lasting guns available. When you open the breech of a Citori, you will experience the smoothness that comes from carefully machined, polished and hand-fit components. A Citori can best be described as elegantly rugged, an over and under shotgun you will be proud to own.

CITORI XS SPECIAL WITH HIGH POST RIB AND ADJUSTABLE COMB ▶ GAUGE: 12 | SATIN FINISH



VECTORPRO



RECEIVER - Steel · Silver nitride finish · Gold accented, high-relief XS Special engraving
BARREL - Lightweight profile · Ventilated top and side ribs · Tapered, floating high-post top rib · Ported
ACTION - Single selective trigger · Hammer ejectors · Top-tang barrel selector/safety

STOCK - Satin finish walnut stock with right-hand palm swell · Adjustable comb · Semi-beavertail forearm with finger grooves · Ideal for skeet and sporting clays
FEATURES - Vector Pro™ lengthened forcing cones · Five Invector-Plus™ Midas™ Grade choke tubes · Triple Trigger™ System · HiViz® Pro-Comp fiber-optic sight

	GA.	BARREL LENGTH	CODE NUMBER	SUGG. RETAIL	CHOKES INCLUDED	CHAMBER	*AVG. WEIGHT	OVERALL LENGTH	DROP AT COMB	DROP AT HEEL	LENGTH OF PULL	RIB WIDTH (TAPERED)
CITORI SUPERLIGHT FEATHER												
	12	26"	013055405	\$2,359.00	F, M, IC	2¾"	6 lbs. 4 oz.	43"	1⅝"	2½"	14¼"	¼"
	20	26"	013055705	2,359.00	F, M, IC	2¾"	5 lbs. 11 oz.	43"	1½"	2⅝"	14¼"	⅞"
CITORI LIGHTNING FEATHER COMBO												
	20 28	27"	013064735	\$3,699.00	F, M, IC	3" & 2¾"	6 lbs. 3 oz.	44"	1½"	2⅝"	14¼"	¼"
CITORI 625 SPORTING (SHOWN)												
	12	32"	013355426	\$3,519.00	F, IM, M, IC, SK	2¾"	8 lbs. 2 oz.	50½"	1⅞"	2⅝"	14¾"	(⅝" - 7/16")
	12	30"	013355427	3,519.00	F, IM, M, IC, SK	2¾"	8 lbs.	48½"	1⅞"	2⅝"	14¾"	(⅝" - 7/16")
	12	28"	013355428	3,519.00	F, IM, M, IC, SK	2¾"	7 lbs. 14 oz.	46½"	1⅞"	2⅝"	14¾"	(⅝" - 7/16")
	20	32"	013355726	3,519.00	F, IM, M, IC, SK	2¾"	7 lbs. 3 oz.	49½"	1⅞"	2⅝"	14¾"	⅝"
	20	30"	013355727	3,519.00	F, IM, M, IC, SK	2¾"	7 lbs. 1 oz.	47½"	1⅞"	2⅝"	14¾"	⅝"
	20	28"	013355728	3,519.00	F, IM, M, IC, SK	2¾"	6 lbs. 15 oz.	45½"	1⅞"	2⅝"	14¾"	⅝"
	28	32"	013355811	3,539.00	F, IM, M, IC, SK	2¾"	7 lbs. 6 oz.	49½"	1⅞"	2⅝"	14¾"	⅝"
	28	30"	013355812	3,539.00	F, IM, M, IC, SK	2¾"	7 lbs. 4 oz.	47½"	1⅞"	2⅝"	14¾"	⅝"
	28	28"	013355813	3,539.00	F, IM, M, IC, SK	2¾"	7 lbs. 2 oz.	45½"	1⅞"	2⅝"	14¾"	⅝"
	.410	32"	013355911	3,539.00	F, IM, M, IC, SK	3"	7 lbs. 7 oz.	49½"	1⅞"	2⅝"	14¾"	⅝"
	.410	30"	013355912	3,539.00	F, IM, M, IC, SK	3"	7 lbs. 5 oz.	47½"	1⅞"	2⅝"	14¾"	⅝"
	.410	28"	013355913	3,539.00	F, IM, M, IC, SK	3"	7 lbs. 3 oz.	45½"	1⅞"	2⅝"	14¾"	⅝"
CITORI 625 SPORTING WITH ADJUSTABLE COMB												
	12	32"	013399426	\$3,839.00	F, IM, M, IC, SK	2¾"	8 lbs. 9 oz.	50⅝"	1¾" Adj.	2½" Adj.	14¾"	(⅝" - 7/16")
	12	30"	013399427	3,839.00	F, IM, M, IC, SK	2¾"	8 lbs. 7 oz.	48⅝"	1¾" Adj.	2½" Adj.	14¾"	(⅝" - 7/16")
	12	28"	013399428	3,839.00	F, IM, M, IC, SK	2¾"	8 lbs. 5 oz.	46⅝"	1¾" Adj.	2½" Adj.	14¾"	(⅝" - 7/16")
CITORI XS SPECIAL WITH LOW POST RIB AND ADJUSTABLE COMB												
	12	32"	013128426	\$3,349.00	IM, M, IC, SK, C	2¾"	8 lbs. 12 oz.	49¾"	1⅞" Adj.	1⅞" Adj.	14¾"	(⅝" - 7/16")
	12	30"	013128427	3,349.00	IM, M, IC, SK, C	2¾"	8 lbs. 10 oz.	47¾"	1⅞" Adj.	1⅞" Adj.	14¾"	(⅝" - 7/16")
CITORI XS SPECIAL WITH HIGH POST RIB AND ADJUSTABLE COMB												
	12	32"	013175426	\$3,349.00	IM, M, IC, SK, C	2¾"	8 lbs. 12 oz.	49¾"	1⅞" Adj.	1⅞" Adj.	14¾"	(⅝" - 7/16")
	12	30"	013175427	3,349.00	IM, M, IC, SK, C	2¾"	8 lbs. 10 oz.	47¾"	1⅞" Adj.	1⅞" Adj.	14¾"	(⅝" - 7/16")

*NOTE: Weights listed are approximate.

CITORI XS SKEET ▶ GAUGE: 12 (SHOWN), 20 | SATIN FINISH



RECEIVER - Steel · Silver nitride finish
· Gold accented, high-relief engraving
BARREL - Lightweight profile · Ventilated top and side ribs · Tapered, floating high-post top rib · Ported
ACTION - Single selective trigger
· Hammer ejectors · Top-tang barrel selector/safety

STOCK - Satin finish Grade III/IV walnut stock with right-hand palm swell · Semi-beavertail forearm with finger grooves
FEATURES - Vector Pro™ lengthened forcing cones · Three Invector-Plus™ choke tubes · Triple Trigger™ System · HiViz® Pro-Comp fiber-optic sight · Adjustable comb optional

VECTORPRO



BACK-BORED TECHNOLOGY

CITORI XT TRAP GOLD WITH ADJUSTABLE COMB ▶ GAUGE: 12 | GLOSS FINISH

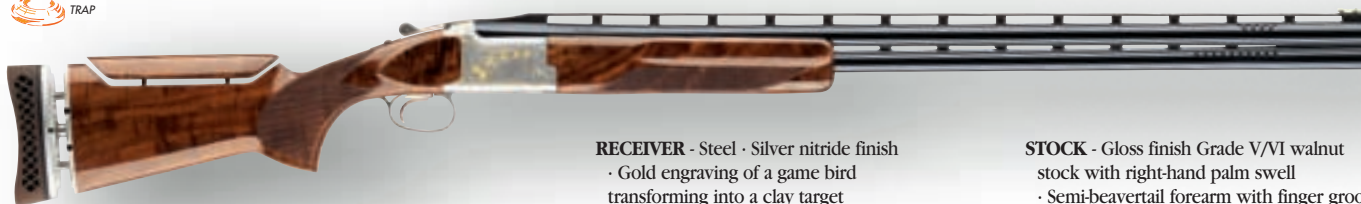

RECEIVER - Steel · Silver nitride finish
· Gold engraving of a game bird transforming into a clay target
BARREL - Ventilated top and side ribs · Tapered, floating high-post top rib · Ported
ACTION - Single selective trigger · Hammer ejectors · Top-tang barrel selector/safety

STOCK - Gloss finish Grade V/VI walnut stock with right-hand palm swell · Semi-beavertail forearm with finger grooves
FEATURES - Vector Pro™ lengthened forcing cones · Three Invector-Plus™ choke tubes · Triple Trigger™ System · HiViz® Pro-Comp sight · Adjustable straight comb · Adjustable GraCoil® recoil reduction system

VECTORPRO



BACK-BORED TECHNOLOGY

CITORI XT TRAP ▶ GAUGE: 12 | GLOSS FINISH



RECEIVER - Steel · Silver nitride finish
· Gold accented, high-relief engraving
BARREL - Ventilated top and side ribs · Tapered, floating high-post top rib · Ported
ACTION - Single selective trigger · Hammer ejectors · Top-tang barrel selector/safety

STOCK - Gloss finish Grade III/IV walnut stock with right-hand palm swell · Semi-beavertail forearm with finger grooves
FEATURES - Vector Pro™ lengthened forcing cones · Three Invector-Plus™ choke tubes · Triple Trigger™ System · HiViz® Pro-Comp sight · Adjustable straight comb optional

VECTORPRO



BACK-BORED TECHNOLOGY

GA.	BARREL LENGTH	CODE NUMBER	SUGG. RETAIL	CHOKES INCLUDED	CHAMBER	*AVG. WEIGHT	OVERALL LENGTH	DROP AT COMB	DROP AT HEEL	LENGTH OF PULL	RIB WIDTH (TAPERED)
CITORI XS SKEET											
12	30"	013065427	\$2,989.00	SK, SK, IC	2¾"	7 lbs. 15 oz.	47½"	1¾"	1¾"	14¾"	¾"
12	28"	013065428	2,989.00	SK, SK, IC	2¾"	7 lbs. 13 oz.	45½"	1¾"	1¾"	14¾"	¾"
20	30"	013065727	2,989.00	SK, SK, IC	2¾"	7 lbs. 4 oz.	47½"	1¾"	1¾"	14¾"	¾"
20	28"	013065728	2,989.00	SK, SK, IC	2¾"	7 lbs. 2 oz.	45½"	1¾"	1¾"	14¾"	¾"
CITORI XS SKEET WITH ADJUSTABLE COMB (SHOWN)											
12	30"	013066427	\$3,319.00	SK, SK, IC	2¾"	8 lbs. 4 oz.	47½"	1⅞" Adj.	1⅞" Adj.	14¾"	¾"
12	28"	013066428	3,319.00	SK, SK, IC	2¾"	8 lbs. 2 oz.	45½"	1⅞" Adj.	1⅞" Adj.	14¾"	¾"
20	30"	013066727	3,319.00	SK, SK, IC	2¾"	7 lbs. 9 oz.	47½"	1⅞" Adj.	1⅞" Adj.	14¾"	¾"
20	28"	013066728	3,319.00	SK, SK, IC	2¾"	7 lbs. 7 oz.	45½"	1⅞" Adj.	1⅞" Adj.	14¾"	¾"
CITORI XT TRAP GOLD WITH ADJUSTABLE COMB											
12	32"	013228426	\$5,179.00	F, F, IM	2¾"	9 lbs. 2 oz.	49"	1¼½" Adj.	1¼½" Adj.	14¾"	(¼" - ¾")
12	30"	013228427	5,179.00	F, F, IM	2¾"	9 lbs.	47"	1¼½" Adj.	1¼½" Adj.	14¾"	(¼" - ¾")
CITORI XT TRAP (SHOWN)											
12	32"	013058426	\$2,789.00	F, F, IM	2¾"	8 lbs. 8 oz.	49"	1⅞"	2"	14¾"	(¼" - ¾")
12	30"	013058427	2,789.00	F, F, IM	2¾"	8 lbs. 6 oz.	47"	1⅞"	2"	14¾"	(¼" - ¾")
CITORI XT TRAP WITH ADJUSTABLE COMB											
12	32"	013057426	\$3,139.00	F, F, IM	2¾"	8 lbs. 13 oz.	49"	1¼½" Adj.	1¼½" Adj.	14¾"	(¼" - ¾")
12	30"	013057427	3,139.00	F, F, IM	2¾"	8 lbs. 11 oz.	47"	1¼½" Adj.	1¼½" Adj.	14¾"	(¼" - ¾")

*NOTE: Weights listed are approximate.

CITORI GRADE IV LIGHTNING ▶ GAUGE: 12 (SHOWN), 20, 28, .410 | GLOSS FINISH



RECEIVER - Steel · Grayed finish · Full coverage high-relief engraving includes the trigger guard and tang screws (12 gauge models illustrate pheasants on the right, mallards on the left. 20, 28 gauge and .410 bore models feature quail and grouse.)
BARREL - Ventilated rib

ACTION - Single selective trigger
 · Hammer ejectors · Top-tang barrel selector/safety
STOCK - Gloss finish Grade III/IV walnut
 · Lightning-style stock and forearm
FEATURES - Vector Pro™ lengthened forcing cones on 12 and 20 · Three Invector-Plus™ choke tubes on 12 and 20 · Three Standard Invector™ on 28 and .410 · Recoil pad on 12 gauge model · Ivory front bead sight



Grade IV 12 Gauge, Left

Grade IV 12 Gauge, Right

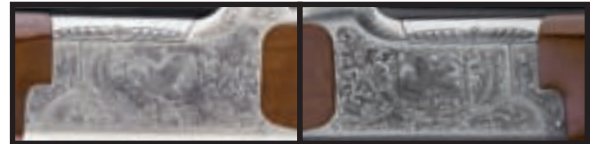

Grade IV 20 & 28 Ga., .410, Left

Grade IV 20 & 28 Ga., .410, Right

CITORI GRADE VII LIGHTNING ▶ GAUGE: 12, 20 (SHOWN), 28, .410 | GLOSS FINISH



RECEIVER - Steel · Blued and Grayed finishes available · Full coverage high-relief engraving is gold enhanced and includes the trigger guard, top-tang, forearm takedown lever and bracket (12 gauge models depict two flushing ringnecks and a pointer on the right side and three mallard drakes on the left side. 20, 28 gauge and .410 bore models feature quail and grouse.)

BARREL - Ventilated rib
ACTION - Single selective trigger
 · Hammer ejectors · Top-tang barrel selector/safety
STOCK - Gloss finish Grade V/VI walnut
 · Lightning-style stock and forearm
FEATURES - Vector Pro™ lengthened forcing cones on 12 and 20 · Three Invector-Plus™ choke tubes on 12 and 20 · Three Standard Invector™ on 28 and .410 · Recoil pad on 12 gauge model · Ivory front bead sight



Grade VII 12 Gauge, Grayed (L)

Grade VII 12 Gauge, Grayed (R)



Gr. VII 20 & 28 Ga., .410, Grayed (L)

Gr. VII 20 & 28 Ga., .410, Grayed (R)

	GA.	BARREL LENGTH	CODE NUMBER	SUGG. RETAIL	CHOKES INCLUDED	CHAMBER	*AVG. WEIGHT	OVERALL LENGTH	DROP AT COMB	DROP AT HEEL	LENGTH OF PULL	RIB WIDTH	
CITORI GRADE IV LIGHTNING													
	12	28"	013229304	\$3,179.00	F, M, IC	3"	8 lbs. 3 oz.	45"	1½"	2½"	14¾"	⅝"	
	12	26"	013229305	3,179.00	F, M, IC	3"	8 lbs. 1 oz.	43"	1½"	2½"	14¾"	⅝"	
	20	28"	013229604	3,179.00	F, M, IC	3"	6 lbs. 12 oz.	45"	1½"	2⅝"	14¾"	¼"	
	20	26"	013229605	3,179.00	F, M, IC	3"	6 lbs. 10 oz.	43"	1½"	2⅝"	14¾"	¼"	
	28	28"	013229813	3,239.00	F, M, IC	2¾"	6 lbs. 10 oz.	45"	1½"	2⅝"	14¾"	¼"	
	28	26"	013229814	3,239.00	F, M, IC	2¾"	6 lbs. 8 oz.	43"	1½"	2⅝"	14¾"	¼"	
	.410	28"	013229913	3,239.00	F, M, IC	3"	6 lbs. 10 oz.	45"	1½"	2⅝"	14¾"	¼"	
	.410	26"	013229914	3,239.00	F, M, IC	3"	6 lbs. 8 oz.	43"	1½"	2⅝"	14¾"	¼"	
CITORI GRADE VII LIGHTNING													
	Blued	12	28"	013302304	\$5,039.00	F, M, IC	3"	8 lbs. 3 oz.	45"	1½"	2½"	14¾"	⅝"
	Blued	12	26"	013302305	5,039.00	F, M, IC	3"	8 lbs. 1 oz.	43"	1½"	2½"	14¾"	⅝"
	Grayed	12	28"	013308304	5,039.00	F, M, IC	3"	8 lbs. 3 oz.	45"	1½"	2½"	14¾"	⅝"
	Grayed	12	26"	013308305	5,039.00	F, M, IC	3"	8 lbs. 1 oz.	43"	1½"	2½"	14¾"	⅝"
	Blued	20	28"	013302604	5,039.00	F, M, IC	3"	6 lbs. 12 oz.	45"	1½"	2⅝"	14¾"	¼"
	Blued	20	26"	013302605	5,039.00	F, M, IC	3"	6 lbs. 10 oz.	43"	1½"	2⅝"	14¾"	¼"
	Grayed	20	28"	013308604	5,039.00	F, M, IC	3"	6 lbs. 12 oz.	45"	1½"	2⅝"	14¾"	¼"
	Grayed	20	26"	013308605	5,039.00	F, M, IC	3"	6 lbs. 10 oz.	43"	1½"	2⅝"	14¾"	¼"
	Blued	28	28"	013302813	5,109.00	F, M, IC	2¾"	6 lbs. 9 oz.	45"	1½"	2⅝"	14¾"	¼"
	Blued	28	26"	013302814	5,109.00	F, M, IC	2¾"	6 lbs. 7 oz.	43"	1½"	2⅝"	14¾"	¼"
	Grayed	28	28"	013308813	5,109.00	F, M, IC	2¾"	6 lbs. 9 oz.	45"	1½"	2⅝"	14¾"	¼"
	Grayed	28	26"	013308814	5,109.00	F, M, IC	2¾"	6 lbs. 7 oz.	43"	1½"	2⅝"	14¾"	¼"
	Blued	.410	28"	013302913	5,109.00	F, M, IC	3"	6 lbs. 10 oz.	45"	1½"	2⅝"	14¾"	¼"
	Blued	.410	26"	013302914	5,109.00	F, M, IC	3"	6 lbs. 8 oz.	43"	1½"	2⅝"	14¾"	¼"
	Grayed	.410	28"	013308913	5,109.00	F, M, IC	3"	6 lbs. 10 oz.	45"	1½"	2⅝"	14¾"	¼"
	Grayed	.410	26"	013308914	5,109.00	F, M, IC	3"	6 lbs. 8 oz.	43"	1½"	2⅝"	14¾"	¼"

*NOTE: Weights listed are approximate.

CYNERGY®

A TOTALLY NEW EXPERIENCE IN OVER AND UNDER SHOTGUNS.

The innovative Browning Cynergy has shown the world a new and better way to build an over and under shotgun. With the lowest-profile, most compact receiver in the industry, a Cynergy is stronger and handles better and faster than the competition. Experience the difference modern design and technology can make.

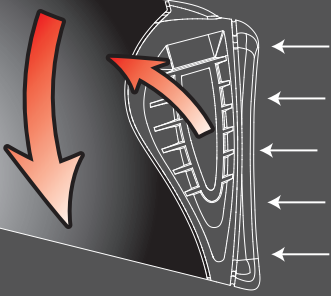

INFLEX TECHNOLOGY RECOIL PAD

The Inflex Technology Recoil Pad system provides long travel recoil reduction for a massive 25% decrease in felt recoil on 12 gauge guns and makes recoil virtually non-existent on small gauge guns. A slick Parylene coating allows the recoil pad to remain soft, yet prevents the pad from snagging on your clothing. Three pad lengths are available in ½" increments to provide length of pull adjustment to fit a wide variety of shooters. A ¼" spacer is included for customizing. See page 21 for accessories. (Inflex not available on Cynergy Classics.)

INFLEX TECHNOLOGY

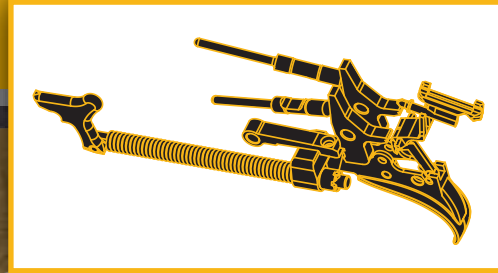

MECHANICAL TRIGGER

Cynergy shotguns feature the unique Reverse Striker ignition system, a striker-based, mechanical trigger. A mechanical trigger offers the benefits of a crisp feel, reduced locktime and less overtravel. This innovative, incredibly fast system outperforms the traditional hammer trigger systems found in most over and unders. Cynergy target models are equipped with the Triple Trigger™ System, allowing you to adjust the length of pull and switch between styles of trigger shoes: Wide checkered, narrow smooth and wide smooth canted.



ADJUSTABLE COMB

Composite models include an integrated, adjustable comb system to allow the gun to be easily customized to your individual taste. Drop at comb adjustments are made in ¼" increments. For cast on/cast off customizing, accessory combs can be purchased.

All Browning firearms are shipped with a free locking device to assist in the safe storage of firearms.





SUPERIOR GRIPPING SURFACES

Composite Cynergy models combine molded-in rubberized textured gripping surfaces and our proven Dura-Touch® Armor Coating for a sure hold and a sleek feel in all climate and weather conditions.

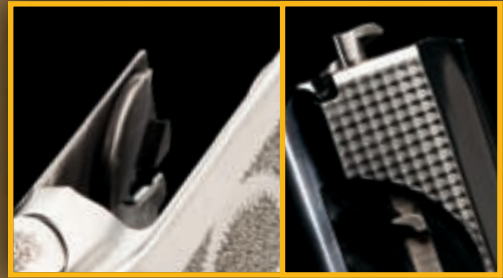

MONOLOCK HINGE The strong MonoLock Hinge is the reason for the Cynergy's low profile receiver. The MonoLock Hinge is the integration of the monobloc and the hinge, and has up to 300% more surface area to pivot on resulting in less wear. Rectangular locking pins provide extra strength and feature a "Wear-In Relief" that allows wear without hindering lock up. For 2010 all Cynergy models feature a jeweled monobloc for a beautiful appearance, smoother function and improved durability.

VECTOR PRO™ LENGTHENED FORCING CONES — NOW ON ALL 12 AND 20 GAUGE CYNERGY SHOTGUNS

We were the first manufacturer to recognize the advantages of a back-bored barrel and make it a standard feature on shotguns. Now we have gone a step further with Vector Pro, featuring a lengthened forcing cone that is over 2" longer than other systems. This long, gradual taper minimizes shot deformation and maximizes pattern uniformity, consistency and density. Back-boring increases bore diameter to its maximum specification, reducing friction between the shot cup and the barrel to propel the shot pellets to a higher velocity and reduce felt recoil. Reducing constriction from the forcing cone on the shot column results in fewer deformed pellets for more uniform patterns, and keeps more pellets in the central part of the pattern where they need to be to bag birds and targets. Our back-bore specifications represent the ideal bore diameter. A larger bore diameter can let gases slip by the shot cup, resulting in both reduced pellet velocity and blown patterns. A smaller bore diameter means the forcing cone can deform pellets, leading to poor ballistic performance and uneven, spotty pellet coverage on the target.

VECTORPRO™

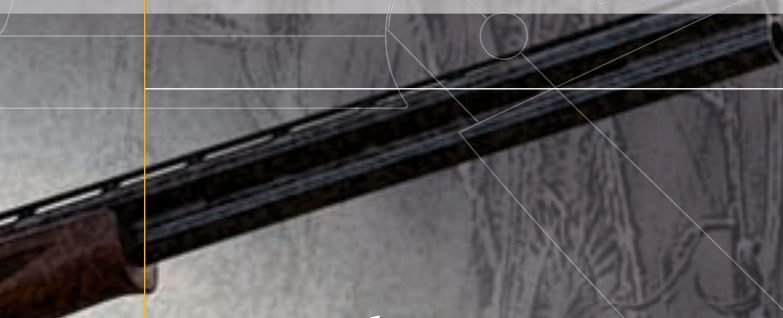

TOTAL BARREL DYNAMICS

CHROME CHAMBERS

To increase durability, all Cynergy shotguns feature chrome-plated chambers that resist the toll thousands of shells can take on lesser quality guns. Corrosion resistance is also greatly improved.

STEEL SHOT PERFORMANCE



The strength of a Browning barrel is legendary, and built to handle the punishment of steel shot. Unlike some manufacturers' barrels whose guns face an uncertain future after shooting steel, we have long been at the forefront of dependable steel shot performance and durability. Our barrels meet the strictest material and construction quality standards. The barrel blanks are made from rolled and tempered steel bars and are stress relieved to offer the best mechanical properties. The barrel blanks are then precision drilled, reamed and honed to exacting specifications. With proper care, Browning Cynergy barrels will last a lifetime.

IMPACT EJECTORS

Impact Ejectors ensure solid ejection of empty shells from the chamber. The ejectors are aided by the impact of a second striker spring, which gives more positive ejection than the push imparted by competitors' ejectors. The Cynergy's automatic ejectors positively eject fired shells when the breech is opened. Unfired shells are elevated for easy removal.



BACK-BORED TECHNOLOGY

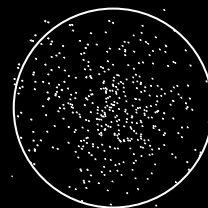

Browning pattern with Back-Bored Technology

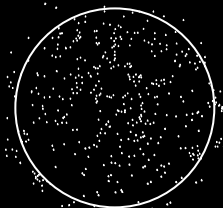

The competitors' pattern without Back-Bored Technology

CYNERGY FIELD ▶ GAUGE: 12 (SHOWN), 20, 28, .410 | GLOSS OIL FINISH



RECEIVER - Steel · Silver nitride finish · Ultra-low profile · MonoLock Hinge · Jewelled monobloc · High-relief engraving includes the receiver, forearm iron and top lever (12 gauge models illustrate pheasants and ducks. Small gauge models feature quail and grouse.)

BARREL - Lightweight profile · Ventilated top and side ribs

ACTION - Reverse Striker ignition system · Impact Ejectors · Top-tang barrel selector/safety

STOCK - Gloss oil finish and upgraded Grade II/III walnut

FEATURES - Vector Pro™ lengthened forcing cones on 12 and 20 · Three Investor-Plus™ choke tubes on 12 and 20 · Three Standard Investor™ on 28 and .410 · Inflex Technology Recoil Pad System · ¼" stock spacer · Ivory front and mid-bead sights

VECTORPRO



CYNERGY FEATHER ▶ GAUGE: 12 (SHOWN), 20, 28, .410 | GLOSS OIL FINISH



RECEIVER - Lightweight alloy with steel breech face · Gold enhanced grayed finish · Ultra-low profile · MonoLock Hinge · Jewelled monobloc

BARREL - Lightweight profile · Ventilated top and side ribs

ACTION - Reverse Striker ignition system · Impact Ejectors · Top-tang barrel selector/safety

STOCK - Gloss oil finish and upgraded Grade II/III walnut

FEATURES - Vector Pro™ lengthened forcing cones on 12 and 20 · Three Investor-Plus™ choke tubes on 12 and 20 · Three Standard Investor™ on 28 and .410 · Inflex Technology Recoil Pad System · ¼" stock spacer · Ivory front and mid-bead sights

VECTORPRO



CYNERGY FEATHER COMPOSITE WITH ADJUSTABLE COMB ▶ GAUGE: 12 | DURA-TOUCH® ARMOR COATING

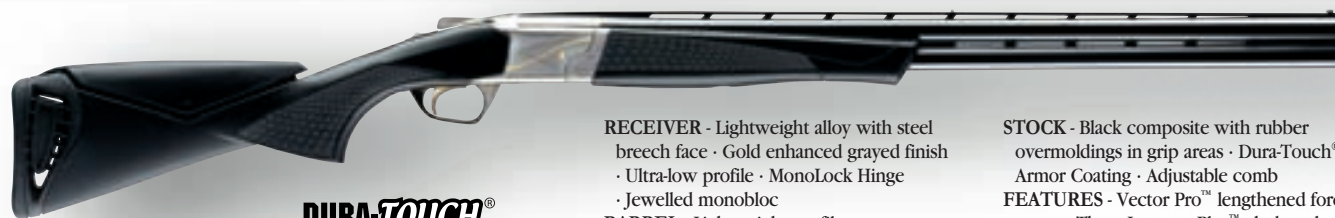

RECEIVER - Lightweight alloy with steel breech face · Gold enhanced grayed finish · Ultra-low profile · MonoLock Hinge · Jewelled monobloc

BARREL - Lightweight profile · Ventilated top and side ribs

ACTION - Reverse Striker ignition system · Impact Ejectors · Top-tang barrel selector/safety

STOCK - Black composite with rubber overmoldings in grip areas · Dura-Touch® Armor Coating · Adjustable comb

FEATURES - Vector Pro™ lengthened forcing cones · Three Investor-Plus™ choke tubes · Inflex Technology Recoil Pad System · ¼" stock spacer · Ivory front and mid-bead sights

DURA-TOUCH
Armor Coating

VECTORPRO



GA.	BARREL LENGTH	CODE NUMBER	SUGG. RETAIL	CHOKES INCLUDED	CHAMBER	*AVG. WEIGHT	OVERALL LENGTH	DROP AT COMB	DROP AT HEEL	LENGTH OF PULL	RIB WIDTH
CYNERGY FIELD											
12	28"	013297304	\$2,659.00	F, M, IC	3"	7 lbs. 11 oz.	45"	1¾"	2½"	14¼"	⅝"
12	26"	013297305	2,659.00	F, M, IC	3"	7 lbs. 9 oz.	43"	1¾"	2½"	14¼"	⅝"
20	28"	013297604	2,679.00	F, M, IC	3"	6 lbs. 4 oz.	45"	1½"	2⅝"	14¼"	⅞"
20	26"	013297605	2,679.00	F, M, IC	3"	6 lbs. 2 oz.	43"	1½"	2⅝"	14¼"	⅞"
28	28"	013297813	2,679.00	F, M, IC	2¾"	6 lbs. 4 oz.	45"	1½"	2⅝"	14¼"	⅞"
28	26"	013297814	2,679.00	F, M, IC	2¾"	6 lbs. 2 oz.	43"	1½"	2⅝"	14¼"	⅞"
.410	28"	013297913	2,679.00	F, M, IC	3"	6 lbs. 1 oz.	45"	1½"	2⅝"	14¼"	⅞"
.410	26"	013297914	2,679.00	F, M, IC	3"	5 lbs. 15 oz.	43"	1½"	2⅝"	14¼"	⅞"
CYNERGY FEATHER											
12	28"	013293304	\$2,719.00	F, M, IC	3"	6 lbs. 10 oz.	45"	1⅝"	2½"	14¼"	⅝"
12	26"	013293305	2,719.00	F, M, IC	3"	6 lbs. 8 oz.	43"	1⅝"	2½"	14¼"	⅝"
20	28"	013293604	2,749.00	F, M, IC	3"	5 lbs.	45"	1½"	2⅝"	14¼"	⅞"
20	26"	013293605	2,749.00	F, M, IC	3"	4 lbs. 14 oz.	43"	1½"	2⅝"	14¼"	⅞"
28	28"	013293813	2,749.00	F, M, IC	2¾"	5 lbs. 3 oz.	45"	1½"	2⅝"	14¼"	⅞"
28	26"	013293814	2,749.00	F, M, IC	2¾"	5 lbs. 1 oz.	43"	1½"	2⅝"	14¼"	⅞"
.410	28"	013293913	2,749.00	F, M, IC	3"	5 lbs.	45"	1½"	2⅝"	14¼"	⅞"
.410	26"	013293914	2,749.00	F, M, IC	3"	4 lbs. 14 oz.	43"	1½"	2⅝"	14¼"	⅞"
CYNERGY FEATHER COMPOSITE WITH ADJUSTABLE COMB											
12	28"	013275304	\$2,659.00	F, M, IC	3"	6 lbs. 8 oz.	45"	1⅝" Adj.	2½" Adj.	14¼"	⅝"
12	26"	013275305	2,659.00	F, M, IC	3"	6 lbs. 6 oz.	43"	1⅝" Adj.	2½" Adj.	14¼"	⅝"

*NOTE: Weights listed are approximate.



Cynergy Field, Left



Cynergy Field, Right

CYNERGY SPORTING ▶ GAUGE: 12 (SHOWN), 20 | GLOSS OIL FINISH

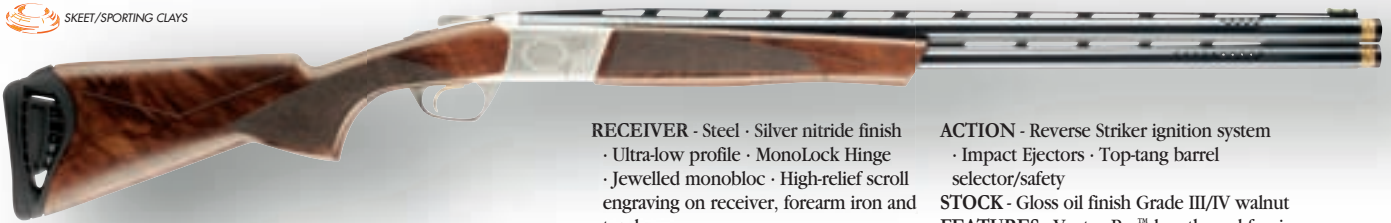

RECEIVER - Steel · Silver nitride finish
 · Ultra-low profile · MonoLock Hinge
 · Jewelled monobloc · High-relief scroll engraving on receiver, forearm iron and top lever
BARREL - Lightweight profile
 · Ventilated top and side ribs · Ported

ACTION - Reverse Striker ignition system
 · Impact Ejectors · Top-tang barrel selector/safety
STOCK - Gloss oil finish Grade III/IV walnut
FEATURES - Vector Pro™ lengthened forcing cones
 · Three Invector-Plus™ Diana™ Grade choke tubes
 · Inflex Technology Recoil Pad System · HiViz® Pro-Comp fiber-optic sight · ¼" stock spacer

VECTORPRO



CYNERGY SPORTING WITH ADJUSTABLE COMB ▶ GAUGE: 12 (SHOWN), 20 | GLOSS OIL FINISH

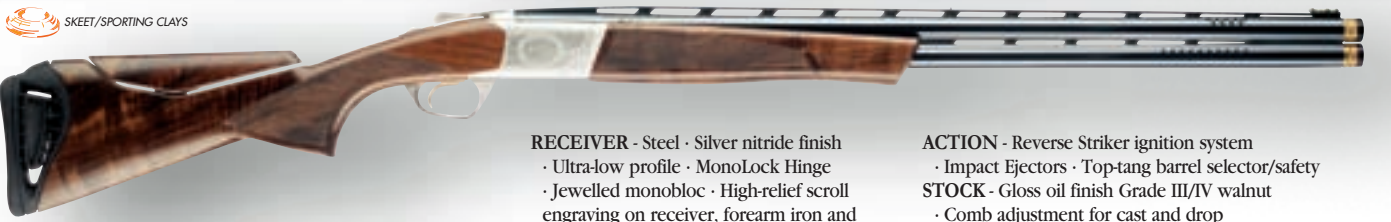

RECEIVER - Steel · Silver nitride finish
 · Ultra-low profile · MonoLock Hinge
 · Jewelled monobloc · High-relief scroll engraving on receiver, forearm iron and top lever
BARREL - Lightweight profile · Ventilated top and side ribs · Ported

ACTION - Reverse Striker ignition system
 · Impact Ejectors · Top-tang barrel selector/safety
STOCK - Gloss oil finish Grade III/IV walnut
 · Comb adjustment for cast and drop
FEATURES - Vector Pro™ lengthened forcing cones
 · Three Invector-Plus™ Diana™ Grade choke tubes
 · Inflex Technology Recoil Pad System · HiViz® Pro-Comp fiber-optic sight · ¼" stock spacer

VECTORPRO



CYNERGY SPORTING COMPOSITE WITH ADJUSTABLE COMB ▶ GAUGE: 12 | DURA-TOUCH® ARMOR COATING

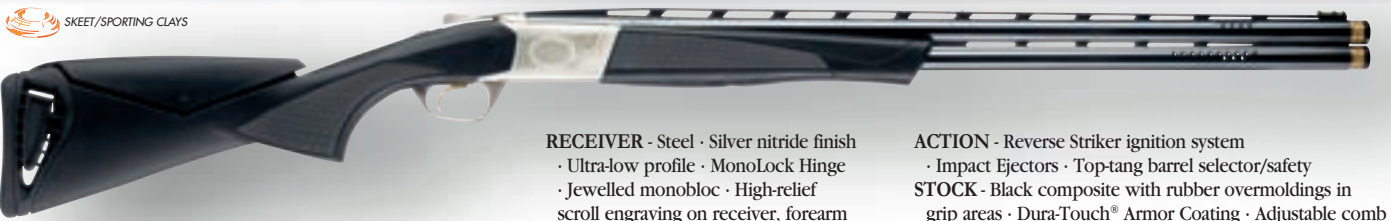

RECEIVER - Steel · Silver nitride finish
 · Ultra-low profile · MonoLock Hinge
 · Jewelled monobloc · High-relief scroll engraving on receiver, forearm iron and top lever
BARREL - Lightweight profile
 · Ventilated top and side ribs · Ported

ACTION - Reverse Striker ignition system
 · Impact Ejectors · Top-tang barrel selector/safety
STOCK - Black composite with rubber overmoldings in grip areas · Dura-Touch® Armor Coating · Adjustable comb
FEATURES - Vector Pro™ lengthened forcing cones
 · Three Invector-Plus™ Diana™ Grade choke tubes
 · Inflex Technology Recoil Pad System · HiViz® Pro-Comp fiber-optic sight · ¼" stock spacer

VECTORPRO



DURA-TOUCH®
 Armor Coating

GA.	BARREL LENGTH	CODE NUMBER	SUGG. RETAIL	CHOKES INCLUDED	CHAMBER	*AVG. WEIGHT	OVERALL LENGTH	DROP AT COMB	DROP AT HEEL	LENGTH OF PULL	RIB WIDTH (TAPERED)
CYNERGY SPORTING											
12	32"	013294326	\$3,919.00	M, IC, SK	3"	8 lbs. 1 oz.	50"	19/16"	23/8"	14 1/4"	(5/16" - 7/16")
12	30"	013294327	3,919.00	M, IC, SK	3"	7 lbs. 15 oz.	48"	19/16"	23/8"	14 1/4"	(5/16" - 7/16")
12	28"	013294328	3,919.00	M, IC, SK	3"	7 lbs. 13 oz.	46"	19/16"	23/8"	14 1/4"	(5/16" - 7/16")
20	32"	013294626	3,949.00	M, IC, SK	3"	6 lbs. 8 oz.	50"	19/16"	23/16"	14 1/4"	1/4"
20	30"	013294627	3,949.00	M, IC, SK	3"	6 lbs. 6 oz.	48"	19/16"	23/16"	14 1/4"	1/4"
20	28"	013294628	3,949.00	M, IC, SK	3"	6 lbs. 4 oz.	46"	19/16"	23/16"	14 1/4"	1/4"
CYNERGY SPORTING WITH ADJUSTABLE COMB											
12	32"	013295326	\$4,309.00	M, IC, SK	3"	8 lbs. 7 oz.	50"	1 5/8"	2 7/16" Adj.	14 1/4"	(5/16" - 7/16")
12	30"	013295327	4,309.00	M, IC, SK	3"	8 lbs. 5 oz.	48"	1 5/8"	2 7/16" Adj.	14 1/4"	(5/16" - 7/16")
12	28"	013295328	4,309.00	M, IC, SK	3"	8 lbs. 3 oz.	46"	1 5/8"	2 7/16" Adj.	14 1/4"	(5/16" - 7/16")
CYNERGY SPORTING COMPOSITE WITH ADJUSTABLE COMB											
12	32"	013296326	\$3,699.00	M, IC, SK	3"	7 lbs. 13 oz.	50"	1 9/16" Adj.	2 3/8" Adj.	14 1/4"	(5/16" - 7/16")
12	30"	013296327	3,699.00	M, IC, SK	3"	7 lbs. 11 oz.	48"	1 9/16" Adj.	2 3/8" Adj.	14 1/4"	(5/16" - 7/16")
12	28"	013296328	3,699.00	M, IC, SK	3"	7 lbs. 9 oz.	46"	1 9/16" Adj.	2 3/8" Adj.	14 1/4"	(5/16" - 7/16")

*NOTE: Weights listed are approximate.

CYNERGY CLASSIC FIELD GRADE III ▶ GAUGE: 12 (SHOWN), 20 | GLOSS FINISH



VECTORPRO™



Cynergy Classic Field Gr. III
12 Gauge, Bottom

Cynergy Classic Field Gr. III
12 Gauge, Left

Cynergy Classic Field Gr. III
12 Gauge, Right

Cynergy Classic Field Gr. III
20 Gauge, Bottom

Cynergy Classic Field Gr. III
20 Gauge, Left

Cynergy Classic Field Gr. III
20 Gauge, Right

RECEIVER - Steel · Silver nitride finish · Ultra-low profile
· Jewelled monobloc · MonoLock Hinge
· High-relief engraving includes the trigger guard, tang and top lever (12 gauge models illustrate pheasants on the left, mallards on the right. 20 gauge models feature teal and partridge.)

BARREL - Lightweight profile
· Ventilated top and side ribs
ACTION - Reverse Striker ignition system · Impact Ejectors · Top-tang barrel selector/safety

STOCK - Gloss finish Grade III/IV walnut
FEATURES - Vector Pro™ lengthened forcing cones
· Three Invector-Plus™ choke tubes · Ivory front and mid-bead sights · Recoil pad on 12 gauge model

CYNERGY CLASSIC FIELD GRADE VI ▶ GAUGE: 12 (SHOWN), 20 | GLOSS FINISH



VECTORPRO™



Cynergy Classic Field Gr. VI
12 Gauge, Bottom

Cynergy Classic Field Gr. VI
12 Gauge, Left

Cynergy Classic Field Gr. VI
12 Gauge, Right

Cynergy Classic Field Gr. VI
20 Gauge, Bottom

Cynergy Classic Field Gr. VI
20 Gauge, Left

Cynergy Classic Field Gr. VI
20 Gauge, Right

RECEIVER - Steel · Silver nitride finish · Ultra-low profile
· Jewelled monobloc · MonoLock Hinge · Full coverage high-relief engraving is gold enhanced and includes the trigger guard, tang and top lever (12 gauge models illustrate pheasants on the right, mallards on the left. 20 gauge models feature quail and grouse.)

BARREL - Lightweight profile
· Ventilated top and side ribs
ACTION - Reverse Striker ignition system
· Impact Ejectors · Top-tang barrel selector/safety

STOCK - Gloss finish Grade V/VI walnut
FEATURES - Vector Pro™ lengthened forcing cones
· Three Invector-Plus™ choke tubes · Ivory front and mid-bead sights · Recoil pad on 12 gauge model

GA.	BARREL LENGTH	CODE NUMBER	SUGG. RETAIL	CHOKES INCLUDED	CHAMBER	*AVG. WEIGHT	OVERALL LENGTH	DROP AT COMB	DROP AT HEEL	LENGTH OF PULL	RIB WIDTH
CYNERGY CLASSIC FIELD GRADE III											
12	28"	013252304	\$3,699.00	F, M, IC	3"	8 lbs. 1 oz.	45"	1 ⁵ / ₈ "	2 ¹ / ₂ "	14 ¹ / ₄ "	5 ¹ / ₁₆ "
12	26"	013252305	3,699.00	F, M, IC	3"	7 lbs. 15 oz.	43"	1 ⁵ / ₈ "	2 ¹ / ₂ "	14 ¹ / ₄ "	5 ¹ / ₁₆ "
20	28"	013252604	3,739.00	F, M, IC	3"	6 lbs. 10 oz.	45"	1 ¹ / ₂ "	2 ³ / ₈ "	14 ¹ / ₄ "	7 ¹ / ₃₂ "
20	26"	013252605	3,739.00	F, M, IC	3"	6 lbs. 8 oz.	43"	1 ¹ / ₂ "	2 ³ / ₈ "	14 ¹ / ₄ "	7 ¹ / ₃₂ "
CYNERGY CLASSIC FIELD GRADE VI											
12	28"	013253304	\$5,519.00	F, M, IC	3"	8 lbs. 1 oz.	45"	1 ⁵ / ₈ "	2 ¹ / ₂ "	14 ¹ / ₄ "	5 ¹ / ₁₆ "
12	26"	013253305	5,519.00	F, M, IC	3"	7 lbs. 15 oz.	43"	1 ⁵ / ₈ "	2 ¹ / ₂ "	14 ¹ / ₄ "	5 ¹ / ₁₆ "
20	28"	013253604	5,549.00	F, M, IC	3"	6 lbs. 10 oz.	45"	1 ¹ / ₂ "	2 ³ / ₈ "	14 ¹ / ₄ "	7 ¹ / ₃₂ "
20	26"	013253605	5,549.00	F, M, IC	3"	6 lbs. 8 oz.	43"	1 ¹ / ₂ "	2 ³ / ₈ "	14 ¹ / ₄ "	7 ¹ / ₃₂ "

*NOTE: Weights listed are approximate.

CYNERGY CLASSIC FIELD ▶ GAUGE: 12 (SHOWN), 20, 28, .410 | GLOSS OIL FINISH

NEW

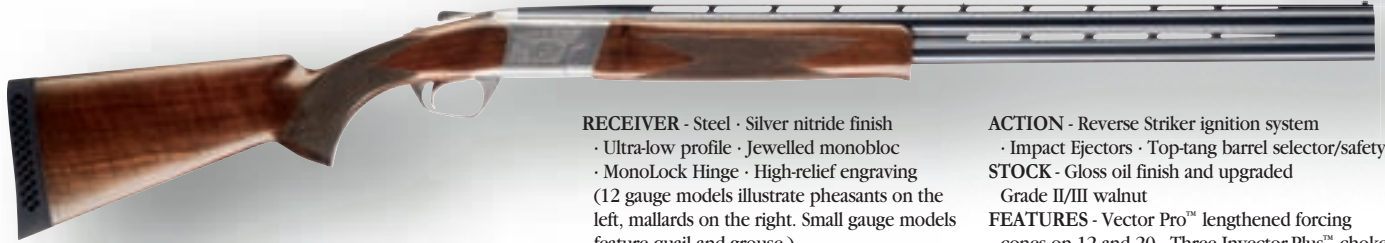

VECTORPRO™



BACK-BORED TECHNOLOGY

RECEIVER - Steel · Silver nitride finish
 · Ultra-low profile · Jewelled monobloc
 · MonoLock Hinge · High-relief engraving
 (12 gauge models illustrate pheasants on the left, mallards on the right. Small gauge models feature quail and grouse.)
BARREL - Lightweight profile · Ventilated top and side ribs

ACTION - Reverse Striker ignition system
 · Impact Ejectors · Top-tang barrel selector/safety
STOCK - Gloss oil finish and upgraded Grade II/III walnut
FEATURES - Vector Pro™ lengthened forcing cones on 12 and 20 · Three Invector-Plus™ choke tubes on 12 and 20 · Three Standard Invector™ on 28 and .410 · Ivory front and mid-bead sights · Recoil pad on 12 gauge model



Cynergy Classic Field 12 Gauge, Left



Cynergy Classic Field 12 Gauge, Right



Cynergy Classic Field 12 Gauge, Bottom

CYNERGY CLASSIC SPORTING ▶ GAUGE: 12 (SHOWN), 20, 28, .410 | GLOSS OIL FINISH

NEW



RECEIVER - Steel · Silver nitride finish
 · Ultra-low profile · Jewelled monobloc
 · MonoLock Hinge
BARREL - Lightweight profile
 · Ventilated top and side ribs · Ported
ACTION - Reverse Striker ignition system · Impact Ejectors · Top-tang barrel selector/safety
STOCK - Gloss oil finish Grade III/IV walnut
FEATURES - Vector Pro™ lengthened forcing cones on 12 and 20 · Three Invector-Plus™ Midas™ Grade choke tubes on 12 and 20 · Three Standard Invector™ on 28 and .410 · HiViz® Pro-Comp fiber-optic sight



Cynergy Classic Sporting, Right



Cynergy Classic Sporting, Bottom

VECTORPRO™



BACK-BORED TECHNOLOGY

	GA.	BARREL LENGTH	CODE NUMBER	SUGG. RETAIL	CHOKES INCLUDED	CHAMBER	*AVG. WEIGHT	OVERALL LENGTH	DROP AT COMB	DROP AT HEEL	LENGTH OF PULL	RIB WIDTH (TAPERED)
CYNERGY CLASSIC FIELD												
NEW	12	28"	013702304	\$2,399.00	F, M, IC	3"	7 lbs. 13 oz.	45"	1 5/8"	2 1/2"	14 1/4"	5/16"
NEW	12	26"	013702305	2,399.00	F, M, IC	3"	7 lbs. 11 oz.	43"	1 5/8"	2 1/2"	14 1/4"	5/16"
NEW	20	28"	013702604	2,429.00	F, M, IC	3"	6 lbs. 6 oz.	45"	1 1/2"	2 3/8"	14 1/4"	7/32"
NEW	20	26"	013702605	2,429.00	F, M, IC	3"	6 lbs. 4 oz.	43"	1 1/2"	2 3/8"	14 1/4"	7/32"
NEW	28	28"	013702813	2,429.00	F, M, IC	2 3/4"	6 lbs. 9 oz.	45"	1 1/2"	2 3/8"	14 1/4"	7/32"
NEW	28	26"	013702814	2,429.00	F, M, IC	2 3/4"	6 lbs. 7 oz.	43"	1 1/2"	2 3/8"	14 1/4"	7/32"
NEW	.410	28"	013702913	2,429.00	F, M, IC	3"	6 lbs. 6 oz.	45"	1 1/2"	2 3/8"	14 1/4"	7/32"
NEW	.410	26"	013702914	2,429.00	F, M, IC	3"	6 lbs. 4 oz.	43"	1 1/2"	2 3/8"	14 1/4"	7/32"
CYNERGY CLASSIC SPORTING												
NEW	12	32"	013703326	\$3,469.00	M, IC, SK	3"	7 lbs. 15 oz.	50"	1 9/16"	2 3/8"	14 3/4"	(5/16" - 7/16")
NEW	12	30"	013703327	3,469.00	M, IC, SK	3"	7 lbs. 13 oz.	48"	1 9/16"	2 3/8"	14 3/4"	(5/16" - 7/16")
NEW	12	28"	013703328	3,509.00	M, IC, SK	3"	7 lbs. 11 oz.	46"	1 9/16"	2 3/8"	14 3/4"	(5/16" - 7/16")
NEW	20	32"	013703626	3,509.00	M, IC, SK	3"	6 lbs. 8 oz.	50"	1 9/16"	2 3/16"	14 3/4"	1/4"
NEW	20	30"	013703627	3,509.00	M, IC, SK	3"	6 lbs. 6 oz.	48"	1 9/16"	2 3/16"	14 3/4"	1/4"
NEW	20	28"	013703628	3,509.00	M, IC, SK	3"	6 lbs. 4 oz.	46"	1 9/16"	2 3/16"	14 3/4"	1/4"
NEW	28	30"	013703812	3,509.00	M, IC, SK	2 3/4"	6 lbs. 9 oz.	48"	1 9/16"	2 3/16"	14 3/4"	1/4"
NEW	28	28"	013703813	3,509.00	M, IC, SK	2 3/4"	6 lbs. 7 oz.	46"	1 9/16"	2 3/16"	14 3/4"	1/4"
NEW	.410	30"	013703912	3,509.00	M, IC, SK	3"	6 lbs. 6 oz.	48"	1 9/16"	2 3/16"	14 3/4"	1/4"
NEW	.410	28"	013703913	3,509.00	M, IC, SK	3"	6 lbs. 4 oz.	46"	1 9/16"	2 3/16"	14 3/4"	1/4"

*NOTE: Weights listed are approximate.

CYNERGY CLASSIC SPORTING WITH ADJUSTABLE COMB ▶ GAUGE: 12 (SHOWN), 20 | GLOSS OIL FINISH

NEW

 SKEET/SPORTING CLAYS



RECEIVER - Steel · Silver nitride finish
 · Ultra-low profile · Jewelled monobloc
 · MonoLock Hinge
BARREL - Lightweight profile
 · Ventilated top and side ribs
 · Ported

ACTION - Reverse Striker ignition system
 · Impact Ejectors · Top-tang barrel selector/safety
STOCK - Grade III/IV gloss oil finish walnut
FEATURES - Vector Pro™ lengthened forcing cones · Three Invector-Plus™ Midas™ Grade choke tubes · HiViz® Pro-Comp fiber-optic sight



Cynergy Classic Sporting, Right



Cynergy Classic Sporting, Bottom

VECTORPRO®  

CYNERGY CLASSIC TRAP ▶ GAUGE: 12 | GLOSS FINISH

 TRAP



RECEIVER - Steel · Silver nitride finish
 · Ultra-low profile · Jewelled monobloc
 · MonoLock Hinge
BARREL - Lightweight profile
 · Tapered floating top rib · Ported
ACTION - Reverse Striker ignition system
 · Impact Ejectors · Top-tang barrel selector/safety

STOCK - Gloss finish Monte Carlo Grade III/IV walnut stock with right-hand palm swell
 · Modified semi-beavertail forearm with finger grooves
FEATURES - Vector Pro™ lengthened forcing cones · Three Invector-Plus™ Midas™ Grade choke tubes · HiViz® Pro-Comp fiber-optic sight

VECTORPRO®  

CYNERGY CLASSIC TRAP WITH ADJUSTABLE COMB ▶ GAUGE: 12 | GLOSS FINISH

 TRAP



RECEIVER - Steel · Silver nitride finish
 · Ultra-low profile · Jewelled monobloc
 · MonoLock Hinge
BARREL - Lightweight profile
 · Tapered floating top rib · Ported
ACTION - Reverse Striker ignition system
 · Impact Ejectors · Top-tang barrel selector/safety

STOCK - Gloss finish Monte Carlo Grade III/IV walnut stock with right-hand palm swell
 · Modified semi-beavertail forearm with finger grooves
FEATURES - Vector Pro™ lengthened forcing cones · Three Invector-Plus™ Midas™ Grade choke tubes · HiViz® Pro-Comp fiber-optic sight

VECTORPRO®  

	GA.	BARREL LENGTH	CODE NUMBER	SUGG. RETAIL	CHOKES INCLUDED	CHAMBER	*AVG. WEIGHT	OVERALL LENGTH	DROP AT COMB	DROP AT HEEL	LENGTH OF PULL	RIB WIDTH (TAPERED)
CYNERGY CLASSIC SPORTING WITH ADJUSTABLE COMB												
NEW	12	32"	013704326	\$3,739.00	M, IC, SK	3"	8 lbs. 11 oz.	50"	1¾" Adj.	2½" Adj.	14¾"	(⅝" - 7/16")
NEW	12	30"	013704327	3,739.00	M, IC, SK	3"	8 lbs. 9 oz.	48"	1¾" Adj.	2½" Adj.	14¾"	(⅝" - 7/16")
NEW	12	28"	013704328	3,739.00	M, IC, SK	3"	8 lbs. 7 oz.	46"	1¾" Adj.	2½" Adj.	14¾"	(⅝" - 7/16")
NEW	20	32"	013704626	3,759.00	M, IC, SK	3"	7 lbs. 4 oz.	50"	1⅝" Adj.	2⅝" Adj.	14¾"	¼"
NEW	20	30"	013704627	3,759.00	M, IC, SK	3"	7 lbs. 2 oz.	48"	1⅝" Adj.	2⅝" Adj.	14¾"	¼"
NEW	20	28"	013704628	3,759.00	M, IC, SK	3"	7 lbs.	46"	1⅝" Adj.	2⅝" Adj.	14¾"	¼"
CYNERGY CLASSIC TRAP												
	12	32"	013235426	\$3,739.00	F, F, IM	2¾"	8 lbs. 12 oz.	50¼"	1⅞"	2"	14⅞"	(¾" - ⅝")
	12	30"	013235427	3,739.00	F, F, IM	2¾"	8 lbs. 10 oz.	48¼"	1⅞"	2"	14⅞"	(¾" - ⅝")
CYNERGY CLASSIC TRAP WITH ADJUSTABLE COMB												
	12	32"	013254426	\$4,069.00	F, F, IM	2¾"	8 lbs. 15 oz.	50¼"	1⅞" Adj.	2" Adj.	14⅞"	(¾" - ⅝")
	12	30"	013254427	4,069.00	F, F, IM	2¾"	8 lbs. 13 oz.	48¼"	1⅞" Adj.	2" Adj.	14⅞"	(¾" - ⅝")

*NOTE: Weights listed are approximate.

CYNERGY CLASSIC TRAP UNSINGLE COMBO WITH ADJUSTABLE COMB ▶ GAUGE: 12 | GLOSS FINISH



VECTORPRO™



RECEIVER - Steel · Silver nitride finish
 · Ultra-low profile · Jewelled monobloc
 · MonoLock Hinge

BARREL - Double and single barrel sets included
 · Lightweight profile over and under barrel set
 · Single barrel set features an adjustable Unsingle Rib for fine tuning of rib angle for sight picture and point of impact · Ported

ACTION - Reverse Striker ignition system
 · Impact Ejectors · Top-tang barrel selector/safety

STOCK - Gloss finish Monte Carlo Grade III/IV walnut stock with right-hand palm swell
 · Modified semi-beavertail forearm with finger grooves

FEATURES - Vector Pro™ lengthened forcing cones
 · Four Invector-Plus™ Midas™ Grade choke tubes
 · HiViz® Pro-Comp fiber-optic sight · Green canvas fitted case with Browning Cynergy logo



GA.	BARREL LENGTH	CODE NUMBER	SUGG. RETAIL	CHOKES INCLUDED	CHAMBER	*AVG. WEIGHT	OVERALL LENGTH	DROP AT COMB	DROP AT HEEL	LENGTH OF PULL	RIB WIDTH (TAPERED)
CYNERGY CLASSIC TRAP UNSINGLE COMBO WITH ADJUSTABLE COMB											
12	32"/34"	013269479	\$5,549.00	F, F, F, IM	2¾"	8 lbs. 15 oz.	48¼" / 50¼"	1¼" Adj.	2" Adj.	14¾"	(¼" - ¾")
12	32"/32"	013269469	5,549.00	F, F, F, IM	2¾"	8 lbs. 15 oz.	48¼"	1¼" Adj.	2" Adj.	14¾"	(¼" - ¾")
12	30"/34"	013269468	5,549.00	F, F, F, IM	2¾"	8 lbs. 13 oz.	46¼" / 50¼"	1¼" Adj.	2" Adj.	14¾"	(¼" - ¾")
12	30"/32"	013269467	5,549.00	F, F, F, IM	2¾"	8 lbs. 13 oz.	46¼" / 48¼"	1¼" Adj.	2" Adj.	14¾"	(¼" - ¾")

*NOTE: Weights listed are approximate.

CYNERGY ACCESSORIES ▶ RECOIL PADS | SPACERS | COMBS

Recoil Pads for Composite Models*



Recoil Pads for Wood Models*

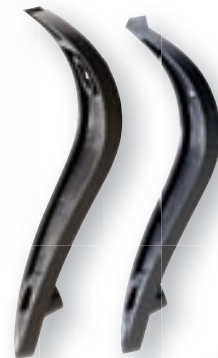

Spacers



DESCRIPTION	CODE #	SUGG. RETAIL
Short Composite Recoil Pad	11400	\$34.99
Medium Composite Recoil Pad	11401	34.99
Long Composite Recoil Pad	11402	34.99
Short Wood Recoil Pad	11410	34.99
Medium Wood Recoil Pad	11411	34.99
Long Wood Recoil Pad	11412	34.99
¼" Composite Stock Spacer	11430	7.99
¼" Wood Stock Spacer	11431	7.99
Cast-on Adj. Comb, Composite	11420	24.99
Cast-off Adj. Comb, Composite	11421	24.99

*NOTE: All new guns are shipped with medium pads. Length of pull adjustable from 13¼"-15". See page 14 for details on Inflex pads.



Composite Model Adjustable Comb

BT-99

DOLLAR FOR DOLLAR, THE BEST THERE IS. There is simply not a better dedicated trap gun than the classic Browning BT-99. Its performance and durability are legendary, with many a BT-99 being the first and only trap gun many competition shooters will ever choose.

VECTOR PRO™ LENGTHENED FORCING CONE

Vector Pro's lengthened forcing cone is more than 2" longer than the competition. This long, gradual taper minimizes shot deformation and maximizes pattern uniformity, consistency and density. Vector Pro takes bore diameter to its maximum specification, reducing friction between the shot cup and the barrel to propel the shot pellets to a higher velocity and reduce felt recoil. Reducing constriction from the forcing cone on the shot column results in fewer deformed pellets for more uniform patterns, and keeps more pellets in the central part of the pattern where they need to be for you to dust more targets.

VECTORPRO™

All Browning firearms are shipped with a free locking device to assist in the safe storage of firearms.

TOTAL BARREL DYNAMICS

INVECTOR -PLUS™ CHOKE TUBE SYSTEM

The Invector-Plus interchangeable choke tube system provides consistent, dense shot patterns in the constriction needed for your shooting situation. The longer choke taper inside an Invector-Plus choke tube works with Back-Bored Technology to produce patterns with more uniform densities and fewer fliers. The superior design eliminates gases slipping between the choke tube and barrel that could damage the choke tube and the barrel. See pages 124 to 127 for a complete listing of choke tubes.

CHROME CHAMBERS

The BT-99 features a chrome-plated chamber to resist the toll thousands of shells can take on lesser quality guns. Corrosion resistance is also greatly improved.



FOREARM

A beavertail forearm helps control recoil and assists hand-eye coordination.



RIB

High-post, 1/32" rib.

EXTRACTOR The BT-99 features an extractor only.

BT-99 GRADE III ▶ GAUGE: 12 | GLOSS FINISH

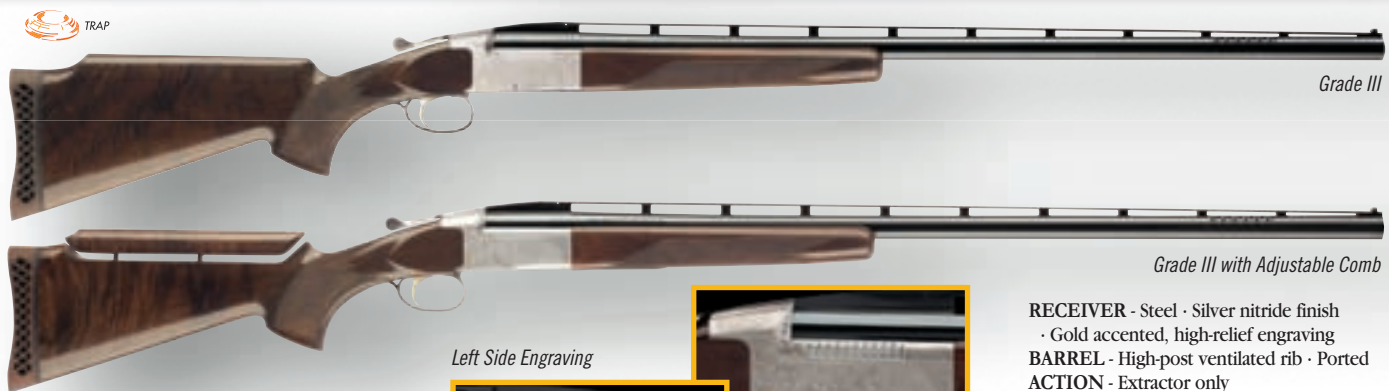

VECTORPRO™

STEEL SHOT PERFORMANCE

BACK-BORED TECHNOLOGY

Left Side Engraving



Right Side Engraving



RECEIVER - Steel · Silver nitride finish
 · Gold accented, high-relief engraving
BARREL - High-post ventilated rib · Ported
ACTION - Extractor only
STOCK - Gloss finish Monte Carlo Grade III/IV walnut stock · Beavertail forearm
FEATURES - Vector-Pro™ lengthened forcing cone · Three Invector-Plus™ choke tubes
 · Adjustable comb optional · Ivory front and mid-bead sights

GA.	BARREL LENGTH	CODE NUMBER	SUGG. RETAIL	CHOKES INCLUDED	CHAMBER	*AVG. WEIGHT	OVERALL LENGTH	DROP AT COMB	DROP AT HEEL	LENGTH OF PULL	RIB WIDTH
BT-99 GRADE III											
12	34"	017070425	\$2,399.00	F, IM, M	2¾"	8 lbs. 6 oz.	51"	1¾"	2"	14¾"	1½/32"
12	32"	017070426	2,399.00	F, IM, M	2¾"	8 lbs. 5 oz.	49"	1¾"	2"	14¾"	1½/32"
BT-99 GRADE III WITH ADJUSTABLE COMB											
12	34"	017071425	\$2,669.00	F, IM, M	2¾"	8 lbs. 6 oz.	51"	1¼" Adj.	2" Adj.	14¾"	1½/32"
12	32"	017071426	2,669.00	F, IM, M	2¾"	8 lbs. 5 oz.	49"	1¼" Adj.	2" Adj.	14¾"	1½/32"

*NOTE: Weights listed are approximate.

BT-99 GOLDEN CLAYS WITH ADJUSTABLE COMB ▶ GAUGE: 12 | GLOSS FINISH

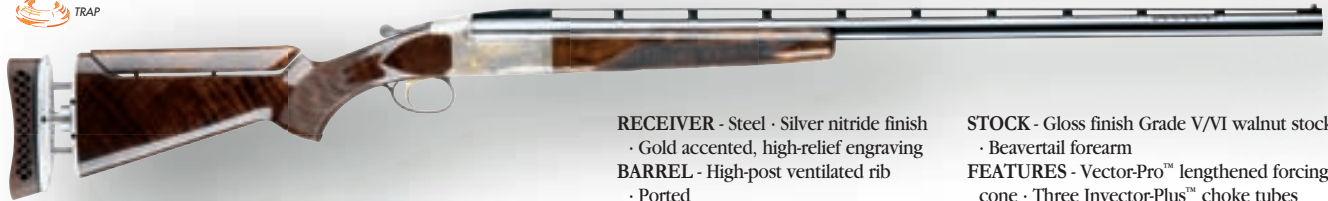

VECTORPRO™



BACK-BORED TECHNOLOGY

RECEIVER - Steel · Silver nitride finish
· Gold accented, high-relief engraving
BARREL - High-post ventilated rib
· Ported
ACTION - Extractor only

STOCK - Gloss finish Grade V/VI walnut stock
· Beavertail forearm
FEATURES - Vector-Pro™ lengthened forcing cone · Three Invector-Plus™ choke tubes
· Adjustable straight comb · Adjustable GraCoil® recoil reduction system · Ivory front and mid-bead sights

BT-99 ▶ GAUGE: 12 | SATIN FINISH



VECTORPRO™



BACK-BORED TECHNOLOGY

RECEIVER - Steel · Blued finish
BARREL - High-post ventilated rib
ACTION - Extractor only

STOCK - Satin finish walnut stock
· Beavertail forearm
FEATURES - Vector-Pro™ lengthened forcing cone · Adjustable straight comb optional · Recoil pad · Ivory front and mid-bead sights

BT-99 MICRO ▶ GAUGE: 12 | SATIN FINISH



VECTORPRO™



BACK-BORED TECHNOLOGY

RECEIVER - Steel · Blued finish
BARREL - High-post ventilated rib
ACTION - Extractor only

STOCK - Satin finish walnut stock
· Beavertail forearm · Scaled down to comfortably fit smaller shooters
FEATURES - Vector-Pro™ lengthened forcing cone · Recoil pad · Ivory front and mid-bead sights

GA.	BARREL LENGTH	CODE NUMBER	SUGG. RETAIL	CHOKES INCLUDED	CHAMBER	*AVG. WEIGHT	OVERALL LENGTH	DROP AT COMB	DROP AT HEEL	LENGTH OF PULL	RIB WIDTH
BT-99 GOLDEN CLAYS WITH ADJUSTABLE COMB											
12	34"	017057401	\$3,999.00	F, IM, M	2¾"	9 lbs.	51"	1⅞" Adj.	1¾" Adj.	13⅜" - 14⅜"	1½"
12	32"	017057402	3,999.00	F, IM, M	2¾"	8 lbs. 15 oz.	49"	1⅞" Adj.	1¾" Adj.	13⅜" - 14⅜"	1½"
BT-99 (SHOWN)											
12	34"	017054401	\$1,339.00	Full	2¾"	8 lbs. 5 oz.	51"	1⅞"	1⅝"	14⅜"	1½"
12	32"	017054402	1,339.00	Full	2¾"	8 lbs. 4 oz.	49"	1⅞"	1⅝"	14⅜"	1½"
BT-99 WITH ADJUSTABLE COMB											
12	34"	017055401	\$1,599.00	Full	2¾"	8 lbs. 5 oz.	51"	1⅞" Adj.	1¾" Adj.	14⅜"	1½"
12	32"	017055402	1,599.00	Full	2¾"	8 lbs. 4 oz.	49"	1⅞" Adj.	1¾" Adj.	14⅜"	1½"
BT-99 MICRO											
12	32"	017061402	\$1,339.00	Full	2¾"	7 lbs. 13 oz.	48½"	1⅞"	1⅝"	13¾"	1½"
12	30"	017061403	1,339.00	Full	2¾"	7 lbs. 12 oz.	46½"	1⅞"	1⅝"	13¾"	1½"

*NOTE: Weights listed are approximate.

BROWNING GROWTH INSURANCE PROGRAM

The secret is out, people get bigger. And when they do, they need a shotgun with a longer length of pull to fit their growing frame. Because shotguns are expensive, you might choose a cheaper model or those small of stature are forced to shoot a full-size firearm that will impair performance. That's why we offer the Growth Insurance Program. For a limited time, when you purchase a new BT-99 Micro, Silver Sporting Micro, BPS Micro Trap or BPS Micro you are eligible to purchase a full-size stock down the road at 50% off the retail price. That's a significant savings and allows you to purchase a shotgun of the highest quality that is guaranteed to fit and maximize shooting performance for years to come. Visit browning.com for complete details or to download a coupon for this program.



SILVER — PROVEN RELIABILITY, PERFORMANCE AND LASTING VALUE.

The Silver dutifully honors the tradition of rugged and reliable Browning autoloading shotguns.

The highest levels of craftsmanship, fit and finish, handling, versatility and accuracy go into every Silver. The iconic semi-humpback receiver shape has been a Browning hallmark for more than 100 years.

TOTAL BARREL DYNAMICS

BACK-BORED BARREL TECHNOLOGY

We were the first manufacturer to recognize the advantages of a back-bored barrel. Back-boring increases the bore diameter to reduce friction between the shot cup and the barrel to maximize shot velocity and reduce felt recoil. Through intense research, our back-bore specifications have been perfected and represent the ideal bore diameter needed to minimize shot deformation and maximize pattern uniformity, consistency and density. Any larger and gases slip by the shot cup, resulting in reduced pellet velocity and blown patterns. Any smaller, and the forcing cone will deform pellets and result in poor ballistic performance, fliers and uneven, spotty pellet coverage on the target.

INVECTOR-PLUS™ CHOKE TUBE SYSTEM

The proven Invector-Plus interchangeable choke tube system comes on every Silver shotgun to provide consistent, dense shot patterns in just the constriction needed for your shooting situation. The longer choke taper inside an Invector-Plus choke tube works hand-in-hand with Back-Bored Technology to produce consistent patterns with more uniform densities and fewer fliers. The superior design of the Invector-Plus system is far more durable than the choke systems found in competitors' guns, especially when shooting steel shot loads. Invector-Plus eliminates gases slipping between the choke tube and barrel that could damage the choke tube and the barrel. See pages 124 to 127 for a complete listing of choke tubes.

STEEL SHOT PERFORMANCE

The strength of a Browning barrel is legendary, and built to handle the punishment of steel shot. Unlike some manufacturers' barrels whose guns face an uncertain future after shooting steel, we have long been at the forefront of dependable steel shot performance and durability. Our barrels meet the strictest material and construction quality standards.

The barrel blanks are made from rolled and tempered steel bars and are stress relieved to offer the best mechanical properties. The barrel blanks are then precision drilled, reamed and honed to exacting specifications. With proper care, Browning Silver barrels will last a lifetime.



Silver

BACK-BORED TECHNOLOGY

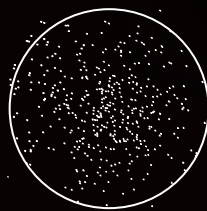

Browning pattern with Back-Bored Technology

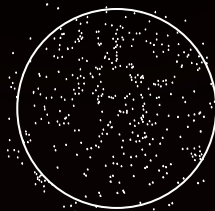

The competitors' pattern without Back-Bored Technology



LOAD VERSATILITY The Active Valve-equipped gas piston efficiently adjusts to reliably fire a wide range of loads. 12 gauge 3" models fire everything from light, 1 oz., 2¾" target loads to the heaviest 3" magnums. The larger 3½" version is built to handle a similar range, from 1½ oz., 2¾" field loads up to hard-hitting 3½" magnums. Competitors' guns can't match this versatility.



LESS RECOIL WITH THE ACTIVE VALVE

The self-adjusting Active Valve gas system in Silver autoloaders uses gases from fired shells to operate the action instead of contributing to recoil. When shooting light loads, most of the gases operate the action. With magnum loads, only a small amount of gas is necessary to operate the action, while the remaining gases are vented through the Active Valve and out the top of the forearm and away from the receiver for clean, reliable operation. The gas piston and Active Valve operate independently, putting less pressure on the gas piston for greater longevity and more efficient operation than the competitions' gas-operated autoloaders. Because the Active Valve expels unnecessary gases, it reduces recoil before it ever reaches the shoulder — without the need for heavy hydraulic recoil dampers, sticky gel pads and gimmicky gel stock inserts. Superior recoil reduction from the Active Valve also equals faster, more accurate follow-up shots and all-day shooting comfort regardless of the loads used.



Light Load (1 oz.)



Heavy Load (2 oz.)

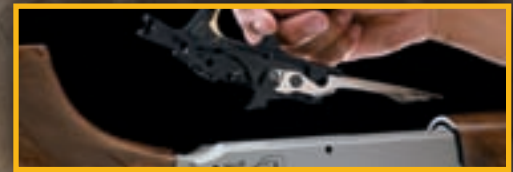

TRIGGER

The trigger guard is large and has carefully rounded edges to accommodate gloved fingers. Additionally, the Silver's entire trigger assembly can be removed in just seconds for thorough cleaning.

MAGAZINE CAPACITY

2¾": Four in magazine, one in chamber.

3": Three in magazine, one in chamber.

3½": Three in magazine, one in chamber.

(A three-shot magazine adapter plug is included.)

All Browning firearms are shipped with a free locking device to assist in the safe storage of firearms.



MAXIMUM GRIP

Composite Silver models combine checkered gripping surfaces and proven Dura-Touch® Armor Coating for a sure hold and a sleek feel in all climate conditions.

SILVER HUNTER ▶ GAUGE: 12 (SHOWN), 20 | SATIN FINISH



RECEIVER - Strong, lightweight aluminum alloy
 · Semi-humpback design · Silver finish
BARREL - Lightweight profile · Ventilated rib
ACTION - Gas-operated autoloader · 3" and 3½" chamber models · Active Valve reliably cycles a wide range of loads
STOCK - Satin finish walnut stock and forearm
FEATURES - Three Invector-Plus™ choke tubes · Ivory front bead sight



SILVER MICRO ▶ GAUGE: 20 | SATIN FINISH

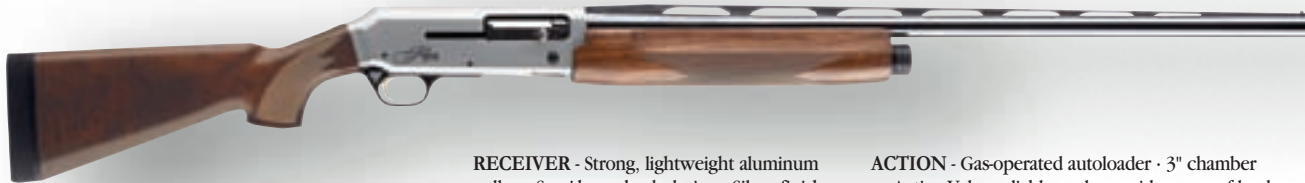

RECEIVER - Strong, lightweight aluminum alloy · Semi-humpback design · Silver finish
BARREL - Lightweight profile
 · Ventilated rib

ACTION - Gas-operated autoloader · 3" chamber
 · Active Valve reliably cycles a wide range of loads
STOCK - Satin finish walnut stock and forearm
 · Compact stock dimensions fit smaller shooters
FEATURES - Three Invector-Plus™ choke tubes
 · Ivory front bead sight



SILVER SPORTING MICRO ▶ GAUGE: 12 | GLOSS FINISH

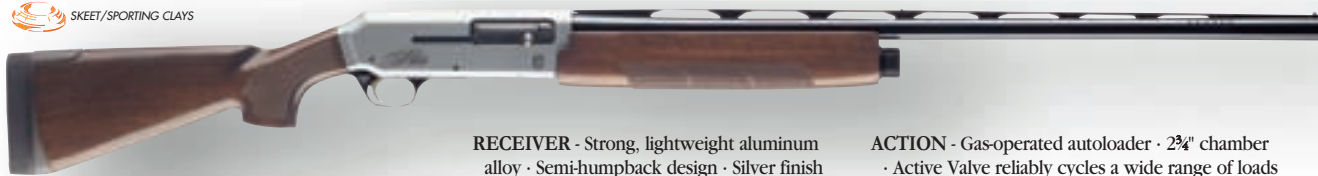

RECEIVER - Strong, lightweight aluminum alloy · Semi-humpback design · Silver finish
BARREL - Lightweight profile
 · Ventilated rib · Ported

ACTION - Gas-operated autoloader · 2¾" chamber
 · Active Valve reliably cycles a wide range of loads
STOCK - Gloss finish walnut stock and forearm
 · Stock features ¾" length of pull adjustment in ¼" increments using the three included adjustment spacers · Premium Pachmayr® Decelerator® recoil pad
FEATURES - Three Invector-Plus™ choke tubes
 · Ivory front bead sight



	GA.	BARREL LENGTH	CODE NUMBER	SUGG. RETAIL	CHOKES INCLUDED	CHAMBER	*AVG. WEIGHT	OVERALL LENGTH	DROP AT COMB	DROP AT HEEL	LENGTH OF PULL	RIB WIDTH
SILVER HUNTER												
	12	28"	011350204	\$1,259.00	F, M, IC	3½"	7 lbs. 9 oz.	49"	1¾"	2"	14¾"	¼"
	12	26"	011350205	1,259.00	F, M, IC	3½"	7 lbs. 8 oz.	47"	1¾"	2"	14¾"	¼"
	12	30"	011350303	1,069.00	F, M, IC	3"	7 lbs. 6 oz.	51"	1¾"	2"	14¾"	¼"
	12	28"	011350304	1,069.00	F, M, IC	3"	7 lbs. 5 oz.	49"	1¾"	2"	14¾"	¼"
	12	26"	011350305	1,069.00	F, M, IC	3"	7 lbs. 4 oz.	47"	1¾"	2"	14¾"	¼"
	20	28"	011350604	1,069.00	F, M, IC	3"	6 lbs. 7 oz.	48¾"	1¾"	2¼"	14¾"	¼"
	20	26"	011350605	1,069.00	F, M, IC	3"	6 lbs. 5 oz.	46¾"	1¾"	2¼"	14¾"	¼"
SILVER MICRO												
	20	26"	011375605	\$1,069.00	F, M, IC	3"	6 lbs. 3 oz.	46"	1½"	1¾"	13⅝"	¼"
SILVER SPORTING MICRO												
	12	28"	011373428	\$1,219.00	F, M, IC	2¾"	7 lbs.	48"	1½"	1¾"	13⅝" Adj.	¼"

*NOTE: Weights listed are approximate.

SILVER SPORTING ▶ GAUGE: 12 | GLOSS FINISH

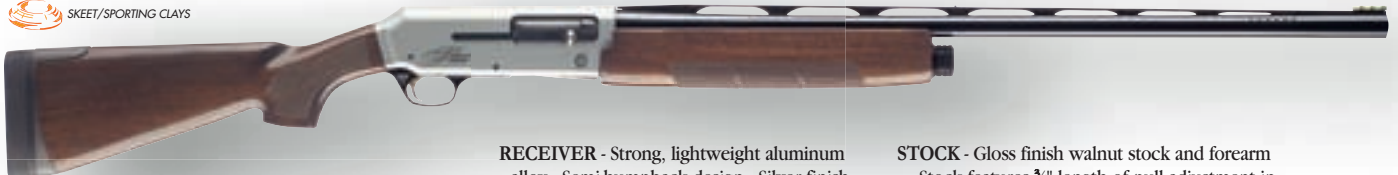

RECEIVER - Strong, lightweight aluminum alloy · Semi-humpback design · Silver finish
BARREL - Lightweight profile · Ventilated rib · Ported
ACTION - Gas-operated autoloader · 2¾" chamber · Active Valve reliably cycles a wide range of loads

STOCK - Gloss finish walnut stock and forearm · Stock features ¾" length of pull adjustment in ¼" increments using the three included adjustment spacers · Premium Pachmayr® Decelerator® recoil pad
FEATURES - Three Invector-Plus™ choke tubes · HiViz® TriComp fiber-optic sight · Two Active Valve pistons included to optimize performance with light or heavy loads

SILVER LIGHTNING FULL LINE DEALER ▶ GAUGE: 12 | GLOSS FINISH



RECEIVER - Aluminum alloy · Semi-humpback design · Silver finish
BARREL - Lightweight profile · Ventilated rib

ACTION - Gas-operated autoloader · 3" and 3½" chamber models · Active Valve reliably cycles a wide range of loads
STOCK - Gloss finish · Classic Lightning-style walnut stock
FEATURES - Three Invector-Plus™ choke tubes · Ivory front bead sight · Available only from Browning Full Line and Medallion Dealers

SILVER STALKER ▶ GAUGE: 12 | DURA-TOUCH® ARMOR COATING



RECEIVER - Aluminum alloy · Semi-humpback design
BARREL - Lightweight profile · Ventilated rib

ACTION - Gas-operated autoloader · 3½" chamber · Active Valve reliably cycles a wide range of loads
STOCK - Composite stock and forearm · Matte black finish · Dura-Touch® Armor Coating
FEATURES - Three Invector-Plus™ choke tubes · Ivory front bead sight

GA.	BARREL LENGTH	CODE NUMBER	SUGG. RETAIL	CHOKES INCLUDED	CHAMBER	*AVG. WEIGHT	OVERALL LENGTH	DROP AT COMB	DROP AT HEEL	LENGTH OF PULL	RIB WIDTH
SILVER SPORTING											
12	30"	011377427	\$1,219.00	F, M, IC	2¾"	7 lbs. 9 oz.	50¾"	1½"	1¾"	14¼" Adj.	¼"
12	28"	011377428	1,219.00	F, M, IC	2¾"	7 lbs. 8 oz.	48¾"	1½"	1¾"	14¼" Adj.	¼"
SILVER LIGHTNING FULL LINE DEALER											
12	28"	011368204	\$1,279.00	F, M, IC	3½"	7 lbs. 9 oz.	49"	1¾"	2"	14¼"	¼"
12	26"	011368205	1,279.00	F, M, IC	3½"	7 lbs. 8 oz.	47"	1¾"	2"	14¼"	¼"
12	28"	011368304	1,109.00	F, M, IC	3"	7 lbs. 6 oz.	49"	1¾"	2"	14¼"	¼"
12	26"	011368305	1,109.00	F, M, IC	3"	7 lbs. 4 oz.	47"	1¾"	2"	14¼"	¼"
SILVER STALKER											
12	28"	011351204	\$1,199.00	F, M, IC	3½"	7 lbs. 9 oz.	49"	1¾"	2"	14¼"	¼"
12	26"	011351205	1,199.00	F, M, IC	3½"	7 lbs. 8 oz.	47"	1¾"	2"	14¼"	¼"

*NOTE: Weights listed are approximate.

SILVER MOSSY OAK® BREAK-UP® INFINITY ▶ GAUGE: 12 | DURA-TOUCH® ARMOR COATING



NEW FOR 2010



Mossy Oak Break-Up Infinity camo will replace New Break-Up camo on this Browning firearm.



RECEIVER - Aluminum alloy
 · Semi-humpback design
BARREL - Lightweight profile · Ventilated rib
ACTION - Gas-operated autoloader · 3½" chamber · Active Valve reliably cycles a wide range of loads

STOCK - Composite stock and forearm
 · Dura-Touch® Armor Coating
 · Mossy Oak® Break-Up Infinity camo finish
FEATURES - Three Invector-Plus™ choke tubes · Ivory front bead sight

SILVER MOSSY OAK® DUCK BLIND® ▶ GAUGE: 12 | DURA-TOUCH® ARMOR COATING



RECEIVER - Aluminum alloy
 · Semi-humpback design
BARREL - Lightweight profile
 · Ventilated rib

ACTION - Gas-operated autoloader · 3½" chamber
 · Active Valve reliably cycles a wide range of loads
STOCK - Composite stock and forearm
 · Dura-Touch® Armor Coating
 · Mossy Oak® Duck Blind® camo finish
FEATURES - Three Invector-Plus™ choke tubes
 · Ivory front bead sight

SILVER NWTf, MOSSY OAK® BREAK-UP® INFINITY ▶ GAUGE: 12 | DURA-TOUCH® ARMOR COATING



NEW FOR 2010

Mossy Oak Break-Up Infinity camo will replace New Break-Up camo on this Browning firearm.



RECEIVER - Aluminum alloy
 · Semi-humpback design
BARREL - Lightweight profile
 · Ventilated rib

ACTION - Gas-operated autoloader · 3" and 3½" chamber models · Active Valve reliably cycles a wide range of loads
STOCK - Composite stock and forearm
 · Dura-Touch® Armor Coating
 · Mossy Oak® Break-Up Infinity camo finish
FEATURES - HiViz® 4-in-1 fiber-optic sight
 · Three Invector-Plus™ choke tubes



ULTIMATE CONCEALMENT

Browning has a long-standing partnership with Mossy Oak® brand camouflage. Their cutting edge patterns offer three-dimensional realism for concealment that blends into nature better than any other camouflage brand.

	GA.	BARREL LENGTH	CODE NUMBER	SUGG. RETAIL	CHOKES INCLUDED	CHAMBER	*AVG. WEIGHT	OVERALL LENGTH	DROP AT COMB	DROP AT HEEL	LENGTH OF PULL	RIB WIDTH
SILVER MOSSY OAK BREAK-UP INFINITY												
NEW	12	26"	011384205	\$1,349.00	F, M, IC	3½"	7 lbs. 8 oz.	47"	1¾"	2"	14¾"	¼"
SILVER MOSSY OAK DUCK BLIND												
	12	28"	011366204	\$1,349.00	F, M, IC	3½"	7 lbs. 9 oz.	49"	1¾"	2"	14¾"	¼"
	12	26"	011366205	1,349.00	F, M, IC	3½"	7 lbs. 8 oz.	47"	1¾"	2"	14¾"	¼"
SILVER NWTf, MOSSY OAK BREAK-UP INFINITY												
NEW	12	24"	011385206	\$1,439.00	Full Str Trky, M, IC	3½"	7 lbs. 4 oz.	45"	1¾"	2"	14¾"	¼"
NEW	12	24"	011385306	1,279.00	XF, M, IC	3"	7 lbs.	45"	1¾"	2"	14¾"	¼"

*NOTE: Weights listed are approximate.

SILVER RIFLED DEER MOSSY OAK® BREAK-UP® INFINITY ▶ GAUGE: 12 | DURA-TOUCH® ARMOR COATING



NEW FOR 2010 **NEW**
Mossy Oak Break-Up Infinity camo will replace
New Break-Up camo on this Browning firearm.



RECEIVER - Aluminum alloy
· Semi-humpback design
BARREL - Thick-walled for
slug ammunition only

ACTION - Gas-operated autoloader · 3" chamber
· Active Valve reliably cycles a wide range of loads
STOCK - Composite stock and forearm · Dura-Touch®
Armor Coating Mossy Oak® Break-Up Infinity camo finish
FEATURES - Cantilever scope mount

SILVER RIFLED DEER STALKER ▶ GAUGE: 12 | DURA-TOUCH® ARMOR COATING



RECEIVER - Aluminum alloy
· Semi-humpback design
BARREL - Thick-walled for
slug ammunition only

ACTION - Gas-operated autoloader · 3" chamber
· Active Valve reliably cycles a wide range of loads
STOCK - Composite stock and forearm · Dura-Touch®
Armor Coating · Matte black finish
FEATURES - Cantilever scope mount

SILVER RIFLED DEER SATIN ▶ GAUGE: 20 | SATIN FINISH



RECEIVER - Aluminum alloy
· Semi-humpback design
BARREL - Thick-walled for
slug ammunition only

ACTION - Gas-operated autoloader · 3" chamber
· Active Valve reliably cycles a wide range of loads
STOCK - Satin finish walnut
FEATURES - Cantilever scope mount

	GA.	BARREL LENGTH	CODE NUMBER	SUGG. RETAIL	CHOKES INCLUDED	CHAMBER	*AVG. WEIGHT	OVERALL LENGTH	DROP AT COMB	DROP AT HEEL	LENGTH OF PULL	RATE OF TWIST
SILVER RIFLED DEER MOSSY OAK BREAK-UP INFINITY												
NEW	12	22"	011386321	\$1,339.00	Rif. Bbl./Cant.	3"	7 lbs. 12 oz.	43"	1¾"	2"	14¾"	1 in 28"
NEW	20	22"	011386621	1,339.00	Rif. Bbl./Cant.	3"	6 lbs. 12 oz.	42¾"	1¾"	2¼"	14¾"	1 in 24"
SILVER RIFLED DEER STALKER												
	12	22"	011351321	\$1,199.00	Rif. Bbl./Cant.	3"	7 lbs. 12 oz.	43"	1¾"	2"	14¾"	1 in 28"
SILVER RIFLED DEER SATIN												
	20	22"	011371621	\$1,259.00	Rif. Bbl./Cant.	3"	6 lbs. 12 oz.	42¾"	1¾"	2¼"	14¾"	1 in 24"

*NOTE: Weights listed are approximate.

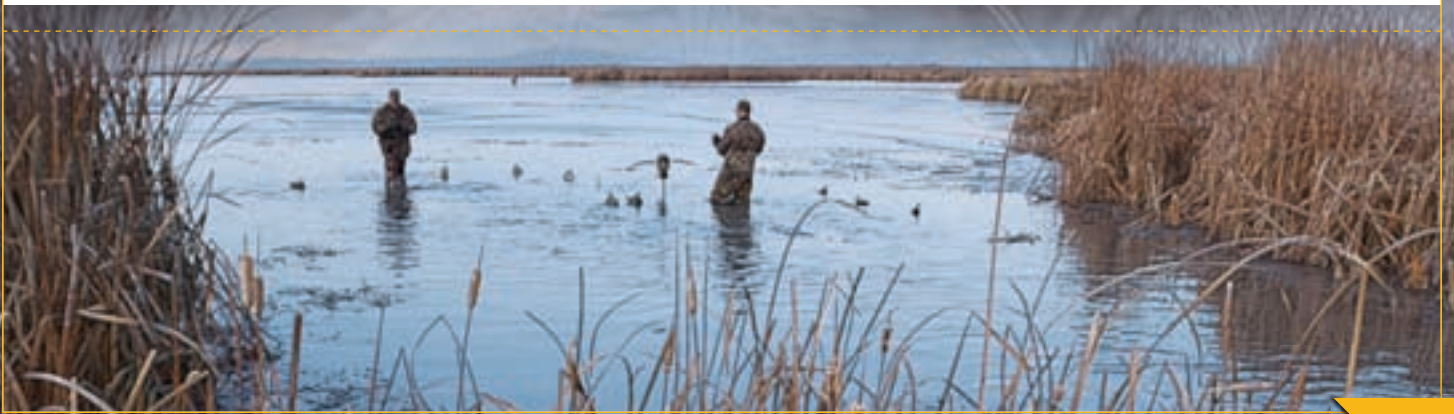

SILVER® EXTRA BARRELS

MODEL	GA.	BARREL LENGTH	CODE NUMBER	SUGG. RETAIL	CHOKES INCLUDED	CHAMBER	RATE OF TWIST
Hunter	12	28"	111350204	\$419.00	F, M, IC	3½"	—
Hunter	12	26"	111350205	419.00	F, M, IC	3½"	—
Hunter	12	30"	111350303	339.00	F, M, IC	3"	—
Hunter	12	28"	111350304	339.00	F, M, IC	3"	—
Hunter	12	26"	111350305	339.00	F, M, IC	3"	—
Hunter/Micro*	20	28"	111350604	339.00	F, M, IC	3"	—
Hunter/Micro*	20	26"	111350605	339.00	F, M, IC	3"	—
NEW Deer Satin	20	22"	111371621	419.00	Rif. Bbl./Cant.	3"	1 in 24"
Stalker	12	28"	111351204	419.00	F, M, IC	3½"	—
Stalker	12	26"	111351205	419.00	F, M, IC	3½"	—
Deer MONBU**	12	22"	111379321	539.00	Rif. Bbl./Cant.	3"	1 in 28"
NEW Deer MOINF**	12	22"	111387321	539.00	Rif. Bbl./Cant.	3"	1 in 28"
Deer Stalker**	12	22"	111380321	419.00	Rif. Bbl./Cant.	3"	1 in 28"
MONBU	12	24"	111352206	439.00	F, M, IC	3½"	—
NEW MOINF	12	24"	111384206	439.00	F, M, IC	3½"	—
MONBU	12	26"	111352205	439.00	F, M, IC	3½"	—
NEW MOINF	12	26"	111384205	439.00	F, M, IC	3½"	—
MODB	12	28"	111366204	439.00	F, M, IC	3½"	—
MODB	12	26"	111366205	439.00	F, M, IC	3½"	—

*20 gauge Silver shotgun barrels fit on Silver Hunter and Silver Micro 20 gauge models.
 **To prevent damage to forearms, all Silver rifled cantilever barrels are delivered with a new forearm specifically designed to fit over the thicker, rifled barrel walls.

GOLD® EXTRA BARRELS

MODEL	GA.	BARREL LENGTH	CODE NUMBER	SUGG. RETAIL	CHOKES INCLUDED	CHAMBER	RATE OF TWIST
GOLD 12 GA. CAMOUFLAGE EXTRA BARRELS							
MONBU	12	24"	111116206	\$524.00	XF Turkey	3½"	—
MONBU	12	22"	111116221	620.00	Rif. Bbl./Cant.	3½"	1 in 28"
MONSG	12	26"	111117305	432.00	F, M, IC	3"	—
GOLD 12 & 20 GA. EXTRA BARRELS							
Deer Hunter	12	22"	111106220	\$503.00	Rif. Bbl./Cant.	3½"	1 in 28"
Deer Hunter	12	22"	111106319	435.00	Rif. Tube/Cant.	3"	1 in 28"
Fusion	20	28"	111141604	480.00	F, M, IC	3"	—
Fusion	20	26"	111141605	480.00	F, M, IC	3"	—
GOLD 12 & 20 GA. SUPERLITE HUNTER EXTRA BARRELS							
SL Hunter	12	28"	111259204	\$492.00	F, M, IC	3½"	—
SL Hunter	12	28"	111259304	402.00	F, M, IC	3"	—
SL Hunter	12	26"	111259305	402.00	F, M, IC	3"	—
SL Hunter	20	28"	111259604	402.00	F, M, IC	3"	—
SL Hunter	20	26"	111259605	402.00	F, M, IC	3"	—
GOLD EVOLVE 12 GA. EXTRA BARRELS							
Evolve Sporting	12	30"	111262427	\$552.00	F, M, IC	2¾"	—
Evolve Sporting	12	28"	111262428	552.00	F, M, IC	2¾"	—
Evolve	12	30"	111149303	514.00	F, M, IC	3"	—
Evolve	12	28"	111149304	514.00	F, M, IC	3"	—
Evolve	12	26"	111149305	514.00	F, M, IC	3"	—
GOLD 10 GA. EXTRA BARRELS							
Hunter	10	28"	111101113	\$327.00	F, M, IC	3½"	—
Hunter	10	26"	111101114	327.00	F, M, IC	3½"	—
Stalker	10	28"	111102113	327.00	F, M, IC	3½"	—
Stalker	10	26"	111102114	327.00	F, M, IC	3½"	—
MONBU	10	28"	111137113	354.00	F, M, IC	3½"	—
NEW MOINF	10	28"	111280113	354.00	F, M, IC	3½"	—
MONBU	10	26"	111137114	354.00	F, M, IC	3½"	—
NEW MOINF	10	26"	111280114	354.00	F, M, IC	3½"	—
MONBU	10	24"	111137115	354.00	XF Turkey	3½"	—
NEW MOINF	10	24"	111280115	354.00	XF Turkey	3½"	—
MODB	10	28"	111270113	354.00	F, M, IC	3½"	—
MODB	10	26"	111270114	354.00	F, M, IC	3½"	—



NEW FOR 2010 **NEW**
 Mossy Oak Break-Up Infinity camo will be offered in conjunction with New Break-Up camo on select Browning extra barrels.

IMPORTANT: DO NOT ATTEMPT THE USE OF 3½" CHAMBERED BARRELS WITH 3" RECEIVERS NOR 3" CHAMBERED BARRELS WITH 3½" RECEIVERS.

10 GAUGE SHOTGUNS: BRING ENOUGH GUN.

Big birds like geese and turkey need a big shotgun to bring them down. When performance and pure knockdown punch really matter, Browning's impressive BPS® pump and Gold® autoloading 10 gauge shotguns are at the ready.



GOLD LIGHT 10 GAUGE ▶ GAUGE: 10 | DURA-TOUCH® ARMOR COATING



NEW FOR 2010
Mossy Oak Break-Up Infinity camo will replace New Break-Up camo on this Browning firearm.



DURA-TOUCH
Armor Coating



RECEIVER - Aluminum alloy
BARREL - Ventilated rib
ACTION - Gas-operated autoloader · 3½" chamber
MAGAZINE CAPACITY - Four in the magazine plus one in the chamber

STOCK - Composite stock and forearm · Dura-Touch® Armor Coating · Mossy Oak® camo finishes
FEATURES - Three Standard Invector™ choke tubes · NWTf model includes HiViz® 4-in-1 fiber-optic sight

BPS 10 GAUGE ▶ GAUGE: 10 | NON-GLARE COMPOSITE FINISH

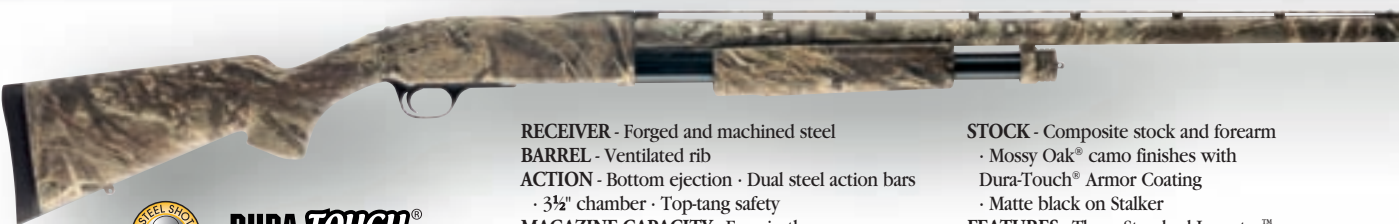

DURA-TOUCH
Armor Coating

RECEIVER - Forged and machined steel
BARREL - Ventilated rib
ACTION - Bottom ejection · Dual steel action bars · 3½" chamber · Top-tang safety
MAGAZINE CAPACITY - Four in the magazine plus one in the chamber

STOCK - Composite stock and forearm · Mossy Oak® camo finishes with Dura-Touch® Armor Coating · Matte black on Stalker
FEATURES - Three Standard Invector™ choke tubes · Brass front bead sight

NWTf BPS 10 GAUGE MOSSY OAK® BREAK-UP® INFINITY ▶ GAUGE: 10 | DURA-TOUCH® ARMOR COATING



NEW FOR 2010
Mossy Oak Break-Up Infinity camo will replace New Break-Up camo on this Browning firearm.



DURA-TOUCH
Armor Coating



RECEIVER - Forged and machined steel · Drilled and tapped for scope mounts
BARREL - Ventilated rib · 24" length
ACTION - Bottom ejection · Dual steel action bars · 3½" chamber · Top-tang safety
MAGAZINE CAPACITY - Four in the magazine plus one in the chamber
STOCK - Composite stock and forearm · Dura-Touch® Armor Coating · Mossy Oak® Break-Up® Infinity camo finish · NWTf logo

FEATURES - Standard Invector™ X-Full Turkey choke tube · HiViz® 4-in-1 fiber-optic sight · Endorsed by the National Wild Turkey Federation

	GA.	BARREL LENGTH	CODE NUMBER	SUGG. RETAIL	CHOKES INCLUDED	CHAMBER	*AVG. WEIGHT	OVERALL LENGTH	DROP AT COMB	DROP AT HEEL	LENGTH OF PULL	RIB WIDTH	
GOLD LIGHT 10 GA., MOSSY OAK BREAK-UP INFINITY AND MOSSY OAK DUCK BLIND WITH DURA-TOUCH													
NEW	MOINF	10	28"	011280113	\$1,619.00	F, M, IC	3½"	9 lbs. 10 oz.	50"	1½"	2½"	14½"	5/16"
NEW	MOINF	10	26"	011280114	1,619.00	F, M, IC	3½"	9 lbs. 9 oz.	48"	1½"	2½"	14½"	5/16"
NEW	NWTf/MOINF	10	24"	011281115	1,749.00	XF Turkey	3½"	9 lbs. 4 oz.	46"	1½"	2½"	14½"	5/16"
	MODB	10	28"	011270113	1,619.00	F, M, IC	3½"	9 lbs. 10 oz.	50"	1½"	2½"	14½"	5/16"
	MODB	10	26"	011270114	1,619.00	F, M, IC	3½"	9 lbs. 9 oz.	48"	1½"	2½"	14½"	5/16"
BPS 10 GA. STALKER													
	Stalker	10	28"	012212113	\$709.00	F, M, IC	3½"	10 lbs. 9 oz.	50"	1½"	2½"	14¼"	5/16"
	Stalker	10	26"	012212114	709.00	F, M, IC	3½"	10 lbs. 8 oz.	48"	1½"	2½"	14¼"	5/16"
BPS 10 GA., MOSSY OAK BREAK-UP INFINITY AND MOSSY OAK DUCK BLIND (SHOWN) WITH DURA-TOUCH													
NEW	MOINF	10	28"	012257113	\$839.00	F, M, IC	3½"	10 lbs. 9 oz.	50"	1½"	2½"	14¼"	5/16"
NEW	MOINF	10	26"	012257114	839.00	F, M, IC	3½"	10 lbs. 8 oz.	48"	1½"	2½"	14¼"	5/16"
	MODB	10	28"	012243113	839.00	F, M, IC	3½"	10 lbs. 9 oz.	50"	1½"	2½"	14¼"	5/16"
	MODB	10	26"	012243114	839.00	F, M, IC	3½"	10 lbs. 8 oz.	48"	1½"	2½"	14¼"	5/16"
NWTf BPS 10 GA., MOSSY OAK BREAK-UP INFINITY WITH DURA-TOUCH													
NEW	MOINF	10	24"	012258115	\$909.00	XF Turkey	3½"	10 lbs. 3 oz.	46"	1½"	2½"	14¼"	5/16"

*NOTE: Weights listed are approximate.



BPS® THE FINEST PUMP SHOTGUN AVAILABLE.

You won't find a more rugged, faster handling pump shotgun than the stalwart Browning BPS. The BPS has proven itself reliable in the rain, snow, dust and mud. They've seen tough duty in marshes, cornfields and on trap ranges. Through it all, count on the BPS to load and eject shells with ease in spite of the conditions.

BPS

TOTAL BARREL DYNAMICS

BACK-BORED BARREL TECHNOLOGY

We were the first manufacturer to recognize the advantages of a back-bored barrel. Back-boring increases the bore diameter to reduce friction between the shot cup and the barrel to maximize shot velocity and reduce felt recoil. Through intense research, our back-bore specifications have been perfected and represent the ideal bore diameter needed to minimize shot deformation and maximize pattern uniformity, consistency and density. Any larger and gases slip by the shot cup, resulting in reduced pellet velocity and blown patterns. Any smaller, and the forcing cone will deform pellets and result in poor ballistic performance, fliers and uneven, spotty pellet coverage on the target.

INVECTOR™ CHOKE TUBE SYSTEMS

The proven Invector™ (28 gauge, .410 bore) and Invector-Plus™ (12, 20 gauge) interchangeable choke tube systems come on every BPS shotgun for consistent, dense shot patterns in just the constriction needed for your shooting situation. The longer choke taper inside an Invector-Plus choke tube works hand-in-hand with Back-Bored Technology to produce consistent patterns with more uniform densities and fewer fliers. The superior design of the Invector systems are far more durable than the choke systems found in competitors' guns, especially when shooting steel shot loads. The Invector systems eliminate gases slipping between the choke tube and barrel that could damage the choke tube and the barrel. See pages 124 to 127 for a complete listing of choke tubes.

BACK-BORED TECHNOLOGY

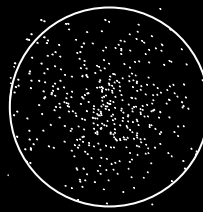

Browning pattern with Back-Bored Technology

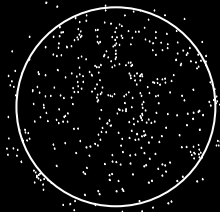

The competitors' pattern without Back-Bored Technology



STEEL SHOT PERFORMANCE

The strength of a Browning barrel is legendary, and built to handle the punishment of steel shot. Unlike some manufacturers' barrels whose guns face an uncertain future after shooting steel, we have long been at the forefront of dependable steel shot performance and durability. Our barrels meet the strictest material and construction quality standards. The barrel blanks are made from rolled and tempered steel bars and are stress relieved to offer the best mechanical properties. The barrel blanks are then precision drilled, reamed and honed to exacting specifications. With proper care, Browning BPS barrels will last a lifetime.



BOTTOM EJECTION AND LOADING

Unique bottom ejection provides operating convenience by throwing empty shells straight down, out of your line of sight, making the BPS the best pump shotgun choice for both right- and left-handed shooters.



SAFETY

The thumb-operated, top-tang safety on the BPS can easily be operated with the right or left hand, even with gloved fingers.

MAGAZINE CAPACITY

2¾": Four in magazine, one in chamber.
 3": Three in magazine, one in chamber.
 3½": Three in magazine, one in chamber.
 (A three-shot magazine adapter plug is included.)

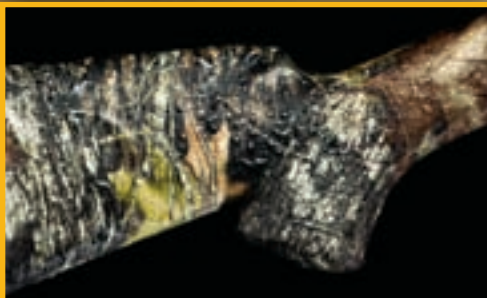

MAXIMUM GRIP

Camo composite BPS models combine in-molded checkered gripping surfaces and our proven Dura-Touch® Armor Coating for a sure hold and a sleek feel in all climate conditions.



RELIABLE PUMP-ACTION

The proven pump-action design of the BPS is sound and reliable. All components are durably constructed of solid steel and housed inside a receiver machined from a solid block of forged steel. Rigid double slide bars are made from heat-treated steel and eliminate twisting and binding for faster, more efficient operation. The BPS offers smooth operation in all conditions and gives you the ability to stay on target while delivering rapid follow-up shots. A convenient serrated slide release is located at the rear of the trigger guard.

BPS HUNTER ▶ GAUGE: 12 (SHOWN), 16, 20, 28, .410 | SATIN FINISH



RECEIVER - Forged and machined steel
 BARREL - Ventilated rib
 ACTION - Bottom ejection · Dual steel action bars · Top-tang safety

STOCK - Satin finish walnut
 FEATURES - Three Invector-Plus™ choke tubes with 12 and 20 · Three Standard Invector™ with 16, 28 and .410 · Recoil pad on 12 gauge model · Brass front bead sight



BPS UPLAND SPECIAL ▶ GAUGE: 12, 16, 20 (SHOWN) | SATIN FINISH

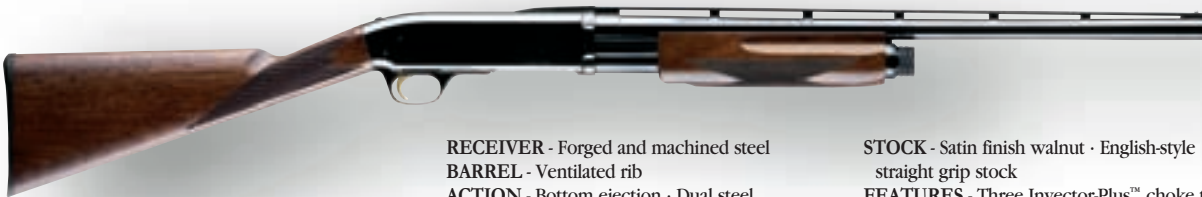

RECEIVER - Forged and machined steel
 BARREL - Ventilated rib
 ACTION - Bottom ejection · Dual steel action bars · Top-tang safety

STOCK - Satin finish walnut · English-style straight grip stock
 FEATURES - Three Invector-Plus™ choke tubes with 12 and 20 · Three Standard Invector™ with 16 · Brass front bead sight



BPS MICRO ▶ GAUGE: 20 | SATIN FINISH



BPS Micro

RECEIVER - Forged and machined steel
 BARREL - Compact 22" length · Ventilated rib
 ACTION - Bottom ejection · Dual steel action bars · Top-tang safety
 STOCK - Satin finish walnut · Compact dimensions to suit smaller shooters
 FEATURES - Three Invector-Plus™ choke tubes · Brass front bead sight



BPS Mossy Oak® Duck Blind®



GA.	BARREL LENGTH	CODE NUMBER	SUGG. RETAIL	CHOKES INCLUDED	CHAMBER	*AVG. WEIGHT	OVERALL LENGTH	DROP AT COMB	DROP AT HEEL	LENGTH OF PULL	RIB WIDTH
BPS HUNTER											
12	28"	012211304	\$599.00	F, M, IC	3"	7 lbs. 11 oz.	48¾"	1⅞"	1⅞"	14¼"	⅝"
12	26"	012211305	599.00	F, M, IC	3"	7 lbs. 10 oz.	46¾"	1⅞"	1⅞"	14¼"	⅝"
16	28"	012211513	639.00	F, M, IC	2¾"	7 lbs. 2 oz.	48¾"	1⅞"	1⅞"	14¼"	⅝"
16	26"	012211514	639.00	F, M, IC	2¾"	7 lbs. 1 oz.	46¾"	1⅞"	1⅞"	14¼"	⅝"
20	28"	012211604	599.00	F, M, IC	3"	7 lbs. 1 oz.	48¾"	1⅞"	1⅞"	14¼"	⅝"
20	26"	012211605	599.00	F, M, IC	3"	7 lbs.	46¾"	1⅞"	1⅞"	14¼"	⅝"
28	28"	012211813	639.00	F, M, IC	2¾"	7 lbs.	48¾"	1⅞"	1⅞"	14¼"	⅝"
28	26"	012211814	639.00	F, M, IC	2¾"	6 lbs. 15 oz.	46¾"	1⅞"	1⅞"	14¼"	⅝"
.410	26"	012211914	639.00	F, M, IC	3"	7 lbs.	46¾"	1⅞"	1⅞"	14¼"	⅝"
BPS UPLAND SPECIAL											
12	22"	012216307	\$599.00	F, M, IC	3"	7 lbs. 8 oz.	42½"	1⅞"	1⅞"	14"	⅝"
16	26"	012216514	639.00	F, M, IC	2¾"	6 lbs. 13 oz.	46½"	1⅞"	1⅞"	14"	⅝"
16	24"	012216515	639.00	F, M, IC	2¾"	6 lbs. 12 oz.	44½"	1⅞"	1⅞"	14"	⅝"
20	22"	012216607	599.00	F, M, IC	3"	6 lbs. 11 oz.	42½"	1⅞"	1⅞"	14"	⅝"
BPS MICRO											
20	22"	012225607	\$599.00	F, M, IC	3"	6 lbs. 14 oz.	41¾"	1⅞"	1⅞"	13¾"	⅝"

*NOTE: Weights listed are approximate.

BPS RIFLED DEER HUNTER ▶ GAUGE: 12 (SHOWN), 20 | SATIN FINISH



RECEIVER - Forged and machined steel
 BARREL - Thick-walled for slug ammunition only · Rifled, 12 gauge: 1 in 28" twist, 20 gauge: 1 in 24" twist

ACTION - Bottom ejection · Dual steel action bars · Top-tang safety
 STOCK - Satin finish walnut
 FEATURES - Cantilever scope mount

BPS MOSSY OAK® BREAK-UP® INFINITY ▶ GAUGE: 12 | DURA-TOUCH® ARMOR COATING



NEW
 NEW FOR 2010
 Mossy Oak Break-Up Infinity camo will replace New Break-Up camo on this Browning firearm.

RECEIVER - Forged and machined steel · Drilled and tapped for scope mounts
 BARREL - Ventilated rib
 ACTION - Bottom ejection · Dual steel action bars · Top-tang safety

STOCK - Composite stock and forearm · Dura-Touch® Armor Coating · Mossy Oak® Break-Up® Infinity camo finish
 FEATURES - Three Invector-Plus™ choke tubes · NWTF® models include the HiViz® 4-in-1 fiber-optic sight and buttstock decal



BPS MOSSY OAK® DUCK BLIND® ▶ GAUGE: 12 | DURA-TOUCH® ARMOR COATING



RECEIVER - Forged and machined steel
 BARREL - Ventilated rib
 ACTION - Bottom ejection · Dual steel action bars · Top-tang safety
 STOCK - Composite stock and forearm · Dura-Touch® Armor Coating · Mossy Oak® Duck Blind® camo finish
 FEATURES - Three Invector-Plus™ choke tubes · Brass front bead sight

	GA.	BARREL LENGTH	CODE NUMBER	SUGG. RETAIL	CHOKES INCLUDED	CHAMBER	*AVG. WEIGHT	OVERALL LENGTH	DROP AT COMB	DROP AT HEEL	LENGTH OF PULL	RIB WIDTH
BPS RIFLED DEER HUNTER												
	12	22"	012214324	\$739.00	Rif. Bbl./Cant.	3"	7 lbs. 10 oz.	42½"	1½"	2½"	14¼"	—
	20	22"	012214624	749.00	Rif. Bbl./Cant.	3"	7 lbs. 4 oz.	42¼"	1½"	1¾"	14¼"	—
BPS MOSSY OAK BREAK-UP INFINITY												
NEW	12	28"	012257204	\$839.00	F, M, IC	3½"	8 lbs. 5 oz.	49¼"	1½"	2½"	14¼"	5/16"
NEW	12	26"	012257205	839.00	F, M, IC	3½"	8 lbs. 4 oz.	47¼"	1½"	2½"	14¼"	5/16"
NEW NWTF	12	24"	012258206	909.00	XF Trky, M, IC	3½"	8 lbs. 3 oz.	45¼"	1½"	2½"	14¼"	5/16"
NEW	12	28"	012257304	709.00	F, M, IC	3"	8 lbs. 1 oz.	48¾"	1½"	2½"	14¼"	5/16"
NEW	12	26"	012257305	709.00	F, M, IC	3"	8 lbs.	46¾"	1½"	2½"	14¼"	5/16"
NEW NWTF	12	24"	012258306	749.00	XF Trky, M, IC	3"	7 lbs. 15 oz.	44¾"	1½"	2½"	14¼"	5/16"
BPS MOSSY OAK DUCK BLIND												
	12	28"	012243204	\$839.00	F, M, IC	3½"	8 lbs. 5 oz.	49¼"	1½"	2½"	14¼"	5/16"
	12	26"	012243205	839.00	F, M, IC	3½"	8 lbs. 4 oz.	47¼"	1½"	2½"	14¼"	5/16"
	12	28"	012243304	709.00	F, M, IC	3"	8 lbs. 1 oz.	48¾"	1½"	2½"	14¼"	5/16"
	12	26"	012243305	709.00	F, M, IC	3"	8 lbs.	46¾"	1½"	2½"	14¼"	5/16"

*NOTE: Weights listed are approximate.



BPS RIFLED DEER, MOSSY OAK® BREAK-UP® INFINITY ▶ GAUGE: 12, 20 | DURA-TOUCH® ARMOR COATING



BPS Rifled Deer, 12 gauge

DURA-TOUCH®
Armor Coating



BPS Rifled Deer, 20 gauge

DURA-TOUCH®
Armor Coating



NEW FOR 2010
Mossy Oak Break-Up Infinity camo will replace New Break-Up camo on this Browning firearm.



RECEIVER - Forged and machined steel
BARREL - Thick-walled for slug ammunition only · Rifled, 12 gauge: 1 in 28" twist, 20 gauge: 1 in 24" twist
ACTION - Bottom ejection · Dual steel action bars · Top-tang safety

STOCK - 12 gauge: composite stock and forearm, 20 gauge: wood stock and forearm · Dura-Touch® Armor Coating · Mossy Oak® Break-Up® Infinity camo finish
FEATURES - Cantilever scope mount

BPS STALKER ▶ GAUGE: 12 | NON-GLARE COMPOSITE FINISH

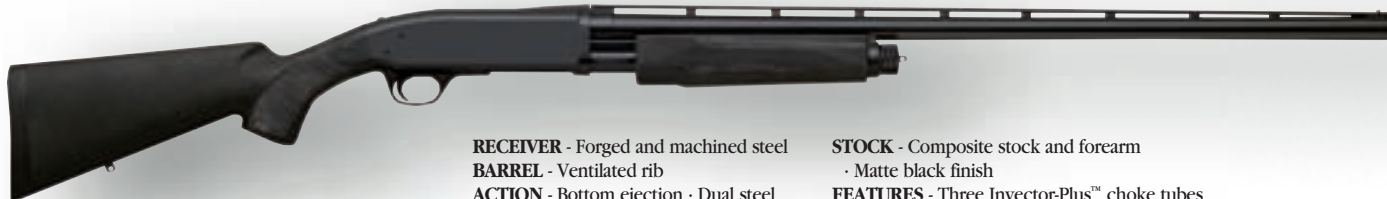

RECEIVER - Forged and machined steel
BARREL - Ventilated rib
ACTION - Bottom ejection · Dual steel action bars · Top-tang safety

STOCK - Composite stock and forearm · Matte black finish
FEATURES - Three Invector-Plus™ choke tubes · Brass front bead sight



BPS TRAP ▶ GAUGE: 12 | SATIN FINISH

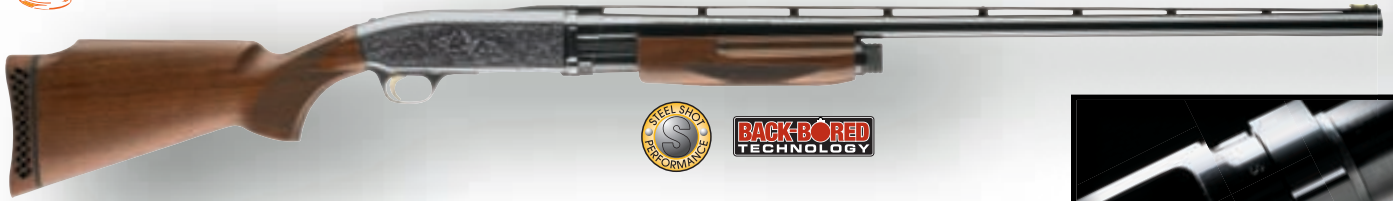

RECEIVER - Engraved · Forged and machined steel · Highly polished blue finish
BARREL - Ventilated rib
ACTION - Bottom ejection · Dual steel action bars · Top-tang safety

STOCK - Satin finish walnut · Raised comb
FEATURES - Magazine cut-off · Three Invector-Plus™ choke tubes · HiViz® ProComp fiber-optic sight with mid-bead

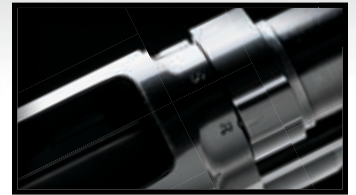

Magazine cut-off.

BPS MICRO TRAP ▶ GAUGE: 12 | SATIN FINISH



RECEIVER - Engraved · Forged and machined steel · Highly polished blue finish
BARREL - Ventilated rib
ACTION - Bottom ejection · Dual steel action bars · Top-tang safety

STOCK - Satin finish walnut · Raised comb · Compact stock dimensions to fit smaller shooters
FEATURES - Magazine cut-off · Three Invector-Plus™ choke tubes · HiViz® ProComp fiber-optic sight with mid-bead

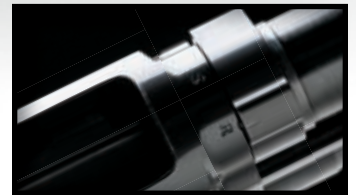

Magazine cut-off.

	GA.	BARREL LENGTH	CODE NUMBER	SUGG. RETAIL	CHOKES INCLUDED	CHAMBER	*AVG. WEIGHT	OVERALL LENGTH	DROP AT COMB	DROP AT HEEL	LENGTH OF PULL	RIB WIDTH
BPS RIFLED DEER, MOSSY OAK BREAK-UP INFINITY												
NEW	12	22"	012259324	\$759.00	Rif. Bbl./Cant.	3"	7 lbs. 10 oz.	42½"	1½"	2½"	14¾"	—
NEW	20	22"	012259624	879.00	Rif. Bbl./Cant.	3"	7 lbs. 5 oz.	42¾"	1¾"	1¾"	14¾"	—
BPS STALKER												
	12	30"	012212303	\$579.00	F, M, IC	3"	8 lbs. 2 oz.	50¾"	1½"	2½"	14¾"	⅝"
	12	28"	012212304	579.00	F, M, IC	3"	8 lbs. 1 oz.	48¾"	1½"	2½"	14¾"	⅝"
	12	26"	012212305	579.00	F, M, IC	3"	8 lbs.	46¾"	1½"	2½"	14¾"	⅝"
	12	28"	012212204	709.00	F, M, IC	3½"	8 lbs. 5 oz.	49¾"	1½"	2½"	14¾"	⅝"
	12	26"	012212205	709.00	F, M, IC	3½"	8 lbs. 4 oz.	47¾"	1½"	2½"	14¾"	⅝"
BPS TRAP												
	12	30"	012242403	\$759.00	F, IM, M	2¾"	8 lbs. 6 oz.	51"	1¾"	2"	14¾"	⅝"
BPS MICRO TRAP												
	12	28"	012241404	\$759.00	F, IM, M	2¾"	8 lbs. 1 oz.	48¾"	1¾"	2"	13¾"	⅝"

*NOTE: Weights listed are approximate.

BROWNING GROWTH INSURANCE PROGRAM

The secret is out, people get bigger. And when they do, they need a shotgun with a longer length of pull to fit their growing frame. Because shotguns are expensive, you might choose a cheaper model or those small of stature are forced to shoot a full-size firearm that will impair performance. That's why we offer the Growth Insurance Program. For a limited time, when you purchase a new BT-99 Micro, Silver Sporting Micro, BPS Micro Trap or BPS Micro you are eligible to purchase a full-size stock down the road at 50% off the retail price. That's a significant savings and allows you to purchase a shotgun of the highest quality that is guaranteed to fit and maximize shooting performance for years to come. Visit browning.com for complete details or to download a coupon for this program.



BPS® EXTRA BARRELS

MODEL	GA.	BARREL LENGTH	CODE NUMBER	SUGG. RETAIL	CHOKES INCLUDED	CHAMBER	FEATURES	RATE OF TWIST
BPS 10 GA. EXTRA BARRELS								
Hunter	10	28"	111211113	\$309.00	F, M, IC	3½"	—	—
Hunter	10	26"	111211114	309.00	F, M, IC	3½"	—	—
Hunter	10	24"	111211115	309.00	F, M, IC	3½"	—	—
Stalker	10	28"	111212113	309.00	F, M, IC	3½"	—	—
Stalker	10	26"	111212114	309.00	F, M, IC	3½"	—	—
Stalker	10	24"	111212115	309.00	F, M, IC	3½"	—	—
MONSG	10	28"	111220113	339.00	F, M, IC	3½"	—	—
MONSG	10	26"	111220114	339.00	F, M, IC	3½"	—	—
MONSG	10	24"	111220115	339.00	F, M, IC	3½"	—	—
MONBU	10	28"	111219113	339.00	F, M, IC	3½"	—	—
NEW MOINF	10	28"	111257113	339.00	F, M, IC	3½"	—	—
MONBU	10	26"	111219114	339.00	F, M, IC	3½"	—	—
NEW MOINF	10	26"	111257114	339.00	F, M, IC	3½"	—	—
MONBU	10	24"	111219115	339.00	XF Turkey	3½"	—	—
NEW MOINF	10	24"	111257115	339.00	XF Turkey	3½"	—	—
MODB	10	28"	111243113	339.00	F, M, IC	3½"	—	—
MODB	10	26"	111243114	339.00	F, M, IC	3½"	—	—
BPS 12 GA. EXTRA CAMOUFLAGE BARRELS								
MONBU	12	28"	111219204	\$339.00	F, M, IC	3½"	—	—
NEW MOINF	12	28"	111257204	339.00	F, M, IC	3½"	—	—
MONBU	12	26"	111219205	339.00	F, M, IC	3½"	—	—
NEW MOINF	12	26"	111257205	339.00	F, M, IC	3½"	—	—
MONBU	12	24"	111219206	339.00	XF Turkey	3½"	—	—
NEW MOINF	12	24"	111257206	339.00	XF Turkey	3½"	—	—
MONSG	12	28"	111220204	339.00	F, M, IC	3½"	—	—
MONSG	12	26"	111220205	339.00	F, M, IC	3½"	—	—
MONSG	12	24"	111220206	339.00	F, M, IC	3½"	—	—
MODB	12	28"	111243204	339.00	F, M, IC	3½"	—	—
MODB	12	26"	111243205	339.00	F, M, IC	3½"	—	—
MONBU	12	28"	111219304	299.00	F, M, IC	3"	—	—
NEW MOINF	12	28"	111257304	299.00	F, M, IC	3"	—	—
MONBU	12	26"	111219305	299.00	F, M, IC	3"	—	—
NEW MOINF	12	26"	111257305	299.00	F, M, IC	3"	—	—
MONBU	12	24"	111219306	299.00	XF Turkey	3"	—	—
NEW MOINF	12	24"	111257306	299.00	XF Turkey	3"	—	—
MONSG	12	28"	111220304	299.00	F, M, IC	3"	—	—
MONSG	12	26"	111220305	299.00	F, M, IC	3"	—	—
MONSG	12	24"	111220306	299.00	F, M, IC	3"	—	—
MODB	12	28"	111243304	299.00	F, M, IC	3"	—	—
MODB	12	26"	111243305	299.00	F, M, IC	3"	—	—
BPS 12 GA., 16 GA., 20 GA., 28 GA. & .410 EXTRA BARRELS								
Hunter	12	28"	111211204	\$309.00	F, M, IC	3½"	—	—
Hunter	12	26"	111211205	309.00	F, M, IC	3½"	—	—
Hunter	12	24"	111211206	309.00	F, M, IC	3½"	—	—
Hunter	12	28"	111211304	269.00	F, M, IC	3"	—	—
Hunter	12	26"	111211305	269.00	F, M, IC	3"	—	—
Hunter	12	24"	111211306	269.00	F, M, IC	3"	—	—
Hunter	16	28"	111211513	269.00	F, M, IC	2¾"	—	—
Hunter	16	26"	111211514	269.00	F, M, IC	2¾"	—	—
Hunter	20	28"	111211604	269.00	F, M, IC	3"	—	—
Hunter	20	26"	111211605	269.00	F, M, IC	3"	—	—
Hunter	20	22"	111211607	269.00	F, M, IC	3"	—	—
Hunter	28	28"	111211813	269.00	F, M, IC	2¾"	—	—
Hunter	28	26"	111211814	269.00	F, M, IC	2¾"	—	—
Hunter	.410	26"	111211914	269.00	F, M, IC	3"	—	—
Stalker	12	28"	111212204	309.00	F, M, IC	3½"	—	—
Stalker	12	26"	111212205	309.00	F, M, IC	3½"	—	—
Stalker	12	24"	111212206	309.00	F, M, IC	3½"	—	—
Stalker	12	30"	111212303	269.00	F, M, IC	3"	—	—
Stalker	12	28"	111212304	269.00	F, M, IC	3"	—	—
Stalker	12	26"	111212305	269.00	F, M, IC	3"	—	—
Stalker	12	24"	111212306	269.00	F, M, IC	3"	—	—
Upland Special	12	22"	111216307	269.00	F, M, IC	3"	—	—
BPS GAME GUN EXTRA BARRELS								
Deer Special	12	22"	111214221	\$439.00	Rif. Bbl./Cant.	3½"	Satin, Cantilever scope mount	1 in 28"
Deer Special	20	22"	111214621	399.00	Rif. Bbl./Cant.	3"	Satin, Cantilever scope mount	1 in 24"
Deer Special	12	22"	111214324	399.00	Rif. Bbl./Cant.	3"	Satin, Cantilever scope mount	1 in 28"
Turkey Special	12	20½"	111215323	319.00	Cylinder	3"	Satin, with Sight	—
Turkey Special	12	20½"	111215223	359.00	XF Turkey	3½"	Satin, with Sight	—



NEW
NEW FOR 2010
 Mossy Oak Break-Up Infinity camo will be offered in conjunction with New Break-Up camo on select Browning extra barrels.

IMPORTANT: DO NOT ATTEMPT THE USE OF 3½" CHAMBERED BARRELS WITH 3" RECEIVERS NOR 3" CHAMBERED BARRELS WITH 3½" RECEIVERS.

X-BOLT™

AWARD-WINNING INNOVATION. Winning the National Rifle Association's prestigious 2009 Golden Bullseye Award for Rifle of the Year confirmed that the Browning X-Bolt is destined for greatness. Designed for total accuracy, the X-Bolt is an integrated system of features that push the limits of factory bolt-action rifle performance, reliability and shooting comfort.

60° BOLT LIFT Short 60° bolt lift is fast cycling and allows you to work the bolt quickly without the scope getting in the way. The bolt is machined from solid steel bar stock for strength and custom rifle precision. Three locking lugs provide exceptional bolt strength.



BOLT UNLOCK BUTTON Conveniently located on top of the bolt lever, the bolt unlock button allows the bolt to be unlocked and opened with the safety in the on safe position. The bolt unlock button works in conjunction with the top-tang safety to provide an extra margin of safety when checking and unloading the chamber. The safety blocks the trigger sear and features a firing pin block for added safety.

RIFLES INDEX

A-BOLT RIFLES	45-51
A-BOLT MAGAZINES	52, 130
AUTOLOADING RIFLES	
BAR	57-62
BOSS-CR ACCESSORY	52, 130
BAR RIFLES	57-62
BAR EXTRA MAGAZINES	61, 131
BAR RECOIL PADS	61
BL-22 RIFLES	66
BLR RIFLES	53-56
BLR MAGAZINES	56, 131
BLR SCOUT MOUNT	55, 128
BUCK MARK RIFLES	68-69
CUSTOM SHOP	78-80
CENTERFIRE RIFLES	
A-Bolt	45-51
BAR	57-62
BLR	53-56
X-Bolt	39-44
LEVER-ACTION RIFLES	
BL-22	66
BLR	53-56
MAGAZINES	
A-Bolt	52, 130
BAR	61, 131
BLR	56, 131
T-Bolt Double Helix	64, 131
X-Bolt	40, 129
MOUNTS	
BLR Takedown Scout Style Scope Mount	55, 128
RECOIL PADS	
BAR	61
RIMFIRE RIFLES	
BL-22	66
Buck Mark	68-69
SA-22	67
T-Bolt	63-65
SA-22 RIFLES	67
T-BOLT RIFLES	63-65
T-BOLT DOUBLE HELIX MAGAZINES	64, 131
X-BOLT RIFLES	39-44
X-BOLT EXTRA MAGAZINES	40, 129
PISTOLS CONTENTS	
BUCK MARK	70-74
BUCK MARK MAGAZINES	70, 131
HI POWER	75-77
HI POWER 75TH ANNIVERSARY	75
HI POWER MAGAZINES	77, 131

X-BOLT™

FEATHERTRIGGER™

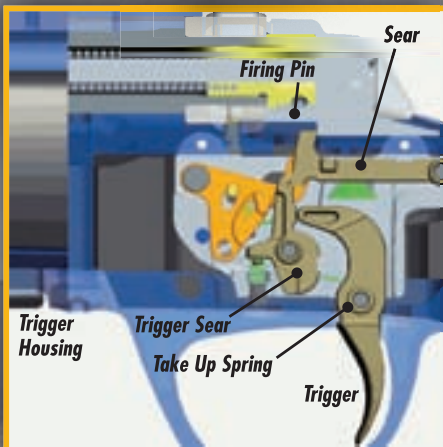

Full sear engagement (Ready to fire)

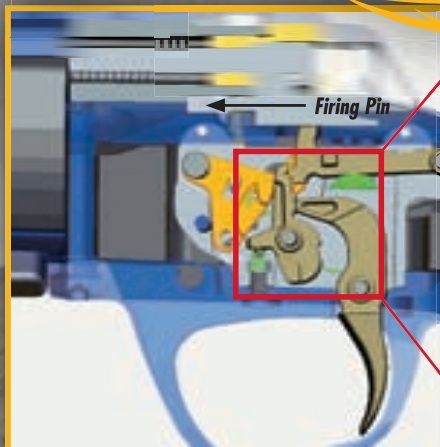

Unseared (Fired)

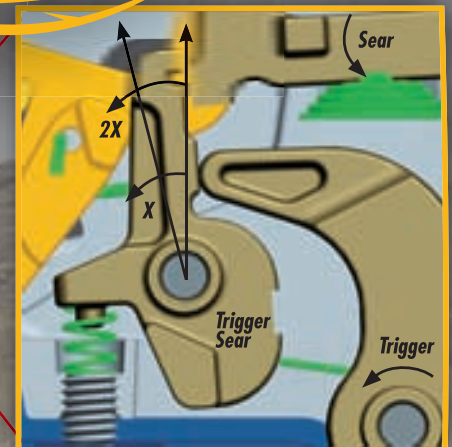

Close-up of unseared (Fired)

For precise shooting there is absolutely no substitute for a crisp, predictable trigger. The X-Bolt's three-lever Feather Trigger™ provides a clean, crisp pull with no take-up or creep and minimal overtravel. The trigger is screw adjustable from 3 to 5 lbs. and factory pre-set at approximately 3½ lbs. An alloy trigger housing contains the hard chromed steel components that are highly polished on all critical contact surfaces. Precise engagement angles mean the X-Bolt Feather Trigger feels light and right and stays that way through many thousands of rounds. Unlike competitors' triggers that rely on a secondary fingerpiece lever, the Feather Trigger is designed right, from the very start.



X-LOCK™ SCOPE MOUNTING SYSTEM

Securely mounted optics are essential for accuracy and precision on any rifle. To ensure the X-Bolt has the most stable scope mounting system possible, the X-Lock mounts feature an all new four screw per base design that replaces the traditional two screw system. The benefits are obvious, with the bases secured at all four corners, rather than only attached at the center of the base for more accurate placement on the receiver. See page 129 for more details on the new X-Lock Scope Mounting System.

All Browning firearms are shipped with a free locking device to assist in the safe storage of firearms.

INFLEX TECHNOLOGY RECOIL PAD

The Inflex Technology recoil pad is standard on every X-Bolt rifle. This ultra soft pad offers the best recoil absorption available on any rifle. The proprietary construction and material promote a directional deflection of recoil forces, pulling the stock comb away from your face to reduce felt recoil and muzzle climb.



MAXIMUM GRIP

Composite X-Bolt models combine in-molded textured gripping surfaces and Browning's proven Dura-Touch® Armor Coating for a sure hold and a sleek feel in all climate conditions.



MAGAZINE

A detachable rotary magazine is incorporated into the X-Bolt. Constructed from a durable lightweight polymer, the magazine is designed to feed cartridges directly in-line with the bolt, instead of offset as with traditional leaf-spring magazines, for a straight shot right into the chamber.

An ergonomic magazine-mounted release lets the magazine rotate directly downward and into your hand. The magazine sits flush with the bottom of the rifle for a sleeker appearance. Additional magazines can be kept loaded and carried for easy access.



BARREL

A free-floating barrel is essential for utmost accuracy. The X-Bolt is free-floated by bedding the front and rear of the action for stability. This maintains barrel to stock spacing for consistent accuracy. A recessed muzzle crown helps protect the rifling from damage. Barrels are triple checked for interior finish, straightness and air-gauged for uniformity.

X-BOLT EXTRA MAGAZINES

CALIBER	CODE NUMBER	SUGG. RETAIL
Long Action Magnum: 338 Win. Mag., 300 Win. Mag., 7mm Rem. Mag.	112044601	\$49.99
Long Action Standard: 30-06 Sprg., 280 Rem., 270 Win., 25-06 Rem.	112044602	49.99
Short Action Magnum: 325 WSM, 300 WSM, 7mm WSM, 270 WSM	112044603	49.99
Short Action Standard: 308 Win., 7mm-08 Rem., 243 Win.	112044604	49.99
Super-Short Action Standard: 22-250 Rem.	112044009	49.99
Super-Short Action Standard: 223 Rem.	112044008	49.99
Large Magnum Calibers: 375 H&H Mag.	112044606	49.99

X-BOLT WHITE GOLD ▶ GLOSS FINISH

NEW

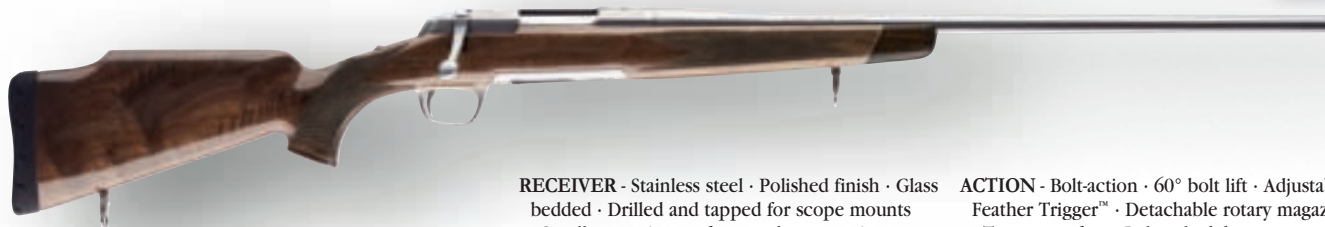

RECEIVER - Stainless steel · Polished finish · Glass bedded · Drilled and tapped for scope mounts · Scroll engraving on front and rear receiver
BARREL - Stainless steel · Polished stainless finish · Free-floating · Hand chambered · Target crown

ACTION - Bolt-action · 60° bolt lift · Adjustable Feather Trigger™ · Detachable rotary magazine · Top-tang safety · Bolt unlock button
STOCK - Gloss finish checkered walnut stock · Rosewood fore-end grip and pistol grip cap
FEATURES - Sling swivel studs installed · Inflex Technology recoil pad

X-BOLT MEDALLION ▶ GLOSS FINISH



RECEIVER - Steel · Engraved with blued finish · Glass bedded · Drilled and tapped for scope mounts
BARREL - Blued finish · Free-floating · Hand chambered · Target crown
ACTION - Bolt-action · 60° bolt lift · Adjustable Feather Trigger™ · Detachable rotary magazine · Top-tang safety · Bolt unlock button

STOCK - Gloss finish checkered walnut stock · Rosewood fore-end grip and pistol grip cap
FEATURES - Sling swivel studs installed · Inflex Technology recoil pad



(SSA) = Super-Short Action, (SA) = Short Action, (LA) = Long Action

	CALIBER	BARREL LENGTH	CODE NUMBER	SUGG. RETAIL	*TOTAL CAPACITY	**AVG. WEIGHT	OVERALL LENGTH	SIGHT RADIUS	***DROP AT COMB	DROP AT HEEL	LENGTH OF PULL	RATE OF TWIST
X-BOLT WHITE GOLD												
NEW	(SA) 243 Win.	22"	035235211	\$1,439.00	5	6 lbs. 8 oz.	41¾"	—	⅝"	½"	13⅝"	1 in 10"
NEW	(SA) 7mm-08 Rem.	22"	035235216	1,439.00	5	6 lbs. 8 oz.	41¾"	—	⅝"	½"	13⅝"	1 in 9½"
NEW	(SA) 308 Win.	22"	035235218	1,439.00	5	6 lbs. 8 oz.	41¾"	—	⅝"	½"	13⅝"	1 in 12"
NEW	(SA) 270 WSM	23"	035235248	1,469.00	4	6 lbs. 11 oz.	42¾"	—	⅝"	½"	13⅝"	1 in 10"
NEW	(SA) 7mm WSM	23"	035235249	1,469.00	4	6 lbs. 11 oz.	42¾"	—	⅝"	½"	13⅝"	1 in 9½"
NEW	(SA) 300 WSM	23"	035235246	1,469.00	4	6 lbs. 11 oz.	42¾"	—	⅝"	½"	13⅝"	1 in 10"
NEW	(SA) 325 WSM	23"	035235277	1,469.00	4	6 lbs. 11 oz.	42¾"	—	⅝"	½"	13⅝"	1 in 10"
NEW	(LA) 25-06 Rem.	24"	035235223	1,439.00	5	6 lbs. 14 oz.	44¾"	—	⅝"	½"	13⅝"	1 in 10"
NEW	(LA) 270 Win.	22"	035235224	1,439.00	5	6 lbs. 12 oz.	42¾"	—	⅝"	½"	13⅝"	1 in 10"
NEW	(LA) 280 Rem.	22"	035235225	1,439.00	5	6 lbs. 12 oz.	42¾"	—	⅝"	½"	13⅝"	1 in 10"
NEW	(LA) 30-06 Sprg.	22"	035235226	1,439.00	5	6 lbs. 12 oz.	42¾"	—	⅝"	½"	13⅝"	1 in 10"
NEW	(LA) 7mm Rem. Mag.	26"	035235227	1,469.00	4	7 lbs.	46¾"	—	⅝"	½"	13⅝"	1 in 9½"
NEW	(LA) 300 Win. Mag.	26"	035235229	1,469.00	4	7 lbs.	46¾"	—	⅝"	½"	13⅝"	1 in 10"
NEW	(LA) 338 Win. Mag.	26"	035235231	1,469.00	4	7 lbs.	46¾"	—	⅝"	½"	13⅝"	1 in 10"
X-BOLT MEDALLION												
	(SSA) 223 Rem.	22"	035204208	\$1,019.00	6	6 lbs. 6 oz.	41¼"	—	⅝"	½"	13⅝"	1 in 12"
	(SSA) 22-250 Rem.	22"	035204209	1,019.00	5	6 lbs. 6 oz.	41¼"	—	⅝"	½"	13⅝"	1 in 14"
	(SA) 243 Win.	22"	035200211	1,019.00	5	6 lbs. 8 oz.	41¾"	—	⅝"	½"	13⅝"	1 in 10"
	(SA) 308 Win.	22"	035200218	1,019.00	5	6 lbs. 8 oz.	41¾"	—	⅝"	½"	13⅝"	1 in 12"
	(SA) 270 WSM	23"	035200248	1,039.00	4	6 lbs. 11 oz.	42¾"	—	⅝"	½"	13⅝"	1 in 10"
	(SA) 7mm WSM	23"	035200249	1,039.00	4	6 lbs. 11 oz.	42¾"	—	⅝"	½"	13⅝"	1 in 9½"
	(SA) 300 WSM	23"	035200246	1,039.00	4	6 lbs. 11 oz.	42¾"	—	⅝"	½"	13⅝"	1 in 10"
	(SA) 325 WSM	23"	035200277	1,039.00	4	6 lbs. 11 oz.	42¾"	—	⅝"	½"	13⅝"	1 in 10"
	(LA) 25-06 Rem.	24"	035200223	1,019.00	5	6 lbs. 14 oz.	44¾"	—	⅝"	½"	13⅝"	1 in 10"
	(LA) 270 Win.	22"	035200224	1,019.00	5	6 lbs. 12 oz.	42¾"	—	⅝"	½"	13⅝"	1 in 10"
	(LA) 280 Rem.	22"	035200225	1,019.00	5	6 lbs. 12 oz.	42¾"	—	⅝"	½"	13⅝"	1 in 10"
	(LA) 30-06 Sprg.	22"	035200226	1,019.00	5	6 lbs. 12 oz.	42¾"	—	⅝"	½"	13⅝"	1 in 10"
	(LA) 7mm Rem. Mag.	26"	035200227	1,039.00	4	7 lbs.	46¾"	—	⅝"	½"	13⅝"	1 in 9½"
	(LA) 300 Win. Mag.	26"	035200229	1,039.00	4	7 lbs.	46¾"	—	⅝"	½"	13⅝"	1 in 10"
	(LA) 338 Win. Mag.	26"	035200231	1,039.00	4	7 lbs.	46¾"	—	⅝"	½"	13⅝"	1 in 10"

NOTE: **Total capacity includes one round in the chamber. ***Weights listed are approximate. ****Measured from centerline of bore.

X-BOLT HUNTER ▶ SATIN FINISH



- RECEIVER - Steel · Low-luster blued finish · Glass bedded · Drilled and tapped for scope mounts
- BARREL - Low-luster blued finish · Free-floating · Hand chambered · Target crown
- ACTION - Bolt-action · 60° bolt lift · Adjustable Feather Trigger™ · Detachable rotary magazine · Top-tang safety · Bolt unlock button
- STOCK - Satin finish checkered walnut stock
- FEATURES - Sling swivel studs installed · Inflex Technology recoil pad · Scope and mounts not included

THE X-BOLT — TOTAL ACCURACY.

Every part of the Browning X-Bolt works with the other to provide a complete package that delivers total accuracy. From the crisp Feather Trigger to the center-feed rotary magazine to the X-Lock system to the comfortable stock design with Inflex recoil pad, everything combines to maximize the accuracy potential of the X-Bolt.

X-BOLT MICRO HUNTER ▶ SATIN FINISH



- RECEIVER - Steel · Low-luster blued finish · Glass bedded · Drilled and tapped for scope mounts
- BARREL - Low-luster blued finish · Free-floating · Hand chambered · Target crown
- ACTION - Bolt-action · 60° bolt lift · Adjustable Feather Trigger™ · Detachable rotary magazine · Top-tang safety · Bolt unlock button

- STOCK - Satin finish checkered walnut stock · Sized for smaller shooters
- FEATURES - Sling swivel studs installed · Inflex Technology recoil pad · Scope and mounts not included

(SSA) = Super-Short Action, (SA) = Short Action, (LA) = Long Action

CALIBER	BARREL LENGTH	CODE NUMBER	SUGG. RETAIL	*TOTAL CAPACITY	**AVG. WEIGHT	OVERALL LENGTH	SIGHT RADIUS	***DROP AT COMB	DROP AT HEEL	LENGTH OF PULL	RATE OF TWIST
X-BOLT HUNTER											
(SSA) 223 Rem.	22"	035209208	\$899.00	6	6 lbs. 6 oz.	41¼"	—	⅝"	½"	13⅝"	1 in 12"
(SSA) 22-250 Rem.	22"	035209209	899.00	5	6 lbs. 6 oz.	41¼"	—	⅝"	½"	13⅝"	1 in 14"
(SA) 243 Win.	22"	035208211	899.00	5	6 lbs. 8 oz.	41¾"	—	⅝"	½"	13⅝"	1 in 10"
(SA) 7mm-08 Rem.	22"	035208216	899.00	5	6 lbs. 8 oz.	41¾"	—	⅝"	½"	13⅝"	1 in 9½"
(SA) 308 Win.	22"	035208218	899.00	5	6 lbs. 8 oz.	41¾"	—	⅝"	½"	13⅝"	1 in 12"
(SA) 270 WSM	23"	035208248	939.00	4	6 lbs. 11 oz.	42¾"	—	⅝"	½"	13⅝"	1 in 10"
(SA) 7mm WSM	23"	035208249	939.00	4	6 lbs. 11 oz.	42¾"	—	⅝"	½"	13⅝"	1 in 9½"
(SA) 300 WSM	23"	035208246	939.00	4	6 lbs. 11 oz.	42¾"	—	⅝"	½"	13⅝"	1 in 10"
(SA) 325 WSM	23"	035208277	939.00	4	6 lbs. 11 oz.	42¾"	—	⅝"	½"	13⅝"	1 in 10"
(LA) 25-06 Rem.	24"	035208223	899.00	5	6 lbs. 14 oz.	44¾"	—	⅝"	½"	13⅝"	1 in 10"
(LA) 270 Win.	22"	035208224	899.00	5	6 lbs. 12 oz.	42¾"	—	⅝"	½"	13⅝"	1 in 10"
(LA) 280 Rem.	22"	035208225	899.00	5	6 lbs. 12 oz.	42¾"	—	⅝"	½"	13⅝"	1 in 10"
(LA) 30-06 Sprg.	22"	035208226	899.00	5	6 lbs. 12 oz.	42¾"	—	⅝"	½"	13⅝"	1 in 10"
(LA) 7mm Rem. Mag.	26"	035208227	939.00	4	7 lbs.	46¾"	—	⅝"	½"	13⅝"	1 in 9½"
(LA) 300 Win. Mag.	26"	035208229	939.00	4	7 lbs.	46¾"	—	⅝"	½"	13⅝"	1 in 10"
(LA) 338 Win. Mag.	26"	035208231	939.00	4	7 lbs.	46¾"	—	⅝"	½"	13⅝"	1 in 10"
X-BOLT MICRO HUNTER											
(SSA) 22-250 Rem.	20"	035216209	\$899.00	5	5 lbs. 15 oz.	39"	—	⅝"	½"	13⅝"	1 in 14"
(SA) 243 Win.	20"	035215211	899.00	5	6 lbs. 2 oz.	39½"	—	⅝"	½"	13⅝"	1 in 10"
(SA) 7mm-08 Rem.	20"	035215216	899.00	5	6 lbs. 2 oz.	39½"	—	⅝"	½"	13⅝"	1 in 9½"
(SA) 308 Win.	20"	035215218	899.00	5	6 lbs. 2 oz.	39½"	—	⅝"	½"	13⅝"	1 in 12"
(SA) 270 WSM	22"	035215248	919.00	4	6 lbs. 7 oz.	41½"	—	⅝"	½"	13⅝"	1 in 10"
(SA) 7mm WSM	22"	035215249	919.00	4	6 lbs. 7 oz.	41½"	—	⅝"	½"	13⅝"	1 in 9½"
(SA) 300 WSM	22"	035215246	919.00	4	6 lbs. 7 oz.	41½"	—	⅝"	½"	13⅝"	1 in 10"
(SA) 325 WSM	22"	035215277	919.00	4	6 lbs. 7 oz.	41½"	—	⅝"	½"	13⅝"	1 in 10"

NOTE: *Total capacity includes one round in the chamber. **Weights listed are approximate. ***Measured from centerline of bore.

X-BOLT COMPOSITE STALKER ▶ DURA-TOUCH® ARMOR COATING



RECEIVER - Steel · Matte blued finish
 · Glass bedded · Drilled and tapped for scope mounts
BARREL - Matte blued finish · Free-floating
 · Hand chambered · Target crown
ACTION - Bolt-action · 60° bolt lift · Adjustable Feather Trigger™ · Detachable rotary magazine
 · Top-tang safety · Bolt unlock button

STOCK - Composite · Textured gripping surfaces · Palm swell
 · Matte black · Dura-Touch® Armor Coating
FEATURES - Sling swivel studs installed · Inflex Technology recoil pad · Scope and mounts not included

X-BOLT STAINLESS STALKER ▶ DURA-TOUCH® ARMOR COATING



RECEIVER - Stainless steel · Matte finish · Glass bedded · Drilled and tapped for scope mounts
BARREL - Stainless steel · Matte finish · Free-floating
 · Hand chambered · Target crown
ACTION - Bolt-action · 60° bolt lift · Adjustable Feather Trigger™ · Detachable rotary magazine
 · Top-tang safety · Bolt unlock button

STOCK - Composite · Textured gripping surfaces · Palm swell
 · Matte black · Dura-Touch® Armor Coating
FEATURES - Sling swivel studs installed · Inflex Technology recoil pad · Scope and mounts not included

(SSA) = Super-Short Action, (SA) = Short Action, (LA) = Long Action

CALIBER	BARREL LENGTH	CODE NUMBER	SUGG. RETAIL	*TOTAL CAPACITY	**AVG. WEIGHT	OVERALL LENGTH	SIGHT RADIUS	***DROP AT COMB	DROP AT HEEL	LENGTH OF PULL	RATE OF TWIST
X-BOLT COMPOSITE STALKER											
(SSA) 223 Rem.	22"	035205208	\$899.00	6	6 lbs. 3 oz.	41¼"	—	⅝"	½"	13⅝"	1 in 12"
(SSA) 22-250 Rem.	22"	035205209	899.00	5	6 lbs. 3 oz.	41¼"	—	⅝"	½"	13⅝"	1 in 14"
(SA) 243 Win.	22"	035201211	899.00	5	6 lbs. 5 oz.	41¾"	—	⅝"	½"	13⅝"	1 in 10"
(SA) 7mm-08 Rem.	22"	035201216	899.00	5	6 lbs. 5 oz.	41¾"	—	⅝"	½"	13⅝"	1 in 9½"
(SA) 308 Win.	22"	035201218	899.00	5	6 lbs. 5 oz.	41¾"	—	⅝"	½"	13⅝"	1 in 12"
(SA) 270 WSM	23"	035201248	939.00	4	6 lbs. 8 oz.	42¾"	—	⅝"	½"	13⅝"	1 in 10"
(SA) 7mm WSM	23"	035201249	939.00	4	6 lbs. 8 oz.	42¾"	—	⅝"	½"	13⅝"	1 in 9½"
(SA) 300 WSM	23"	035201246	939.00	4	6 lbs. 8 oz.	42¾"	—	⅝"	½"	13⅝"	1 in 10"
(SA) 325 WSM	23"	035201277	939.00	4	6 lbs. 8 oz.	42¾"	—	⅝"	½"	13⅝"	1 in 10"
(LA) 25-06 Rem.	24"	035201223	899.00	5	6 lbs. 11 oz.	44¾"	—	⅝"	½"	13⅝"	1 in 10"
(LA) 270 Win.	22"	035201224	899.00	5	6 lbs. 9 oz.	42¾"	—	⅝"	½"	13⅝"	1 in 10"
(LA) 280 Rem.	22"	035201225	899.00	5	6 lbs. 9 oz.	42¾"	—	⅝"	½"	13⅝"	1 in 10"
(LA) 30-06 Sprg.	22"	035201226	899.00	5	6 lbs. 9 oz.	42¾"	—	⅝"	½"	13⅝"	1 in 10"
(LA) 7mm Rem. Mag.	26"	035201227	939.00	4	6 lbs. 13 oz.	46¾"	—	⅝"	½"	13⅝"	1 in 9½"
(LA) 300 Win. Mag.	26"	035201229	939.00	4	6 lbs. 13 oz.	46¾"	—	⅝"	½"	13⅝"	1 in 10"
(LA) 338 Win. Mag.	26"	035201231	939.00	4	6 lbs. 13 oz.	46¾"	—	⅝"	½"	13⅝"	1 in 10"
X-BOLT STAINLESS STALKER											
(SSA) 223 Rem.	22"	035206208	\$1,119.00	6	6 lbs. 3 oz.	41¼"	—	⅝"	½"	13⅝"	1 in 12"
(SSA) 22-250 Rem.	22"	035206209	1,119.00	5	6 lbs. 3 oz.	41¼"	—	⅝"	½"	13⅝"	1 in 14"
(SA) 243 Win.	22"	035202211	1,119.00	5	6 lbs. 5 oz.	41¾"	—	⅝"	½"	13⅝"	1 in 10"
(SA) 7mm-08 Rem.	22"	035202216	1,119.00	5	6 lbs. 5 oz.	41¾"	—	⅝"	½"	13⅝"	1 in 9½"
(SA) 308 Win.	22"	035202218	1,119.00	5	6 lbs. 5 oz.	41¾"	—	⅝"	½"	13⅝"	1 in 12"
(SA) 270 WSM	23"	035202248	1,149.00	4	6 lbs. 8 oz.	42¾"	—	⅝"	½"	13⅝"	1 in 10"
(SA) 7mm WSM	23"	035202249	1,149.00	4	6 lbs. 8 oz.	42¾"	—	⅝"	½"	13⅝"	1 in 9½"
(SA) 300 WSM	23"	035202246	1,149.00	4	6 lbs. 8 oz.	42¾"	—	⅝"	½"	13⅝"	1 in 10"
(SA) 325 WSM	23"	035202277	1,149.00	4	6 lbs. 8 oz.	42¾"	—	⅝"	½"	13⅝"	1 in 10"
(LA) 25-06 Rem.	24"	035202223	1,119.00	5	6 lbs. 11 oz.	44¾"	—	⅝"	½"	13⅝"	1 in 10"
(LA) 270 Win.	22"	035202224	1,119.00	5	6 lbs. 9 oz.	42¾"	—	⅝"	½"	13⅝"	1 in 10"
(LA) 280 Rem.	22"	035202225	1,119.00	5	6 lbs. 9 oz.	42¾"	—	⅝"	½"	13⅝"	1 in 10"
(LA) 30-06 Sprg.	22"	035202226	1,119.00	5	6 lbs. 9 oz.	42¾"	—	⅝"	½"	13⅝"	1 in 10"
(LA) 7mm Rem. Mag.	26"	035202227	1,149.00	4	6 lbs. 13 oz.	46¾"	—	⅝"	½"	13⅝"	1 in 9½"
(LA) 300 Win. Mag.	26"	035202229	1,149.00	4	6 lbs. 13 oz.	46¾"	—	⅝"	½"	13⅝"	1 in 10"
(LA) 338 Win. Mag.	26"	035202231	1,149.00	4	6 lbs. 13 oz.	46¾"	—	⅝"	½"	13⅝"	1 in 10"

NOTE: *Total capacity includes one round in the chamber. **Weights listed are approximate. ***Measured from centerline of bore.

X-BOLT VARMINT STALKER ▶ DURA-TOUCH® ARMOR COATING



X-BOLT RMEF® WHITE GOLD ▶ GLOSS FINISH



RMEF Logo Grip Cap

X-BOLT RMEF® SPECIAL HUNTER ▶ SATIN FINISH



X-BOLT VARMINT STALKER

RECEIVER - Steel · Matte blued finish
· Glass bedded · Drilled and tapped for scope mounts
BARREL - Medium heavy · Matte blued finish · Free-floating
· Hand chambered · Target crown

ACTION - Bolt-action · 60° bolt lift · Adjustable Feather Trigger™ · Detachable rotary magazine
· Top-tang safety · Bolt unlock button
STOCK - Composite · Textured gripping surfaces
· Palm swell · Matte black · Dura-Touch® Armor Coating
FEATURES - Sling swivel studs installed
· Inflex Technology recoil pad

X-BOLT RMEF WHITE GOLD

RECEIVER - Stainless steel · Gold engraved with low luster finish
· Glass bedded · Drilled and tapped for scope mounts
BARREL - Stainless steel · Low luster finish · Free-floating · Hand chambered · Target crown

ACTION - Bolt-action · 60° bolt lift · Adjustable Feather Trigger™ · Detachable rotary magazine
· Top-tang safety · Bolt unlock button
STOCK - Select gloss finish walnut
· Raised cheekpiece · Checkered · Rosewood grip and forearm caps · RMEF logo inset grip cap
FEATURES - Sling swivel studs installed
· Recoil pad

X-BOLT RMEF SPECIAL HUNTER

RECEIVER - Steel · Low-luster blued finish · Glass bedded · Drilled and tapped for scope mounts
BARREL - Matte blued finish
· Free-floating · Hand chambered
· Target crown

ACTION - Bolt-action · 60° bolt lift · Adjustable Feather Trigger™ · Detachable rotary magazine
· Top-tang safety · Bolt unlock button
STOCK - Satin finish walnut · Raised cheekpiece
· Checkered · Rosewood grip cap
· RMEF logo inset grip cap
FEATURES - Sling swivel studs installed
· Inflex Technology recoil pad



(SSA) = Super-Short Action, (SA) = Short Action, (LA) = Long Action

	CALIBER	BARREL LENGTH	CODE NUMBER	SUGG. RETAIL	*TOTAL CAPACITY	**AVG. WEIGHT	OVERALL LENGTH	SIGHT RADIUS	***DROP AT COMB	DROP AT HEEL	LENGTH OF PULL	RATE OF TWIST
X-BOLT VARMINT STALKER												
	(SSA) 223 Rem.	24"	035207208	\$1,079.00	6	7 lbs. 15 oz.	43¼"	—	5/8"	½"	13¾"	1 in 12"
	(SSA) 22-250 Rem.	26"	035207209	1,079.00	5	8 lbs. 2 oz.	45¼"	—	5/8"	½"	13¾"	1 in 14"
	(SA) 243 Win.	24"	035203211	1,079.00	5	8 lbs. 1 oz.	43¾"	—	5/8"	½"	13¾"	1 in 10"
	(SA) 308 Win.	24"	035203218	1,079.00	5	8 lbs. 1 oz.	43¾"	—	5/8"	½"	13¾"	1 in 12"
X-BOLT RMEF WHITE GOLD												
	(SA) 325 WSM	23"	035217277	\$1,599.00	4	7 lbs. 3 oz.	42¾"	—	15/16"	1¼"	13¾"	1 in 10"
X-BOLT RMEF SPECIAL HUNTER												
	(SA) 325 WSM	23"	035218277	\$979.00	4	6 lbs. 14 oz.	42¾"	—	15/16"	1¼"	13¾"	1 in 10"

NOTE: *Total capacity includes one round in the chamber. **Weights listed are approximate. ***Measured from centerline of bore.

A-BOLT

25TH

ANNIVERSARY

A-BOLT® — THE STANDARD FOR ACCURACY.

With a reputation of outstanding accuracy and reliable performance, the versatile Browning A-Bolt rifle has put a smile on the face of thousands of hunters and shooters. It is this legacy, along with impeccable manufacturing and finish quality, that keeps the A-Bolt going strong. For even greater accuracy pair the A-Bolt with the proven BOSS® System that predictably tunes barrel harmonics to precisely match the ammunition used.

SPECIAL ENGRAVING

To commemorate the 25th anniversary of the introduction of the A-Bolt, select A-Bolt rifles produced in 2010 (in limited quantities) will be adorned with this special engraving on the floorplate.



Script

Block

PERSONALIZED ENGRAVING

The bolt of the A-Bolt rifle can be personalized with your name. Call (800) 333-3288. Not available on the Mountain Ti model.

All Browning firearms are shipped with a free locking device to assist in the safe storage of firearms.

BOLT-ACTION

With a short 60° lift, the bolt incorporates a non-rotating bolt sleeve that runs the full length of the bolt. When unlocked, three guide ribs on the bolt sleeve align with the three locking lugs to allow the bolt to slide smoothly. When locked, these three lugs provide massive bolt strength. The A-Bolt feeds smoothly because of its unique, patented cartridge depressor. This cartridge depressor stays in position, independent of the bolt rotation, as the bolt slides gently over the cartridges in the magazine. The bolt face is recessed, completely surrounding the cartridge base.



MAGAZINE

Hinged floorplate with detachable box magazine makes it simple and fast to load a spare magazine.

MAGAZINE CAPACITY

Three in magazine, one in chamber. Standard calibers: Four in magazine, one in chamber.
223 Rem. : Five in magazine, one in chamber.



THE BOSS® SYSTEM

The Ballistic Optimizing Shooting System is designed to squeeze maximum accuracy from the A-Bolt. The tunable BOSS System easily dials-in barrel harmonics to precisely match the specific ammunition being fired, resulting in amazingly tight groups. The BOSS System is available as an option on the Medallion, Composite Stalker, Stainless Stalker, M-1000 Eclipse and Stainless M-1000 Eclipse. An interchangeable, non-ported BOSS-CR is also included.

BOSS-CR

This accessory is also included with all BOSS-equipped A-Bolt rifles and offers all the accuracy advantages of the original BOSS without the muzzle brake feature.



BEDDED ACTION AND FREE-FLOATED BARREL

The barrel is free-floating and the action is glass bedded at the recoil lug and at the front of the receiver to maintain the proper spacing around the barrel for consistent accuracy. Every A-Bolt features a recessed muzzle crown to protect the rifling. Barrels are hand chambered and triple checked for interior finish, straightness and air-gauged for uniformity.



A-BOLT MOUNTAIN Ti ▶ DURA-TOUCH® ARMOR COATING



NEW FOR 2010
Also available in Mossy Oak Break-Up Infinity camo.

NEW



DURA-TOUCH®
Armor Coating



RECEIVER - Titanium · Matte finish · Glass bedded · Drilled and tapped for scope mounts
BARREL - Stainless steel · Matte finish · Free-floating · Hand chambered · Target crown
ACTION - Bolt-action · 60° bolt lift · Stainless steel bolt face with composite bolt sleeve · Adjustable trigger · Detachable box magazine · Hinged floorplate · Top-tang safety

STOCK - Bell and Carlson™ synthetic (magnum calibers include aluminium bedding block for added strength)
 · Dura-Touch® Armor Coating
 · Mossy Oak® camo finishes
FEATURES - Sling swivel studs installed · Pachmayr® Decelerator® recoil pad

A-BOLT HUNTER, LEFT-HAND ▶ SATIN FINISH

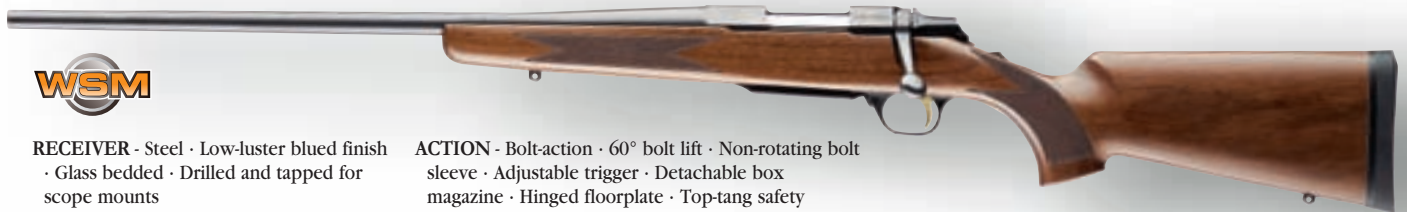

RECEIVER - Steel · Low-luster blued finish · Glass bedded · Drilled and tapped for scope mounts
BARREL - Low-luster blued finish · Free floating · Hand chambered · Target crown

ACTION - Bolt-action · 60° bolt lift · Non-rotating bolt sleeve · Adjustable trigger · Detachable box magazine · Hinged floorplate · Top-tang safety
STOCK - Satin finish walnut · Checkered
FEATURES - Sling swivel studs installed · Recoil pad

A-BOLT HUNTER, FULL LINE DEALER ▶ SATIN FINISH



RECEIVER - Steel · Low-luster blued finish · Glass bedded · Drilled and tapped for scope mounts
BARREL - Low-luster blued finish · Free-floating · Hand chambered · Target crown

ACTION - Bolt-action · 60° bolt lift · Non-rotating bolt sleeve · Adjustable trigger · Detachable box magazine · Hinged floorplate · Top-tang safety
STOCK - Satin finish walnut · Raised cheekpiece · Checkered
FEATURES - Sling swivel studs installed · Recoil pad · Available only from Browning Full Line and Medallion Dealers

(SSA) = Super-Short Action, (SA) = Short Action

	CALIBER	BARREL LENGTH	CODE NUMBER	SUGG. RETAIL	*TOTAL CAPACITY	**AVG. WEIGHT	OVERALL LENGTH	SIGHT RADIUS	***DROP AT COMB	DROP AT HEEL	LENGTH OF PULL	RATE OF TWIST	
A-BOLT MOUNTAIN Ti, MOSSY OAK NEW BREAK-UP AND BREAK-UP INFINITY													
NEW	MOINF (SA)	243 Win.	22"	035195211	\$1,939.00	5	5 lbs. 8 oz.	41¾"	—	⅝"	½"	13¾"	1 in 10"
NEW	MOINF (SA)	7mm-08 Rem.	22"	035195216	1,939.00	5	5 lbs. 7 oz.	41¾"	—	⅝"	½"	13¾"	1 in 9½"
NEW	MOINF (SA)	308 Win.	22"	035195218	1,939.00	5	5 lbs. 6 oz.	41¾"	—	⅝"	½"	13¾"	1 in 12"
	MONBU (SA)	270 WSM	23"	035038248	1,979.00	4	5 lbs. 12 oz.	42¾"	—	⅝"	½"	13¾"	1 in 10"
NEW	MOINF (SA)	270 WSM	23"	035195248	1,979.00	4	5 lbs. 12 oz.	42¾"	—	⅝"	½"	13¾"	1 in 10"
NEW	MOINF (SA)	7mm WSM	23"	035195249	1,979.00	4	5 lbs. 12 oz.	42¾"	—	⅝"	½"	13¾"	1 in 9½"
	MONBU (SA)	300 WSM	23"	035038246	1,979.00	4	5 lbs. 12 oz.	42¾"	—	⅝"	½"	13¾"	1 in 10"
NEW	MOINF (SA)	300 WSM	23"	035195246	1,979.00	4	5 lbs. 12 oz.	42¾"	—	⅝"	½"	13¾"	1 in 10"
	MONBU (SA)	325 WSM	23"	035038277	1,979.00	4	5 lbs. 12 oz.	42¾"	—	⅝"	½"	13¾"	1 in 10"
NEW	MOINF (SA)	325 WSM	23"	035195277	1,979.00	4	5 lbs. 12 oz.	42¾"	—	⅝"	½"	13¾"	1 in 10"
A-BOLT HUNTER, LEFT-HAND													
	(SSA)	223 Rem.	22"	035043208	\$879.00	5	6 lbs. 4 oz.	41¾"	—	⅝"	½"	13⅝"	1 in 12"
	(SA)	270 WSM	23"	035027248	909.00	4	6 lbs. 9 oz.	42¾"	—	⅝"	½"	13⅝"	1 in 10"
	(SA)	7mm WSM	23"	035027249	909.00	4	6 lbs. 9 oz.	42¾"	—	⅝"	½"	13⅝"	1 in 9½"
	(SA)	300 WSM	23"	035027246	909.00	4	6 lbs. 9 oz.	42¾"	—	⅝"	½"	13⅝"	1 in 10"
	(SA)	325 WSM	23"	035027277	909.00	4	6 lbs. 9 oz.	42¾"	—	⅝"	½"	13⅝"	1 in 10"
A-BOLT HUNTER, FULL LINE DEALER													
	(SA)	270 WSM	23"	035017248	\$959.00	4	6 lbs. 9 oz.	42¾"	—	⅞"	1⅞"	13⅝"	1 in 10"
	(SA)	7mm WSM	23"	035017249	959.00	4	6 lbs. 9 oz.	42¾"	—	⅞"	1⅞"	13⅝"	1 in 9½"
	(SA)	300 WSM	23"	035017246	959.00	4	6 lbs. 9 oz.	42¾"	—	⅞"	1⅞"	13⅝"	1 in 10"
	(SA)	325 WSM	23"	035017277	959.00	4	6 lbs. 9 oz.	42¾"	—	⅞"	1⅞"	13⅝"	1 in 10"

NOTE: *Total capacity includes one round in the chamber. **Weights listed are approximate. ***Measured from centerline of bore.

A-BOLT MICRO HUNTER ▶ SATIN FINISH



RECEIVER - Steel · Low-luster blued finish · Glass bedded · Drilled and tapped for scope mounts
BARREL - Low-luster blued finish · Free-floating · Hand chambered · Target crown

ACTION - Bolt-action · 60° bolt lift · Non-rotating bolt sleeve · Adjustable trigger · Detachable box magazine · Hinged floorplate · Top-tang safety
STOCK - Satin finish walnut · Sized for smaller shooters · Checkered
FEATURES - Sling swivel studs installed · Recoil pad

A-BOLT MEDALLION ▶ GLOSS FINISH

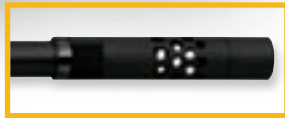

Available with BOSS® System.

RECEIVER - Steel · Engraved with blued finish · Glass bedded · Drilled and tapped for scope mounts
BARREL - Blued finish · Free-floating · Hand chambered · Target crown

ACTION - Bolt-action · 60° bolt lift · Non-rotating bolt sleeve · Adjustable trigger · Detachable box magazine · Hinged floorplate · Top-tang safety
STOCK - Select gloss finish walnut · Rosewood fore-end and grip caps · Checkered
FEATURES - Sling swivels included · Recoil pad · Available with BOSS® System

(SSA) = Super-Short Action (SA) = Short Action, (LA) = Long Action

CALIBER	BARREL LENGTH	CODE NUMBER	SUGG. RETAIL	*TOTAL CAPACITY	**AVG. WEIGHT	OVERALL LENGTH	SIGHT RADIUS	***DROP AT COMB	DROP AT HEEL	LENGTH OF PULL	RATE OF TWIST
A-BOLT MICRO HUNTER, NO SIGHTS											
(SA) 22 Hornet	22"	035020206	\$819.00	4	6 lbs. 6 oz.	41½"	—	⅝"	½"	13⅝"	1 in 16"
A-BOLT MICRO HUNTER, LEFT-HAND, NO SIGHTS (SHOWN)											
(SA) 22 Hornet	22"	035026206	\$859.00	4	6 lbs. 6 oz.	41½"	—	⅝"	½"	13⅝"	1 in 16"
(SA) 22-250 Rem.	20"	035026209	859.00	4	6 lbs. 4 oz.	39½"	—	⅝"	½"	13⅝"	1 in 14"
(SA) 243 Win.	20"	035026211	859.00	4	6 lbs. 4 oz.	39½"	—	⅝"	½"	13⅝"	1 in 10"
(SA) 7mm-08 Rem.	20"	035026216	859.00	4	6 lbs. 4 oz.	39½"	—	⅝"	½"	13⅝"	1 in 9½"
(SA) 308 Win.	20"	035026218	859.00	4	6 lbs. 4 oz.	39½"	—	⅝"	½"	13⅝"	1 in 12"
(SA) 270 WSM	22"	035026248	879.00	4	6 lbs. 6 oz.	41⅝"	—	⅝"	½"	13⅝"	1 in 10"
(SA) 7mm WSM	22"	035026249	879.00	4	6 lbs. 6 oz.	41⅝"	—	⅝"	½"	13⅝"	1 in 9½"
(SA) 300 WSM	22"	035026246	879.00	4	6 lbs. 6 oz.	41⅝"	—	⅝"	½"	13⅝"	1 in 10"
(SA) 325 WSM	22"	035026277	879.00	4	6 lbs. 6 oz.	41⅝"	—	⅝"	½"	13⅝"	1 in 10"
A-BOLT MEDALLION											
(LA) 375 H&H Mag. (open sights)	26"	035002132	\$979.00	4	7 lbs. 1 oz.	46½"	20"	⅝"	½"	13⅝"	1 in 12"
A-BOLT MEDALLION, LEFT-HAND, NO SIGHTS											
(SSA) 223 Rem.	22"	035044208	\$999.00	6	6 lbs. 4 oz.	41¼"	—	⅝"	½"	13⅝"	1 in 12"
(SA) 270 WSM	23"	035003248	1,029.00	4	6 lbs. 9 oz.	42¾"	—	⅝"	½"	13⅝"	1 in 10"
(SA) 7mm WSM	23"	035003249	1,029.00	4	6 lbs. 9 oz.	42¾"	—	⅝"	½"	13⅝"	1 in 9½"
(SA) 300 WSM	23"	035003246	1,029.00	4	6 lbs. 9 oz.	42¾"	—	⅝"	½"	13⅝"	1 in 10"
(SA) 325 WSM	23"	035003277	1,029.00	4	6 lbs. 9 oz.	42¾"	—	⅝"	½"	13⅝"	1 in 10"
(LA) 270 Win.	22"	035003224	999.00	5	6 lbs. 11 oz.	42½"	—	⅝"	½"	13⅝"	1 in 10"
(LA) 30-06 Sprg.	22"	035003226	999.00	5	6 lbs. 11 oz.	42½"	—	⅝"	½"	13⅝"	1 in 10"
(LA) 7mm Rem. Mag.	26"	035003227	1,029.00	4	7 lbs. 1 oz.	46½"	—	⅝"	½"	13⅝"	1 in 9½"
(LA) 300 Win. Mag.	26"	035003229	1,029.00	4	7 lbs. 1 oz.	46½"	—	⅝"	½"	13⅝"	1 in 10"
A-BOLT MEDALLION, WITH BOSS (SHOWN)											
(SA) 270 WSM	23"	035002348	\$1,079.00	4	6 lbs. 9 oz.	42¾"	—	⅝"	½"	13⅝"	1 in 10"
(SA) 7mm WSM	23"	035002349	1,079.00	4	6 lbs. 9 oz.	42¾"	—	⅝"	½"	13⅝"	1 in 9½"
(SA) 300 WSM	23"	035002346	1,079.00	4	6 lbs. 9 oz.	42¾"	—	⅝"	½"	13⅝"	1 in 10"
(SA) 325 WSM	23"	035002377	1,079.00	4	6 lbs. 9 oz.	42¾"	—	⅝"	½"	13⅝"	1 in 10"
(LA) 270 Win.	22"	035002324	1,059.00	5	6 lbs. 11 oz.	42½"	—	⅝"	½"	13⅝"	1 in 10"
(LA) 30-06 Sprg.	22"	035002326	1,059.00	5	6 lbs. 11 oz.	42½"	—	⅝"	½"	13⅝"	1 in 10"
(LA) 7mm Rem. Mag.	26"	035002327	1,079.00	4	7 lbs. 1 oz.	46½"	—	⅝"	½"	13⅝"	1 in 9½"
(LA) 300 Win. Mag.	26"	035002329	1,079.00	4	7 lbs. 1 oz.	46½"	—	⅝"	½"	13⅝"	1 in 10"
(LA) 338 Win. Mag.	26"	035002331	1,079.00	4	7 lbs. 1 oz.	46½"	—	⅝"	½"	13⅝"	1 in 10"
(LA) 375 H&H Mag. (open sights)	24"	035002332	1,079.00	4	7 lbs.	44½"	13"	⅝"	½"	13⅝"	1 in 12"

NOTE: *Total capacity includes one round in the chamber. **Weights listed are approximate. ***Measured from centerline of bore.

A-BOLT STAINLESS STALKER ▶ NON-GLARE COMPOSITE FINISH

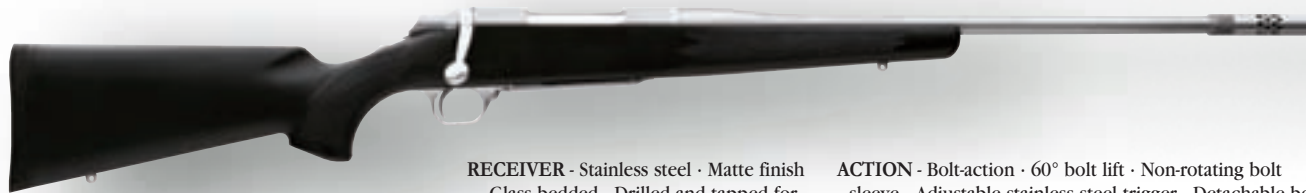

RECEIVER - Stainless steel · Matte finish
· Glass bedded · Drilled and tapped for scope mounts
BARREL - Stainless steel · Matte finish
· Free-floating · Hand chambered
· Target crown

ACTION - Bolt-action · 60° bolt lift · Non-rotating bolt sleeve · Adjustable stainless steel trigger · Detachable box magazine · Hinged floorplate · Top-tang safety
STOCK - Composite · Palm swell · Matte black · Checkered
FEATURES - Sling swivel studs installed · Recoil pad
· Available with BOSS® System

A-BOLT COMPOSITE STALKER WITH BOSS® ▶ NON-GLARE COMPOSITE FINISH



RECEIVER - Steel · Matte blued finish · Glass bedded
· Drilled and tapped for scope mounts
BARREL - Matte blued finish · Free-floating
· Hand chambered · Target crown

ACTION - Bolt-action · 60° bolt lift · Non-rotating bolt sleeve · Adjustable trigger · Detachable box magazine
· Hinged floorplate · Top-tang safety
STOCK - Composite · Palm swell · Matte black
· Checkered
FEATURES - Sling swivel studs installed
· Recoil pad · BOSS® System

(SA) = Short Action, (LA) = Long Action

	CALIBER	BARREL LENGTH	CODE NUMBER	SUGG. RETAIL	*TOTAL CAPACITY	**AVG. WEIGHT	OVERALL LENGTH	SIGHT RADIUS	***DROP AT COMB	DROP AT HEEL	LENGTH OF PULL	RATE OF TWIST
A-BOLT STAINLESS STALKER												
(LA)	375 H&H Mag. (open sights)	26"	035008132	\$1,079.00	4	7 lbs. 3 oz.	46½"	20"	5/8"	½"	13¾"	1 in 12"
A-BOLT STAINLESS STALKER, LEFT-HAND, NO SIGHTS												
(LA)	270 Win.	22"	035009224	\$1,099.00	5	6 lbs. 11 oz.	42½"	—	5/8"	½"	13¾"	1 in 10"
(LA)	30-06 Sprg.	22"	035009226	1,099.00	5	6 lbs. 11 oz.	42½"	—	5/8"	½"	13¾"	1 in 10"
(LA)	7mm Rem. Mag.	26"	035009227	1,139.00	4	7 lbs. 3 oz.	46½"	—	5/8"	½"	13¾"	1 in 9½"
(LA)	300 Win. Mag.	26"	035009229	1,139.00	4	7 lbs. 3 oz.	46½"	—	5/8"	½"	13¾"	1 in 10"
(LA)	338 Win. Mag.	26"	035009231	1,139.00	4	7 lbs. 3 oz.	46½"	—	5/8"	½"	13¾"	1 in 10"
(LA)	375 H&H Mag. (open sights)	26"	035009132	1,139.00	4	7 lbs. 3 oz.	46½"	20"	5/8"	½"	13¾"	1 in 12"
A-BOLT STAINLESS STALKER, NO SIGHTS, WITH BOSS (SHOWN)												
(SA)	270 WSM	23"	035008348	\$1,189.00	4	6 lbs. 6 oz.	42¾"	—	5/8"	½"	13¾"	1 in 10"
(SA)	7mm WSM	23"	035008349	1,189.00	4	6 lbs. 6 oz.	42¾"	—	5/8"	½"	13¾"	1 in 9½"
(SA)	300 WSM	23"	035008346	1,189.00	4	6 lbs. 6 oz.	42¾"	—	5/8"	½"	13¾"	1 in 10"
(SA)	325 WSM	23"	035008377	1,189.00	4	6 lbs. 6 oz.	42¾"	—	5/8"	½"	13¾"	1 in 10"
(LA)	270 Win.	22"	035008324	1,159.00	5	6 lbs. 11 oz.	42½"	—	5/8"	½"	13¾"	1 in 10"
(LA)	30-06 Sprg.	22"	035008326	1,159.00	5	6 lbs. 11 oz.	42½"	—	5/8"	½"	13¾"	1 in 10"
(LA)	7mm Rem. Mag.	26"	035008327	1,189.00	4	7 lbs. 3 oz.	46½"	—	5/8"	½"	13¾"	1 in 9½"
(LA)	300 Win. Mag.	26"	035008329	1,189.00	4	7 lbs. 3 oz.	46½"	—	5/8"	½"	13¾"	1 in 10"
(LA)	338 Win. Mag.	26"	035008331	1,189.00	4	7 lbs. 3 oz.	46½"	—	5/8"	½"	13¾"	1 in 10"
(LA)	375 H&H Mag. (open sights)	24"	035008332	1,189.00	4	7 lbs.	44½"	13"	5/8"	½"	13¾"	1 in 12"
A-BOLT STAINLESS STALKER, LEFT-HAND, NO SIGHTS, WITH BOSS												
(LA)	270 Win.	22"	035009324	\$1,189.00	5	6 lbs. 11 oz.	42¾"	—	5/8"	½"	13¾"	1 in 10"
(LA)	30-06 Sprg.	22"	035009326	1,189.00	5	6 lbs. 11 oz.	42¾"	—	5/8"	½"	13¾"	1 in 10"
(LA)	7mm Rem. Mag.	26"	035009327	1,229.00	4	7 lbs. 3 oz.	46¾"	—	5/8"	½"	13¾"	1 in 9½"
(LA)	300 Win. Mag.	26"	035009329	1,229.00	4	7 lbs. 3 oz.	46¾"	—	5/8"	½"	13¾"	1 in 10"
(LA)	338 Win. Mag.	26"	035009331	1,229.00	4	7 lbs. 3 oz.	46¾"	—	5/8"	½"	13¾"	1 in 10"
(LA)	375 H&H Mag. (open sights)	24"	035009332	1,229.00	4	7 lbs.	44¾"	13"	5/8"	½"	13¾"	1 in 12"
A-BOLT COMPOSITE STALKER WITH BOSS												
(SA)	270 WSM	23"	035012348	\$959.00	4	6 lbs. 6 oz.	42¾"	—	5/8"	½"	13¾"	1 in 10"
(SA)	7mm WSM	23"	035012349	959.00	4	6 lbs. 6 oz.	42¾"	—	5/8"	½"	13¾"	1 in 9½"
(SA)	300 WSM	23"	035012346	959.00	4	6 lbs. 6 oz.	42¾"	—	5/8"	½"	13¾"	1 in 10"
(SA)	325 WSM	23"	035012377	959.00	4	6 lbs. 6 oz.	42¾"	—	5/8"	½"	13¾"	1 in 10"
(LA)	25-06 Rem.	24"	035012323	939.00	5	6 lbs. 14 oz.	44½"	—	5/8"	½"	13¾"	1 in 10"
(LA)	270 Win.	22"	035012324	939.00	5	6 lbs. 11 oz.	42½"	—	5/8"	½"	13¾"	1 in 10"
(LA)	30-06 Sprg.	22"	035012326	939.00	5	6 lbs. 11 oz.	42½"	—	5/8"	½"	13¾"	1 in 10"
(LA)	7mm Rem. Mag.	26"	035012327	959.00	4	7 lbs. 3 oz.	46½"	—	5/8"	½"	13¾"	1 in 9½"
(LA)	300 Win. Mag.	26"	035012329	959.00	4	7 lbs. 3 oz.	46½"	—	5/8"	½"	13¾"	1 in 10"
(LA)	338 Win. Mag.	26"	035012331	959.00	4	7 lbs. 3 oz.	46½"	—	5/8"	½"	13¾"	1 in 10"

NOTE: *Total capacity includes one round in the chamber. **Weights listed are approximate. ***Measured from centerline of bore.



A-BOLT TARGET ▶ SATIN FINISH



RECEIVER - Steel · Matte blued finish · Glass bedded
 · Drilled and tapped for scope mounts
BARREL - Heavy bull contour · Matte blued finish
 · Free-floating · Hand chambered · Target crown
ACTION - Bolt-action · 60° bolt lift · Non-rotating bolt sleeve
 · Single-set trigger · Hinged floorplate · Top-tang safety

STOCK - Satin finish gray laminate wood · Target style with wide, flat fore-end · Adjustable comb
 · Right-hand palm swell · Checkered
FEATURES - Front sling swivel installed · Recoil pad · Scope and mounts not included

A-BOLT TARGET STAINLESS ▶ SATIN FINISH



RECEIVER - Stainless steel · Low luster finish
 · Glass bedded · Drilled and tapped for scope mounts
BARREL - Heavy bull contour · Stainless steel · Low luster finish
 · Free-floating · Hand chambered · Target crown
ACTION - Bolt-action · 60° bolt lift · Non-rotating bolt sleeve
 · Single-set trigger · Hinged floorplate · Top-tang safety

STOCK - Satin finish gray laminate wood · Target style with wide, flat fore-end · Adjustable comb
 · Right-hand palm swell · Checkered
FEATURES - Front sling swivel installed · Recoil pad · Scope and mounts not included

A-BOLT TARGET RIFLES. MAXIMUM ACCURACY RIGHT FROM THE BOX.

Browning A-Bolt Target models further improve on the already impressive accuracy of the rugged A-Bolt rifle. Target models feature a precise target-style, single-set trigger that is factory-adjusted to approximately 9-14 ounces (250-400 grams) of pull weight in the set mode, and also operates as a conventional trigger with an adjustment range of 4-6 lbs. The action and barrel are carefully bedded in a beautiful laminated stock with a wide fore-end to provide exceptional stability on sandbags or from a bench rest. The adjustable comb allows perfect eye-to-scope alignment, even with large objective target optics. A close-radius pistol grip ensures an easy reach to the trigger and lets you squeeze the most out of an A-Bolt Target rifle's accuracy.

(SA) = Short Action, (LA) = Long Action

	CALIBER	BARREL LENGTH	CODE NUMBER	SUGG. RETAIL	*TOTAL CAPACITY	**AVG. WEIGHT	OVERALL LENGTH	SIGHT RADIUS	***DROP AT COMB	DROP AT HEEL	LENGTH OF PULL	RATE OF TWIST
A-BOLT TARGET												
	(SA) 223 Rem.	28"	035189208	\$1,359.00	6	13 lbs. 4 oz.	47¾"	—	⅝" Adj.	⅝" Adj.	13¾"	1 in 8"
	(SA) 308 Win.	28"	035189218	1,359.00	5	13 lbs.	47¾"	—	⅝" Adj.	⅝" Adj.	13¾"	1 in 10"
	(SA) 300 WSM	28"	035189248	1,389.00	4	13 lbs.	47¾"	—	⅝" Adj.	⅝" Adj.	13¾"	1 in 10"
A-BOLT TARGET STAINLESS												
	(SA) 223 Rem.	28"	035190208	\$1,589.00	6	13 lbs. 4 oz.	47¾"	—	⅝" Adj.	⅝" Adj.	13¾"	1 in 8"
	(SA) 308 Win.	28"	035190218	1,589.00	5	13 lbs.	47¾"	—	⅝" Adj.	⅝" Adj.	13¾"	1 in 10"
	(SA) 300 WSM	28"	035190248	1,629.00	4	13 lbs.	47¾"	—	⅝" Adj.	⅝" Adj.	13¾"	1 in 10"

NOTE: *Total capacity includes one round in the chamber. **Weights listed are approximate. ***Measured from centerline of bore.

A-BOLT ECLIPSE™ HUNTER WITH BOSS® ▶ SATIN FINISH

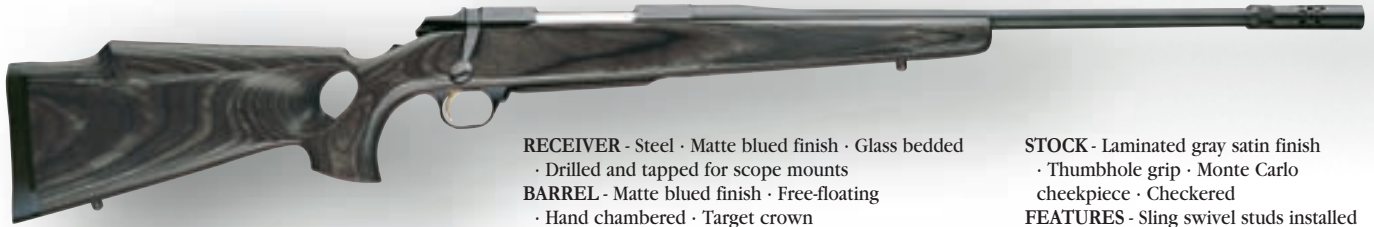

RECEIVER - Steel · Matte blued finish · Glass bedded · Drilled and tapped for scope mounts
BARREL - Matte blued finish · Free-floating · Hand chambered · Target crown
ACTION - Bolt-action · 60° bolt lift · Non-rotating bolt sleeve · Adjustable trigger · Detachable box magazine · Hinged floorplate · Top-tang safety

STOCK - Laminated gray satin finish · Thumbhole grip · Monte Carlo cheekpiece · Checkered
FEATURES - Sling swivel studs installed · Recoil pad · BOSS® System

A-BOLT M-1000 ECLIPSE™ ▶ SATIN FINISH

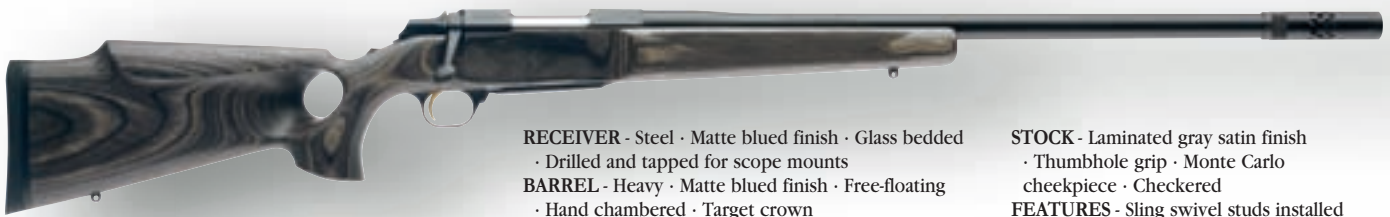

RECEIVER - Steel · Matte blued finish · Glass bedded · Drilled and tapped for scope mounts
BARREL - Heavy · Matte blued finish · Free-floating · Hand chambered · Target crown
ACTION - Bolt-action · 60° bolt lift · Non-rotating bolt sleeve · Adjustable trigger · Detachable box magazine · Hinged floorplate · Top-tang safety

STOCK - Laminated gray satin finish · Thumbhole grip · Monte Carlo cheekpiece · Checkered
FEATURES - Sling swivel studs installed · Recoil pad · Available with BOSS® System

A-BOLT STAINLESS M-1000 ECLIPSE™ ▶ SATIN FINISH

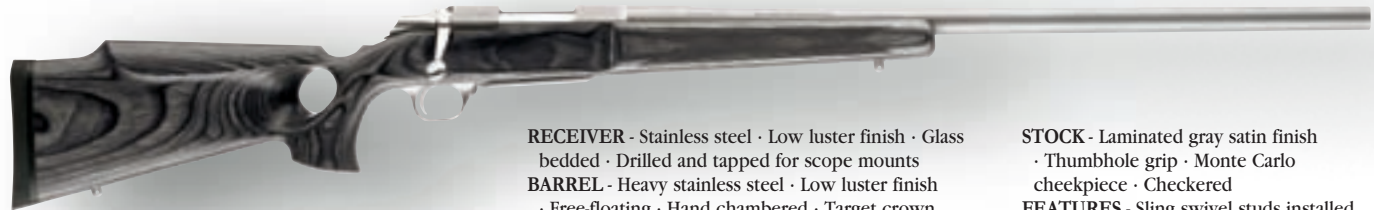

RECEIVER - Stainless steel · Low luster finish · Glass bedded · Drilled and tapped for scope mounts
BARREL - Heavy stainless steel · Low luster finish · Free-floating · Hand chambered · Target crown
ACTION - Bolt-action · 60° bolt lift · Non-rotating bolt sleeve · Adjustable stainless steel trigger · Detachable box magazine · Hinged floorplate · Top-tang safety

STOCK - Laminated gray satin finish · Thumbhole grip · Monte Carlo cheekpiece · Checkered
FEATURES - Sling swivel studs installed · Recoil pad · Available with BOSS® System

(SA) = Short Action, (LA) = Long Action

	CALIBER	BARREL LENGTH	CODE NUMBER	SUGG. RETAIL	*TOTAL CAPACITY	**AVG. WEIGHT	OVERALL LENGTH	SIGHT RADIUS	***DROP AT COMB	DROP AT HEEL	LENGTH OF PULL	RATE OF TWIST
A-BOLT ECLIPSE HUNTER WITH BOSS												
	(LA) 270 Win.	22"	035005324	\$1,349.00	5	7 lbs. 8 oz.	42¾"	—	¾"	½"	13¾"	1 in 10"
	(LA) 30-06 Sprg.	22"	035005326	1,349.00	5	7 lbs. 8 oz.	42¾"	—	¾"	½"	13¾"	1 in 10"
	(LA) 7mm Rem. Mag.	26"	035005327	1,379.00	4	7 lbs. 12 oz.	46¾"	—	¾"	½"	13¾"	1 in 9½"
A-BOLT M-1000 ECLIPSE												
	(SA) 22-250 Rem.	26"	035007209	\$1,259.00	5	9 lbs. 14 oz.	45¾"	—	⅝"	½"	13¾"	1 in 14"
	(SA) 308 Win.	26"	035007218	1,259.00	5	9 lbs. 14 oz.	45¾"	—	⅝"	½"	13¾"	1 in 12"
	(SA) 270 WSM	26"	035007248	1,279.00	4	9 lbs. 14 oz.	45¾"	—	⅝"	½"	13¾"	1 in 10"
	(SA) 7mm WSM	26"	035007249	1,279.00	4	9 lbs. 14 oz.	45¾"	—	⅝"	½"	13¾"	1 in 9½"
	(SA) 300 WSM	26"	035007246	1,279.00	4	9 lbs. 14 oz.	45¾"	—	⅝"	½"	13¾"	1 in 10"
A-BOLT M-1000 ECLIPSE WITH BOSS (SHOWN)												
	(SA) 22-250 Rem.	26"	035007309	\$1,349.00	5	10 lbs.	45¾"	—	⅝"	½"	13¾"	1 in 14"
	(SA) 308 Win.	26"	035007318	1,349.00	5	10 lbs.	45¾"	—	⅝"	½"	13¾"	1 in 12"
	(SA) 270 WSM	26"	035007348	1,379.00	4	10 lbs.	45¾"	—	⅝"	½"	13¾"	1 in 10"
	(SA) 7mm WSM	26"	035007349	1,379.00	4	10 lbs.	45¾"	—	⅝"	½"	13¾"	1 in 9½"
	(SA) 300 WSM	26"	035007346	1,379.00	4	10 lbs.	45¾"	—	⅝"	½"	13¾"	1 in 10"
	(LA) 300 Win. Mag.	26"	035007329	1,379.00	4	10 lbs.	46½"	—	⅝"	½"	13¾"	1 in 10"
A-BOLT STAINLESS M-1000 ECLIPSE (SHOWN)												
	(SA) 22-250 Rem.	26"	035032209	\$1,499.00	5	9 lbs. 14 oz.	45¾"	—	⅝"	½"	13¾"	1 in 14"
	(SA) 308 Win.	26"	035032218	1,499.00	5	9 lbs. 14 oz.	45¾"	—	⅝"	½"	13¾"	1 in 12"
	(SA) 270 WSM	26"	035032248	1,539.00	4	9 lbs. 14 oz.	45¾"	—	⅝"	½"	13¾"	1 in 10"
	(SA) 7mm WSM	26"	035032249	1,539.00	4	9 lbs. 14 oz.	45¾"	—	⅝"	½"	13¾"	1 in 9½"
	(SA) 300 WSM	26"	035032246	1,539.00	4	9 lbs. 14 oz.	45¾"	—	⅝"	½"	13¾"	1 in 10"
A-BOLT STAINLESS M-1000 ECLIPSE WITH BOSS												
	(SA) 22-250 Rem.	26"	035032309	\$1,589.00	5	10 lbs.	45¾"	—	⅝"	½"	13¾"	1 in 14"
	(SA) 308 Win.	26"	035032318	1,589.00	5	10 lbs.	45¾"	—	⅝"	½"	13¾"	1 in 12"
	(SA) 270 WSM	26"	035032348	1,629.00	4	10 lbs.	45¾"	—	⅝"	½"	13¾"	1 in 10"
	(SA) 7mm WSM	26"	035032349	1,629.00	4	10 lbs.	45¾"	—	⅝"	½"	13¾"	1 in 9½"
	(SA) 300 WSM	26"	035032346	1,629.00	4	10 lbs.	45¾"	—	⅝"	½"	13¾"	1 in 10"

NOTE: *Total capacity includes one round in the chamber. **Weights listed are approximate. ***Measured from centerline of bore.



BOSS®-CR ACCESSORY

The BOSS-CR accessory offers all the accuracy and tunable advantages of the original BOSS device without the muzzle brake feature. By simply replacing the original BOSS forward weight and recoil reduction components with the one-piece, no-hole BOSS-CR accessory, only the reduced recoil of the original BOSS is sacrificed. The BOSS-CR accessory is designed to fit only BAR Mark II and A-Bolt centerfire rifles previously factory-fitted with the BOSS.

GLOSS	MATTE	STAINLESS
BAR SAFARI AND THE FOLLOWING A-BOLT MODELS: MEDALLION GOLD MEDALLION	A-BOLT MODELS: COMPOSITE STALKER HUNTER EURO-BOLT VARMINT ECLIPSE HUNTER M-1000 ECLIPSE	A-BOLT MODELS: STAINLESS STALKER WHITE GOLD MEDALLION M-1000 ECLIPSE

CALIBER	CODE #	CODE #	CODE #
223 Rem.	1140011	1140012	1140013
223 Varmint	1140061	1140062	—
223 WSSM	1140011	1140012	1140013
243 WSSM	1140011	1140012	1140013
25 WSSM	1140011	1140012	1140013
22-250 Rem.	1140011	1140012	1140013
22-250 Varmint	1140061	1140062	—
22-250 Varmint (M1000)	—	1140062	1140063
243 Win.	1140011	1140012	1140013
7mm-08 Rem.	1140011	1140012	1140013
308 Win.	1140021	1140022	1140023
308 Varmint	1140061	1140062	—
308 Varmint (M1000)	—	1140062	1140063
25-06 Rem.	1140011	1140012	1140013
260 Rem.	1140011	1140012	1140013
270 WSM	1140021	1140022	1140023
270 Win.	1140011	1140012	1140013
280 Rem.	1140011	1140012	1140013
30-06 Sprg.	1140031	1140032	1140033
7mm WSM	1140021	1140022	1140023
7mm Rem. Mag.	1140021	1140022	1140023
300 WSM	1140041	1140042	1140043
300 WSM (M1000)	—	1140092	1140093
300 Win. Mag.	1140041	1140042	1140043
300 Win. Mag. (M1000)	—	1140092	—
325 WSM	1140051	1140052	1140053
338 Win. Mag.	1140051	1140052	1140053
375 H&H Mag.	1140071	—	1140073

It is important that the correct BOSS-CR be selected for a specific caliber and model of rifle.

MODEL	SUGG. RETAIL
BOSS-CR, matte blue	\$29.00
BOSS-CR, gloss blue	29.00
BOSS-CR, stainless	39.00



A-BOLT® EXTRA MAGAZINES

CALIBER	CODE NUMBER	SUGG. RETAIL
EXTRA MAGAZINES (ALL MODELS EXCEPT MICRO HUNTER)		
222 Rem.	112022007	\$69.99
204 Ruger	112022066	69.99
22-250 Rem.	112022009	69.99
223 Rem.	112022008	69.99
223 WSSM	112022044	69.99
223 Rem. SSA	112022060	69.99
243 Win.	112022011	69.99
243 WSSM	112022045	69.99
270 WSM	112022035	69.99
7mm-08 Rem.	112022016	69.99
7mm WSM	112022036	69.99
308 Win.	112022018	69.99
300 WSM	112022034	69.99
25 WSSM	112022049	69.99
25-06 Rem.	112022023	69.99
270 Win.	112022024	69.99
280 Rem.	112022025	69.99
30-06 Sprg.	112022026	69.99
7mm Rem. Mag.	112022027	69.99
300 Win. Mag.	112022029	69.99
300 Ultra Mag.	112022030	69.99
325 WSM	112022065	69.99
338 Win. Mag.	112022031	69.99
375 H&H Mag.	112022032	69.99
338 Ultra Mag.	112022038	69.99
EXTRA MAGAZINES (MICRO HUNTER)		
22 Hornet	112023006	\$69.99
22-250 Rem.	112023009	69.99
243 Win.	112023011	69.99
270 WSM	112023041	69.99
7mm WSM	112023042	69.99
7mm-08 Rem.	112023016	69.99
308 Win.	112023018	69.99
300 WSM	112023040	69.99
325 WSM	112023004	69.99

NOTE: Magazines that are not listed above may be available only through the Browning Parts Department at (800) 322-4626.

BLR

BLR® — THE LEVER ACTION FOR TODAY'S MARKSMEN. Most of the famous lever-action rifles in history have the name Browning attached to them. All were ground-breaking designs and lauded for their dependability. The Browning BLR is the modern version of those classics, with a rugged rack and pinion-driven bolt that locks up tight to the barrel making the BLR capable of accuracy other lever actions could only wish for.



ACTION

Advanced, lightning fast, glass-smooth rack and pinion lever-action. Strong rotating head, multiple-lug breech bolt with a recessed bolt face and side ejection.

TRIGGER

Wide groove design trigger with short, smooth pull. The trigger travels with the lever to avoid pinching your fingers when cycling.



MAGAZINE

The flush-mounted detachable box magazine has a capacity of three magnum or four standard rounds in the magazine, plus one in the chamber.



HAMMER The fold-down hammer has two positions at half-cock so the status of the rifle is readily seen. The folding hammer provides an added measure of safety when the hammer is at half-cock. The hammer has four basic positions: full-cock, half-cock, folded hammer position and dropped, or fired position.



RECEIVER Lightweight, sturdy machined aircraft-grade aluminum. Drilled and tapped to accept scope mounts.

SIGHTS Low profile, square notch, screw adjustable rear sight aligns easily with a highly visible gold bead on raised ramp front sight.



TAKEDOWN FEATURES BLR Takedown models are just as accurate and reliable as their unified counterparts but much easier to transport and store. The rifle is easily and quickly assembled without tools by simply sliding the barrel half into the receiver half and locking them together with the flip of a lever. The lever mechanically engages a stout locking lug into a recess in the bottom of the receiver. The system is rugged, precise and blends seamlessly into the styling of the rifle.

SCOPE MOUNTS A scout-style scope mount is available as an accessory for the BLR Takedown models. This one-piece alloy base mounts forward of the receiver and stays attached to the barrel half of the rifle when disassembled to retain the scope's zero. A long eye-relief scope is required (not included). The receiver is also drilled and tapped for conventional scope bases and rings (not included). Three scout-style scope mounts are available for BLR Scout models, depending on the caliber (see chart on page 55).

All Browning firearms are shipped with a free locking device to assist in the safe storage of firearms.

BLR LIGHTWEIGHT STAINLESS WITH PISTOL GRIP ▶ GLOSS FINISH

NEW



RECEIVER - Aircraft-grade alloy · Satin nickel finish · Drilled and tapped for scope mounts

BARREL - Matte stainless steel finish · Crowned muzzle · Adjustable sights

ACTION - Lever action · Rotating bolt · Detachable box magazine

STOCK - Gloss finish walnut · Checkered pistol grip with Schnabel forearm

FEATURES - Sling swivel studs installed · Recoil pad

BLR LIGHTWEIGHT '81 STAINLESS TAKEDOWN ▶ SATIN FINISH

NEW



RECEIVER - Aircraft-grade alloy · Satin nickel finish · Drilled and tapped for scope mounts

BARREL - Matte stainless steel finish · Crowned muzzle · Adjustable sights · Drilled and tapped for scope mount

ACTION - Lever action · Rotating bolt · Detachable box magazine

STOCK - Satin finish gray laminate wood · Checkered straight grip

FEATURES - Recoil pad · Separates for storage or transportation · Optional scout-style scope mount · TRUGLO®/Marble's® fiber-optic front sight

(SA) = Short Action, (LA) = Long Action

	CALIBER	BARREL LENGTH	CODE NUMBER	SUGG. RETAIL	*TOTAL CAPACITY	**AVG. WEIGHT	OVERALL LENGTH	SIGHT RADIUS	***DROP AT COMB	DROP AT HEEL	LENGTH OF PULL	RATE OF TWIST
BLR LIGHTWEIGHT STAINLESS WITH PISTOL GRIP, SHORT ACTION												
NEW (SA)	223 Rem.	20"	034018108	\$999.00	5	6 lbs. 8 oz.	40"	17¾"	¾"	1½"	13¾"	1 in 12"
NEW (SA)	22-250 Rem.	20"	034018109	999.00	5	6 lbs. 8 oz.	40"	17¾"	¾"	1½"	13¾"	1 in 14"
NEW (SA)	243 Win.	20"	034018111	999.00	5	6 lbs. 8 oz.	40"	17¾"	¾"	1½"	13¾"	1 in 10"
NEW (SA)	7mm-08 Rem.	20"	034018116	999.00	5	6 lbs. 8 oz.	40"	17¾"	¾"	1½"	13¾"	1 in 9½"
NEW (SA)	308 Win.	20"	034018118	999.00	5	6 lbs. 8 oz.	40"	17¾"	¾"	1½"	13¾"	1 in 12"
NEW (SA)	358 Win.	20"	034018120	999.00	5	6 lbs. 8 oz.	40"	17¾"	¾"	1½"	13¾"	1 in 12"
NEW (SA)	450 Marlin	20"	034018150	999.00	4	7 lbs.	40"	17¾"	¾"	1½"	13¾"	1 in 20"
NEW (SA)	270 WSM	22"	034018148	1,079.00	4	6 lbs. 12 oz.	42"	19¾"	¾"	1½"	13¾"	1 in 10"
NEW (SA)	7mm WSM	22"	034018149	1,079.00	4	6 lbs. 12 oz.	42"	19¾"	¾"	1½"	13¾"	1 in 9½"
NEW (SA)	300 WSM	22"	034018146	1,079.00	4	6 lbs. 12 oz.	42"	19¾"	¾"	1½"	13¾"	1 in 10"
NEW (SA)	325 WSM	22"	034018177	1,079.00	4	6 lbs. 12 oz.	42"	19¾"	¾"	1½"	13¾"	1 in 10"
BLR LIGHTWEIGHT STAINLESS WITH PISTOL GRIP, LONG ACTION												
NEW (LA)	270 Win.	22"	034018124	\$1,059.00	5	7 lbs. 4 oz.	43"	19¾"	1"	1½"	14¼"	1 in 10"
NEW (LA)	30-06 Sprg.	22"	034018126	1,059.00	5	7 lbs. 4 oz.	43"	19¾"	1"	1½"	14¼"	1 in 10"
NEW (LA)	7mm Rem. Mag.	24"	034018127	1,059.00	4	7 lbs. 12 oz.	45"	20"	1"	1½"	14¼"	1 in 9½"
NEW (LA)	300 Win. Mag.	24"	034018129	1,059.00	4	7 lbs. 12 oz.	45"	20"	1"	1½"	14¼"	1 in 10"
BLR LIGHTWEIGHT '81 STAINLESS TAKEDOWN, SHORT ACTION												
NEW (SA)	223 Rem.	20"	034015108	\$1,149.00	5	6 lbs. 8 oz.	40"	17¾"	¾"	1½"	13¾"	1 in 12"
NEW (SA)	22-250 Rem.	20"	034015109	1,149.00	5	6 lbs. 8 oz.	40"	17¾"	¾"	1½"	13¾"	1 in 14"
NEW (SA)	243 Win.	20"	034015111	1,149.00	5	6 lbs. 8 oz.	40"	17¾"	¾"	1½"	13¾"	1 in 10"
NEW (SA)	7mm-08 Rem.	20"	034015116	1,149.00	5	6 lbs. 8 oz.	40"	17¾"	¾"	1½"	13¾"	1 in 9½"
NEW (SA)	308 Win.	20"	034015118	1,149.00	5	6 lbs. 8 oz.	40"	17¾"	¾"	1½"	13¾"	1 in 12"
NEW (SA)	358 Win.	20"	034015120	1,149.00	5	6 lbs. 8 oz.	40"	17¾"	¾"	1½"	13¾"	1 in 12"
NEW (SA)	450 Marlin	20"	034015150	1,149.00	4	7 lbs.	40"	17¾"	¾"	1½"	13¾"	1 in 20"
NEW (SA)	270 WSM	22"	034015148	1,229.00	4	6 lbs. 12 oz.	42"	19¾"	¾"	1½"	13¾"	1 in 10"
NEW (SA)	7mm WSM	22"	034015149	1,229.00	4	6 lbs. 12 oz.	42"	19¾"	¾"	1½"	13¾"	1 in 9½"
NEW (SA)	300 WSM	22"	034015146	1,229.00	4	6 lbs. 12 oz.	42"	19¾"	¾"	1½"	13¾"	1 in 10"
NEW (SA)	325 WSM	22"	034015177	1,229.00	4	6 lbs. 12 oz.	42"	19¾"	¾"	1½"	13¾"	1 in 10"
BLR LIGHTWEIGHT '81 STAINLESS TAKEDOWN, LONG ACTION												
NEW (LA)	270 Win.	22"	034015124	\$1,199.00	5	7 lbs. 4 oz.	43"	19¾"	1"	1½"	14¼"	1 in 10"
NEW (LA)	30-06 Sprg.	22"	034015126	1,199.00	5	7 lbs. 4 oz.	43"	19¾"	1"	1½"	14¼"	1 in 10"
NEW (LA)	7mm Rem. Mag.	24"	034015127	1,199.00	4	7 lbs. 12 oz.	45"	20"	1"	1½"	14¼"	1 in 9½"
NEW (LA)	300 Win. Mag.	24"	034015129	1,199.00	4	7 lbs. 12 oz.	45"	20"	1"	1½"	14¼"	1 in 10"

NOTE: *Total capacity includes one round in the chamber. **Weights listed are approximate. ***Measured from centerline of bore.

BLR LIGHTWEIGHT TAKEDOWN WITH PISTOL GRIP ▶ GLOSS FINISH



RECEIVER - Aircraft-grade alloy
· Blued finish · Drilled and tapped for scope mounts

BARREL - Blued finish · Crowned muzzle · Adjustable sights · Drilled and tapped for scout mount

ACTION - Lever action · Rotating bolt
· Detachable box magazine
STOCK - Gloss finish walnut · Checkered pistol grip with Schnabel forearm
FEATURES - Sling swivel studs installed
· Recoil pad · Separates for storage or transportation · Optional scout-style scope mount

BLR LIGHTWEIGHT TAKEDOWN SCOUT-STYLE SCOPE MOUNT

DESCRIPTION	CODE #	SUGG. RETAIL
Short Action Mount	12327	\$69.99
WSM/Long Action/Magnum Mount	12326	69.99
450 Marlin Mount	12325	69.99

FEATURES
· Aircraft-grade alloy
· Blued finish
· One-piece design
· Easy installation



BLR LIGHTWEIGHT WITH PISTOL GRIP ▶ GLOSS FINISH



RECEIVER - Aircraft-grade alloy
· Blued finish · Drilled and tapped for scope mounts

BARREL - Blued finish · Crowned muzzle · Adjustable sights

ACTION - Lever action · Rotating bolt
· Detachable box magazine
STOCK - Gloss finish walnut · Checkered pistol grip with Schnabel forearm
FEATURES - Sling swivel studs installed
· Recoil pad

(SA) = Short Action, (LA) = Long Action

	CALIBER	BARREL LENGTH	CODE NUMBER	SUGG. RETAIL	*TOTAL CAPACITY	**AVG. WEIGHT	OVERALL LENGTH	SIGHT RADIUS	***DROP AT COMB	DROP AT HEEL	LENGTH OF PULL	RATE OF TWIST
BLR LIGHTWEIGHT TAKEDOWN WITH PISTOL GRIP, SHORT ACTION												
NEW	(SA) 223 Rem.	20"	034012108	\$999.00	5	6 lbs. 8 oz.	40"	17 ³ / ₄ "	⁷ / ₈ "	1 ⁵ / ₁₆ "	13 ³ / ₄ "	1 in 12"
	(SA) 22-250 Rem.	20"	034012109	999.00	5	6 lbs. 8 oz.	40"	17 ³ / ₄ "	⁷ / ₈ "	1 ⁵ / ₁₆ "	13 ³ / ₄ "	1 in 14"
	(SA) 243 Win.	20"	034012111	999.00	5	6 lbs. 8 oz.	40"	17 ³ / ₄ "	⁷ / ₈ "	1 ⁵ / ₁₆ "	13 ³ / ₄ "	1 in 10"
	(SA) 7mm-08 Rem.	20"	034012116	999.00	5	6 lbs. 8 oz.	40"	17 ³ / ₄ "	⁷ / ₈ "	1 ⁵ / ₁₆ "	13 ³ / ₄ "	1 in 9 ¹ / ₂ "
	(SA) 308 Win.	20"	034012118	999.00	5	6 lbs. 8 oz.	40"	17 ³ / ₄ "	⁷ / ₈ "	1 ⁵ / ₁₆ "	13 ³ / ₄ "	1 in 12"
	(SA) 358 Win.	20"	034012120	999.00	5	6 lbs. 8 oz.	40"	17 ³ / ₄ "	⁷ / ₈ "	1 ⁵ / ₁₆ "	13 ³ / ₄ "	1 in 12"
	(SA) 450 Marlin	20"	034012150	999.00	4	7 lbs.	40"	17 ³ / ₄ "	⁷ / ₈ "	1 ⁵ / ₁₆ "	13 ³ / ₄ "	1 in 20"
	(SA) 270 WSM	22"	034012148	1,079.00	4	6 lbs. 12 oz.	42"	19 ³ / ₄ "	⁷ / ₈ "	1 ⁵ / ₁₆ "	13 ³ / ₄ "	1 in 10"
	(SA) 7mm WSM	22"	034012149	1,079.00	4	6 lbs. 12 oz.	42"	19 ³ / ₄ "	⁷ / ₈ "	1 ⁵ / ₁₆ "	13 ³ / ₄ "	1 in 9 ¹ / ₂ "
	(SA) 300 WSM	22"	034012146	1,079.00	4	6 lbs. 12 oz.	42"	19 ³ / ₄ "	⁷ / ₈ "	1 ⁵ / ₁₆ "	13 ³ / ₄ "	1 in 10"
	(SA) 325 WSM	22"	034012177	1,079.00	4	6 lbs. 12 oz.	42"	19 ³ / ₄ "	⁷ / ₈ "	1 ⁵ / ₁₆ "	13 ³ / ₄ "	1 in 10"
BLR LIGHTWEIGHT TAKEDOWN WITH PISTOL GRIP, LONG ACTION												
	(LA) 270 Win.	22"	034012124	\$1,059.00	5	7 lbs. 4 oz.	43"	19 ³ / ₄ "	1"	1 ⁵ / ₈ "	14 ¹ / ₄ "	1 in 10"
	(LA) 30-06 Sprg.	22"	034012126	1,059.00	5	7 lbs. 4 oz.	43"	19 ³ / ₄ "	1"	1 ⁵ / ₈ "	14 ¹ / ₄ "	1 in 10"
	(LA) 7mm Rem. Mag.	24"	034012127	1,059.00	4	7 lbs. 12 oz.	45"	20"	1"	1 ⁵ / ₈ "	14 ¹ / ₄ "	1 in 9 ¹ / ₂ "
	(LA) 300 Win. Mag.	24"	034012129	1,059.00	4	7 lbs. 12 oz.	45"	20"	1"	1 ⁵ / ₈ "	14 ¹ / ₄ "	1 in 10"
BLR LIGHTWEIGHT WITH PISTOL GRIP, SHORT ACTION												
NEW	(SA) 223 Rem.	20"	034009108	\$919.00	5	6 lbs. 8 oz.	40"	17 ³ / ₄ "	⁷ / ₈ "	1 ⁵ / ₁₆ "	13 ³ / ₄ "	1 in 12"
	(SA) 22-250 Rem.	20"	034009109	919.00	5	6 lbs. 8 oz.	40"	17 ³ / ₄ "	⁷ / ₈ "	1 ⁵ / ₁₆ "	13 ³ / ₄ "	1 in 14"
	(SA) 243 Win.	20"	034009111	919.00	5	6 lbs. 8 oz.	40"	17 ³ / ₄ "	⁷ / ₈ "	1 ⁵ / ₁₆ "	13 ³ / ₄ "	1 in 10"
	(SA) 7mm-08 Rem.	20"	034009116	919.00	5	6 lbs. 8 oz.	40"	17 ³ / ₄ "	⁷ / ₈ "	1 ⁵ / ₁₆ "	13 ³ / ₄ "	1 in 9 ¹ / ₂ "
	(SA) 308 Win.	20"	034009118	919.00	5	6 lbs. 8 oz.	40"	17 ³ / ₄ "	⁷ / ₈ "	1 ⁵ / ₁₆ "	13 ³ / ₄ "	1 in 12"
	(SA) 358 Win.	20"	034009120	919.00	5	6 lbs. 8 oz.	40"	17 ³ / ₄ "	⁷ / ₈ "	1 ⁵ / ₁₆ "	13 ³ / ₄ "	1 in 12"
	(SA) 450 Marlin	20"	034009150	919.00	4	7 lbs.	40"	17 ³ / ₄ "	⁷ / ₈ "	1 ⁵ / ₁₆ "	13 ³ / ₄ "	1 in 20"
	(SA) 270 WSM	22"	034009148	999.00	4	6 lbs. 12 oz.	42"	19 ³ / ₄ "	⁷ / ₈ "	1 ⁵ / ₁₆ "	13 ³ / ₄ "	1 in 10"
	(SA) 7mm WSM	22"	034009149	999.00	4	6 lbs. 12 oz.	42"	19 ³ / ₄ "	⁷ / ₈ "	1 ⁵ / ₁₆ "	13 ³ / ₄ "	1 in 9 ¹ / ₂ "
	(SA) 300 WSM	22"	034009146	999.00	4	6 lbs. 12 oz.	42"	19 ³ / ₄ "	⁷ / ₈ "	1 ⁵ / ₁₆ "	13 ³ / ₄ "	1 in 10"
	(SA) 325 WSM	22"	034009177	999.00	4	6 lbs. 12 oz.	42"	19 ³ / ₄ "	⁷ / ₈ "	1 ⁵ / ₁₆ "	13 ³ / ₄ "	1 in 10"
BLR LIGHTWEIGHT WITH PISTOL GRIP, LONG ACTION												
	(LA) 270 Win.	22"	034009124	\$979.00	5	7 lbs. 4 oz.	43"	19 ³ / ₄ "	1"	1 ⁵ / ₈ "	14 ¹ / ₄ "	1 in 10"
	(LA) 30-06 Sprg.	22"	034009126	979.00	5	7 lbs. 4 oz.	43"	19 ³ / ₄ "	1"	1 ⁵ / ₈ "	14 ¹ / ₄ "	1 in 10"
	(LA) 7mm Rem. Mag.	24"	034009127	979.00	4	7 lbs. 12 oz.	45"	20"	1"	1 ⁵ / ₈ "	14 ¹ / ₄ "	1 in 9 ¹ / ₂ "
	(LA) 300 Win. Mag.	24"	034009129	979.00	4	7 lbs. 12 oz.	45"	20"	1"	1 ⁵ / ₈ "	14 ¹ / ₄ "	1 in 10"

NOTE: *Total capacity includes one round in the chamber. **Weights listed are approximate. ***Measured from centerline of bore.

BLR LIGHTWEIGHT '81 TAKEDOWN ▶ GLOSS FINISH



RECEIVER - Aircraft-grade alloy
 · Blued finish · Drilled and tapped for scope mounts
BARREL - Blued finish · Crowned muzzle · Adjustable sights · Drilled and tapped for scout mount
ACTION - Lever action · Rotating bolt · Detachable box magazine

STOCK - Gloss finish walnut
 · Checkered · Straight grip
FEATURES - Recoil pad · Separates for storage or transportation
 · Optional scout-style scope mount
 · Scope and mounts not included

BLR LIGHTWEIGHT '81 ▶ GLOSS FINISH



RECEIVER - Aircraft-grade alloy
 · Blued finish · Drilled and tapped for scope mounts
BARREL - Blued finish · Crowned muzzle · Adjustable sights

ACTION - Lever action · Rotating bolt · Detachable box magazine
STOCK - Gloss finish walnut
 · Checkered · Straight grip
FEATURES - Recoil pad

(SA) = Short Action, (LA) = Long Action

	CALIBER	BARREL LENGTH	CODE NUMBER	SUGG. RETAIL	*TOTAL CAPACITY	**AVG. WEIGHT	OVERALL LENGTH	SIGHT RADIUS	***DROP AT COMB	DROP AT HEEL	LENGTH OF PULL	RATE OF TWIST
BLR LIGHTWEIGHT '81 TAKEDOWN, SHORT ACTION												
NEW	(SA) 223 Rem.	20"	034011108	\$959.00	5	6 lbs. 8 oz.	40"	17¾"	7/8"	1½"	13¾"	1 in 12"
	(SA) 22-250 Rem.	20"	034011109	959.00	5	6 lbs. 8 oz.	40"	17¾"	7/8"	1½"	13¾"	1 in 14"
	(SA) 243 Win.	20"	034011111	959.00	5	6 lbs. 8 oz.	40"	17¾"	7/8"	1½"	13¾"	1 in 10"
	(SA) 7mm-08 Rem.	20"	034011116	959.00	5	6 lbs. 8 oz.	40"	17¾"	7/8"	1½"	13¾"	1 in 9½"
	(SA) 308 Win.	20"	034011118	959.00	5	6 lbs. 8 oz.	40"	17¾"	7/8"	1½"	13¾"	1 in 12"
	(SA) 358 Win.	20"	034011120	959.00	5	6 lbs. 8 oz.	40"	17¾"	7/8"	1½"	13¾"	1 in 12"
	(SA) 450 Marlin	20"	034011150	959.00	4	7 lbs.	40"	17¾"	7/8"	1½"	13¾"	1 in 20"
	(SA) 270 WSM	22"	034011148	1,039.00	4	6 lbs. 12 oz.	42"	19¾"	7/8"	1½"	13¾"	1 in 10"
	(SA) 7mm WSM	22"	034011149	1,039.00	4	6 lbs. 12 oz.	42"	19¾"	7/8"	1½"	13¾"	1 in 9½"
	(SA) 300 WSM	22"	034011146	1,039.00	4	6 lbs. 12 oz.	42"	19¾"	7/8"	1½"	13¾"	1 in 10"
	(SA) 325 WSM	22"	034011177	1,039.00	4	6 lbs. 12 oz.	42"	19¾"	7/8"	1½"	13¾"	1 in 10"
BLR LIGHTWEIGHT '81 TAKEDOWN, LONG ACTION												
	(LA) 270 Win.	22"	034011124	\$1,019.00	5	7 lbs. 4 oz.	43"	19¾"	1"	1½"	14¼"	1 in 10"
	(LA) 30-06 Sprg.	22"	034011126	1,019.00	5	7 lbs. 4 oz.	43"	19¾"	1"	1½"	14¼"	1 in 10"
	(LA) 7mm Rem. Mag.	24"	034011127	1,019.00	4	7 lbs. 12 oz.	45"	20"	1"	1½"	14¼"	1 in 9½"
	(LA) 300 Win. Mag.	24"	034011129	1,019.00	4	7 lbs. 12 oz.	45"	20"	1"	1½"	14¼"	1 in 10"
BLR LIGHTWEIGHT '81, SHORT ACTION												
NEW	(SA) 223 Rem.	20"	034006108	\$879.00	5	6 lbs. 8 oz.	40"	17¾"	7/8"	1½"	13¾"	1 in 12"
	(SA) 22-250 Rem.	20"	034006109	879.00	5	6 lbs. 8 oz.	40"	17¾"	7/8"	1½"	13¾"	1 in 14"
	(SA) 243 Win.	20"	034006111	879.00	5	6 lbs. 8 oz.	40"	17¾"	7/8"	1½"	13¾"	1 in 10"
	(SA) 7mm-08 Rem.	20"	034006116	879.00	5	6 lbs. 8 oz.	40"	17¾"	7/8"	1½"	13¾"	1 in 9½"
	(SA) 308 Win.	20"	034006118	879.00	5	6 lbs. 8 oz.	40"	17¾"	7/8"	1½"	13¾"	1 in 12"
	(SA) 358 Win.	20"	034006120	879.00	5	6 lbs. 8 oz.	40"	17¾"	7/8"	1½"	13¾"	1 in 12"
	(SA) 450 Marlin	20"	034006150	879.00	4	7 lbs.	40"	17¾"	7/8"	1½"	13¾"	1 in 20"
	(SA) 270 WSM	22"	034006148	959.00	4	6 lbs. 12 oz.	42"	19¾"	7/8"	1½"	13¾"	1 in 10"
	(SA) 7mm WSM	22"	034006149	959.00	4	6 lbs. 12 oz.	42"	19¾"	7/8"	1½"	13¾"	1 in 9½"
	(SA) 300 WSM	22"	034006146	959.00	4	6 lbs. 12 oz.	42"	19¾"	7/8"	1½"	13¾"	1 in 10"
	(SA) 325 WSM	22"	034006177	959.00	4	6 lbs. 12 oz.	42"	19¾"	7/8"	1½"	13¾"	1 in 10"
BLR LIGHTWEIGHT '81, LONG ACTION												
	(LA) 270 Win.	22"	034006124	\$939.00	5	7 lbs. 4 oz.	43"	19¾"	1"	1½"	14¼"	1 in 10"
	(LA) 30-06 Sprg.	22"	034006126	939.00	5	7 lbs. 4 oz.	43"	19¾"	1"	1½"	14¼"	1 in 10"
	(LA) 7mm Rem. Mag.	24"	034006127	939.00	4	7 lbs. 12 oz.	45"	20"	1"	1½"	14¼"	1 in 9½"
	(LA) 300 Win. Mag.	24"	034006129	939.00	4	7 lbs. 12 oz.	45"	20"	1"	1½"	14¼"	1 in 10"

NOTE: *Total capacity includes one round in the chamber. **Weights listed are approximate. ***Measured from centerline of bore.

BLR EXTRA MAGAZINES

CALIBER	CODE NUMBER	SUGG. RETAIL	CALIBER	CODE NUMBER	SUGG. RETAIL
EXTRA MAGAZINES, SHORT ACTION CALIBERS			EXTRA MAGAZINES, LONG AND SHORT ACTION CALIBERS		
NEW 223 Rem.	112026008	\$69.99	270 Win.	112026024	\$69.99
243 Win.	112026011	69.99	30-06 Sprg.	112026026	69.99
308 Win.	112026012	69.99	7mm Rem. Mag.	112026027	69.99
22-250 Rem.	112026009	69.99	300 Win. Mag.	112026029	69.99
7mm-08 Rem.	112026016	69.99	325 WSM	112022067	69.99
270 WSM	112026030	69.99	358 Win.	112026042	69.99
300 WSM	112026041	69.99	450 Marlin	112026043	69.99
7mm WSM	112026031	69.99			



BAR

BAR® — MAGNUM POWER. AUTOLOADER ACCURACY.

The Browning BAR has everything you demand in an autoloader: Accuracy, fast handling and dependability. The multi-lug rotary bolt allows the BAR to fire magnum cartridges with bolt-action accuracy. The slick gas system softens recoil to reduce muzzle climb and improve follow-up shot speed and accuracy. The BAR is simply in a class of its own.



RECEIVER

The Safari model uses a richly blued one-piece ordnance steel receiver with scroll engraving. Stalker, ShortTrac® and LongTrac® models have an aircraft-grade aluminum alloy receiver. All BAR rifles are drilled and tapped for scope mounts. The bolt release lever is incorporated into the receiver.



ACTION

The BAR is a gas-operated autoloader with a high-strength, multiple-lug rotating bolt that locks directly into the barrel. Every cartridge loaded into the chamber of the BAR is surrounded by a recessed bolt face, which is encircled by the barrel and then surrounded by the receiver. A seven-lug bolt and precise breech-to-chamber relationship give the BAR exceptional accuracy and the strength to handle magnum loads. The strong and very rigid action bar/inertia block link-up improves accuracy by reducing barrel vibration. The buffering system reduces wear and stress on the rifle's mechanism.

All Browning firearms are shipped with a free locking device to assist in the safe storage of firearms.



MAGAZINE

Detachable box magazine with a unique hinged floorplate allows you to lower the floorplate, detach the magazine and snap in a full magazine in seconds.



ADJUSTABLE SHIM SYSTEM

ShortTrac® and LongTrac® BAR rifles include six shims that let you customize the drop at comb and cast on/off of the rifle to your ideal dimensions.



MAXIMUM GRIP

Camo composite BAR models combine checkered or overmolded gripping surfaces and Browning's proven Dura-Touch® Armor Coating for a sure hold and a sleek feel in all climate conditions.



THE BOSS® SYSTEM

The Ballistic Optimizing Shooting System is designed to squeeze maximum accuracy from the BAR. The tunable BOSS System easily dials-in barrel harmonics to precisely match the specific ammunition being fired to deliver amazingly tight groups. The BOSS System is available as an option on the BAR MK II Safari.

BOSS-CR

The BOSS-CR offers all the accuracy advantages of the original BOSS without the muzzle brake feature.

BAR LONGTRAC® ▶ OIL FINISH

BAR LongTrac, Left-Hand

RECEIVER - Aircraft-grade alloy · Satin nickel finish · High-relief engraving
 · Drilled and tapped for scope mounts
BARREL - Blued finish · Hammer-forged
ACTION - Gas-operated autoloader
 · Multi-lug rotary bolt · Detachable box magazine · Composite trigger guard and floorplate · Crossbolt safety

STOCK - Oil finish Grade II walnut
 · Stylized forearm · Checkered
 · Shim adjustable for cast on/off and drop at comb
FEATURES - Sling swivel studs installed
 · Interchangeable recoil pad



BAR LongTrac, Right-Hand

BAR SHORTTRAC® ▶ OIL FINISH

BAR ShortTrac, Left-Hand

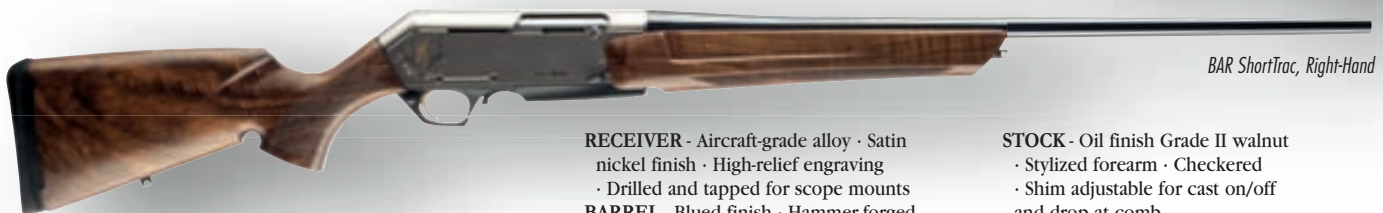

BAR ShortTrac, Right-Hand

RECEIVER - Aircraft-grade alloy · Satin nickel finish · High-relief engraving
 · Drilled and tapped for scope mounts
BARREL - Blued finish · Hammer-forged
ACTION - Gas-operated autoloader
 · Multi-lug rotary bolt · Detachable box magazine · Composite trigger guard and floorplate · Crossbolt safety

STOCK - Oil finish Grade II walnut
 · Stylized forearm · Checkered
 · Shim adjustable for cast on/off and drop at comb
FEATURES - Sling swivel studs installed
 · Interchangeable recoil pad



(SA) = Short Action, (LA) = Long Action

	CALIBER	BARREL LENGTH	CODE NUMBER	SUGG. RETAIL	*TOTAL CAPACITY	**AVG. WEIGHT	OVERALL LENGTH	SIGHT RADIUS	***DROP AT COMB	DROP AT HEEL	LENGTH OF PULL	RATE OF TWIST
BAR LONGTRAC, LEFT-HAND												
	(LA) 270 Win.	22"	031537224	\$1,179.00	5	6 lbs. 15 oz.	42"	—	5/8"	1 1/8"	13 3/8"	1 in 10"
	(LA) 30-06 Sprg.	22"	031537226	1,179.00	5	6 lbs. 15 oz.	42"	—	5/8"	1 1/8"	13 3/8"	1 in 10"
	(LA) 7mm Rem. Mag.	24"	031537227	1,269.00	4	7 lbs. 8 oz.	44"	—	5/8"	1 1/8"	13 3/8"	1 in 9 1/2"
	(LA) 300 Win. Mag.	24"	031537229	1,269.00	4	7 lbs. 8 oz.	44"	—	5/8"	1 1/8"	13 3/8"	1 in 10"
BAR LONGTRAC, RIGHT-HAND												
	(LA) 270 Win.	22"	031536224	\$1,119.00	5	6 lbs. 15 oz.	42"	—	5/8"	1 1/8"	13 3/8"	1 in 10"
	(LA) 30-06 Sprg.	22"	031536226	1,119.00	5	6 lbs. 15 oz.	42"	—	5/8"	1 1/8"	13 3/8"	1 in 10"
	(LA) 7mm Rem. Mag.	24"	031536227	1,229.00	4	7 lbs. 8 oz.	44"	—	5/8"	1 1/8"	13 3/8"	1 in 9 1/2"
	(LA) 300 Win. Mag.	24"	031536229	1,229.00	4	7 lbs. 8 oz.	44"	—	5/8"	1 1/8"	13 3/8"	1 in 10"
BAR SHORTTRAC, LEFT-HAND												
	(SA) 243 Win.	22"	031535211	\$1,179.00	5	6 lbs. 10 oz.	41 1/2"	—	5/8"	1 1/8"	13 3/4"	1 in 10"
	(SA) 7mm-08 Rem.	22"	031535216	1,179.00	5	6 lbs. 10 oz.	41 1/2"	—	5/8"	1 1/8"	13 3/4"	1 in 9 1/2"
	(SA) 308 Win.	22"	031535218	1,179.00	5	6 lbs. 10 oz.	41 1/2"	—	5/8"	1 1/8"	13 3/4"	1 in 12"
	(SA) 270 WSM	23"	031535248	1,269.00	4	7 lbs. 4 oz.	42 1/2"	—	5/8"	1 1/8"	13 3/4"	1 in 10"
	(SA) 7mm WSM	23"	031535249	1,269.00	4	7 lbs. 4 oz.	42 1/2"	—	5/8"	1 1/8"	13 3/4"	1 in 9 1/2"
	(SA) 300 WSM	23"	031535246	1,269.00	4	7 lbs. 4 oz.	42 1/2"	—	5/8"	1 1/8"	13 3/4"	1 in 10"
	(SA) 325 WSM	23"	031535277	1,269.00	4	7 lbs. 4 oz.	42 1/2"	—	5/8"	1 1/8"	13 3/4"	1 in 10"
BAR SHORTTRAC, RIGHT-HAND												
	(SA) 243 Win.	22"	031534211	\$1,119.00	5	6 lbs. 10 oz.	41 1/2"	—	5/8"	1 1/8"	13 3/4"	1 in 10"
	(SA) 7mm-08 Rem.	22"	031534216	1,119.00	5	6 lbs. 10 oz.	41 1/2"	—	5/8"	1 1/8"	13 3/4"	1 in 9 1/2"
	(SA) 308 Win.	22"	031534218	1,119.00	5	6 lbs. 10 oz.	41 1/2"	—	5/8"	1 1/8"	13 3/4"	1 in 12"
	(SA) 270 WSM	23"	031534248	1,229.00	4	7 lbs. 4 oz.	42 1/2"	—	5/8"	1 1/8"	13 3/4"	1 in 10"
	(SA) 7mm WSM	23"	031534249	1,229.00	4	7 lbs. 4 oz.	42 1/2"	—	5/8"	1 1/8"	13 3/4"	1 in 9 1/2"
	(SA) 300 WSM	23"	031534246	1,229.00	4	7 lbs. 4 oz.	42 1/2"	—	5/8"	1 1/8"	13 3/4"	1 in 10"
	(SA) 325 WSM	23"	031534277	1,229.00	4	7 lbs. 4 oz.	42 1/2"	—	5/8"	1 1/8"	13 3/4"	1 in 10"

NOTE: *Total capacity includes one round in the chamber. **Weights listed are approximate. ***Measured from centerline of bore.

BAR SHORTTRAC® ▶ DURA-TOUCH® ARMOR COATING



NEW

NEW FOR 2010
Mossy Oak Break-Up Infinity camo will be available on this firearm.

MOSSY OAK
BREAK-UP
INFINITY

SHORT TRAC

DURA-TOUCH
Armor Coating

WSM

RECEIVER - Aircraft-grade alloy
· Drilled and tapped for scope mounts
BARREL - Hammer-forged
ACTION - Gas-operated autoloader
· Multi-lug rotary bolt · Detachable box magazine · Composite trigger guard and floorplate · Crossbolt safety

STOCK - Composite · Dura-Touch® Armor Coating · Mossy Oak® camo finishes
· Gripping panels · Shim adjustable for cast on/off and drop at comb
FEATURES - Sling swivel studs installed
· Interchangeable recoil pad

BAR LONGTRAC® BREAK-UP® INFINITY ▶ DURA-TOUCH® ARMOR COATING



NEW

NEW FOR 2010
Mossy Oak Break-Up Infinity camo will replace New Break-Up camo on this Browning firearm.

MOSSY OAK
BREAK-UP
INFINITY

RECEIVER - Aircraft-grade alloy
· Drilled and tapped for scope mounts
BARREL - Hammer-forged
ACTION - Gas-operated autoloader
· Multi-lug rotary bolt · Detachable box magazine · Composite trigger guard and floorplate · Crossbolt safety

STOCK - Composite · Dura-Touch® Armor Coating · Mossy Oak® Break-Up® Infinity camo finish
· Gripping panels · Shim adjustable for cast on/off and drop at comb
FEATURES - Sling swivel studs installed · Interchangeable recoil pad

(SA) = Short Action, (LA) = Long Action

	CALIBER	BARREL LENGTH	CODE NUMBER	SUGG. RETAIL	*TOTAL CAPACITY	**AVG. WEIGHT	OVERALL LENGTH	SIGHT RADIUS	***DROP AT COMB	DROP AT HEEL	LENGTH OF PULL	RATE OF TWIST
BAR SHORTTRAC, MOSSY OAK NEW BREAK-UP AND MOSSY OAK BREAK-UP INFINITY												
NEW	MOINF (SA) 243 Win.	22"	031022211	\$1,269.00	5	6 lbs. 10 oz.	41½"	—	⅝"	1½"	13⅝"	1 in 10"
NEW	MOINF (SA) 7mm-08 Rem.	22"	031022216	1,269.00	5	6 lbs. 10 oz.	41½"	—	⅝"	1½"	13⅝"	1 in 9½"
NEW	MOINF (SA) 308 Win.	22"	031022218	1,269.00	5	6 lbs. 10 oz.	41½"	—	⅝"	1½"	13⅝"	1 in 12"
	MONBU (SA) 270 WSM	23"	031328248	1,379.00	4	7 lbs. 4 oz.	42½"	—	⅝"	1½"	13⅝"	1 in 10"
NEW	MOINF (SA) 270 WSM	23"	031022248	1,379.00	4	7 lbs. 4 oz.	42½"	—	⅝"	1½"	13⅝"	1 in 10"
NEW	MOINF (SA) 7mm WSM	23"	031022249	1,379.00	4	7 lbs. 4 oz.	42½"	—	⅝"	1½"	13⅝"	1 in 9½"
	MONBU (SA) 300 WSM	23"	031328246	1,379.00	4	7 lbs. 4 oz.	42½"	—	⅝"	1½"	13⅝"	1 in 10"
NEW	MOINF (SA) 300 WSM	23"	031022246	1,379.00	4	7 lbs. 4 oz.	42½"	—	⅝"	1½"	13⅝"	1 in 10"
	MONBU (SA) 325 WSM	23"	031328277	1,379.00	4	7 lbs. 4 oz.	42½"	—	⅝"	1½"	13⅝"	1 in 10"
NEW	MOINF (SA) 325 WSM	23"	031022277	1,379.00	4	7 lbs. 4 oz.	42½"	—	⅝"	1½"	13⅝"	1 in 10"
BAR LONGTRAC, MOSSY OAK BREAK-UP INFINITY												
NEW	MOINF (LA) 270 Win.	22"	031023224	\$1,269.00	5	6 lbs. 15 oz.	42"	—	⅝"	1½"	13⅝"	1 in 10"
NEW	MOINF (LA) 30-06 Sprg.	22"	031023226	1,269.00	5	6 lbs. 15 oz.	42"	—	⅝"	1½"	13⅝"	1 in 10"
NEW	MOINF (LA) 7mm Rem. Mag.	24"	031023227	1,379.00	4	7 lbs. 8 oz.	44"	—	⅝"	1½"	13⅝"	1 in 9½"
NEW	MOINF (LA) 300 Win. Mag.	24"	031023229	1,379.00	4	7 lbs. 8 oz.	44"	—	⅝"	1½"	13⅝"	1 in 10"
BAR SHORTTRAC STALKER												
	(SA) 243 Win.	22"	031330211	\$1,149.00	5	6 lbs. 10 oz.	41½"	—	⅝"	1½"	13⅝"	1 in 10"
	(SA) 7mm-08 Rem.	22"	031330216	1,149.00	5	6 lbs. 10 oz.	41½"	—	⅝"	1½"	13⅝"	1 in 9½"
	(SA) 308 Win.	22"	031330218	1,149.00	5	6 lbs. 10 oz.	41½"	—	⅝"	1½"	13⅝"	1 in 12"
	(SA) 270 WSM	23"	031330248	1,239.00	4	7 lbs. 4 oz.	42½"	—	⅝"	1½"	13⅝"	1 in 10"
	(SA) 7mm WSM	23"	031330249	1,239.00	4	7 lbs. 4 oz.	42½"	—	⅝"	1½"	13⅝"	1 in 9½"
	(SA) 300 WSM	23"	031330246	1,239.00	4	7 lbs. 4 oz.	42½"	—	⅝"	1½"	13⅝"	1 in 10"
	(SA) 325 WSM	23"	031330277	1,239.00	4	7 lbs. 4 oz.	42½"	—	⅝"	1½"	13⅝"	1 in 10"
BAR LONGTRAC STALKER												
	(LA) 270 Win.	22"	031331224	\$1,149.00	5	6 lbs. 15 oz.	42"	—	⅝"	1½"	13⅝"	1 in 10"
	(LA) 30-06 Sprg.	22"	031331226	1,149.00	5	6 lbs. 15 oz.	42"	—	⅝"	1½"	13⅝"	1 in 10"
	(LA) 7mm Rem. Mag.	24"	031331227	1,239.00	4	7 lbs. 8 oz.	44"	—	⅝"	1½"	13⅝"	1 in 9½"
	(LA) 300 Win. Mag.	24"	031331229	1,239.00	4	7 lbs. 8 oz.	44"	—	⅝"	1½"	13⅝"	1 in 10"

NOTE: *Total capacity includes one round in the chamber. **Weights listed are approximate. ***Measured from centerline of bore.

MOSSY OAK
BREAK-UP

LONG TRAC

DURA-TOUCH
Armor Coating

BAR SHORTTRAC® STALKER ▶ NON-GLARE COMPOSITE FINISH



SHORT TRAC



RECEIVER - Aircraft-grade alloy · Matte blued finish · Drilled and tapped for scope mounts
BARREL - Matte blued finish · Hammer-forged
ACTION - Gas-operated autoloader · Multi-lug rotary bolt · Detachable box magazine
 · Composite trigger guard and floorplate
 · Crossbolt safety

STOCK - Composite · Matte black finish
 · Gripping panels · Shim adjustable for cast on/off and drop at comb
FEATURES - Sling swivel studs installed
 · Interchangeable recoil pad

BAR LONGTRAC® STALKER ▶ NON-GLARE COMPOSITE FINISH

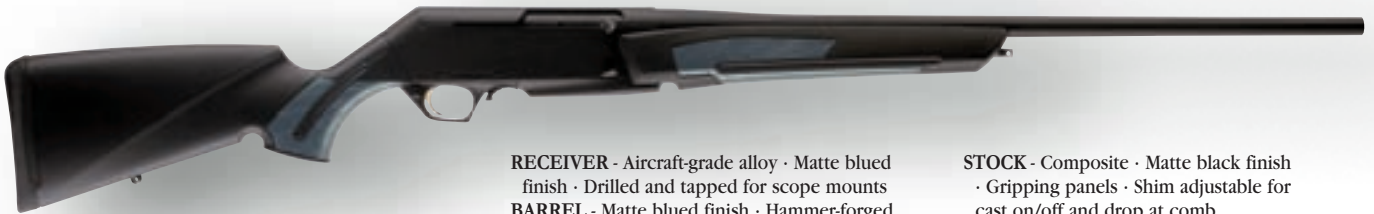

LONG TRAC

RECEIVER - Aircraft-grade alloy · Matte blued finish · Drilled and tapped for scope mounts
BARREL - Matte blued finish · Hammer-forged
ACTION - Gas-operated autoloader · Multi-lug rotary bolt · Detachable box magazine
 · Composite trigger guard and floorplate
 · Crossbolt safety

STOCK - Composite · Matte black finish
 · Gripping panels · Shim adjustable for cast on/off and drop at comb
FEATURES - Sling swivel studs installed
 · Interchangeable recoil pad



BAR SHORTTRAC® AND LONGTRAC® RECOIL PADS (FOR WOOD AND COMPOSITE MODELS)

DESCRIPTION	CODE #	SUGG. RETAIL
1/2" BAR ST/LT Recoil Pad	11450	\$29.99
3/4" BAR ST/LT Recoil Pad	11451	29.99
1" BAR ST/LT Recoil Pad	11452	29.99

PAD - Black, polymer cushion
TOP INSERT - Hard polypropylene
REINFORCEMENT - Black, glass-fiber reinforced synthetic
THICKNESS - Choice of 1/2", 3/4" or 1"

BAR EXTRA MAGAZINES

CALIBER	CODE NUMBER	SUGG. RETAIL
EXTRA MAGAZINES, BAR MARK II, SAFARI AND LIGHTWEIGHT STALKER		
243 Win. and 308 Win.	112025011	\$69.99
270 WSM	112025041	69.99
7mm WSM	112025042	69.99
300 WSM	112025030	69.99
EXTRA MAGAZINES, BAR LONGTRAC, BAR MARK II, SAFARI AND LIGHTWEIGHT STALKER		
270 Win., 25-06 Rem., 30-06 Sprg.	112025024	\$69.99
300 Win. Mag.	112025029	69.99
338 Win. Mag.	112025031	69.99
7mm Rem. Mag.	112025027	69.99
EXTRA MAGAZINES, BAR SHORTTRAC		
243 Win. and 308 Win.	112025050	\$69.99
7mm-08 Rem.	112025051	69.99
270 WSM	112025055	69.99
7mm WSM	112025055	69.99
300 WSM	112025055	69.99
325 WSM	112025052	69.99

THE BROWNING BAR. THE AUTOLOADER HUNTERS WANT.

With more than ten calibers and ten models to choose from, there is a flat-shooting Browning BAR autoloader to fit your needs. From models with an elegant satin nickel receiver finish to utilitarian models that are fully camouflaged for additional concealment, all retain the same rugged and reliable reputation that has made the BAR a favorite for decades.

BAR LIGHTWEIGHT STALKER ▶ NON-GLARE COMPOSITE FINISH



RECEIVER - Aircraft-grade alloy
 · Matte blued finish · Drilled and tapped for scope mounts
BARREL - Matte blued finish
 · Hammer-forged · Adjustable open sights

ACTION - Gas-operated autoloader
 · Multi-lug rotary bolt · Detachable box magazine · Crossbolt safety
STOCK - Composite · Matte black finish · Checkered
FEATURES - Sling swivel studs installed · Recoil pad

BAR MK II SAFARI ▶ GLOSS FINISH



RECEIVER - Steel · Blued finish · Scroll engraving · Drilled and tapped for scope mounts
BARREL - Blued finish · Hammer-forged
ACTION - Gas-operated autoloader
 · Multi-lug rotary bolt · Detachable box magazine · Crossbolt safety
STOCK - Select gloss finish walnut
 · Rounded forearm · Checkered
FEATURES - Sling swivel studs installed
 · Recoil pad · Available with BOSS® System, BOSS-CR optional · Scope and mounts not included

CALIBER	BARREL LENGTH	CODE NUMBER	SUGG. RETAIL	*TOTAL CAPACITY	**AVG. WEIGHT	OVERALL LENGTH	SIGHT RADIUS	***DROP AT COMB	DROP AT HEEL	LENGTH OF PULL	RATE OF TWIST
BAR LIGHTWEIGHT STALKER											
243 Win.	20"	031008111	\$1,119.00	5	6 lbs. 14 oz.	41"	16"	3/4"	1 1/8"	13 3/4"	1 in 10"
308 Win.	20"	031008118	1,119.00	5	6 lbs. 14 oz.	41"	16"	3/4"	1 1/8"	13 3/4"	1 in 12"
270 WSM	23"	031008148	1,229.00	4	7 lbs. 1 oz.	44"	18 1/2"	3/4"	1 1/8"	13 3/4"	1 in 10"
7mm WSM	23"	031008149	1,229.00	4	7 lbs. 1 oz.	44"	18 1/2"	3/4"	1 1/8"	13 3/4"	1 in 9 1/2"
300 WSM	23"	031008146	1,229.00	4	7 lbs. 1 oz.	44"	18 1/2"	3/4"	1 1/8"	13 3/4"	1 in 10"
270 Win.	22"	031008124	1,119.00	5	7 lbs.	43"	17 1/2"	3/4"	1 1/8"	13 3/4"	1 in 10"
30-06 Sprg.	22"	031008126	1,119.00	5	7 lbs.	43"	17 1/2"	3/4"	1 1/8"	13 3/4"	1 in 10"
300 Win. Mag.	24"	031008129	1,229.00	4	7 lbs. 2 oz.	45"	19 1/2"	3/4"	1 1/8"	13 3/4"	1 in 10"
338 Win. Mag.	24"	031008131	1,229.00	4	7 lbs. 2 oz.	45"	19 1/2"	3/4"	1 1/8"	13 3/4"	1 in 10"
BAR MK II SAFARI, NO SIGHTS											
243 Win.	22"	031001211	\$1,139.00	5	7 lbs. 8 oz.	43"	—	3/4"	1 1/8"	13 3/4"	1 in 10"
308 Win.	22"	031001218	1,139.00	5	7 lbs. 8 oz.	43"	—	3/4"	1 1/8"	13 3/4"	1 in 12"
25-06 Rem.	24"	031001223	1,139.00	5	7 lbs. 10 oz.	45"	—	3/4"	1 1/8"	13 3/4"	1 in 10"
270 Win.	22"	031001224	1,139.00	5	7 lbs. 8 oz.	43"	—	3/4"	1 1/8"	13 3/4"	1 in 10"
30-06 Sprg.	22"	031001226	1,139.00	5	7 lbs. 8 oz.	43"	—	3/4"	1 1/8"	13 3/4"	1 in 10"
7mm Rem. Mag.	24"	031001227	1,229.00	4	8 lbs. 10 oz.	45"	—	3/4"	1 1/8"	13 3/4"	1 in 9 1/2"
300 Win. Mag.	24"	031001229	1,229.00	4	8 lbs. 10 oz.	45"	—	3/4"	1 1/8"	13 3/4"	1 in 10"
338 Win. Mag.	24"	031001231	1,229.00	4	8 lbs. 10 oz.	45"	—	3/4"	1 1/8"	13 3/4"	1 in 10"
BAR MK II SAFARI, WITH BOSS (SHOWN)											
270 WSM	23"	031001348	\$1,359.00	4	8 lbs. 4 oz.	44"	—	3/4"	1 1/8"	13 3/4"	1 in 10"
7mm WSM	23"	031001349	1,359.00	4	8 lbs. 4 oz.	44"	—	3/4"	1 1/8"	13 3/4"	1 in 9 1/2"
300 WSM	23"	031001346	1,359.00	4	8 lbs. 4 oz.	44"	—	3/4"	1 1/8"	13 3/4"	1 in 10"
270 Win.	22"	031001324	1,259.00	5	7 lbs. 6 oz.	43"	—	3/4"	1 1/8"	13 3/4"	1 in 10"
30-06 Sprg.	22"	031001326	1,259.00	5	7 lbs. 6 oz.	43"	—	3/4"	1 1/8"	13 3/4"	1 in 10"
7mm Rem. Mag.	24"	031001327	1,359.00	4	8 lbs. 6 oz.	45"	—	3/4"	1 1/8"	13 3/4"	1 in 9 1/2"
300 Win. Mag.	24"	031001329	1,359.00	4	8 lbs. 6 oz.	45"	—	3/4"	1 1/8"	13 3/4"	1 in 10"
338 Win. Mag.	24"	031001331	1,359.00	4	8 lbs. 6 oz.	45"	—	3/4"	1 1/8"	13 3/4"	1 in 10"

NOTE: *Total capacity includes one round in the chamber. **Weights listed are approximate. ***Measured from centerline of bore.

T-BOLT

T-BOLT™ — QUALITY RIMFIRE ACCURACY. Unique and fun to shoot, the Browning T-Bolt is one of the highest-quality rimfire rifles you can buy. The straight-pull bolt cycles fast and locks-up solidly for unmatched accuracy. The T-Bolt is a gem that exceeds expectations with a level of fit and finish seldom found in a rimfire rifle, translating into impressive performance with each squeeze of the trigger.

STOCK

Available in both right- and left-hand models, T-Bolt rifle stocks are full-size to comfortably fit adults. Durable Composite models feature a Monte Carlo comb and include magazine storage in the buttstock. Walnut stocked Sporter models feature trim dimensions with a satin finish and cut checkering. Walnut Target/Varmint models feature a Monte Carlo comb and wide forearm for stability on the bench. All models include dual action screws for solid attachment, sling swivel studs and a synthetic buttplate.



TRIGGER

The three-lever trigger design combined with a short-travel firing pin give a crisp break, quick lock time, no take-up and minimal overtravel. It is also externally adjustable for pull weight.

ACTION

Receiver is machined from steel barstock. Features crossbolt lockup and an enlarged bolt handle pivot point moved forward for smoother action. The mainspring runs directly through the massive pivot pin. Cocking effort is split between opening and closing for ease of operation. The bolt features dual extractors and a red cocking indicator band. Right-side ejection on both right- and left-hand models.



SAFETY

Top-tang, thumb operated two-position safety can be operated without changing from a shooting grip.

BARREL

Target/Varmint models feature a 22" heavy varmint profile. T-Bolt Sporter models feature a 22" medium sporter profile. All are free-floating and have a semi-match chamber and target muzzle crown.

SIGHTS

Receiver is drilled and tapped for scope mounts (scope not included). See page 128 for scope rings and bases for T-Bolt rifles.

All Browning firearms are shipped with a free locking device to assist in the safe storage of firearms.



.22 Long Rifle



17 HMR/
22 WMR



MAGAZINE

Patent pending Double Helix® rotary box magazine. Torsion spring driven interlocking gears on the Double Helix magazine provide added reliability plus easy loading and unloading. 10-round capacity.

CALIBER	CODE NUMBER	SUGG. RETAIL
22 L.R.	112055290	\$49.99
17 HMR/22 WMR	112055291	49.99

T-BOLT COMPOSITE SPORTER ▶ NON-GLARE COMPOSITE FINISH

(Left-Hand model not shown)



RECEIVER - Steel · Blued finish · Drilled and tapped for scope mounts
BARREL - Medium sporter · Blued finish · Free-floating · Semi-match chamber · Recessed crown
ACTION - Straight pull bolt-action · Top-tang safety · Adjustable trigger · Right- and left-hand models have right side ejection

STOCK - Composite · Textured gripping surfaces · Matte black · Spare magazine storage compartment
FEATURES - Sling swivel studs installed · Scope and mounts not included

CALIBER	BARREL LENGTH	CODE NUMBER	SUGG. RETAIL	*TOTAL CAPACITY	**AVG. WEIGHT	OVERALL LENGTH	SIGHT RADIUS	***DROP AT COMB	DROP AT HEEL	LENGTH OF PULL	RATE OF TWIST
T-BOLT COMPOSITE SPORTER (SHOWN)											
22 L.R.	22"	025179202	\$709.00	11	4 lbs. 9 oz.	40¾"	—	⅝"	⅝"	13½"	1 in 16"
22 WMR	22"	025179204	749.00	11	4 lbs. 9 oz.	40¾"	—	⅝"	⅝"	13½"	1 in 16"
17 HMR	22"	025179270	749.00	11	4 lbs. 9 oz.	40¾"	—	⅝"	⅝"	13½"	1 in 9"
T-BOLT COMPOSITE SPORTER, LEFT-HAND											
22 L.R.	22"	025186202	\$719.00	11	4 lbs. 9 oz.	40¾"	—	⅝"	⅝"	13½"	1 in 16"
22 WMR	22"	025186204	759.00	11	4 lbs. 9 oz.	40¾"	—	⅝"	⅝"	13½"	1 in 16"
17 HMR	22"	025186270	759.00	11	4 lbs. 9 oz.	40¾"	—	⅝"	⅝"	13½"	1 in 9"
T-BOLT COMPOSITE TARGET/VARMINT (SHOWN)											
22 L.R.	22"	025180202	\$749.00	11	5 lbs. 2 oz.	40¾"	—	⅝"	⅝"	13½"	1 in 16"
22 WMR	22"	025180204	779.00	11	5 lbs. 2 oz.	40¾"	—	⅝"	⅝"	13½"	1 in 16"
17 HMR	22"	025180270	779.00	11	5 lbs. 2 oz.	40¾"	—	⅝"	⅝"	13½"	1 in 9"
T-BOLT COMPOSITE TARGET/VARMINT, LEFT-HAND											
22 L.R.	22"	025187202	\$759.00	11	5 lbs. 2 oz.	40¾"	—	⅝"	⅝"	13½"	1 in 16"
22 WMR	22"	025187204	789.00	11	5 lbs. 2 oz.	40¾"	—	⅝"	⅝"	13½"	1 in 16"
17 HMR	22"	025187270	789.00	11	5 lbs. 2 oz.	40¾"	—	⅝"	⅝"	13½"	1 in 9"
T-BOLT SPORTER											
22 L.R.	22"	025175202	\$709.00	11	4 lbs. 14 oz.	40¾"	—	⅝"	⅝"	13½"	1 in 16"
22 WMR	22"	025175204	749.00	11	4 lbs. 14 oz.	40¾"	—	⅝"	⅝"	13½"	1 in 16"
17 HMR	22"	025175270	749.00	11	4 lbs. 14 oz.	40¾"	—	⅝"	⅝"	13½"	1 in 9"
T-BOLT SPORTER, LEFT-HAND											
22 L.R.	22"	025184202	\$719.00	11	4 lbs. 14 oz.	40¾"	—	⅝"	⅝"	13½"	1 in 16"
22 WMR	22"	025184204	759.00	11	4 lbs. 14 oz.	40¾"	—	⅝"	⅝"	13½"	1 in 16"
17 HMR	22"	025184270	759.00	11	4 lbs. 14 oz.	40¾"	—	⅝"	⅝"	13½"	1 in 9"
T-BOLT TARGET/VARMINT (SHOWN)											
22 L.R.	22"	025176202	\$749.00	11	5 lbs. 8 oz.	40¾"	—	⅝"	⅝"	13½"	1 in 16"
22 WMR	22"	025176204	779.00	11	5 lbs. 8 oz.	40¾"	—	⅝"	⅝"	13½"	1 in 16"
17 HMR	22"	025176270	779.00	11	5 lbs. 8 oz.	40¾"	—	⅝"	⅝"	13½"	1 in 9"
T-BOLT TARGET/VARMINT, LEFT-HAND											
22 L.R.	22"	025185202	\$759.00	11	5 lbs. 8 oz.	40¾"	—	⅝"	⅝"	13½"	1 in 16"
22 WMR	22"	025185204	789.00	11	5 lbs. 8 oz.	40¾"	—	⅝"	⅝"	13½"	1 in 16"
17 HMR	22"	025185270	789.00	11	5 lbs. 8 oz.	40¾"	—	⅝"	⅝"	13½"	1 in 9"

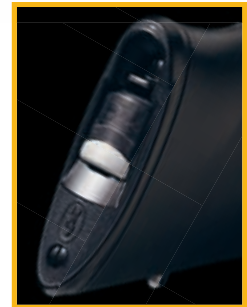

Buttstock Magazine Storage



NOTE: *Total capacity includes one round in the chamber. **Weights listed are approximate. ***Measured from centerline of bore.

T-BOLT COMPOSITE TARGET/VARMINT ▶ NON-GLARE COMPOSITE FINISH

(Left-Hand model not shown)



- RECEIVER - Steel · Blued finish
- Drilled and tapped for scope mounts
- BARREL - Medium target · Blued finish
- Free-floating · Semi-match chamber
- Recessed crown
- ACTION - Straight pull bolt-action
- Top-tang safety · Adjustable trigger
- Right- and left-hand models have right side ejection
- STOCK - Composite · Textured gripping surfaces · Matte black · Spare magazine storage compartment
- FEATURES - Sling swivel studs installed
- Scope and mounts not included

T-BOLT SPORTER ▶ SATIN FINISH

T-Bolt Sporter, Right-Hand



T-Bolt Sporter, Left-Hand

- RECEIVER - Steel · Blued finish
- Drilled and tapped for scope mounts
- BARREL - Medium sporter · Blued finish
- Free-floating · Semi-match chamber
- Recessed crown

- ACTION - Straight pull bolt-action
- Top-tang safety · Adjustable trigger
- Right- and left-hand models have right side ejection
- STOCK - Satin finish walnut · Checkered
- FEATURES - Sling swivel studs installed



T-BOLT TARGET/VARMINT ▶ SATIN FINISH

(Left-Hand model not shown)



- RECEIVER - Steel · Blued finish · Drilled and tapped for scope mounts
- BARREL - Medium target · Blued finish
- Free-floating · Semi-match chamber
- Recessed crown
- ACTION - Straight pull bolt-action · Top-tang safety · Adjustable trigger
- Right- and left-hand models have right side ejection

- STOCK - Satin finish walnut
- Monte Carlo comb · Wide fore-end · Checkered
- FEATURES - Sling swivel studs installed · Scope and mounts not included

BL-22

BL-22™: A RIMFIRE FOR EVERY GENERATION.

There isn't a better built, more versatile lever-action rimfire rifle than the BL-22.

All Browning firearms are shipped with a free locking device to assist in the safe storage of firearms.

- ACTION** Short-throw lever-action travels through an arc of only 33° and carries the trigger with it. This prevents finger pinch between lever and trigger on the upward swing.
- RECEIVER** Forged and milled from solid steel. The grooved receiver accepts most grooved or tip-off type mounts or receiver sights.
- SIGHTS** Precision, adjustable folding leaf rear sight and raised bead front sight.
- BARREL** Recessed muzzle to preserve accuracy.
- TRIGGER** Clean and crisp without creep. Grade II models have a gold colored trigger.
- SAFETY** A disconnect system is designed to prevent firing until the lever and breech are fully closed.
- MAGAZINE** Designed to handle 22 caliber rimfire ammunition in any combination in the tubular magazine. Magazine capacity is 15 Long Rifle or up to 22 Short cartridges.
- STOCK AND FOREARM** Forearm and straight-grip buttstock are shaped from American walnut. Cut checkering featured on Grade II models.

BL-22 FULL LINE DEALER, GRADE II OCTAGON ▶ SATIN FINISH



RECEIVER - Steel · Satin nickel finish
 · Grooved for scope mounts · Scroll engraved
BARREL - Octagonal · Blued finish
 · Recessed crown
ACTION - Lever-action · Short 33° throw
 · ¾ length tubular magazine · Gold-colored trigger

STOCK - Satin finish American walnut
 · Straight grip · Cut checkering
FEATURES - Adjustable sights with front gold bead · Available only from Browning Full Line and Medallion Dealers

BL-22 FULL LINE DEALER, GRADE I AND II ▶ SATIN FINISH



RECEIVER - Steel · Satin nickel finish · Grooved for scope mounts · Grade II is scroll engraved
BARREL - Blued finish · Recessed crown
ACTION - Lever-action · Short 33° throw · Tubular magazine · Grade II has gold-colored trigger

STOCK - Satin finish American walnut
 · Straight grip · Grade II has cut checkering
FEATURES - Adjustable sights with front bead · Available only from Browning Full Line and Medallion Dealers

BL-22 GRADE I AND II ▶ GLOSS FINISH



RECEIVER - Steel · Blued finish · Grooved for scope mounts · Grade II is scroll engraved
BARREL - Blued finish · Recessed crown
ACTION - Lever-action · Short 33° throw · Tubular magazine · Grade II has gold-colored trigger

STOCK - Gloss finish American walnut · Straight grip · Grade II has cut checkering
FEATURES - Adjustable sights

	CALIBER	BARREL LENGTH	CODE NUMBER	SUGG. RETAIL	*TOTAL CAPACITY	**AVG. WEIGHT	OVERALL LENGTH	SIGHT RADIUS	***DROP AT COMB	DROP AT HEEL	LENGTH OF PULL	RATE OF TWIST
BL-22 FULL LINE DEALER, GRADE II OCTAGON												
	22 S, L & L.R.	24"	024105155	\$899.00	15 L.R.	5 lbs. 4 oz.	40¾"	19⅜"	7/8"	1½"	13½"	1 in 16"
BL-22 FULL LINE DEALER, GRADE I AND II												
	Grade I 22 S, L & L.R.	20"	024107102	\$599.00	15 L.R.	5 lbs.	36¾"	15⅜"	7/8"	1½"	13½"	1 in 16"
	Grade II 22 S, L & L.R.	20"	024108102	679.00	15 L.R.	5 lbs.	36¾"	15⅜"	7/8"	1½"	13½"	1 in 16"
BL-22 GRADE I AND II												
	Grade I 22 S, L & L.R.	20"	024100103	\$559.00	15 L.R.	5 lbs.	36¾"	15⅜"	7/8"	1½"	13½"	1 in 16"
	Grade II 22 S, L & L.R.	20"	024101103	639.00	15 L.R.	5 lbs.	36¾"	15⅜"	7/8"	1½"	13½"	1 in 16"

NOTE: *Total capacity includes one round in the chamber. **Weights listed are approximate. ***Measured from centerline of bore.

SA-22

ACTION

Takedown autoloader with bottom ejection.

RECEIVER

Grade I is engraved with scroll design and a polished, blued finish. Grade VI models are available in polished blued or satin grayed finish.

ENGRAVING

Grade VI models are deeply engraved with game scenes. Game figures are 24 karat gold-plated.

SIGHTS

Gold bead front and adjustable, folding leaf rear.

TRIGGER

Blued on Grade I. Gold on Grade VI.

BARREL

Drilled and tapped to accept a scope mount.

SAFETY

Manual trigger-blocking safety is mounted on the trigger guard.

MAGAZINE

Tubular. Capacity: 11 Long Rifle cartridges.

STOCK AND FOREARM

Select American walnut is checkered with a polished gloss finish.

A TRIBUTE TO THE GENIUS OF JOHN M. BROWNING.

The Browning SA-22 is a timeless firearm from the most famous gun maker that ever lived. The genius of John M. Browning lay in his elegantly simple and straightforward design philosophy. An SA-22 allows you to experience his ingenuity firsthand.

All Browning firearms are shipped with a free locking device to assist in the safe storage of firearms.

SEMI-AUTO 22 GRADE I ▶ GLOSS FINISH



RECEIVER - Steel · Takedown design
· Polished blued finish · Scroll engraving
BARREL - Polished blued finish · Drilled and tapped for scope mounts

ACTION - Autoloading · Bottom ejection
· Tubular magazine · Crossbolt safety
STOCK - Gloss finish select American walnut · Checkered
FEATURES - Adjustable sights with gold bead front

SEMI-AUTO 22 GRADE VI ▶ GLOSS FINISH



RECEIVER - Steel · Takedown design
· Polished blued or satin grayed finish
· Game scene engraving with 24 karat gold accents

BARREL - Polished blued finish
· Drilled and tapped for scope mounts
ACTION - Autoloading · Bottom ejection
· Tubular magazine · Crossbolt safety
STOCK - Gloss finish select American walnut · Checkered
FEATURES - Adjustable sights with gold bead front



The grayed receiver of the Semi-Auto 22 Grade VI is adorned with gold animal scenes.



The Semi-Auto 22 can be quickly taken down to a compact length of only 19 9/16" for storage or packing.

	CALIBER	BARREL LENGTH	CODE NUMBER	SUGG. RETAIL	*TOTAL CAPACITY	**AVG. WEIGHT	OVERALL LENGTH	SIGHT RADIUS	***DROP AT COMB	DROP AT HEEL	LENGTH OF PULL	RATE OF TWIST
SEMI-AUTO 22 GRADE I												
	22 L.R.	19 3/8"	021001102	\$659.00	11	5 lbs. 3 oz.	37"	16 3/4"	1 3/16"	2 5/8"	13 3/4"	1 in 16"
SEMI-AUTO 22 GRADE VI												
	Blued	22 L.R.	021002102	\$1,419.00	11	5 lbs. 3 oz.	37"	16 3/4"	1 3/16"	2 5/8"	13 3/4"	1 in 16"
	Grayed	22 L.R.	021003102	1,419.00	11	5 lbs. 3 oz.	37"	16 3/4"	1 3/16"	2 5/8"	13 3/4"	1 in 16"

NOTE: *Total capacity includes one round in the chamber. **Weights listed are approximate. ***Measured from centerline of bore.

BUCK MARK RIFLE



SIGHTS The Sporter model features a TRUGLO®/Marble's® fiber-optic sight system.

BARREL Sporter model features lightweight, tapered sporter-weight barrel. Target models feature a steel bull barrel. The chambers in every Buck Mark Rifle barrel are hand-reamed and muzzle crowns are recessed to protect them from damage that could degrade accuracy.



SAFETY

Large manual thumb safety.

MAGAZINE RELEASE

Positioned adjacent to the trigger guard for convenient operation.



MAGAZINE

Magazines are interchangeable with the Buck Mark pistol. The magazine body is heat-treated for long-term feeding reliability and long life. Our coil spring provides a consistent follower angle. 10-round capacity.

TRIGGER

The trigger is light, crisp and has less creep before it breaks and far less overtravel after breaking than other rimfires.



ACTION

The straight blowback design offers enhanced simplicity and reliability.

FRAME

Machined to exacting tolerances from a solid billet of 7075-T6 aluminum. The stock structure is a part of the pistol frame, reducing weight and the number of parts.

SLIDE

Built-in recess and raised side panels for an improved cocking grip. The convenient manual slide release is easily operated with the shooting or support hand.

All Browning firearms are shipped with a free locking device to assist in the safe storage of firearms.





BUCK MARK® RIFLES. EASY HANDLING RIMFIRES.

Quick to your shoulder and fun to shoot, the compact Browning Buck Mark Rifle is based on the popular pistol that shares its name. These lightweight rifles are easy to load and shoot for every member of the family. A Buck Mark Rifle is equally adept hunting squirrels or plinking swinging targets. The Buck Mark Rifle is still made in the USA.

BUCK MARK FULL LINE DEALER TARGET GRAY LAMINATE RIFLE ▶ SATIN FINISH



RECEIVER - Alloy · Matte blued finish
 BARREL - Heavy bull · Matte blued finish
 · Target crown
 ACTION - Blowback · Single-action
 trigger · Detachable magazine

STOCK - Laminated gray satin finish hardwood
 FEATURES - Integral scope rail
 · Available only from Browning Full Line
 and Medallion Dealers

BUCK MARK TARGET RIFLE ▶ OIL FINISH



RECEIVER - Alloy · Matte blued finish
 BARREL - Heavy bull · Matte blued
 finish · Target crown
 ACTION - Blowback · Single-action
 trigger · Detachable magazine

STOCK - Oil finish walnut
 FEATURES - Integral scope rail
 · Electronic sight not included

BUCK MARK SPORTER RIFLE ▶ OIL FINISH



RECEIVER - Alloy · Matte blued finish
 BARREL - Tapered sporter · Matte blued
 finish · Target crown
 ACTION - Blowback · Single-action
 trigger · Detachable magazine

STOCK - Oil finish walnut
 FEATURES - TRUGLO®/Marble's® adjustable
 fiber-optic sights · Integral scope rail

	CALIBER	BARREL LENGTH	CODE NUMBER	SUGG. RETAIL	*TOTAL CAPACITY	**AVG. WEIGHT	OVERALL LENGTH	SIGHT RADIUS	***DROP AT COMB	DROP AT HEEL	LENGTH OF PULL	RATE OF TWIST
BUCK MARK FULL LINE DEALER TARGET GRAY LAMINATE RIFLE												
	22 L.R.	18"	021030202	\$679.00	11	5 lbs. 8 oz.	33 ⁵ / ₈ "	—	7 ⁷ / ₈ "	1 ¹ / ₂ "	15 ¹ / ₈ "	1 in 16"
BUCK MARK TARGET RIFLE												
	22 L.R.	18"	021025202	\$659.00	11	5 lbs. 6 oz.	33 ⁵ / ₈ "	—	7 ⁷ / ₈ "	1 ¹ / ₂ "	15 ¹ / ₈ "	1 in 16"
BUCK MARK SPORTER RIFLE												
	22 L.R.	18"	021026102	\$659.00	11	4 lbs. 6 oz.	33 ⁵ / ₈ "	12 ³ / ₈ "	7 ⁷ / ₈ "	1 ¹ / ₂ "	15 ¹ / ₈ "	1 in 16"

NOTE: *Total capacity includes one round in the chamber. **Weights listed are approximate. ***Measured from centerline of bore.

ACTION

The straight blowback design offers enhanced simplicity and reliability.

SLIDE

Built-in recess and raised side panels for improved cocking grip. The convenient manual slide release is easily operated with your shooting or support hand.

BARREL

Most models have bull barrels for improved stability. The Challenge model has a tapered barrel, while the Lite model has a steel liner inside an ultralight aluminum sleeve. Each chamber is hand-reamed and muzzle crowns are recessed to protect them from damage that could degrade accuracy.

REAR SIGHT

16-click per revolution adjustable Pro-Target™ sight is standard on all models. This sight provides a finer range of adjustment over the industry's standard of 12-clicks per revolution.

FRONT SIGHT

Plus models feature a TRUGLO®/Marble's® fiber-optic front sight. The 5.5 Target includes hooded target sights.

FRAME

While many popular 22 pistols are cast or fabricated from sheet metal stampings, each Buck Mark frame is CNC machined from 7075-T6 aluminum to exacting tolerances.

MAGAZINE

The magazine body is heat treated for long-term feeding reliability. Coil spring provides more consistent follower angle. 10-round capacity.

MAGAZINE RELEASE

Positioned adjacent to the trigger guard for convenient operation.

TRIGGER

Compare it to the competition and feel its light, crisp break with less creep and overtravel.

SAFETY

Large, manual thumb safety. The trigger is disconnected when the magazine is removed for added safety.

GRIPS

Several wood, laminate and composite styles are available. Soft nitrile rubber Ultragrip RX® (URX) and wood Ultragrip Deluxe® (UDX) ambidextrous grips have ergonomic finger grooves for enhanced control.

BUCK MARK® PISTOLS. BUILT TO HIGHER STANDARDS FOR EXCEPTIONAL ACCURACY.

Still made in the USA, the Browning Buck Mark sets the bar high for rimfire handguns with a machined aluminum frame, precision barrel, smooth trigger and fully adjustable sights. Quality, accuracy and long-term dependability are all features you will come to appreciate from a Buck Mark.

BUCK MARK PISTOL



The straight blowback design and hand-reamed chamber of the Buck Mark contribute to its legendary reliability and accuracy.



Ultragrip RX® adds control and comfort.



Pro-Target rear sight offers finer adjustment clicks for greater accuracy.

EXTRA MAGAZINES

CALIBER	CODE NUMBER	SUGG. RETAIL
EXTRA BUCK MARK MAGAZINES		
22 L.R.	112055190	\$29.99

All Browning firearms are shipped with a free locking device to assist in the safe storage of firearms.

BUCK MARK LITE GREEN/GRAY

NEW



Green 7.25



Gray 5.5

RECEIVER - Alloy · Matte green or gray finish
 BARREL - Alloy sleeved · Matte green or gray finish
 · Fluted · Available in 5½" and 7¼" lengths
 ACTION - Blowback · Single-action trigger
 GRIPS - Ultragrip RX® ambidextrous
 FEATURES - Pro-Target™ adjustable rear sight
 · TRUGLO®/Marble's® fiber-optic front sight

BUCK MARK PRACTICAL URX

NEW



RECEIVER - Alloy · Matte gray finish
 BARREL - Tapered bull 5½" · Matte blued finish
 ACTION - Blowback · Single-action trigger
 GRIPS - Ultragrip RX® ambidextrous
 FEATURES - Pro-Target™ adjustable rear sight
 · TRUGLO®/Marble's® fiber-optic front sight



MODEL	FINISH	GRIPS	BARREL LENGTH	CODE NUMBER	SUGG. RETAIL	*AVG. WEIGHT	OVERALL LENGTH	SIGHT RADIUS
NEW Lite Green 5.5	Matte Green	URX Ambidextrous	5½"	051459490	\$519.00	28 oz.	9½"	8"
NEW Lite Green 7.25	Matte Green	URX Ambidextrous	7½"	051460490	539.00	30 oz.	11½"	9½"
NEW Lite Gray 5.5	Matte Gray	URX Ambidextrous	5½"	051461490	519.00	28 oz.	9½"	8"
NEW Lite Gray 7.25	Matte Gray	URX Ambidextrous	7½"	051462490	539.00	30 oz.	11½"	9½"
NEW Practical URX	Matte Gray	URX Ambidextrous	5½"	051448490	399.00	34 oz.	9½"	8"

NOTE: *Weights listed are approximate.

BUCK MARK PLUS UDX

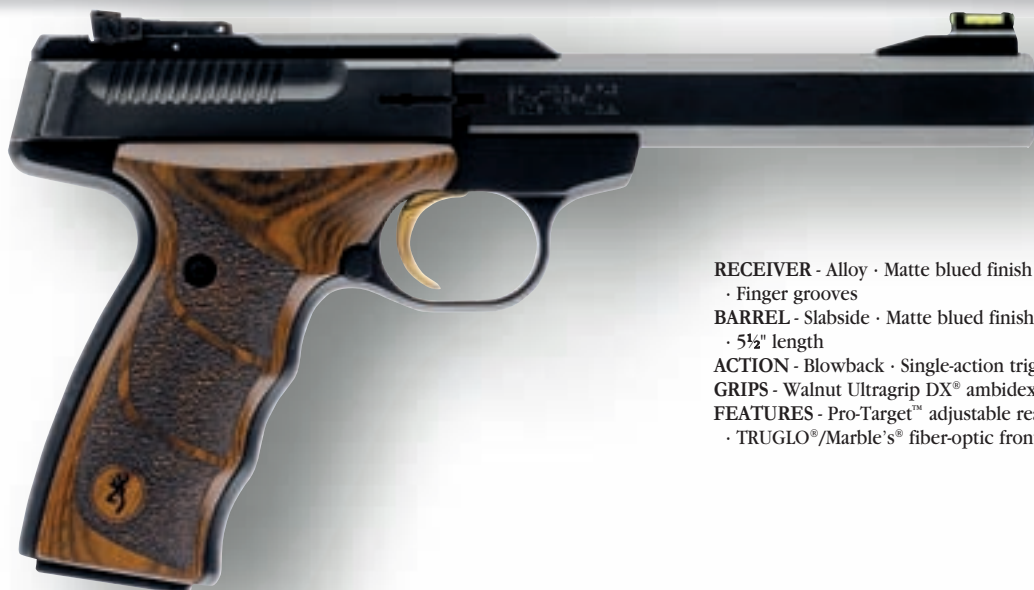

RECEIVER - Alloy · Matte blued finish
 · Finger grooves
 BARREL - Slabside · Matte blued finish
 · 5½" length
 ACTION - Blowback · Single-action trigger
 GRIPS - Walnut Ultragrip DX® ambidextrous
 FEATURES - Pro-Target™ adjustable rear sight
 · TRUGLO®/Marble's® fiber-optic front sight

BUCK MARK PLUS STAINLESS UDX



RECEIVER - Alloy · Matte blued finish · Finger grooves
 BARREL - Stainless slabside · Matte finish · 5½" length
 ACTION - Blowback · Single-action trigger
 GRIPS - Black laminated Ultragrip DX® ambidextrous
 FEATURES - Pro-Target™ adjustable rear sight
 · TRUGLO®/Marble's® fiber-optic front sight

BUCK MARK PLUS ROSEWOOD UDX



RECEIVER - Alloy · Matte blued finish · Finger grooves
 BARREL - Slabside · Matte blued finish · 5½" length
 ACTION - Blowback · Single-action trigger
 GRIPS - Rosewood Ultragrip DX® ambidextrous
 FEATURES - Pro-Target™ adjustable rear sight
 · TRUGLO®/Marble's® fiber-optic front sight
 · Available only from Browning Full Line and Medallion Dealers

BUCK MARK CAMPER STAINLESS URX



RECEIVER - Alloy · Matte blued finish
 BARREL - Stainless tapered bull 5½" · Matte finish
 ACTION - Blowback · Single-action trigger
 GRIPS - Ultragrip RX® ambidextrous
 FEATURES - Pro-Target™ adjustable rear sight
 · TRUGLO®/Marble's® fiber-optic front sight
 · Available only from Browning Full Line and Medallion Dealers



MODEL	FINISH	GRIPS	BARREL LENGTH	CODE NUMBER	SUGG. RETAIL	*AVG. WEIGHT	OVERALL LENGTH	SIGHT RADIUS
Plus UDX	Matte Blued	Brown Laminate UDX, Ambidextrous	5½"	051428490	\$499.00	34 oz.	9½"	8"
Plus Stainless UDX	Matte Stainless Slide & Barrel	Black Laminate UDX, Ambidextrous	5½"	051427490	539.00	34 oz.	9½"	8"
FLD Plus Rosewood UDX	Matte Blued	Rosewood UDX, Ambidextrous	5½"	051429490	499.00	34 oz.	9½"	8"
FLD Camper Stainless URX	Matte Stainless Slide & Barrel	Molded Comp., Ambidextrous	5½"	051442490	399.00	34 oz.	9½"	8"

NOTE: *Weights listed are approximate.



BUCK MARK CAMPER



RECEIVER - Alloy · Matte blued finish
 BARREL - Tapered bull 5½" · Matte blued finish
 ACTION - Blowback · Single-action trigger
 GRIPS - Black composite
 FEATURES - Pro-Target™ adjustable sights

BUCK MARK STANDARD URX



RECEIVER - Alloy · Matte blued finish
 BARREL - Slabside · Matte blued finish with polished flats · Available in Standard 5½" and Micro 4"
 ACTION - Blowback · Single-action trigger
 GRIPS - Ultragrip RX® ambidextrous
 FEATURES - Pro-Target™ adjustable sights

BUCK MARK CAMPER STAINLESS



RECEIVER - Alloy · Matte blued finish
 BARREL - Stainless tapered bull 5½" · Matte finish
 ACTION - Blowback · Single-action trigger
 GRIPS - Black composite
 FEATURES - Pro-Target™ adjustable sights

BUCK MARK STANDARD STAINLESS URX



RECEIVER - Alloy · Matte blued finish
 BARREL - Stainless slabside 5½"
 ACTION - Blowback · Single-action trigger
 GRIPS - Ultragrip RX® ambidextrous
 FEATURES - Pro-Target™ adjustable sights

MODEL	FINISH	GRIPS	BARREL LENGTH	CODE NUMBER	SUGG. RETAIL	*AVG. WEIGHT	OVERALL LENGTH	SIGHT RADIUS
Camper	Matte Blued	Molded Comp., Ambidextrous	5½"	051379490	\$349.00	34 oz.	9½"	8"
Camper Stainless	Matte Stainless Slide & Barrel	Molded Comp., Ambidextrous	5½"	051381490	389.00	34 oz.	9½"	8"
Standard URX (shown)	Matte Blued	URX Ambidextrous	5½"	051407490	429.00	34 oz.	9½"	8"
Micro Standard URX	Matte Blued	URX Ambidextrous	4"	051408490	429.00	32 oz.	8"	6¼"
Standard Stainless URX	Matte Stainless	URX Ambidextrous	5½"	051409490	469.00	34 oz.	9½"	8"

NOTE: *Weights listed are approximate.

BUCK MARK HUNTER



RECEIVER - Alloy · Matte blued finish
 BARREL - Heavy tapered round bull 7¼"
 · Matte blued finish · Integral scope base
 ACTION - Blowback · Single-action trigger
 GRIPS - Laminated cocobolo target
 FEATURES - Pro-Target™ adjustable rear sight
 · TRUGLO®/Marble's® fiber-optic front sight
 · Electronic sight and rings not included

BUCK MARK 5.5 FIELD



RECEIVER - Alloy · Matte blued finish
 BARREL - Heavy round bull 5½"
 · Matte blued finish · Full-length scope base
 ACTION - Blowback · Single-action trigger
 GRIPS - Laminated cocobolo target
 FEATURES - Pro-Target™ adjustable sights



BUCK MARK CONTOUR URX



RECEIVER - Alloy · Matte blued finish
 BARREL - Special contour · Matte blued finish · Full-length scope base · Available in 5½" and 7¼"
 ACTION - Blowback · Single-action trigger
 GRIPS - Ultragrip RX® ambidextrous
 FEATURES - Pro-Target™ adjustable sights

Special barrel profile on Contour Model.

BUCK MARK BULLSEYE URX



RECEIVER - Alloy · Matte blued finish
 BARREL - Heavy round fluted bull 7¼"
 · Matte blued finish
 ACTION - Blowback · Single-action trigger
 GRIPS - Ultragrip RX® ambidextrous
 FEATURES - Pro-Target™ adjustable sights

BUCK MARK BULLSEYE TARGET STAINLESS



RECEIVER - Alloy · Matte blued finish
 BARREL - Stainless heavy round fluted bull 7¼" · Matte finish
 ACTION - Blowback · Single-action trigger
 GRIPS - Laminated rosewood
 FEATURES - Pro-Target™ adjustable sights

MODEL	FINISH	GRIPS	BARREL LENGTH	CODE NUMBER	SUGG. RETAIL	*AVG. WEIGHT	OVERALL LENGTH	SIGHT RADIUS
Hunter	Matte Blued	Cocobolo, Ambidextrous	7¼"	051403490	\$459.00	38 oz.	11⅞"	9⅞"
Contour 5.5 URX (shown)	Matte Blued, Polished Barrel Flats	URX Ambidextrous	5½"	051421490	499.00	36 oz.	9½"	8"
Contour 7.25 URX	Matte Blued, Polished Barrel Flats	URX Ambidextrous	7¼"	051422490	509.00	39 oz.	11⅞"	9⅞"
5.5 Field	Matte Blued	Cocobolo, Ambidextrous	5½"	051401490	619.00	35½ oz.	9½"	8"
Bullseye URX	Matte Blued	URX Ambidextrous	7¼"	051411490	579.00	39 oz.	11⅞"	9⅞"
Bullseye Target Stnls.	Matte Stainless Slide & Barrel	Laminated Rosewood	7¼"	051426490	759.00	39 oz.	11⅞"	9⅞"

NOTE: *Weights listed are approximate.

75
Years
 1935 - 2010
OF THE BROWNING HI POWER



Shown: Hi Power Standard

See page 77 for Anniversary Edition specifications.

SPECIAL ENGRAVING

To commemorate this historic event for 2010 all Hi Power pistols will be adorned with this special engraving on the top of the slide.



NEW

THE 75TH ANNIVERSARY OF A LEGEND.

In 1923 the French Ministry of War called upon Fabrique Nationale® of Belgium to provide a high-capacity 9mm handgun for military trials. Within months, John M. Browning answered the call with two pistols, the last handguns he designed before his death in 1926. One pistol, designated the Model 1922, was entered and performed admirably at the trials. Though not chosen, it would undergo continuous refinement for the next 14 years by FN's chief firearms technician, the legendary Dieudonne J. Saive. The culmination of the combined efforts of two of the greatest minds the firearms industry has ever known resulted in the FN Model 1935, better known as the Browning Hi Power, one of the greatest firearms ever produced. This legendary sidearm has performed admirably in the hands of military, law enforcement and sport shooters worldwide, and continues to be revered as one of the finest handguns ever produced. 2010 represents the 75th anniversary of the Hi Power. Now is the time to own a legend.

HI POWER™. 75 YEARS OF BEING THE BEST THERE IS.

The solid heft of steel and wood in your hand is not easily replicated with today's polymer pistols, and it's one of the reasons the Hi Power is still so sought after. Its magazine capacity, durability, accuracy and perfect ergonomics have made the Hi Power the sidearm of choice for military, law enforcement and civilians worldwide for seventy-five years.

HI POWER PISTOL

All Browning firearms are shipped with a free locking device to assist in the safe storage of firearms.



SAFETY

A large, ambidextrous manual thumb safety is conveniently located on the frame just above the grip.



SIGHTS

Hi Power pistols are available with fixed, low-profile three-dot sights. The Hi Power Standard is also available with optional low-profile target sights that are adjustable for windage and elevation.



MAGAZINE CAPACITY

Double-stack magazine design. A 13-round magazine is standard in 9mm, and a 10-round magazine is standard in 40 S&W. 10-round models in 9mm are available where required by law. Follow state and local laws regarding magazine capacity when ordering.

TRIGGER

The light single-action trigger breaks clean and crisp. This is the system preferred by professionals around the world.



FRAME AND SLIDE

The frame and slide are built from solid steel, yet remain lightweight. The heft of the Hi Power keeps recoil light and manageable for accurate firing, even at a rapid rate. The Hi Power's balance in your hand is impeccable.

HI POWER MARK III (FIXED SIGHTS)



RECEIVER - Steel · Black epoxy finish
BARREL - 4 $\frac{5}{8}$ " · Black epoxy on slide
 · Low profile fixed sights
ACTION - Locked breech · Single-action trigger
 · Ambidextrous thumb safety
GRIPS - Composite panels · Thumb rest
FEATURES - Extra magazine

HI POWER STANDARD (FIXED OR ADJUSTABLE SIGHTS)



RECEIVER - Steel · Polished blued finish
BARREL - 4 $\frac{5}{8}$ " · Polished blued finish on slide · Low profile fixed or adjustable rear sights with ramped front post
ACTION - Locked breech · Single-action trigger · Ambidextrous thumb safety
GRIPS - Select walnut · Cut checkering
FEATURES - Extra magazine

MODEL	FINISH	GRIPS	BARREL LENGTH	10 CAPACITY CODE	13 CAPACITY CODE	SUGG. RETAIL	*AVG. WEIGHT	OVERALL LENGTH	SIGHT RADIUS
HI POWER MARK III, FIXED SIGHTS									
9mm	Black Epoxy	Molded Composite	4 $\frac{5}{8}$ "	051001393	051002393	\$999.00	32 oz.	7 $\frac{3}{4}$ "	6 $\frac{5}{16}$ "
40 S&W	Black Epoxy	Molded Composite	4 $\frac{5}{8}$ "	051001394	—	999.00	35 oz.	7 $\frac{3}{4}$ "	6 $\frac{5}{16}$ "
NEW HI POWER MARK III 75TH ANNIVERSARY EDITION, FIXED SIGHTS									
9mm	Black Epoxy	Molded Composite	4 $\frac{5}{8}$ "	051036393	051037393	\$999.00	32 oz.	7 $\frac{3}{4}$ "	6 $\frac{5}{16}$ "
HI POWER STANDARD, FIXED SIGHTS									
9mm	Blued	Walnut	4 $\frac{5}{8}$ "	051003393	051004393	\$1,029.00	32 oz.	7 $\frac{3}{4}$ "	6 $\frac{5}{16}$ "
40 S&W	Blued	Walnut	4 $\frac{5}{8}$ "	051003394	—	1,029.00	35 oz.	7 $\frac{3}{4}$ "	6 $\frac{5}{16}$ "
NEW HI POWER STANDARD 75TH ANNIVERSARY EDITION, FIXED SIGHTS									
9mm	Blued	Walnut	4 $\frac{5}{8}$ "	051034393	051035393	\$1,029.00	32 oz.	7 $\frac{3}{4}$ "	6 $\frac{5}{16}$ "
HI POWER STANDARD, ADJUSTABLE SIGHTS									
9mm	Blued	Walnut	4 $\frac{5}{8}$ "	051003493	051004493	\$1,099.00	32 oz.	7 $\frac{3}{4}$ "	6 $\frac{1}{2}$ "
40 S&W	Blued	Walnut	4 $\frac{5}{8}$ "	051003494	—	1,099.00	35 oz.	7 $\frac{3}{4}$ "	6 $\frac{1}{2}$ "
NEW HI POWER STANDARD 75TH ANNIVERSARY EDITION, ADJUSTABLE SIGHTS									
9mm	Blued	Walnut	4 $\frac{5}{8}$ "	051032493	051033493	\$1,099.00	32 oz.	7 $\frac{3}{4}$ "	6 $\frac{1}{2}$ "

NOTE: *Weights listed are approximate.

EXTRA MAGAZINES

CALIBER	CODE NUMBER	SUGG. RETAIL	CALIBER	CODE NUMBER	SUGG. RETAIL
EXTRA HI POWER PISTOL MAGAZINES (10-SHOT CAPACITY)			EXTRA HI POWER MAGAZINES (13-SHOT CAPACITY)		
9mm, S.A., H.P., Standard	112050193	\$59.99	9mm, S.A., H.P., Standard	112050293	\$69.99
9mm, S.A., H.P., Pachmayr®	112051193	59.99	9mm, S.A., H.P., Pachmayr®	112051293	69.99
40 S&W, S.A., H.P., Standard	112050194	59.99			
40 S&W, S.A., H.P., Pachmayr®	112051194	59.99			

CUSTOM SHOP

A CUSTOM BROWNING. A LIVING PIECE OF BROWNING HISTORY.

John M. Browning's legacy as the world's greatest firearms inventor lives on in hand-crafted firearms from the Browning Custom Shop in Belgium. Hand assembled and embellished to your discriminating tastes, a custom Browning utilizes time proven designs such as the legendary Superposed, BAR® and Hi Power,™ and traditional hands-on manufacturing methods to ensure your investment in custom work, and the memories made with it, will be enjoyed and shared for generations. For information, call (801) 876-2711 or visit browning.com/custom and download the Custom Shop brochure to see all of the options available.

B25 SUPERPOSED

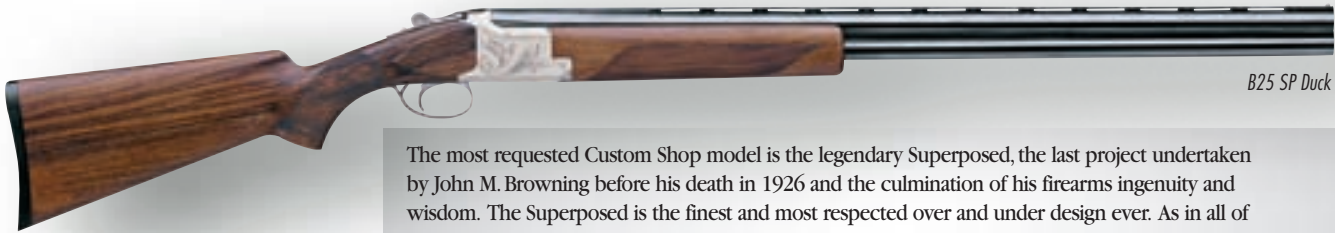

B25 SP Duck

The most requested Custom Shop model is the legendary Superposed, the last project undertaken by John M. Browning before his death in 1926 and the culmination of his firearms ingenuity and wisdom. The Superposed is the finest and most respected over and under design ever. As in all of Browning's work, the Superposed delivers with perfect balance, economy of proportion and eye-appealing design. As beautiful as a custom Superposed is, it begs to be carried in the field, just as Mr. Browning intended.



Left side engraving details



B25 GRADE C11



B25 GRADE B2G



B25 EVOLUTION



DIANA™



B25 GRADE D11



B25 GRADE C12



B25 GRADE C2G



MIDAS™



B25 GOLD



B25 GRADE D12



B25 GRADE D5G



PIGEON



B25 SPECIAL DUCK



B25 SPECIAL WOODCOCK



B25 GRADE I1



B25 GRADE E1



B25 GRADE F1



B25 GRADE M1



B25 GRADE M2

EXPRESS RIFLES



CCS 25 Pursuite

A solid action frame with a reinforced lock, thickened barrels and a pistol grip stock make these Browning Express rifles the perfect firearm for big game hunting and African safaris. Available in 270 Win., 30-06 Sprg., 30R Blaser, 7x65R, 8x57JRS, 9.2x62 or 9.3x74R calibers.



CCS 25 Grade B2E (Left)

CCS 25 Grade Bavarian (Left)

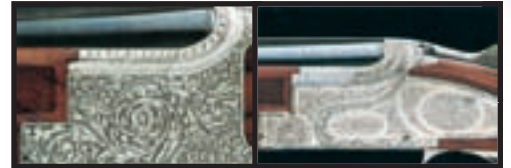

CCS 25 Grade D5G (Left)

CCS 25 Grade M1 (Left)

BAR



These fine BAR rifles feature detailed hand engraving and expert assembly at the Custom Shop. Please contact the Custom Shop for a complete list of engraving options. It is available in 243 Win., 25-06 Rem., 30-06 Sprg., 270 Win., 308 Win., 300 Win. Mag., 7mm Rem. Mag. or 338 Win. Mag. calibers.



SEMI-AUTO 22 LUXE



SA-22 GRADE III

SA-22 GRADE II (RIGHT)

SA-22 GRADE III (RIGHT)

The most widely sold and most imitated .22 autoloader. This rimfire is particularly light and efficient. The barrel and receiver can be separated in an instant. It is available in numerous versions, including the deluxe models, which continue to be made in the Custom Shop.

HI POWER LUXUS



GP GRADE II

GP RENAISSANCE ARGENT

GP GRADE B2

GP RENAISSANCE OR

The Browning Hi Power is one of the greatest pistol designs of all time. A custom Hi Power offers all the engineering genius of John M. Browning embellished with the beauty and craftsmanship provided by the Browning Custom Shop. A Hi Power Luxus pistol must be held to be fully appreciated.

CUSTOM MADE IN BELGIUM

The Custom Gun Shop of Fabrique Nationale and the Herstal, Belgium Engravers' Cooperative, will make available on special order many different custom enhancements.



These firearms will be fully assembled, fitted and engraved in Belgium to your personal designs and specifications.

PRICE

Prices for the basic firearm, before custom enhancement, are available from the sales department at Browning in Morgan, Utah by calling (801) 876-2711. All prices are subject to change due to changing world currencies.

BROWNING

BROWNING.COM/CUSTOM



HOW TO ORDER

All inquiries for Custom Gun Shop products will be submitted to headquarters in Morgan, Utah. Once the basic specifications have been determined, a written order should be placed with the Morgan office. The specifications will be reviewed with the Custom Shop in Belgium, and a price and delivery date will be determined.

HOW TO BUILD A CUSTOM GUN

Visit browning.com/custom to view or download the Browning Custom Shop brochure. In addition to showcasing the firearms available, this brochure displays and explains the many grades, engraving patterns, checkering patterns, stock and forearm designs and personal touches available to the customer.

DELIVERY

Actual production time will be based on the complexity and detail of the custom order. An approximate delivery date will be furnished with the factory cost quotation.

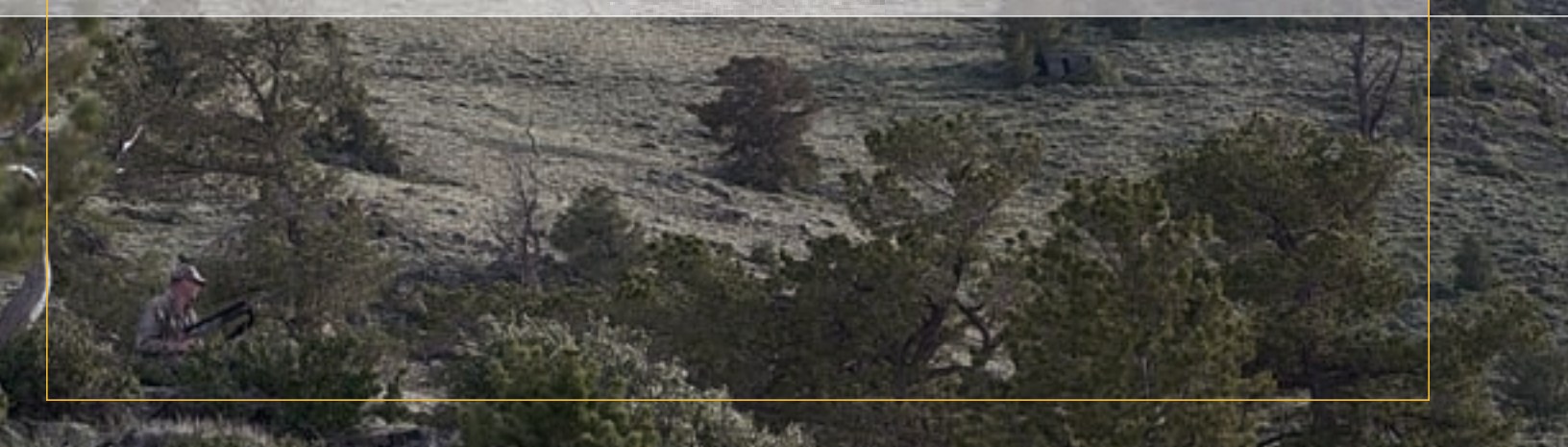

SAFES



SAFES INDEX

ACCESSORY/OPTION INFORMATION

Factory-Installed Accessories	105
Game Scenes	102
Heritage Graphics	101
Lock Options	106
User-Installed Accessories	104

FEATURE INFORMATION

Competitive Comparison	85
Feature Guide	82
Pry and Fire-Resistance	84
Storage Solutions/Interiors	86-87
Understanding Safe Features	83

SAFES: PREMIUM

Gold Series	90-91
Medallion Series	92-93
Platinum Plus Series	88-89
Silver Series	94-95

SAFES: VALUE

Bronze Series	96
TheftGard	97

SAFES: SPECIALTY

Compact Series	102
Heritage Graphics	101
Security Door	103
Select Series	100
Tactical Series	98-99
Universal Vault Door	103

SUPPORTING INFORMATION

Warranty	106
----------	-----

Browning ProSteel Safes are the most innovative, best constructed gun safes in the industry. We constantly strive to make improvements to security, fire protection, storage and convenience to keep them ahead of the competition. You can be confident that your Browning ProSteel Safe will give you the latest and most important features available.

For 2010, we have added an array of anti-pry features for additional protection against this type of attack. Our innovative Pry-Stop Corner Bolts and Pry-Stop End Bolts make it extremely difficult to break into a Browning ProSteel Safe by prying. We have also improved convenience in most safes with the addition of the new Quick Access DPX® door rack that makes it even easier to get long guns in and

out of safes, and DPX Handgun Pouches that allow you to store more handguns than ever before without taking up valuable shelf space.

Whatever level of protection you need, there is a Browning ProSteel Safe that will fit your needs and budget, each with the added security, fire protection and storage extras offered only by The Best There Is® in the safe industry.



Pry-Stop Corner Bolts

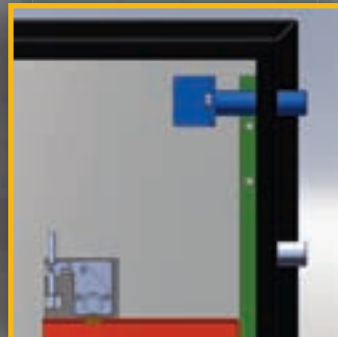

Pry-Stop End Bolt Mechanism



Quick Access DPX Barrel Racks



DPX Handgun Pouch

SAFE FEATURE ICONS

The icons below highlight key features of Browning ProSteel Safes, and help you quickly identify and compare the features of different safe models.



FIRE/SECURITY RATINGS

Fire and Security thermometers make it easier to compare the level of protection Browning ProSteel Safes provide in these two important areas. The "F" indicates fire protection and the "S" indicates security level. Higher numbers mean better protection.

	<p>FORCE DEFLECTOR™ LOCKING SYSTEM – The Force Deflector Locking System (patent pending) prevents bolt or handle forces from reaching the lock by using a rotating cam device. It prevents energy transfer to the lock better than most systems used in the safe industry.</p>		<p>PRY-STOP CORNER BOLTS – Pry-Stop Corner Bolts provide better protection than other pry-defense designs. Innovative long locking bolts extend diagonally from a reinforced support at the corners of the door to protect against pry attack at the vulnerable corner areas.</p>
	<p>UNI-FORCE™ LOCKING SYSTEM – Our finest safe locking mechanism uses robust cam locks and a large, multiple diversion bar system to prevent bolt or handle pressure from reaching the lock. Forces go to the cams and diversion bars, not the lock, for protection unmatched by other locking systems.</p>		<p>PRY-STOP END BOLTS – Superior to other bolt designs which allow the locking bolt support bar to bend. Pry-Stop End Bolts are over 2½ times longer and attach to a high-strength steel angle iron which prevents the locking bolt support bar from bending in a pry attack. The top and bottom locking bolts on the door side secure the critical door corners.</p>
	<p>1" FORMED DOOR – The 1" Formed Door is engineered with a rugged steel face, back and reinforcement panels to provide excellent strength and attack protection compared to the competition.</p>		<p>LOCKING BOLTS (VARIABLE SIZE) – The rugged steel pieces that move behind the door frame to actually hold the safe door locked and closed. Bigger bolts, and more of them, provide greater security.</p>
	<p>DUO-FORMED® DOOR – The best safe door we offer is formed from multiple layers of steel, carefully formed together to provide superior strength, pry-resistance and attack protection. Full second panel for outstanding strength. The door face is 1½" thick.</p>		<p>BOLT DIRECTION – Better safes have locking bolts extending from all four sides of the door for extra resistance to pry attack. Safes with bolts on three sides have them on both sides of the door and on the top edge.</p>
	<p>OMNIBARRIER® LOCK PROTECTION SYSTEM – A carefully engineered structure of steel hard plate and steel components designed to protect the safe lock from drill, punch and push attacks.</p>		<p>BODY THICKNESS (VARIABLE MEASURE) – The thickness of the steel that comprises the safe body. A smaller gauge number means thicker steel, which provides more security than thinner steel. The thickest Browning ProSteel Safe body is ¾" (on Platinum Plus) and this specification is not shown in gauge measurement.</p>
	<p>FIRE RATING (VARIABLE TIME) – A laboratory measurement of time and temperature (in Fahrenheit) used to compare the relative amount of fire-resistance provided by a safe. Safes with a longer fire rating time provides more fire protection than a safe with a shorter time.</p>		<p>DRILL-RESISTANT DEFLECTOR PLATE – A hardened steel plate strategically positioned at an angle in the door which causes drill bits to bend or break, providing additional protection for the lock.</p>
	<p>LAYERS OF INSULATION – The most important factor in fire protection is the total thickness of the insulation in the safe. More insulation means more protection from fire. Our safes use ½" thick gypsum panels, so the number of layers multiplied by ½" shows the total insulation thickness in inches.</p>		<p>LIGHT PACKAGE / MIRROR – The interior light package includes two light modules to illuminate the safe interior. A mirror covers the top half of the rear wall of the safe. Combined, they make it easier for you to find items inside the safe.</p>
	<p>REINFORCED DOOR FRAME – The door opening of the safe is strengthened by a U-shaped steel channel around the entire perimeter to create added pry and attack resistance.</p>		<p>DPX® SYSTEM – The patented Duo-Plus Extra Storage System is our most versatile our safe interior. It includes a rack to store long guns on the door back. There is also a variety of pouches and pockets to store other valuables on the door back. See page 87 for a complete description.</p>
	<p>180° HEAVY DUTY HINGES – Rugged hinges are machined from solid steel bar stock for strength. The hinges allow the door to swing open 180° for unhindered access to the safe interior. Hinge-side locking bolts maintain full security even if the hinges are cut off. The door is removable to simplify moving of the safe.</p>		<p>DUO-PLUS™ – This patent-pending safe interior increases long gun capacity and makes access to long guns easier with an innovative door-mounted rack.</p>
	<p>UL® SECURITY CONTAINER RATING – The industry standard test and rating for home/personal safes. Requires minimum construction specifications and passing a laboratory attack test. Our premium safes far exceed the minimum requirements for the UL Residential Security (Tool Attack) listing.</p>	<h2>WHY STEP UP?</h2> <p>Starting with the flagship Platinum Plus Series, there is a "Why Step Up?" section at the top of the description area for each series. This section is a list of just the features that distinguish that series from the series below (to the next page or pages) in the safe line up. "Why Step Up?" is an easy comparison between Browning ProSteel Safe series.</p>	

WHAT YOU SHOULD KNOW BEFORE BUYING A GUN SAFE.

Not all gun safes are the same. Different safes offer more or less protection, depending on the features included in the safe. This quick guide helps explain different feature areas and the comparative

protection offered by individual features. You can determine the level of protection you want and need, and choose a safe that best meets those needs.

SECURITY

LOCKING SYSTEM

The locking system connects the lock with the handle and the locking bolts. Better systems are engineered to protect against differing types of criminal attack.

BEST – Uni-Force™ System — Ultimate protection against pry and side bolt attacks. Includes the OmniBarrier® System to encase the lock in steel and hard plate, protecting it against drill and punch attack.

BETTER – Force Deflector™ System — Better than most industry systems protecting against side bolt attack. Includes a secondary re-locker, hard plate and hardened pin lock protection to defend against attacks on the lock.

GOOD – Standard Locking System — Does not provide protection against side bolt attack. All Browning ProSteel Safes feature either the Uni-Force or Force Deflector Systems to defend against side bolt attack.

DOOR THICKNESS

A thicker, more rigid door is better able to resist pry attacks. A door formed from multiple pieces of steel is more rigid because strategic bends in the metal add strength. A formed door also includes fire insulation, and therefore provides more fire protection.

BEST – Duo-Formed® Door — 1 $\frac{1}{8}$ " thick door face. Full steel interior panel.

BETTER – 1" Formed Door — 1" thick door face. Steel reinforcement panels.

GOOD – Plate Door — $\frac{3}{8}$ " thick solid steel door face. All Browning ProSteel Safes have a Best or Better type door.

STEEL THICKNESS

Thicker steel means more protection from any type of criminal attack and from fire.

BEST – $\frac{3}{8}$ " Steel — Equivalent to about 6.5 gauge, 0.1875" thick.

BETTER – 10 gauge or 11 gauge — 0.135" or 0.12" thick.

GOOD – 12 gauge — 0.105" thick.

LOCKING BOLT DESIGN, NUMBER AND PLACEMENT

Better designed locking bolt structures and bigger bolts provide more pry resistance. Top, bottom and corner placement also improve protection against prying.

BEST – Pry-Stop Corner Bolts, four-sided coverage — $\frac{1}{2}$ " or $\frac{1}{4}$ " bolts.

BETTER – Pry-Stop End Bolts, three- or four-sided coverage — $\frac{1}{4}$ " or 1" bolts.

GOOD – Standard Locking Bolts, two-sided coverage — 1" bolts.

FIRE PROTECTION

INSULATION THICKNESS

More insulation means more protection. Insulation acts as a barrier and has a cooling effect. Thicker insulation is a better barrier.

BEST – Five layers of $\frac{1}{2}$ " thick insulation — So thick it is very visible.

BETTER – Three or four layers of $\frac{1}{2}$ " insulation.

GOOD – One or two layers of $\frac{1}{2}$ " insulation.

DOOR SEAL

The door seal activates during a fire to seal the interior of the safe from the fire on the outside. It prevents heat from getting in around the perimeter of the door and keeps the inside cooler. Works by expanding intumescent action in response to heat.

BEST – Premium 3-in-1 Palusol® seal — Palusol is the industry standard expanding door seal. Includes triple-fin protection for a tighter seal and protection against cold smoke damage.

BETTER – Palusol® seal — Industry standard expanding door seal. Expands from five to nine times its original size.

GOOD – Simple rubber seal — All Browning ProSteel Safes use a Palusol® seal for better protection.

CONVENIENCE

INTERIOR CONFIGURATION

A safe should allow maximum storage within its interior, and make it easy for the owner to access the items stored inside.

BEST – DPX® Storage System — Store long guns, handguns and many small items on the door back in a system of pouches, pockets and loops. Long gun and shelf storage inside the safe, convertible to all long gun.

BETTER – Duo-Plus™ Interior — Store long guns on the door back. Long gun and shelf storage inside the safe, convertible to all long gun.

GOOD – Convertible long gun/shelf storage inside the safe — No long gun storage on the door back. All Browning ProSteel Safes designed for long gun storage have a Best or Better type interior.

OTHER IMPORTANT FEATURES

All Browning ProSteel Safes also include: 180° Opening External Hinges for easy access to safe interior (except Compact Series). A steel reinforced door frame for superior pry resistance. Industry-standard Sergeant & Greenleaf® mechanical or electronic locks. All Browning ProSteel Safes carry the UL® Residential Security Container rating.

SECURITY BUILT ON MANY LEVELS — INCLUDING ANTI-PRY.

When it comes to innovative security features, Browning ProSteel Safes are the industry leaders. For decades we have held a reputation for being particularly strong in resistance to side bolt, drill and punch

attacks. For 2010 extensive testing, scientific analysis and advanced engineering have produced even more features to defend against pry attacks better than ever before.

Four key design areas contribute to superior pry-resistance: (1) A rigid door, (2) a rigid safe body, (3) a stiff locking bolt assembly and (4) superior bolt engagement in the door frame. All four have been designed into Browning ProSteel Safes for better protection against pry attacks.

Safe corners are weak spots for a pry attack, and great efforts have gone toward addressing the corners to make them nearly impenetrable to pry attack. Our new Pry-Stop Corner Bolts (Platinum Plus, Gold and Medallion Series safes) and Pry-Stop End Bolts (Silver, Bronze, Select, Tactical) plus Anti-Pry Tabs and extension arms in the Uni-Force™ Locking System make corners and crucial moving parts more pry-resistant. Tight-tolerance door fit makes it more difficult to get a prying tool into the door gap, while thicker doors make it harder to get a pry tool behind the door. The number of safes with three and four side locking bolt coverage has grown for additional pry-resistance.

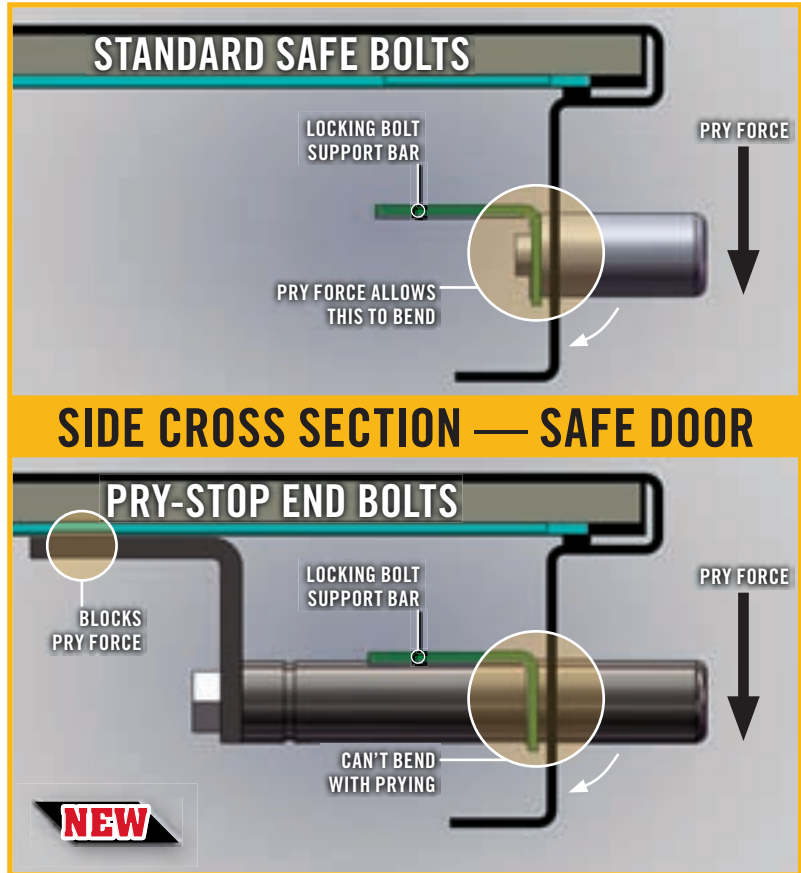

FIRE-RESISTANCE.

When comparing gun safe fire ratings, you will notice that they vary widely. That is because there is no industry standard for fire protection. Therefore, we follow a very stringent test specification — our own. We hold Browning ProSteel Safes to a higher standard for fire-resistance than much of the competition, and label our safes with a credible fire protection rating. After all, the Browning reputation is

on the line. The overall thickness of the insulation is the most important element in fire protection, and more insulation means better protection. Be confident that Browning ProSteel Safes offer excellent fire protection to protect your valuables in case of fire. Different ratings are useful for comparing fire protection in each Browning ProSteel safe series.

WHAT MAKES A SAFE FIRE-RESISTANT?

The amount of insulation, placement of insulation, steel thickness, fire seal and other design elements (rigid door, external hinges, formed door design) are all crucial factors.

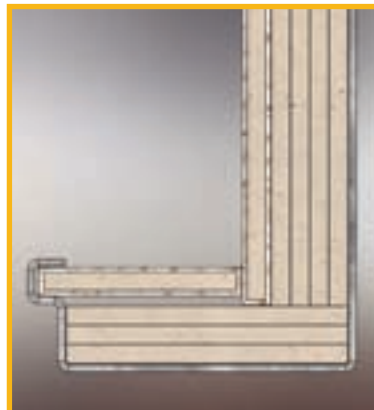

In a fire, the welds on a safe often pop due to safe body deformation from the extreme heat. The welds, along with other problems, allow heat to enter the safe and ultimately damage firearms and valuables beyond repair. Extensive testing, industry-leading engineering and decades of experience go into building Browning ProSteel Safes that provide excellent fire-resistance.

Since there is no industry standard test for fire-resistance, consumers are left to simply take the word of the company selling a gun safe. There isn't another safe company out there that has proven its trustworthiness by providing quality products for over 100 years. A Browning ProSteel safe backs up your trust with advanced fire protection features.

BROWNING PROSTEEL SAFES — TRUSTED SECURITY.

Browning is one of the most respected names in the firearms industry and symbolizes a tradition of high quality, innovative products. Those same values carry over into the Browning ProSteel line of safes. Browning safes not only look fantastic on the outside, the security and fire protection features inside of the safes are equally as impressive.

After all, looks add nothing to the real protection a safe provides. Only intelligent design and the highest quality construction will protect your belongings from fire damage and break in. In reality, a safe is a long-term investment in safety and protection. Make sure you invest in a Browning, The Best There Is®.

COMPETITIVE COMPARISON

When comparing a Browning ProSteel safe to the competition, it's clear to see that there really is no comparison. Here's why Browning is The Best There Is®:

BROWNING PROSTEEL SAFES

LESSER SAFES

1 ▶ STORAGE SYSTEM

The inside of Browning ProSteel Safes are outfitted with a Storage System to help you store more valuables, and get to them easier. Instead of just a simple gun rack and shelves, every model has a system designed to better utilize the space in the safe. The pockets, pouches and racks mounted on the back of the door provide amazing flexibility to store a variety of items.

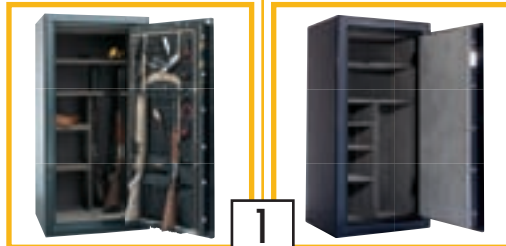

1

2 ▶ SAFE LOCKING MECHANISM

Uni-Force™ Locking System – Our premier locking mechanism (shown) uses robust cam locks and a large, multiple diversion bar system to prevent bolt or handle pressure from reaching the lock. Forces go to the cams and diversion bars, not the lock, creating protection unmatched by any other locking system.



2

3 ▶ DOOR CONSTRUCTION

For better security, the door must be designed and built to protect against multiple types of attack, and must engage the safe body in a manner that prevents break-in. Browning ProSteel safe doors provide extra protection in the areas most susceptible to attack and are more resistant to pry, drill and punch attacks.

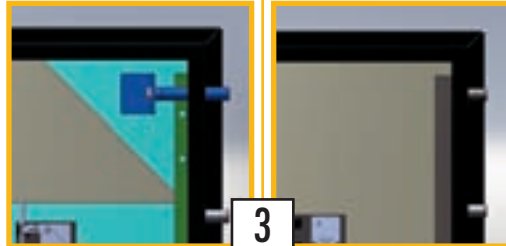

3

4 ▶ FIRE INSULATION / PALUSOL® FIRE SEAL

Browning ProSteel Safes have up to five layers of 1/2" insulation. Thickness of insulation is the most important factor in fire protection.

The Palusol seal used on Browning ProSteel fire-resistant safes extends around the door so it is completely sealed in case of a fire. When heated, the Palusol expands to seal the door frame.

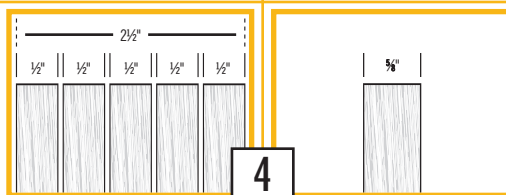

4

5 ▶ REINFORCED DOOR FRAME

Browning ProSteel Safes have an integrated reinforcement bent into the door frame of every model. The reinforcement is the actual steel thickness of the body with no welds for superior strength and makes the safes more pry-resistant.

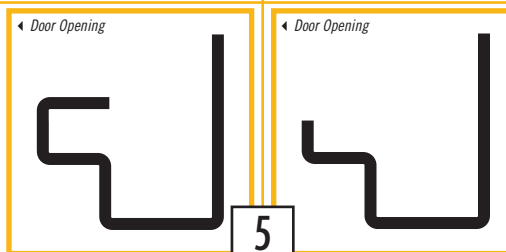

5

6 ▶ CONTINUOUS WELDS

Browning ProSteel Safes are constructed with continuous welds for optimal strength.

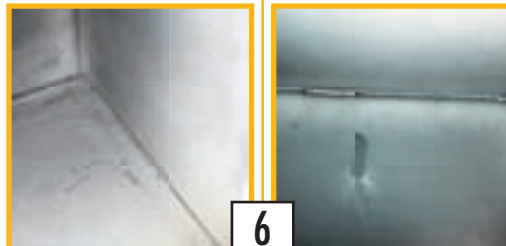

6

1 ▶ INTERIOR

Other safes simply come with an "interior" that doesn't maximize the storage capacity of the safe. The door back is wasted space. In some cases you must even assemble the shelves yourself. Interior hinges may only allow door to open part way.

2 ▶ SAFE LOCKING MECHANISM

A lesser locking mechanism allows force from the bolts or handle to reach the critical lock. The only protection for the lock is an after-the-fact relocking device.

3 ▶ DOOR CONSTRUCTION

Other safe doors may have weak points at the corners, and the locking bolts may be attached to a bar that is easily bent, both making the safe easier to pry open.

4 ▶ FIRE INSULATION / FIRE SEAL

Some manufacturers claim high temperature or long duration fire ratings with as little as 1/2" of insulation, and they may not want to tell you how much (or little) insulation is in the safe. Lesser safes have gaps in the insulation and the fire seal, and may use a lesser quality fire seal. Internal hinges may create large gaps in the insulation.

5 ▶ NON REINFORCED DOOR FRAME

Some safe manufacturers cut costs by not reinforcing the door frame. This fails to protect against prying or pounding, making the door itself a prime target for attack.

6 ▶ INTERMITTENT WELDS

Some lesser safes have intermittent welds, which create weak points in the safe body. Gaps in welds can also create the perfect pry point for a burglar. Gaps filled with auto body putty and painted over are weak, even if you can't see them.

STORAGE SOLUTIONS

Our versatile safe Storage Systems are designed to maximize not just gun and valuable storage in a safe, but allow you to store and organize odds and ends you never would have thought about keeping in a safe. Knives, GPS units and hunting and shooting gear can all find a home

in the pockets and pouches on the back of the door. More than just an “interior” like other safes, Browning safes have a comprehensive Storage System to help you store more valuables and allow easier access to all the safe’s contents.

DUO-PLUS™ STORAGE SYSTEMS

Many safe brands include a convertible interior, which allows the storage configuration inside the safe to be changed over time as your needs evolve. Browning ProSteel Safes introduced a concept that goes one step further: the Duo-Plus Interior (patent pending). The Duo Interior is Browning’s convertible interior, and the “Plus” is to utilize the inside of the safe door to easily and efficiently store more in the safe. Hence the “Duo-Plus” system includes a convertible interior shelving/rack arrangement, and innovative solutions to fully utilize the valuable space on the back of the door to hold more valuables.

The Duo-Plus concept is used in several different versions to create flexible and easy-access storage. The Duo-Plus Extra (DPX®) offers totally flexible storage of many types of items on the door back, while the Duo-Plus stores just long guns on the door back. No other safe company offers you as many versatile storage options on so many of their safe models.

CAPACITY COMPARISON — Up to 30% more than other safes

	Browning ProSteel 26 Cu. Ft. Model	Other Brand 25-28 Cu. Ft. Safe
Long Gun Capacity with Side Shelves in place	17 guns	11-14 guns
Fast Access Guns	9 guns	2 guns
Gun Locations	Interior and door back	Interior only

DPX STORAGE SYSTEM



QUICK ACCESS DPX® BARREL RACKS

The new Quick Access DPX Barrel Rack allows a long gun to be removed from the rack simply by pulling it straight out from the door back. Flexible polymer wings hold the barrel in place, yet bend to allow guns to easily be pushed into or pulled out of the rack. It’s standard on Platinum Plus, Gold and Medallion Series safes. With the standard DPX Barrel Racks long guns are slid out from under the barrel rack to remove them from the door back storage.

STORAGE SYSTEM DESCRIPTIONS

Each safe series has a standard interior/storage system. The specifications for each model include the type of interior and the long gun capacity for that particular model. Usable capacity depends on the types and configurations of guns stored.

The gun capacity description is a series of three numbers, for example 11/22+7. The first number is the long gun capacity of the interior portion of the safe with part of the space used for shelves (11 in the example). The second number is the interior long gun capacity if the shelves are removed (22 in the example). The "Plus" number (+7 in the

example) is the long gun capacity on the back of the door. The door back capacity can be used to store long guns whether or not shelves are used in the interior. With shelves in place, the safe in this example would have a total long gun capacity of 18 guns.

Different safe models in the same Series (Medallion for example) will have a different size interior of the standard configuration for that series. Photos below show a sample of each type of interior, but not each size. The actual interior size/capacity is shown in the specifications by model.



DPX® STORAGE SYSTEM

The patented (U.S. Patent # 7,409,790) Duo-Plus Extra (DPX) Storage System includes:

- Long gun storage on the door back
- A system of pouches and pockets to store small valuables on the door back
- DPX Handgun Pouches to store handguns on the door back or inside the safe
- A convertible Duo Interior system inside the safe with both shelves and long gun capacity

The DPX System is standard on the following safe series:

- Platinum® Plus
- Silver™
- Select™
- Gold®
- Bronze® (top half only)
- Tactical
- Medallion®



DUO-PLUS™ INTERIOR

The Duo-Plus Interior (patent pending) includes the following:

- A long gun rack mounted on the door
- A convertible Duo Interior system inside the safe with both shelves and long gun capacity
- The door back is finished in the same material as used inside the safe and the long gun rack is coated steel
- The Duo-Plus Interior is standard on TheftGard® safes

INTERIOR OPTIONS



ULTIMATE INTERIOR

ULTIMATE INTERIOR

The Ultimate Interior creates complete flexibility in the interior configuration. It can be factory-installed on Gold, Medallion or Silver Series safes. The Ultimate Interior adds extra shelves so that the entire interior portion of the safe can be used for small items on the shelves. The long gun rack from the DPX® remains on the door, so some long gun storage remains in the Ultimate Interior, even when the interior is all shelves.

The Ultimate Interior is available only as a factory-installed option on Gold, Medallion and Silver Series safes.

DPX® CAMO



DPX® MOSSY OAK® BREAK-UP® CAMO

If your favorite color is camo, then you will love the Mossy Oak Break-Up DPX Storage System. With a background of Break-Up and complementary color pouch and strap materials, the Camo DPX is an outdoor lover's dream. Available only to replace the DPX Storage System used standard on Platinum Plus, Gold, Medallion and Silver Series models. (Not available on Bronze, Tactical or Select.)

OPTIONAL INTERIORS	SUGG. RETAIL
Ultimate Interior (All eligible models)	\$65.00
DPX MOBU Camo	49.00

PLATINUM PLUS SERIES



PP47F | PLATINUM PLUS SERIES SAFE
COLOR SHOWN: BLACK CHERRY

THE HEIGHT OF PROTECTION AND QUALITY

WHY STEP UP TO A PLATINUM PLUS SERIES SAFE?

- Heavy 3/16" steel body
- 1200°/120 min. fire protection
- Grade VI interior package
- Integrated Jewelry Box

ANTI-PRY FEATURES

- Ultra-heavy 3/16" steel body
- Pry-Stop Corner Bolts at all four corners of the door
- 1½" chromed locking bolts, four-sided door coverage
- Extended throw locking bolts
- Uni-Force™ Locking System with Anti-Pry Tabs and extension arms
- Fully reinforced integrated door frame
- Tight-tolerance door fit
- 1¾" thick Duo-Formed® door

ADDITIONAL SECURITY FEATURES

- Uni-Force Locking System with three cams (four on PP56F and PP47F)
- OmniBarrier® Lock Protection System
- Drill-resistant deflector plate
- UL® tool attack listed
- S & G® Group II lock with key lock dial and five-year limited warranty

INTERIOR/CONVENIENCE AND APPEARANCE FEATURES

- Premium DPX® Storage System
- Quick Access DPX Barrel Rack
- Four DPX Handgun Pouches
- Integrated Jewelry Box
- NEW Knurled five-spoke Buckmark handle
- Metallic Elk scene bonded to the safe door
- Elevated floor makes removing guns easier
- Baked-on, high-gloss finish

GRADE VI INTERIOR FEATURES

- Premium DPX Storage System with simulated leather trim
- Quick Access DPX Barrel Rack
- Interior cedar sides and ceiling
- Interior light package and full length mirror
- Worn leather look microfiber interior covering

1200° F/120 MIN. STANDARD FIRE PROTECTION

- 1200° F/120 min. fire protection
- Five layers of ½" fire-resistant insulation in the body
- Four layers of ½" fire-resistant insulation in the door
- Premium 3-in-1 Palusol® fire seal for added fire protection



AVAILABLE FINISHES

- Hunter Green Metallic
- Gloss Black
- Black Cherry
- Sand Metallic
- Silver Metallic

INTERIOR COLOR

- Worn Leather/Microfiber

DIMENSIONS

H x W x D



PP56F	72" x 48" x 28"
PP47F	72" x 40" x 28"
PP39F	60" x 40" x 28"

PLATINUM PLUS SAFE SPECIFICATIONS

MODEL	CU. FT.	DIMENSIONS	WEIGHT	BOLTS	GUN CAPACITY/INTERIOR	SUGGESTED RETAIL
PP56F	56	72" x 48" x 28"	1,675 lbs.	28	21/45 + 10 DPX Tall	\$6,249.00
PP47F	47	72" x 40" x 28"	1,470 lbs.	28	22/33 + 10 DPX Tall	5,449.00
PP39F	39	60" x 40" x 28"	1,295 lbs.	24	22/33 + 10 DPX	4,829.00

NOTE: Black Cherry and Silver Metallic finish safes feature silver/chrome handle, dial ring and graphics. The handle, dial ring and graphics for all other finish colors are gold-colored. Scenes are not available on Sand Metallic colored safes.

PLATINUM PLUS SERIES



Pry-Stop Corner Bolt Mechanism

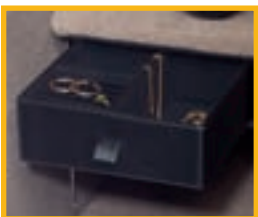

New Jewelry Box



New DPX® Handgun Pouch



1 1/2" Pry-Stop Corner Bolts

NEW

PP56F | PLATINUM PLUS SERIES SAFE
COLOR SHOWN: HUNTER GREEN METALLIC



PP39F | PLATINUM PLUS SERIES SAFE
COLOR SHOWN: GLOSS BLACK

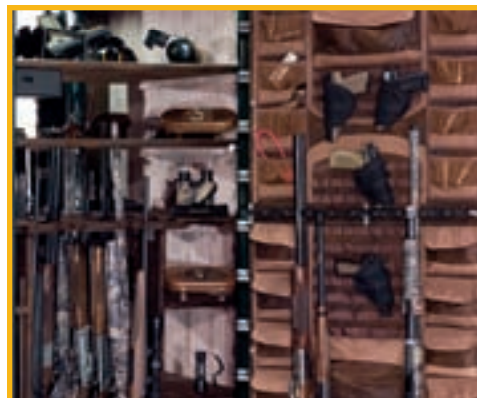

GRADE VI INTERIOR

Platinum Plus Series safes now feature the stunning Grade VI Interior Package. The Grade VI Interior creates an entirely new visual appeal with a full-length mirror on the back and cedar paneling on the sides and ceiling. The shelves are lined with distressed leather-look microfiber, and the DPX® system on the door back panel is trimmed in simulated leather. Quick Access DPX Barrel Racks make for easier access to your long guns stored on the door back.

GOLD SERIES



G65F | GOLD SERIES SAFE
 COLOR SHOWN: SILVER METALLIC
 Shown with optional Mule Deer scene

PROTECTION AS GOOD AS GOLD

WHY STEP UP TO A GOLD SERIES SAFE?

- 65 cubic feet model for ultimate capacity storage
- Additional Uni-Force™ cam and 1½" locking bolts
- Pry-Stop Corner Bolts at all four corners of the door
- Drill-resistant deflector plate
- 1200°/100 min. fire protection
- Interior light package and mirror
- NEW Knurled Buckmark handle

ANTI-PRY FEATURES

- Heavy 10-gauge steel body
- Pry-Stop Corner Bolts at all four corners of the door
- 1½" chromed locking bolts, four-sided door coverage
- Extended throw locking bolts
- Uni-Force Locking System with Anti-Pry Tabs and extension arms
- Fully reinforced integrated door frame
- Tight-tolerance door fit
- 1⅝" thick Duo-Formed® door

ADDITIONAL SECURITY FEATURES

- Uni-Force Locking System with three cams (four on G65F)
- OmniBarrier® Lock Protection System
- Drill-resistant deflector plate
- UL® tool attack listed
- S & G® Group II lock with key lock dial and five-year limited warranty

INTERIOR/CONVENIENCE AND APPEARANCE FEATURES

- Premium DPX® Storage System
- Quick Access DPX Barrel Rack
- Four DPX Handgun Pouches
- NEW Knurled five-spoke Buckmark handle
- Interior light package and mirror
- Metallic Pointer scene bonded to the safe door
- Elevated floor makes removing guns easier
- Baked-on, high-gloss finish

1200° F/100 MIN. STANDARD FIRE PROTECTION

- 1200° F/100 min. fire protection
- Five layers of ½" fire-resistant insulation in the body
- Four layers of ½" fire-resistant insulation in the door
- Premium 3-in-1 Paluso1® fire seal for added fire protection



AVAILABLE FINISHES

- Hunter Green Metallic
- Gloss Black
- Black Cherry
- Sand Metallic
- Silver Metallic

INTERIOR COLORS

- Tan Carpet
- Gray Carpet

DIMENSIONS

H x W x D

G65F	72" x 56" x 28"
G39F	60" x 40" x 28"
G28F	60" x 30" x 27"

GOLD SAFE SPECIFICATIONS

MODEL	CU. FT.	DIMENSIONS	WEIGHT	BOLTS	GUN CAPACITY/INTERIOR	SUGGESTED RETAIL
G65F	65	72" x 56" x 28"	1,620 lbs.	28	21/53 + 13 DPX Tall	\$5,379.00
G39F	39	60" x 40" x 28"	1,135 lbs.	24	22/33 + 10 DPX	3,999.00
G28F	28	60" x 30" x 27"	925 lbs.	24	11/22 + 7 DPX	3,249.00

NOTE: Black Cherry and Silver Metallic finish safes feature silver/chrome handle, dial ring and graphics. The handle, dial ring and graphics for all other finish colors are gold-colored. Scenes are not available on Sand Metallic colored safes.

GOLD SERIES



G39F | GOLD SERIES SAFE
 COLOR SHOWN: HUNTER GREEN METALLIC



G28F | GOLD SERIES SAFE
 COLOR SHOWN: BLACK CHERRY



New Knurled Buckmark Handle



INTERIOR LIGHT PACKAGE AND MIRROR INCLUDED

Gold Series safes include an interior light and mirror package. The package includes two light modules which illuminate the safe interior, and a break-resistant mirror that covers the top half of the rear wall of the safe. The combination gives the safe interior a more spacious feel and makes it easier to find your items in the safe. Factory installed only.



New 1 1/2" Pry-Stop Corner Bolts

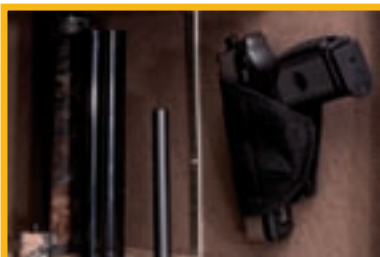

New DPX® Handgun Pouches

MEDALLION SERIES



M56F | MEDALLION SERIES SAFE
 COLOR SHOWN: GLOSS BLACK
 Shown with optional Elk scene

SETTING THE STANDARD FOR PROTECTION AND VALUE

WHY STEP UP TO A MEDALLION SERIES SAFE?

- Heavy, 10-gauge steel body
- OmniBarrier® and Uni-Force™ Systems create a rugged, protected locking mechanism
- Pry-Stop Corner Bolts on two outside corners of door
- Quick Access DPX® Barrel Rack
- Deluxe five-spoke handle
- 1200° F/90 min. fire protection

ANTI-PRY FEATURES

- Heavy, 10-gauge steel body
- Pry-Stop Corner Bolts on the two outside corners of the door
- 1¼" chromed locking bolts, four-sided door coverage
- Extended throw locking bolts
- Uni-Force Locking System with Anti-Pry Tabs and extension arms
- Fully reinforced integrated door frame
- Tight-tolerance door fit
- 1½" thick Duo-Formed® Door

ADDITIONAL SECURITY FEATURES

- Uni-Force Locking System with two cams
- OmniBarrier Lock Protection System
- UL® tool attack listed
- S & G® Group II lock with key lock dial and five-year limited warranty

INTERIOR/CONVENIENCE AND APPEARANCE FEATURES

- Premium DPX Storage System
- Quick Access DPX Barrel Rack
- Four DPX Handgun Pouches
- Deluxe five-spoke handle
- Elevated floor makes removing guns easier
- Metallic Whitetail Buck/Doe scene bonded to the safe door
- Baked-on, high-gloss or rugged textured charcoal finishes

1200°/90 MIN. STANDARD FIRE PROTECTION

- 1200° F/90 min. fire protection
- Four layers of ½" fire-resistant insulation in the body and door (five layers in ceiling)
- Palusol® expanding fire seal

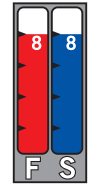

DIMENSIONS

H x W x D

M56F	72" x 48" x 28"
M39F	60" x 40" x 28"
M28F	60" x 30" x 27"



MEDALLION SAFE SPECIFICATIONS

MODEL	CU. FT.	DIMENSIONS	WEIGHT	BOLTS	GUN CAPACITY/INTERIOR	SUGGESTED RETAIL
M56F	56	72" x 48" x 28"	1,365 lbs.	26	21/45 + 10 DPX Tall	\$3,999.00
M39F	39	60" x 40" x 28"	1,050 lbs.	18	24/35 + 10 DPX	3,249.00
M28F	28	60" x 30" x 27"	855 lbs.	18	11/22 + 7 DPX	2,579.00

NOTE: Black Cherry, Silver Metallic and Textured Charcoal finish safes feature silver/chrome handle, dial ring and graphics. The handle and graphics for all other finish colors are gold-colored. Scenes are not available on Sand Metallic colored safes.

AVAILABLE FINISHES

- Textured Charcoal
- Silver Metallic
- Sand Metallic
- Black Cherry
- Gloss Black
- Hunter Green Metallic

INTERIOR COLORS

- Gray Carpet
- Tan Carpet

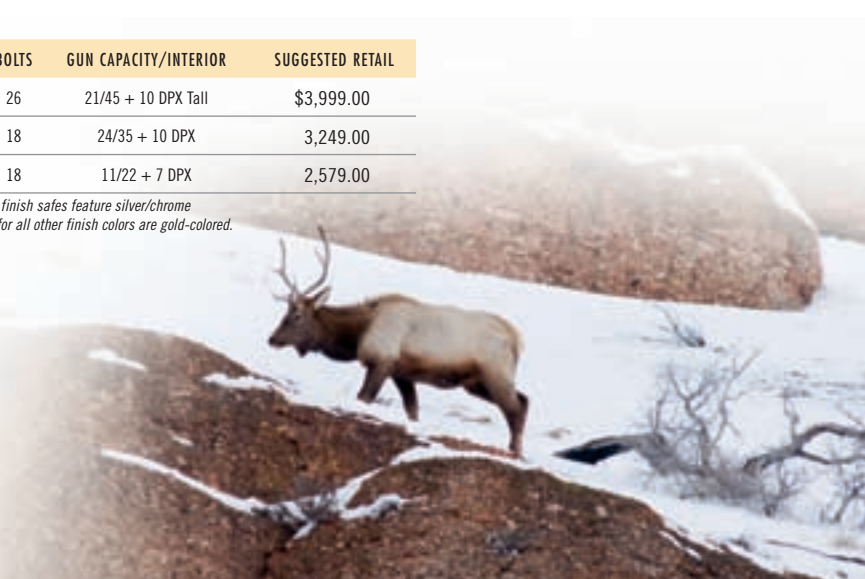

MEDALLION SERIES



M28F | MEDALLION SERIES SAFE
COLOR SHOWN: HUNTER GREEN METALLIC



M39F | MEDALLION SERIES SAFE
COLOR SHOWN: BLACK CHERRY

NEW



Pry-Stop Corner Bolt Mechanism

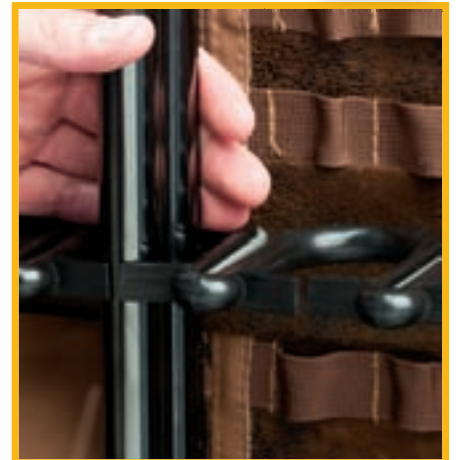

Quick Access DPX® Barrel Racks

SILVER SERIES **NEW**



SR26F | SILVER SERIES SAFE
COLOR SHOWN: GLOSS BLACK

AUTHENTIC VALUE

WHY STEP UP TO A SILVER SERIES SAFE?

- 11-gauge steel body
- 1½" thick Duo-Formed® Door with full inner plate
- 1¼" door bolts on all four sides for extra security
- 1200°/60 min. fire protection
- Full DPX® Storage System
- Attractive wildlife scene available

ANTI-PRY FEATURES

- Rugged 11-gauge steel body
- Pry-Stop End Bolts
- 1¼" chromed locking bolts, four-sided door coverage
- Extended throw locking bolts
- Fully reinforced integrated door frame
- Tight-tolerance door fit
- 1½" thick Duo-Formed door

ADDITIONAL SECURITY FEATURES

- Force Deflector™ locking mechanism
- Hardened steel pin lock protection
- UL® tool attack listed
- S & G® Group II lock with key lock dial and five-year limited warranty

INTERIOR/CONVENIENCE AND APPEARANCE FEATURES

- DPX Storage System
- Four DPX Handgun Pouches
- Deluxe three-spoke handle
- Elevated floor makes removing guns easier
- Metallic Mallard scene bonded to the safe door
- Baked-on, high-gloss or rugged textured charcoal finishes

1200°/60 MIN. STANDARD FIRE PROTECTION

- 1200° F/60 min. fire protection
- Three layers of ½" fire-resistant insulation in the safe body and door
- Palusol® expanding fire seal

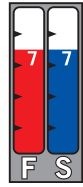

AVAILABLE FINISHES

- Hunter Green Metallic
- Gloss Black
- Black Cherry
- Silver Metallic
- Textured Charcoal

INTERIOR COLORS

- Tan Carpet
- Gray Carpet

SILVER SAFE SPECIFICATIONS

MODEL	CU. FT.	DIMENSIONS	WEIGHT	BOLTS	GUN CAPACITY/ INTERIOR	SUGGESTED RETAIL (GLOSS FINISH)	SUGGESTED RETAIL (TEXTURED FINISH)
SR42F	42	72" x 37" x 27"	940 lbs.	16/10 active	20/30 + 10 DPX Tall	\$2,929.00	\$2,729.00
SR35F	35	60" x 37" x 27"	820 lbs.	16/10 active	20/30 + 10 DPX	2,649.00	2,479.00
SR26F	26	60" x 30" x 25"	690 lbs.	16/10 active	10/20 + 7 DPX	2,129.00	1,999.00

NOTE: Black Cherry, Silver Metallic and Textured Charcoal finish safes feature silver/chrome handle, dial ring and graphics. The handle, dial ring and graphics for all other finish colors are gold-colored.

DIMENSIONS



H x W x D

SR42F	72" x 37" x 27"
SR35F	60" x 37" x 27"
SR26F	60" x 30" x 25"

SILVER SERIES **NEW**



SR35F | SILVER SERIES SAFE
COLOR SHOWN: SILVER METALLIC

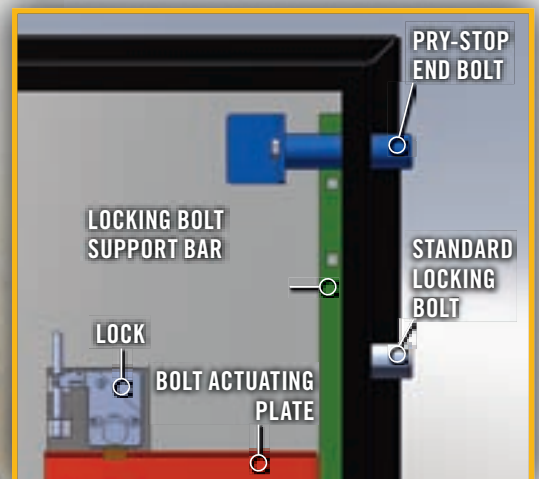

Pry-Stop End Bolt Mechanism

BRONZE SERIES

AFFORDABLE SECURITY

WHY STEP UP TO A BRONZE SERIES SAFE?

- 1200° F/45 min. fire protection
- Pry-Stop End Bolts for better pry resistance
- Available in premium gloss or rugged textured charcoal finishes
- Three-spoke handle
- DPX® Storage System

ANTI-PRY FEATURES

- 12-gauge steel body
- Pry-Stop End Bolts
- 1" chromed locking bolts, three-sided door coverage
- Extended throw locking bolts
- Fully reinforced integrated door frame
- Tight-tolerance door fit
- 1" formed door

ADDITIONAL SECURITY FEATURES

- Force Deflector™ Locking System
- Hardened steel pin lock protection
- UL® tool attack listed
- S & G® Group II lock with key lock dial and five-year limited warranty

INTERIOR/CONVENIENCE AND APPEARANCE FEATURES

- DPX Storage System on top half of door back
- Two DPX Handgun Pouches
- Deluxe three-spoke handle
- Elevated floor makes removing guns easier
- Scroll graphic on the door
- Baked-on, high-gloss or rugged textured charcoal finishes

1200°/45 MIN. STANDARD FIRE PROTECTION

- 1200° F/45 min. fire protection
- Two layers of ½" fire-resistant insulation in the body and door
- Palusol® expanding fire seal



BR24F | BRONZE SERIES SAFE
COLOR SHOWN: GLOSS BLACK



DPX® STORAGE SYSTEM

Bronze Series safes include the DPX Storage System, with the pouch and pocket system on the top half of the door back panel. Long guns can be stored on the door back, and handguns and other small valuables can be stored easily in the pouches and pockets on the top half of the door back.

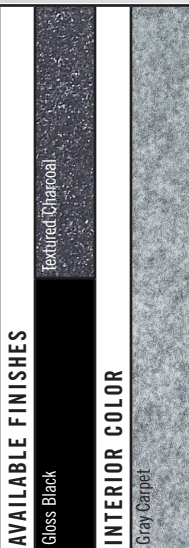

DIMENSIONS

H x W x D

BR41F	60" x 44" x 27"
BR34F	60" x 36" x 27"
BR24F	60" x 30" x 23"
BR16F	60" x 24" x 19"

BRONZE SAFE SPECIFICATIONS

MODEL	CU. FT.	DIMENSIONS	WEIGHT	BOLTS	GUN CAPACITY/INTERIOR	SUGGESTED RETAIL (GLOSS FINISH)	SUGGESTED RETAIL (TEXTURED FINISH)
BR41F	41	60" x 44" x 27"	805 lbs.	14/8 active	20/42 + 10 DPX	\$2,449.00	\$2,229.00
BR34F	34	60" x 36" x 27"	705 lbs.	14/8 active	20/30 + 10 DPX	2,099.00	1,879.00
BR24F	24	60" x 30" x 23"	535 lbs.	14/8 active	9/18 + 7 DPX	1,529.00	1,429.00
BR16F	16	60" x 24" x 19"	425 lbs.	9/5 active	7/14 + 5 DPX	1,379.00	1,249.00

NOTE: Textured Charcoal finish safes feature silver/chrome handle, dial ring and graphics. The handle and graphics on Gloss Black finish safes are gold-colored.



BR16F | BRONZE SERIES SAFE
COLOR SHOWN: TEXTURED CHARCOAL

THEFTGARD

REAL SAFES AT A REAL VALUE

THEFTGARD

- New features and sizes for 2010
- 1200° F/30 min. fire protection
- Thick 1" formed door with three-sided locking bolts
- Duo-Plus™ Interior with long gun storage on the door

ANTI-PRY FEATURES

- 12-gauge steel body
- 1" chromed locking bolts, three-sided door coverage
- Extended throw locking bolts
- Fully reinforced integrated door frame
- Tight tolerance door fit
- 1" formed door

ADDITIONAL SECURITY FEATURES

- Force Deflector™ Locking System
- Hardened steel pin lock protection
- UL® tool attack listed
- S & G® Group II lock with key lock dial and five-year limited warranty

INTERIOR/CONVENIENCE AND APPEARANCE FEATURES

- Duo-Plus Interior for long gun storage on the door
- Premium straight handle
- Elevated floor makes removing guns easier
- Scroll graphic on the door
- Rugged textured finish

1200°/30 MIN. STANDARD FIRE PROTECTION

- 1200° F/30 min. fire protection
- One layer of ½" fire-resistant insulation in the body
- Two layers of ½" fire-resistant insulation in the door and ceiling
- Palusol® expanding fire seal



TG41F JUDGE | THEFTGARD SAFE
COLOR SHOWN: HAMMER GRAY



TG23F MARSHAL | THEFTGARD SAFE
COLOR SHOWN: HAMMER BROWN

DUO-PLUS™ INTERIOR

TheftGard safes include the patent pending Duo-Plus Interior, which allows for the storage of your long guns on the door back panel. This previously unused space becomes easy-to-access storage for long guns.

The configuration of the shelf and gun rack system inside the safe is convertible from part shelf/part long gun to all long gun.



1" Formed Door and Top Bolt

AVAILABLE FINISHES

Hammer Gray

INTERIOR COLORS

Gray Carpet

Hammer Brown

Tan Carpet

THEFTGARD SAFE SPECIFICATIONS

MODEL	CU. FT.	DIMENSIONS	WEIGHT	BOLTS	GUN CAPACITY/INTERIOR	SUGGESTED RETAIL
TG41F	41	72" x 36" x 27"	705 lbs.	13/7 active	20/30 + 10 Duo-Plus Tall	\$2,049.00
TG33F	33	58" x 36" x 27"	600 lbs.	13/7 active	20/30 + 10 Duo-Plus	1,599.00
TG23F	23	58" x 30" x 23"	510 lbs.	13/7 active	9/18 + 7 Duo-Plus	1,129.00
TG15F	15	58" x 24" x 18"	410 lbs.	9/5 active	7/14 + 5 Duo-Plus	999.00

NOTE: Hammer Gray safes feature silver/chrome hardware and graphics. Hammer Brown safes have gold/brass hardware and graphics.

DIMENSIONS

H x W x D

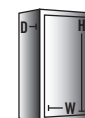

TG41F	72" x 36" x 27"
TG33F	58" x 36" x 27"
TG23F	58" x 30" x 23"
TG15F	58" x 24" x 18"

TACTICAL SERIES MARK II

NEW



AR26F | TACTICAL MARK II SERIES SAFE

UTILITY AND STYLE

MARK II KEY FEATURES

- Heavy 11-gauge steel body
- Conveniently holds shorter guns
- Interior mirror and light package make finding items easier
- External Accessory Rack makes it easy to hang gear on side of safe

ANTI-PRY FEATURES

- Heavy 11-gauge steel body
- Pry-Stop End Bolts
- 1¼" chromed locking bolts, four-sided door coverage
- Extended throw locking bolts
- Fully reinforced integrated door frame
- Tight-tolerance door fit
- 1½" thick Duo-Formed® door

OTHER SECURITY FEATURES

- Force Deflector™ Locking Mechanism
- Hardened steel pin lock protection
- UL® tool attack listed
- S & G® Type I Electronic Lock with five-year limited warranty

INTERIOR/CONVENIENCE AND APPEARANCE FEATURES

- DPX® Storage System with loops for short barrel guns
- Four DPX Handgun Pouches
- Tactical-look single handle
- Safe Top Storage Basket conveniently stores gear on safe
- Side Rails and External Accessory Rack for hanging items outside safe
- Rubber-coated shelves
- Picatinny rails make for easy mounting of accessories inside safe
- Key fob holder and small item tray for even more storage versatility
- Full-length mirrored back panel and interior light package
- Raised-dot rubber floor panel
- Elevated floor makes removing guns easier
- Cast Browning name plate
- Dull Black finish

1200° F/60 MIN. STANDARD FIRE PROTECTION

- 1200° F/60 min. fire protection
- Three layers of ½" fire-resistant insulation in the safe body and door
- Palusol® expanding fire seal

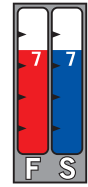

DIMENSIONS

H x W x D



AR35F	60" x 37" x 27"
AR26F	60" x 30" x 25"
AK33F	58" x 36" x 27"
AK23F	58" x 30" x 23"

TACTICAL SAFE SPECIFICATIONS

MODEL	CU. FT.	DIMENSIONS	WEIGHT	BOLTS	GUN CAPACITY/INTERIOR	SUGGESTED RETAIL
AR35F (MARK II)	35	60" x 37" x 27"	860 lbs.	16/10 active	20/30 + 10 DPX	\$3,129.00
AR26F (MARK II)	26	60" x 30" x 25"	725 lbs.	16/10 active	10/20 + 7 DPX	2,599.00
AK33F (MARK I)	33	58" x 36" x 27"	715 lbs.	14/8 active	20/30 + 10 DPX	2,629.00
AK23F (MARK I)	23	58" x 30" x 23"	545 lbs.	14/8 active	9/18 + 7 DPX	2,099.00

Overall dimensions of AR35F and AR26F are 6" wider than shown and 4" taller than shown due to Top Basket and Side Rails. Models AK33F and AK23F are 4" taller than shown due to Top Basket.

AVAILABLE FINISH

Dull Black

INTERIOR COLOR

Gray Carpet

TACTICAL SERIES MARK I

NEW

AK33F | TACTICAL MARK I SERIES SAFE

UTILITY AND STYLE**MARK I KEY FEATURES**

- Conveniently stores shorter guns
- Safe Top Storage Basket makes great use of space on top of safe
- Pry-Stop End Bolts provide excellent pry resistance

ANTI-PRY FEATURES

- 12-gauge steel body
- Pry-Stop End Bolts
- 1" chromed locking bolts, 3-sided door coverage
- Extended throw locking bolts
- Fully reinforced integrated door frame
- Tight-tolerance door fit
- 1" Formed door

OTHER SECURITY FEATURES

- Force Deflector™ Locking Mechanism
- Hardened steel pin lock protection
- UL® tool attack listed
- S & G® Type I Electronic Lock with five-year limited warranty

INTERIOR/CONVENIENCE AND APPEARANCE FEATURES

- DPX® Storage System with loops for short barrel guns
- Four DPX handgun pouches
- Tactical-look single handle
- Safe Top Storage Basket conveniently stores gear on safe
- Picatinny rails make for easy mounting of accessories inside safe
- Half-height mirrored back panel
- Raised-dot rubber floor panel
- Elevated floor makes removing guns easier
- Cast Browning name plate
- Dull Black finish

1200° F/45 MIN. STANDARD FIRE PROTECTION

- 1200° F/45 min. fire protection
- Two layers of ½" fire-resistant insulation in the safe body and door
- Palusol® expanding fire seal

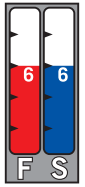
12 GA
BODY

1" DOOR

PRY-STOP
END BOLTS3-WAY
BOLTS

180°

DPX

UL

2 LAYERS
INSULATION

1200°/45

UL LISTED 1P60
GUN SAFE

AR35F Interior



AK23F Interior



Short Guns on DPX®

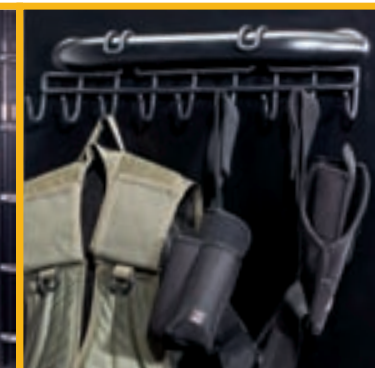

Mark II External Accessory Rack

SELECT SERIES

NEW



EXCLUSIVE VALUE

KEY FEATURES

- Available exclusively from Browning Full Line and Medallion Dealers
- Interior light package and mirror
- Whitetail Buck/Doe scene or scroll graphics

ANTI-PRY FEATURES

- 12-gauge steel body
- Pry-Stop End Bolts
- 1" chromed locking bolts, three-sided door coverage
- Extended throw locking bolts
- Fully reinforced integrated door frame
- Tight-tolerance door fit
- 1" Formed door

OTHER SECURITY FEATURES

- Force Deflector™ Locking Mechanism
- Hardened steel pin lock protection
- UL® tool attack listed
- S & G® Group II lock with key lock dial and five-year limited warranty

INTERIOR/CONVENIENCE AND APPEARANCE FEATURES

- DPX® Storage System
- Two DPX Handgun Pouches
- Interior light package and mirror on top half of back
- Deluxe three-spoke handle
- Elevated floor makes removing guns easier
- Available with either Whitetail Buck/Doe scene or scroll graphic on the safe door
- Baked-on, high-gloss finish

1200° F/45 MIN. STANDARD FIRE PROTECTION

- 1200° F/45 min. fire protection
- Two layers of ½" fire-resistant insulation in the safe body and door
- Palusol® expanding fire seal

ST34F | SELECT SERIES SAFE

Shown with Whitetail Buck/Doe Scene

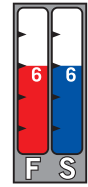

Select Safes are available only from Browning Full Line Dealers and Medallion Dealers.

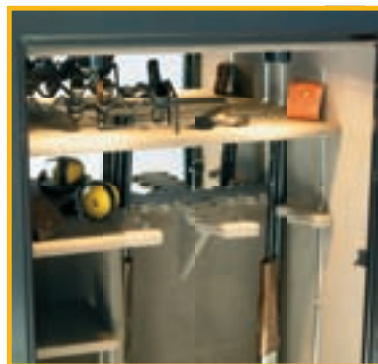

INTERIOR LIGHT PACKAGE AND MIRROR INCLUDED

Select Series safes boast an interior light and mirror package. The package includes two light modules, which illuminate the safe interior, and a break-resistant mirror that covers the top half of the rear wall of the safe. The combination gives the safe interior a more spacious feel and makes it easier to find items in the safe. Factory installed only.

AVAILABLE FINISH

Gloss Black

INTERIOR COLOR

Tan Carpet



DIMENSIONS

H x W x D

ST34F	60" x 36" x 27"
ST24F	60" x 30" x 23"

SELECT SAFE SPECIFICATIONS

MODEL	CU. FT.	DIMENSIONS	WEIGHT	BOLTS	GUN CAPACITY/INTERIOR	SUGGESTED RETAIL
ST34F	34	60" x 36" x 27"	710 lbs.	14/8 active	20/30 + 10 DPX	\$2,249.00
ST24F	24	60" x 30" x 23"	540 lbs.	14/8 active	9/18 + 7 DPX	1,729.00



Hardened Pin Lock Protection for drill resistance

HERITAGE GRAPHICS

Now it is possible to show your allegiance to these great organizations that work to preserve our rights and hunting heritage. The Heritage Graphics option can be ordered to replace the game scene on many safes. You can support your favorite organization by proudly showing its logo and graphics on a gorgeous Browning ProSteel Safe.

Browning makes a donation to the respective organization for each Heritage Graphics option sold. Available only on Hunter Green Metallic or Gloss Black safes in the Platinum® Plus, Gold®, Medallion® and Silver™ Series models.



DUCKS UNLIMITED®

For more than seventy years, Ducks Unlimited has been the leader in waterfowl and wetlands conservation in North America • Metallic *Mallards* scene by David Jackson bonded to surface of safe door



ROCKY MOUNTAIN ELK FOUNDATION®

The mission of the Rocky Mountain Elk Foundation is to ensure the future and conservation of elk and their habitat through education • Metallic *Pass It On* scene bonded to surface of safe door



NATIONAL WILD TURKEY FEDERATION®

Since the inception of the National Wild Turkey Federation in 1973, the number of wild turkeys in the United States has more than tripled. The NWTF is dedicated to conserving wild turkeys and their habitat • Metallic *Struttin' Grounds* scene bonded to surface of safe door



NATIONAL RIFLE ASSOCIATION®

No single group has done more to protect the Second Amendment rights of the American citizen "to keep and bear arms" than the National Rifle Association • Metallic *Eagle* scene by Brent Evans bonded to the surface of the safe door

ALL HERITAGE GRAPHICS OPTIONS SHOWN ON MODEL SR26F.



HERITAGE GRAPHICS DU
COLOR SHOWN: GLOSS BLACK



HERITAGE GRAPHICS NWTF
COLOR SHOWN: HUNTER GREEN



HERITAGE GRAPHICS RMEF
COLOR SHOWN: HUNTER GREEN



HERITAGE GRAPHICS NRA
COLOR SHOWN: GLOSS BLACK

Shown with optional electronic lock

COMPACT SERIES

COMPACT SIZE — LOADED WITH FEATURES

A premium, scaled-down Browning ProSteel Safe. A Compact Series safe is the perfect size safe for smaller valuables such as jewelry, cameras, handguns or wherever space is at a premium.

COMPACT SERIES FEATURES

- 12-gauge steel body
- 1" formed steel door
- Force Deflector™ Locking Mechanism
- Hardened steel pin lock protection
- 1" chromed locking bolts
- Internal hinge system
- UL® tool attack listed
- Two layers of ½" fire-resistant insulation in the body and door
- 1200° F/45 min. fire protection
- Palusol® expanding fire seal
- Type I Electronic Lock
- Baked on high gloss finish
- Gray two-shelf interior



H9F | COMPACT SAFE

AVAILABLE FINISH
Gloss Black

INTERIOR COLOR
Gray Carpet

DIMENSIONS
H x W x D

H9F 30" x 24" x 20"
Interior dimensions: 27" x 21¼" x 14"

COMPACT SAFE SPECIFICATIONS

MODEL	CU. FT.	DIMENSIONS	WEIGHT	BOLTS	GUN CAPACITY/INTERIOR	SUGGESTED RETAIL
H9F	9	30" x 24" x 20"	275 lbs.	3	2-Shelf/Gray	\$949.00

GAME SCENE SELECTION

AVAILABLE ON PLATINUM® PLUS, GOLD®, MEDALLION® AND SILVER™ MODELS

Each series (Platinum, Gold, etc.) has a standard metallic game scene. These scenes are permanently bonded to the door and can be applied only at the factory.



BUCKMARK SCENE



PREMIUM SAFE SCROLL



POINTER SCENE
BY LUKE FRAZIER

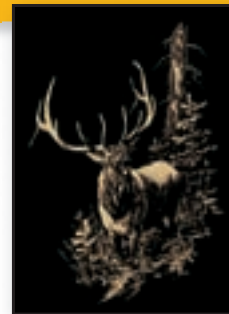

ELK SCENE
BY LEON PARSON

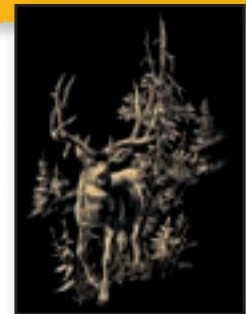

MULE DEER SCENE
BY DAVID JACKSON

NEW

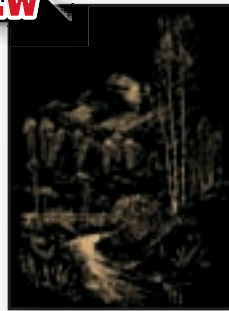

MOUNTAIN SCENE
BY DAVID JACKSON

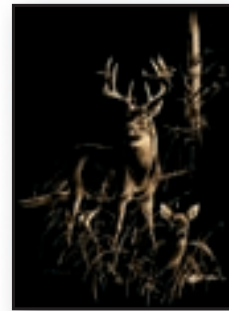

WHITETAIL BUCK/DOE SCENE
BY LUKE FRAZIER

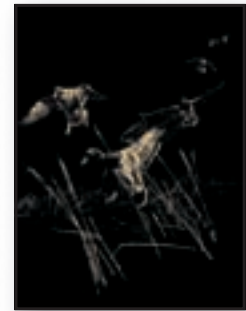

MALLARDS SCENE
BY LUKE FRAZIER

DVD



Call (800) 333-3504 to get a free DVD or VHS copy of the Browning ProSteel Safes sales video. This sales tool explains what makes Browning The Best There Is® in the safe industry. The video is also viewable at browning.com. This video will help you understand important gun safe features that contribute to security and fire protection.

UNIVERSAL VAULT DOOR

TURN AN ENTIRE ROOM INTO A VAULT

- Designed to fit a variety of wall types and installation requirements
- The minimum rough door opening for the Vault Door is 83" x 36"
- External L-frame with ½" diameter steel J-bolt anchors (included) can be poured in place in new construction or installed in an existing door frame by using expansion anchors or lag bolts (not included)

UNIVERSAL VAULT DOOR FEATURES

- Door frame "L-flange" will fit any wall with a minimum thickness of 5½"
- 1⅝" thick Duo-Formed® door
- 22 1¼" chromed locking bolts
- OmniBarrier® Lock Protection System
- Uni-Force™ Locking System
- 1½" of fire-resistant insulation in the door
- NEW Knurled five-spoke Buckmark handle
- External ball-bearing hinges
- Palusol® expanding fire seal
- UL® Listed S & G® Type I Electronic Lock
- Also available with a black primered finish, allowing you to paint to match any decor
- Internal lock release to open the door from within the vault



UNIVERSAL VAULT DOOR
COLOR SHOWN: HUNTER GREEN METALLIC
Shown with Whitetail Buck/Doer scene

- AVAILABLE FINISHES**
- Primer Black
 - Silver Metallic
 - Sand Metallic
 - Black Cherry
 - Gloss Black
 - Hunter Green Metallic

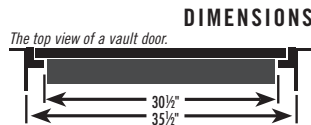

Internal Lock Release

MADE IN USA

UNIVERSAL VAULT DOOR SPECIFICATIONS

MODEL	WEIGHT	BOLTS	DOOR CONSTRUCTION	SUGGESTED RETAIL (GLOSS FINISH)	SUGGESTED RETAIL (PRIMER FINISH)
Vault Door	645 lbs.	22	10-gauge/12-gauge	\$3,079.00	\$2,849.00

NOTE: The vault door is manufactured with an electronic lock which provides an internal lock release. Vault Door is not available with mechanical lock. Universal "L" frame design fits all wall thicknesses from 5½" and larger. Vault door back panel has gray carpet. Game scenes are optional with gloss finish Vault Doors — specify desired scene or scroll on order. Scenes are not available in Sand Metallic colored vault doors.

Black Cherry and Silver Metallic finish safes feature silver/chrome handle, dial ring and graphics. The handle, dial ring and graphics for all other finish colors are gold-colored.

SECURITY DOOR

BUILT-IN CONCEALMENT AND SECURITY

The Browning ProSteel Security Door has taken in-home security to a new level. With the appearance of a standard residential door, the Security Door is the perfect option if you prefer to be more discreet about the presence and location of your valuables. The Security Door includes a UL® Listed S & G® Type I Electronic Lock with a keypad that can be mounted and concealed up to seven feet from the vault to further hide the true nature of the door. The Security Door features a six-panel door style to help blend in with other residential doors and can be painted to match. The minimum rough door opening for the Security Door is 83" x 36".

SECURITY DOOR FEATURES

- 1⅝" thick Duo-Formed® type door
- 1¼" chromed locking bolts
- 1" of fire-resistant insulation in the door face
- Residential interior straight brass handle
- UL® Listed S & G® Type I Electronic Lock
- Concealed hinges
- Internal lock release to open the door from within the vault
- Door swings out a full 180° when open

SECURITY DOOR SIX-PANEL

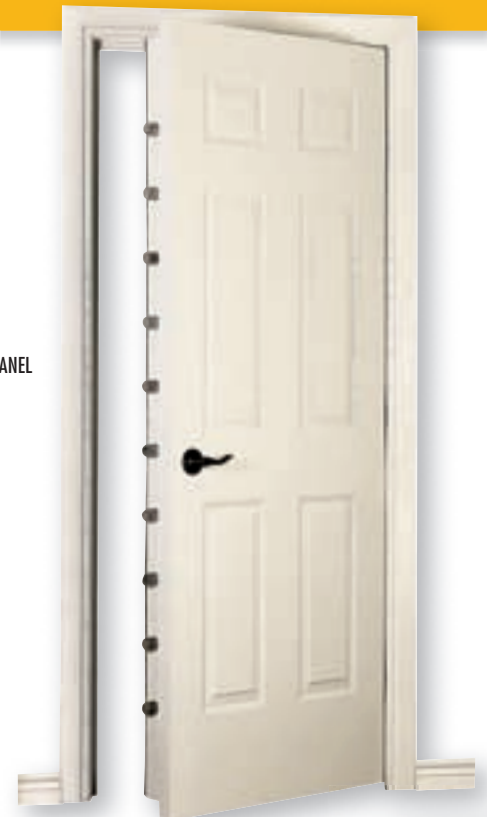

MADE IN USA

SECURITY DOOR SPECIFICATIONS

MODEL	WEIGHT	BOLTS	DOOR CONSTRUCTION	SUGGESTED RETAIL
Security Door	500 lbs.	20/10 active	12-gauge/14-gauge	\$3,599.00

- AVAILABLE FINISH**
- White Primer

USER-INSTALLED ACCESSORIES

The safe accessories shown on this page are easily installed. New Browning ProSteel Safes are shipped pre-drilled with a molded fire-resistant electrical pass-through sleeve installed in the safe to accommodate the power cord for a light kit or dehumidifier.



EVERDRY™ ELECTRIC DEHUMIDIFIER

The EverDry Electric Dehumidifier removes humidity from the interior of a safe and protects against rust. The 18" long EverDry should be used on safes 30" wide and larger. Cord is removable for installation.

Suggested Retail: \$29.95

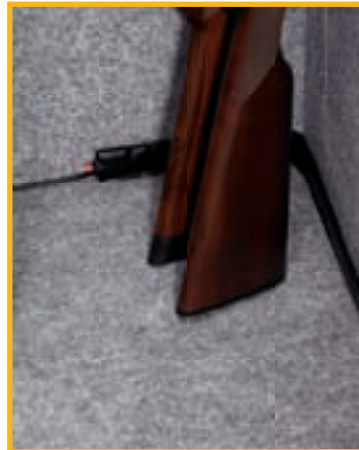

FLEXIBLE EVERDRY™ ELECTRIC DEHUMIDIFIER

The Flexible EverDry is flat and easily bends to take up less space and makes installation easier, especially in small safes. Removes humidity from the interior of a safe and protects against rust. Plug is removable for installation. LED indicates unit is operating.

Suggested Retail: \$39.95



DRY-ZONE

Absorbs moisture without electricity, and is rechargeable in an oven. It can be reactivated indefinitely. One 500-gram box protects up to 37 cubic feet of enclosed space, about the volume of a standard 30" wide safe.

Suggested Retail: \$19.95

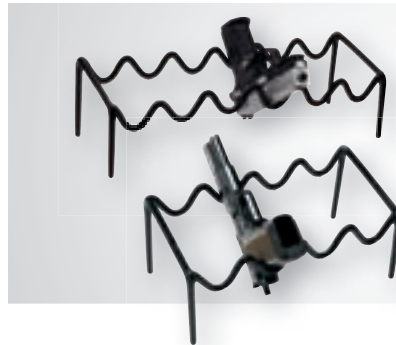

PISTOL RACK

Store handguns more efficiently and increase storage space on shelves. Access to handguns is made easier by placing them in an upright position. 4 or 6 capacity gun models available.

Suggested Retail: \$24.95 — 6-Gun
Suggested Retail: \$18.95 — 4-Gun



NEW

DPX® HANDGUN POUCHES

Store more handguns in your safe with the versatile new DPX Handgun Pouches. These versatile pouches include snap-straps to allow use on the MOLLE System used on the DPX and also hook and loop fasteners for use on carpeted interior surfaces. Set of two. Not intended for use as a holster.

Suggested Retail: \$24.95

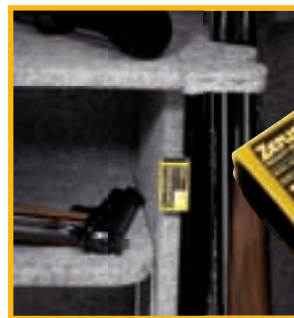

ZERUST® PROTECTANT

Small capsule emits an invisible vapor that forms a corrosion- and rust-resistant barrier on metal surfaces. Volatile Corrosion Inhibitors (VCIs) have been used for years to protect metal parts in industrial and commercial applications. One capsule protects a standard 30" wide safe for one year.

Suggested Retail: \$7.99



VCI GUN SOCKS

Browning's VCI (Vapor Corrosion Inhibitor) Gun Sock seals out moisture. VCI penetrates into the smallest crevices where oils cannot reach, driving out moisture. Provides full protection by forming a vapor enclosure around your firearm from muzzle to butt. The VCI Sock, when used in a safe or cabinet, will offer additional protection to all metal items in the enclosed area. One size fits most firearms.

Suggested Retail: \$14.95

FACTORY-INSTALLED ACCESSORIES



NEW

JEWELRY BOX

The new Jewelry Box option makes storing and finding jewelry inside a safe much easier and more convenient. The elegant Jewelry Box conveniently holds jewelry and small items inside the safe in an organized, protected manner. Exterior is synthetic leather; interior is lined with jeweler's velvet. Mounted on half shelf below gun rack on most safe models.

Optional on Gold®, Medallion® and Silver™ Series safes.

Standard on Platinum® Plus Series safes.

Factory installed only

Suggested Retail: \$59.95

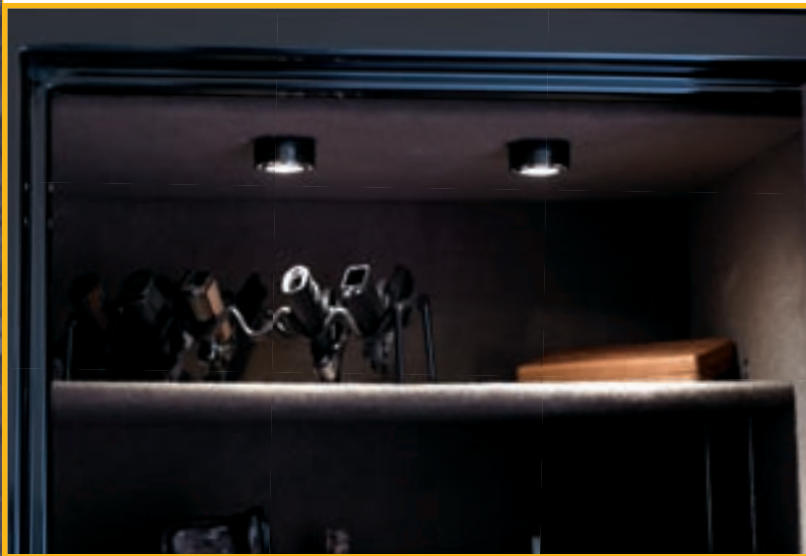

MEDALLION/SILVER SERIES LIGHT PACKAGE OPTION

This integrated lighting package makes locating objects on shelves or identifying the right firearm convenient and easy. The two included light modules are wired to a door activated switch and illuminate when the door is opened. Factory installation adds a seamless look with no exposed wiring.

Optional on Medallion and Silver Series safes.

Standard on Platinum Plus and Gold Series safes.

Factory installed only

Suggested Retail: \$129.00



MEDALLION/SILVER SERIES MIRROR OPTION

Located on the top half of the back wall, the mirror option looks great and brightens the interior of the safe to make objects, especially those on the rear of the shelves, easier to find. Constructed of break-resistant material for durability.

Optional on Medallion and Silver Series safes.

Standard on Platinum Plus (full length) and Gold Series safes.

Factory installed only

Suggested Retail:

Regular (Fits 28 or 26 cubic foot models)	\$49.00
Wide (Fits 39 or 35 cubic foot models)	59.00
Wide/Tall (Fits 56 or 42 cubic foot models)	89.00

LOCK OPTIONS

The locks below are available as factory-installed options. Availability by series is described in the information for each lock.

S & G® ELECTRONIC LOCK

The S & G Electronic Lock is an advanced security system manufactured by the leader in the lock industry. Includes many technical security features.

Available on all models.

SECURAM™ BIOMETRIC LOCK

The SecuRam Biometric Lock uses the uniqueness of an individual fingerprint as the combination in this advanced security solution. The lock opens with either a fingerprint or a multi-digit code. It is highly secure and operates very quickly. Simple programming instructions. LCD Screen.

Not available on TheftGard, Bronze, Compact Series safes and the Security Door



LOCK FEATURE COMPARISON



S & G® Electronic Lock

	S & G ELECTRONIC LOCK	SECURAM BIOMETRIC LOCK
NUMBER OF USERS:	Up to 9	Up to 30
BATTERY:	One 9 volt	One 9 volt
BOLT ACTIVATION:	Solenoid	Motor
LOCK OUT FEATURE:	After three failed attempts, lock out for five minutes	After three failed attempts, lock out for five minutes
TIME DELAY:	User programmable	User programmable
SUGG. RETAIL:	\$89.00	\$279.00



SecuRam Biometric Lock

GUN SAFE WARRANTY

ProSteel offers a Gun Safe Warranty equal to the best in the industry. Browning ProSteel Safes manufactured after January 1, 2006 include a generous warranty that covers:

- ATTEMPTED BREAK IN • BREAK IN • FIRE

If a safe has one of these situations and your homeowner's insurance policy does not cover the damage to the safe, ProSteel will repair or replace the safe. Contents are not covered. Shipping costs for new safe, if necessary, are included.

Some restrictions apply. See Safe Owner's Manual or Browning.com for complete warranty information. Workmanship warranty information is included.









GUN CASES

GUN CASES INDEX

BEAR RIVER FLOATER CASES	115
FITTED PRESENTATION CASES	
Canvas Over/Under	110
Crazy Horse Distressed Leather	111
High Grade Canvas/Crazy Horse Leather	110
John M. Browning Signature	111
Leather/Canvas Series	109
Leather/Canvas Motor Case	109
Santa Fe Waxed Canvas	110
Sporter	109
Traditional	108
Wild Boar	107
FLEXIBLE CASES	
Bear River Floater	115
Cimmaron	113
Flex Foam Buck Mark Pistol/Cimmaron	113
Plainsman	113
Ridge	114
Sheridan/Santa Fe	114
Talon	115
Wild Boar	115
GUN SLIPS, Plainsman	113
GUN SOCKS	115
MOLDED CASES	
Mirage	111
Bruiser	112
TALON ALUMINUM CASES	112

FITTED PRESENTATION CASE CLASSIFICATION KEY

			34"	34"+				
Stock/Receiver Capacity	Barrel Capacity	Indicates Bore and Gauge Designation	Indicates Maximum Barrel Length in Inches	Barrels Will Fit with Extended Choke Tubes Installed	Case Holds BT Style Guns	Case Holds Auto/Pump Style Guns	Case Holds Over/Under Style Guns	Rifle Case

WILD BOAR CASE

NEW







SHELL - Solid wood frame · Textured synthetic pigskin · Synthetic leather trim

PADDING TYPE - Soft microsuede lining with movable high-density foam support blocks

HINGE - Four hidden antique brass-plated hinges

LATCH - Three antique brass-plated latches

SPECIAL FEATURES - Magnetic-hold choke tube compartment · Antique brass-plated corner guards

    32"+  (Except Citori Trap or Skeet)

DESCRIPTION	COLOR	DIMENSIONS	CODE #	SUGG. RETAIL
NEW Wild Boar Fitted Gun Case	Sage/Brown	34" x 10½" x 3¾"	1421044212	\$249.95

TRADITIONAL CASES

An attractive, fitted gun case enhances and shows your appreciation for the firearm it carries. To protect a fine Browning firearm, there is not a better choice than a Browning Fitted Presentation Case. Handsome on the outside, soft and padded on the inside, a fitted case offers customized protection for your firearms. Features include sturdy, rugged shells, water-repellent coatings, brass corner accents, deep pile fleece linings, solid wood framing, accessory compartments and other elegant features to properly transport your favorite firearms.

AVAILABLE COLORS:



Classic Brown

Black/Tan

AVAILABLE INTERIORS:



1 ▶ BT-Style Single Barrel Trap Shotgun Case



2 ▶ Autoloading and Pump Shotgun



3 ▶ Over/Under Shotgun Case



4 ▶ Semi-Automatic 22 Rifle Case



- SHELL - Rugged wood construction covered with expanded vinyl
- PADDING TYPE - Deep pile fleece with fabric-covered positioning blocks
- HINGES - Three brass-plated hinges
- LATCH - One or two key locks
- SPECIAL FEATURES - Brass corner accents · Folding handle · Accessory compartment

DESCRIPTION	CLASSIFICATION	DIMENSIONS	COLOR	CODE #	SUGG. RETAIL
1 ▶ Traditional BT-Style Single Barrel Trap Case	1 34"	35½" x 8¾" x 3¾"	Classic Brown	142810	\$249.95
1 ▶ Traditional BT-Style Single Barrel Trap Case	1 34"	35½" x 8¾" x 3¾"	Black/Tan	1428119410	249.95
2 ▶ Traditional Auto/Pump Shotgun Case	2 32"	35½" x 10½" x 3¾"	Classic Brown	142820	274.95
3 ▶ Traditional Universal O/U, BT Trap Case	1 34"+	35½" x 9" x 3½"	Classic Brown	1428118408	249.95
3 ▶ Traditional Universal O/U, BT Trap Case	1 34"+	35½" x 9" x 3½"	Black/Tan	1428119408	249.95
Traditional O/U Shotgun Case (Except Citori Trap or Skeet) (not shown)	1 32"	33" x 8¾" x 3"	Classic Brown	142841	224.95
Traditional O/U Shotgun Case (Except Citori Trap or Skeet) (not shown)	1 30"	31" x 8¾" x 3"	Classic Brown	142840	209.95
Traditional O/U Shotgun Case for Citori Trap or Skeet (not shown)	1 32"	33¼" x 8¾" x 4½"	Classic Brown	142880	249.95
Traditional O/U w/ Extra Barrel Case (Except Citori Trap or Skeet) (not shown)	1 2 30"	31" x 10½" x 3¾"	Classic Brown	142850	249.95
Traditional Two Gun Case (not shown)	2 2 34"	36" x 8¾" x 5½"	Classic Brown	142890	339.95
4 ▶ Traditional Semi-Automatic 22 Rifle Case	1 22 CALIBER	27¼" x 9" x 3¼"	Black/Tan	1428608090	224.95

SPORTER CASE



1 1 BT 1/2 0 34" 28 12x20 410

DESCRIPTION	COLOR	DIMENSIONS	CODE #	SUGG. RETAIL
Sporter Case	Black/Gold	36 3/4" x 11" x 3 3/4"	1422109408	\$199.95

SHELL - Solid wood frame with PVC-coated exterior
PADDING TYPE - High-density convoluted foam
HINGE - Full-length leather hinge
LATCH - Two combination locks
SPECIAL FEATURES - Interior tie-down straps

LEATHER/CANVAS MOTOR CASE



SHELL - Solid wood frame covered with durable cotton canvas and dark Crazy Horse distressed leather
PADDING TYPE - Plush wool interior with removable support blocks to adjust fit
HINGE - Three brass hinges
LATCH - Two brass combination locks
SPECIAL FEATURES - Shotgun stores vertically in case · Thick leather handle and leather corner caps · Accessory compartment

1 1 0 32"+ 28 12x20 410

DESCRIPTION	COLOR	DIMENSIONS	CODE #	SUGG. RETAIL
Leather/Canvas Motor Case	Olive	35" x 7 1/2" x 4 1/2"	1425204412	\$259.95

LEATHER CANVAS SERIES CASES

Brown/Brown



Charcoal/Brown



Charcoal/Brown



1 1 BT 0 34"+ 28 12x20 410

SHELL - Solid wood frame · Canvas covered · Full-grain reinforced leather trim
PADDING TYPE - Soft wool lining with movable padded support blocks
HINGE - Three solid brass hinges
LATCH - Two brass combination locks and adjustable leather straps
SPECIAL FEATURES - Embroidered Browning logo inside lid · Buckmark logo stamped on leather patch outside

DESCRIPTION	COLOR	DIMENSIONS	CODE #	SUGG. RETAIL
Leather Canvas Universal Case (Except BT-100)	Charcoal/Brown	36 3/4" x 10 1/2" x 4 3/4"	1426129408	\$319.95
Leather Canvas Universal Case (Except BT-100)	Brown/Brown	36 3/4" x 10 1/2" x 4 3/4"	1426127408	319.95

CANVAS OVER/UNDER CASE

SHELL - Solid wood frame covered with canvas
PADDING TYPE - Soft wool lining
HINGE - Three brass hinges
LATCH - Two brass combination locks
SPECIAL FEATURES - Leather corner accents · Thick leather handle · Leather Browning logo



1 1 0 32" (Except Citori XS Skeet and Trap)

DESCRIPTION	COLOR	DIMENSIONS	CODE #	SUGG. RETAIL
Canvas Over/Under Case (Except Citori XS Skeet and Trap)	Green/Olive	34 $\frac{3}{8}$ " x 9 $\frac{5}{8}$ " x 3 $\frac{11}{16}$ "	142510	\$229.95

HIGH GRADE CANVAS/CRAZY HORSE LEATHER CASE



SHELL - Solid wood frame · Canvas covered with heavy high-grade leather on borders · Handle and fastening straps
PADDING TYPE - Soft wool lining
HINGE - Three solid brass hinges
LATCH - Two solid brass combination locks
SPECIAL FEATURES - Polished brass fittings · Buckmark logo stamped on leather patches on the inside and outside · Leather trim · Accessory compartment

1 1 BT 0 34"+

DESCRIPTION	COLOR	DIMENSIONS	CODE #	SUGG. RETAIL
Universal, High-Grade Canvas/Crazy Horse Leather Trim Case	Sage/Tan	36 $\frac{7}{8}$ " x 10 $\frac{5}{8}$ " x 4"	1424504408	\$359.95

SANTA FE WAXED CANVAS WITH CRAZY HORSE LEATHER TRIM CASE



SHELL - Solid wood frame · Covered with Repel-Tex™ waxed canvas with durable Crazy Horse leather trim
PADDING TYPE - Synthetic suede interior with removable support blocks to adjust fit
HINGE - Three solid brass hinges
LATCH - Two brass combination locks
SPECIAL FEATURES - Thick leather handle and leather end caps · Buckmark logo stamped on leather patches on the inside and outside · Accessory compartment

1 1 BT 0 34"+

DESCRIPTION	COLOR	DIMENSIONS	CODE #	SUGG. RETAIL
Santa Fe Waxed Canvas with Crazy Horse Leather Trim Case	Brown	36 $\frac{7}{8}$ " x 10 $\frac{5}{8}$ " x 4 $\frac{3}{8}$ "	1429908408	\$459.95

JOHN M. BROWNING SIGNATURE LEATHER CASE

NEW

John M. Browning



1 1 BT OU 34"+ 38 12 20 440

SHELL - Solid wood frame · Top grain aniline dyed latigo leather cover with John M. Browning signature patch · Leather security straps with brass buckles
PADDING TYPE - Wool-lined interior with removable support blocks to adjust fit
HINGE - Three solid brass hinges
LATCH - Two brass combination locks
SPECIAL FEATURES - Thick leather handle and leather corner accents · Accessory compartment with magnetized choke tube holders · Leather luggage tag

DESCRIPTION	COLOR	DIMENSIONS	CODE #	SUGG. RETAIL
NEW John M. Browning Signature Leather Case	Cherry	35¼" x 9¾" x 4½"	1428786208	\$549.95

CRAZY HORSE DISTRESSED LEATHER CASE

SHELL - Solid wood frame covered with durable Crazy Horse distressed leather
PADDING TYPE - Plush wool interior with removable support blocks to adjust fit
HINGE - Full-length leather hinge
LATCH - Two brass combination locks
SPECIAL FEATURES - Thick leather handle and leather end caps · Accessory compartment with six choke tube slots



1 1 BT OU 34"+ 38 12 20 440

DESCRIPTION	COLOR	DIMENSIONS	CODE #	SUGG. RETAIL
Crazy Horse Distressed Leather Universal Case	Brown	36⅞" x 10⅞" x 4"	1424208408	\$524.95

MIRAGE CASES

Zerust®



Double Gun

Single Gun



SHELL - Copolymer material
PADDING TYPE - Double convoluted foam
HINGE - Piano-style hinges
LATCH - Four locking points
SPECIAL FEATURES - Single gun holds one scoped firearm · Oversize double case holds two scoped firearms · Airline approved · Corrosion-inhibiting Zerust® inserts

DESCRIPTION	INSIDE DIMENSIONS	WEIGHT	CODE #	SUGG. RETAIL
Double Gun	53⅝" x 16½" x 4½"	12 lbs.	1470021	\$69.95
Single Gun	53⅝" x 12¼" x 3¾"	5 lbs.	1470022	49.95

BRUISER CASES

Bruiser Gun Cases offer exceptional protection for your valuable firearms during airline travel and transportation. The high-density double wall polyethylene construction makes this case one tough "Bruiser." For added protection, foam inserts can be extended outward to keep guns separated or pushed inward if not needed.

An O-ring sealed tongue and groove lid provides excellent weather resistance. Recessed wheels offer easy mobility. Corrosion-inhibiting Zerust® inserts are added to each case to help protect your firearms from rust. Bruiser Gun Cases are offered in double gun or single takedown models.



Foam inserts protect guns from each other

Zerust insert protects all metal surfaces from rust

Recessed wheels

Purge valve



Double Gun

Single Takedown

**NEW
LOWER
PRICE
FOR 2010**

Zerust®

SHELL - Double wall high-density polyethylene with diamond plate texturing
PADDING TYPE - High-density foam with extendable foam insert barriers
HINGE - Tough Lock™
LATCH - Three locking points for padlocks
SPECIAL FEATURES - Rounded corners · Recessed handles · Purge valve · Tongue and groove lid with O-ring seal · Corrosion-inhibiting Zerust® inserts · Recessed wheels · Airline approved · Available in double gun or single takedown models

DESCRIPTION	INSIDE DIMENSIONS	WEIGHT	CODE #	SUGG. RETAIL
Double Gun	54" x 15" x 5"	24 lbs.	149002	\$199.95
Single Takedown	38" x 14" x 5"	16 lbs.	149001	139.95

TALON ALUMINUM FRAME CASES

NEW



Double Gun



Takedown

SHELL - Anodized aluminum frame · Diamond pattern ABS cover over composite panels
PADDING TYPE - High-density foam padding
 · Straps to hold firearms in place on double and takedown models
CLOSURE - Combination and key locks
SPECIAL FEATURES - Locking ammunition storage case · Wheels on double and takedown models · Embossed metal Buckmark plaque · Lightweight

Double Pistol



Ammo Case

DESCRIPTION	DIMENSIONS	WEIGHT	CODE #	SUGG. RETAIL
NEW Double Gun	53" x 16" x 5"	17 lbs.	1460079999	\$249.95
NEW Takedown	35½" x 10½" x 4"	9 lbs.	1460079512	149.95
NEW Double Pistol	13½" x 12" x 3¾"	4.3 lbs.	1460079866	69.95
NEW Ammo Case	15½" x 6" x 6"	4.7 lbs.	12100798	74.95

PLAINSMAN CASES

NEW

SHELL - 600 denier polyester canvas
 LINING - Brushed tricot
 PADDING TYPE - Open-cell foam
 CLOSURE - Zipper
 TRIM & BINDING - Polyester canvas



NEW FOR 2010
 Mossy Oak Break-Up Infinity camo is also available on select flex cases and pistol rugs.



Rifle, Mossy Oak® New Break-Up®

Shotgun, Black

Slip, Olive

NEW

DESCRIPTION	SIZE	CODE #	SUGG. RETAIL	DESCRIPTION	SIZE	CODE #	SUGG. RETAIL
NEW Black Rifle	48"	1410049248	\$27.95	NEW MONBU Rifle	48"	1410041248	\$39.95
NEW Black Shotgun	52"	1410049152	27.95	NEW MONBU Shotgun	52"	1410041152	39.95
NEW Black Slip	52"	1410049052	24.95	NEW MONBU Oversized	50"	1410041250	49.95
NEW Black Pistol Rug	13"	1430049813	14.95	NEW MONBU Slip	52"	1410041052	34.95
NEW Olive Rifle	48"	1410044248	27.95	NEW MONBU Pistol Rug	13"	1430041813	17.95
NEW Olive Shotgun	52"	1410044152	27.95	NEW MOINF Shotgun	52"	1410040152	39.95
NEW Olive Slip	52"	1410044052	24.95	NEW MOINF Rifle	48"	1410040248	39.95
NEW Olive Pistol Rug	11"	1430044811	14.95	NEW MOINF Oversized	50"	1410040250	49.95
NEW Olive Pistol Rug	13"	1430044813	14.95	NEW MOINF Slip	52"	1410040052	34.95
				NEW MOINF Pistol Rug	13"	1430040813	17.95



11" Pistol Rug, Olive

13" Pistol Rug, Mossy Oak® New Break-Up®

FLEX FOAM BUCK MARK® PISTOL CASE

SHELL - 600 denier polyester
 LINING - Laminated nylon tricot
 PADDING TYPE - EVA foam
 CLOSURE - Zipper
 COLOR - Black

TRIM & BINDING - Polyester
 · Nylon · D-rings for attaching shoulder strap (not included)
 SPECIAL FEATURES - Case has two cavities for magazines

DESCRIPTION	SIZE	CODE #	SUGG. RETAIL
Pistol Case	15"	1419001	\$49.95



CIMMARON CASES



Regular

Scoped

SHELL - 600 denier polyester canvas
 LINING - Brushed tricot
 PADDING TYPE - Open-cell foam
 CLOSURE - Zipper
 COLOR - Taupe/Black
 TRIM & BINDING - Polyester canvas
 · Outside pocket for choke tube on 52" model · Pocket with shell loops on 48" model
 MUZZLE CAP - Leather



BLR® Takedown

Pistol Rug

DESCRIPTION	SIZE	CODE #	SUGG. RETAIL
Scoped	40"	1410309240	\$39.95
Scoped	44"	1410309244	39.95
Scoped	48"	1410309248	39.95
Regular	52"	1410309152	39.95
Pistol Rug	11"	143030911	15.95
Pistol Rug	13"	143030913	15.95
BLR Takedown	—	1410309090	47.95
NEW Oversized	50"	1410309250	49.95

RIDGE CASES



Regular

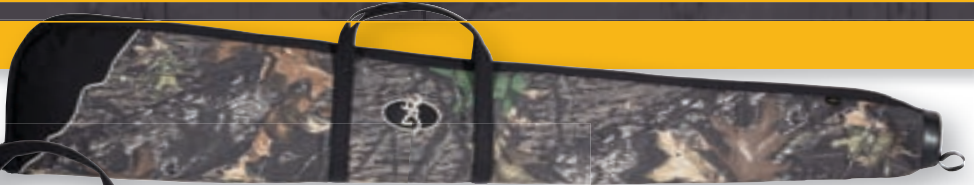

Scoped



NEW

NEW FOR 2010
Mossy Oak Break-Up Infinity camo will be available on select flex cases.

SHELL - 600 denier poly-canvas
 PADDING TYPE - Open-cell foam
 MUZZLE CAP - Rubber
 CLOSURE - Zipper
 COLOR - Mossy Oak® camo patterns
 TRIM & BINDING - Poly-canvas

DESCRIPTION	SIZE	CODE #	SUGG. RETAIL
Scoped MONBU	44"	1410371244	\$51.95
Scoped MONBU	48"	1410371248	51.95
NEW Scoped MOINF	48"	1410370248	51.95
Regular MONBU	52"	1410371152	47.95



SHERIDAN TWO-TONE CASES



Regular, Black/Mossy Oak® Duck Blind®

Scoped, Black/Mossy Oak® Break-Up®

SHELL - Polyester canvas
 LINING - Brushed tricot
 PADDING TYPE - Open cell foam
 CLOSURE - Zipper
 COLOR - Two-tone black and Mossy Oak® camo patterns
 MUZZLE CAP - Leather
 TRIM & BINDING - Polyester canvas
 · 3D Buckmark embroidery · Contrasting piping

Scoped, Black/Mossy Oak® Treestand®

DESCRIPTION	SIZE	CODE #	SUGG. RETAIL
Scoped Black/MOBU	40"	1412124240	\$49.95
Scoped Black/MOBU	44"	1412124244	49.95
Scoped Black/MOBU	48"	1412124248	49.95
Scoped Black/MOBR (not shown)	48"	1412125248	49.95
Regular Black/MODB	52"	1412127152	49.95
Scoped Black/MOTS	44"	1412128244	49.95
Scoped Black/MOTS	48"	1412128248	49.95

SANTA FE CASES



Regular

Pistol Rug

Scoped



SHELL - Waxed 10 oz. cotton canvas
 LINING - Quilted flannel
 PADDING TYPE - Cotton batting
 CLOSURE - Zipper
 COLOR - Field tan

MUZZLE CAP - Leather
 TRIM & BINDING - Crazy Horse leather
 · Adjustable leather strap · Side pocket with choke tube loops on 52" model · Shell loops on 48" model · Hook and loop closure

DESCRIPTION	SIZE	CODE #	SUGG. RETAIL
Regular	52"	1419908152	\$159.95
Scoped	48"	1419908248	169.95
Pistol Rug	11"	143990811	49.95

TALON CASE WITH BUCKMARK

NEW



SHELL - 600 denier poly canvas
 LINING - Brushed tricot
 PADDING TYPE - Open cell
 CLOSURE - Zipper
 COLOR - Black
 TRIM & BINDING - Polyester canvas · 3D Buckmark embroidery · Oversize design fits large optics and bipods · Two zipper closure pockets

DESCRIPTION	SIZE	CODE #	SUGG. RETAIL
NEW Talon Case with Buckmark, Black	50" Oversized	1410079250	\$49.95

WILD BOAR CASES

NEW



Rifle



Pistol Rug



Shotgun

SHELL - Textured synthetic pigskin with synthetic leather trim
 LINING - Brushed tricot
 PADDING TYPE - High-density closed cell
 CLOSURE - Zipper with snap tab closure
 COLOR - Green/brown
 TRIM & BINDING - Synthetic leather · Full-zip design allows case to lie flat when opened

DESCRIPTION	SIZE	CODE #	SUGG. RETAIL
NEW Wild Boar Rifle Case	48"	1411044248	\$59.95
NEW Wild Boar RMEF Rifle Case	48"	141104424R	59.95
NEW Wild Boar Shotgun Case	52"	1411044152	59.95
NEW Wild Boar Pistol Rug	13"	1431044813	19.95

BEAR RIVER FLOATER CASES

NEW

Field Tan



Mossy Oak® Duck Blind®

SHELL - 600 denier polyester
 LINING - Nylon
 PADDING TYPE - Closed-cell foam
 CLOSURE - Hook and loop flap
 TRIM & BINDING - Polyester

DESCRIPTION	SIZE	CODE #	SUGG. RETAIL
NEW Field Tan	52"	1410518052	\$29.95
MODB	52"	1410512152	37.95

VCI GUN SOCKS

Two-piece Gun Sock



VCI (Vapor Corrosion Inhibitor) Gun Sock

DESCRIPTION	SIZE	CODE #	SUGG. RETAIL
VCI Gun Sock	Two-Piece	149986	\$14.95
VCI Gun Sock	One size	149985	14.95

CLOSURE - Drawstring

The VCI (Vapor Corrosion Inhibitor) Gun Sock seals out moisture. VCI penetrates into the smallest crevices where oils cannot reach, to drive out moisture. Provides full protection by forming a vapor enclosure around firearm from muzzle to butt. The VCI Sock, when used in a gun safe or cabinet, will offer additional protection to all metal items in the enclosed ar One size fits most firearms.



GUN ACCESSORIES INDEX

BUCKMARK DECALS	139
BUCK MARK PISTOL ACCESSORIES	137
CARTRIDGE CASES	123
CHOKE TUBES	
Flush Tubes	124
Extended Tubes	125-126
Specialty Tubes	127
Wrenches	124-127
CHOKE TUBE CASES	127
CLEANING ACCESSORIES	136
COMBO PACKS: Rifleman's and Hunter's Pack	138
HEARING PROTECTION	132-133
MAGAZINES	129-131
SCOPE RINGS AND BASES	128-129
BAGS	
Shooting	116-117
Hunting	118-119
SHOOTING GLASSES	134
SIGHTS	135
SLINGS	
Synthetic Slings	120-121
Leather Slings	122-123
SNAP CAPS	127

GUN ACCESSORIES

Dependable gear is essential for a successful day at the range or in the woods. We offer a comprehensive line of high-quality, innovative hunting and shooting accessories for nearly every endeavor.

GUN ACCESSORIES

CLAYMASTER™ SERIES BAGS



1 ► CLAYMASTER SHOOTING BAG

- 600 denier nylon outer
- Padded interior for rigid shape
- Four exterior accessory pockets
- Comfortable padded handles and shoulder strap
- Interior divider
- 11" W x 9" H x 8" D

2 ► CLAYMASTER SHELL POUCH

- 600 denier nylon mesh pouch
- Large double compartment shell pouch
- Shell box holder with choke tube/shell loops
- Adjustable belt with quick-release buckle

3 ► CLAYMASTER BOX SHELL CARRIER

- Metal clip attaches to belt

4 ► CLAYMASTER EMPTY SHELL CARRIER

- Attaches to belt

DESCRIPTION	CODE #	SUGG. RETAIL
1 ► Shooting Bag	121020091	\$55.95
2 ► Shell Pouch	121020093	21.95
3 ► Box Shell Carrier	121020094	9.95
4 ► Empty Shell Carrier	121020096	11.95

CIMMARON SERIES BAGS



- 1 ▶ CIMMARON SHOOTING BAG**
- 600 denier nylon outer
 - Padded interior for rigid shape
 - Four exterior accessory pockets
 - Comfortable padded handles and shoulder strap
 - Interior divider
 - 11½" W x 10" H x 9" D

- 2 ▶ CIMMARON SHELL POUCH**
- 600 denier nylon mesh pouch
 - Large empty hull pouch
 - Shell box holder with choke tube/shell loops
 - Adjustable belt with quick-release buckle
- 3 ▶ CIMMARON SHELL BOX CARRIER**
- Metal clip attaches to belt
- 4 ▶ CIMMARON FOUR BOX SHELL CARRIER**
- Accessory pockets · Sturdy web handles

Shells not included with cases

DESCRIPTION	CODE #	SUGG. RETAIL
1 ▶ Shooting Bag	121030091	\$64.95
2 ▶ Shell Pouch	121030093	24.95
3 ▶ Shell Box Carrier	121030094	11.95
4 ▶ Four Box Carrier	121030095	15.95

SANTA FE SERIES BAGS



- 1 ▶ SANTA FE SHOOTER'S BAG**
- Constructed from 10 oz. waxed cotton canvas with Crazy Horse leather trim
 - Foam padded sides maintain bag shape
 - Large compartmentalized interior holds 16 boxes of shells and allows separation of shell gauges
 - Sturdy YKK® zippers
 - Four exterior accessory pockets
 - Comfortable padded leather shoulder strap and handles
 - Attractive brass hardware
 - 12" W x 10" H x 9" D

- 2 ▶ SANTA FE SHELL POUCH**
- Constructed from 10 oz. waxed cotton canvas with Crazy Horse leather trim
 - Large empty hull pouch
 - Shell box holder with choke tube/shell loops
 - Adjustable belt with quick-release buckle
- 3 ▶ SANTA FE SHELL BOX CARRIER**
- Constructed from 10 oz. waxed cotton canvas with Crazy Horse leather trim
 - Metal clip attaches to belt

Shells not included with cases

DESCRIPTION	CODE #	SUGG. RETAIL
1 ▶ Shooter's Bag	121040081	\$179.95
2 ▶ Shell Pouch	121040082	64.95
3 ▶ Shell Box Carrier	121040084	24.95

WILD BOAR SERIES BAGS

NEW



1 ▶ Roller Bag, Back

1 ▶ Roller Bag, Front with handle extended

- 1 ▶ WILD BOAR LARGE ROLLER SHOOTING BAG**
- Textured synthetic pigskin with synthetic leather trim
 - Padded interior for rigid shape
 - Side exterior accessory pockets
 - ABS roller bearing wheels
 - Collapsible handle zips into its own pocket
 - 16" W x 15" H x 10" D
 - Handle extends to 37½"
- 2 ▶ WILD BOAR COMPACT SHOOTING BAG**
- Textured synthetic pigskin with synthetic leather trim
 - Large divided shell compartment
 - Front exterior accessory pocket
 - Carries eight boxes of shells
- 3 ▶ WILD BOAR SHELL POUCH**
- Textured synthetic pigskin with synthetic leather trim
 - Large empty hull pouch
 - Shell box holder with choke tube/shell loops
 - Adjustable belt with quick-release buckle

DESCRIPTION	CODE #	SUGG. RETAIL
1 ▶ NEW Large Roller Shooting Bag	121104047	\$79.95
2 ▶ NEW Compact Shooting Bag	121104041	29.95
3 ▶ NEW Shell Pouch	121104042	24.95

SAWTOOTH MOUNTAIN BAGS

Sawtooth Mountain bags are built for rugged adventures. From the Ballistic Nylon and heavy-duty 900 denier poly shell fabric, to the oversized zippers, durable molded bottoms and reinforced stress points, these bags are designed to withstand the abuse of traveling to hunting camps with heavy loads. The anvil-style openings on both duffel bags provide a wide mouth to quickly pack or locate clothing, while the separate bottom compartments are perfect for separating dirty boots and other gear. The conveniently-sized Gear Bag is ideal for knives, flashlights and ammo and the zip open top makes everything fast and easy to grab. Each bag has been designed by the famed Fishpond® company to be The Best There Is®.

LARGE DUFFLE

- Anvil-style opening
- Cavernous main compartment
- Two huge side compartments
- Two pockets under buckle-down flap
- Large bottom pocket for boots or parkas
- Hidden pocket for a handgun
- Mossy Oak® New Break-Up®
- Dimensions: 26" L x 16" W x 16" D

MEDIUM DUFFLE

- Anvil style opening
- Big main compartment
- Two side pockets
- Two pockets under buckle-down flap
- Large bottom compartment for boots or a parka
- Mossy Oak® New Break-Up®
- Dimensions: 18" L x 12" W x 12" D

GEAR BAG

- Ideal for ammo, flashlights, knives and other small items
- Slick dual-entry top for quick access to ammo or gear
- Accessory pocket on the end
- Removable dividers to customize interior
- Hard molded bottom
- Mossy Oak® New Break-Up®
- Dimensions: 15" L x 7" W x 7" D



Large Duffel



Medium Duffel



Gear Bag

SAWTOOTH MOUNTAIN

DESCRIPTION	CODE #	SUGG. RETAIL
Large Duffel	121805	\$149.99
Medium Duffel	121806	119.99
Gear Bag	121804	79.99



SALT CREEK WATERFOWL BAGS

SALT CREEK
waterfowl



Large Duffle



Medium Duffle



Gear Bag



Luggage Tag

NEW

The Salt Creek meanders through some of the West's finest waterfowl marshes, so it's only fitting that the Browning waterfowl bags that bear its name are the finest on the market. As any duck hunter knows, waterfowl gear must stand up to the harshest conditions. Salt Creek bags are built out of the finest and most rugged materials like wear-resistant Ballistic Nylon and heavy-duty 900 denier poly, rust-proof pewter zipper pulls, oversized heavy-coil zippers, reinforced stitching, rigid foam liners and molded waterproof bottoms. These are just some of the construction features that make these bags the top-of-the-line gear for waterfowl hunting. Couple the durable construction with functional design and handsome aesthetics and it's hard to imagine a better built, better looking, more functional line of waterfowl bags anywhere. Designed and engineered by the famed Fishpond® company, these bags are built with the sole purpose to be the finest waterfowl bags on the market.

LARGE DUFFLE

- Cavernous main compartment
- Large outer lid pocket
- Two end pockets, one rear pocket
- Rigid lid has buckle, zippered and magnetic closures for easy access and protection from the elements
- Shotgun straps and inner and outer pocket on lid
- Hard molded polymer bottom
- Mossy Oak® Duck Blind®
- Dimensions: 25" L x 13" W x 12" D

MEDIUM DUFFLE

- Big main compartment
- Two end pockets, one rear pocket
- Rigid lid has buckle, zipper and magnetic closures for easy access and protection from the elements
- Large outer lid pockets
- Hard molded polymer bottom
- Mossy Oak® Duck Blind®
- Dimensions: 20" L x 11" W x 10" D

GEAR BAG

- Ideal for the boat or layout blind
- Top and side-entry for quick access to ammo
- Collapsible, zippered dividers separate ammo and customize interior
- External and internal openings to access end shell pockets
- One rear pocket
- Hard molded polymer bottom
- Mossy Oak® Duck Blind®
- Dimensions: 17" L x 9" W x 7" D

LUGGAGE TAG

- Durable molded rubber
- Highly visible with Buckmark logo
- Name and address card included

DESCRIPTION	CODE #	SUGG. RETAIL
Large Duffle	121905	\$199.99
Medium Duffle	121906	149.99
Gear Bag	121904	89.99
NEW Luggage Tag	12101	7.99

X-CELLERATOR PLUS™/X-CELLERATOR™ SLINGS



X-CELLERATOR PLUS SLINGS

- Padded neoprene shoulder strap
- Easy adjusting, patented slip-lock buckle
- Includes metal swivels

X-CELLERATOR SLINGS

- Easy adjusting patented slip-lock buckle
- Can be positioned as shoulder or backpack sling
- Wide range of adjustment
- Includes metal swivels
- 1¼" width

DESCRIPTION	FITS	STUD DISTANCE	CODE #	SUGG. RETAIL
X-CELLERATOR PLUS SLINGS				
NEW Digital Green	Rifles	25½" to 28"	122313425	\$39.99
Black	Rifles	25½" to 28"	122312025	39.99
Mossy Oak Break-Up	Rifles	25½" to 28"	122310125	39.99
Mossy Oak Brush	Rifles	25½" to 28"	122311625	39.99
Black	Shotguns	38" to 48"	122312035	44.99
Mossy Oak Break-Up	Shotguns	38" to 48"	122310135	44.99
Mossy Oak Duck Blind	Shotguns	38" to 48"	122313035	44.99
X-CELLERATOR PLUS SLINGS WITH CARTRIDGE LOOPS				
Black	Rifles	25½" to 28"	122302325	\$49.99
Mossy Oak Break-Up	Rifles	25½" to 28"	122310325	49.99
X-CELLERATOR SLINGS				
NEW Digital Green	Rifles	25½" to 28"	122303425	\$29.99
Black	Rifles	25½" to 28"	122302025	29.99
Tan	Rifles	25½" to 28"	122301425	29.99
Mossy Oak Break-Up	Rifles	25½" to 28"	122300125	29.99
Mossy Oak Brush	Rifles	25½" to 28"	122301625	29.99
Black	Most Pumps and Autos	29¾" to 48¼"	122302029	29.99
Mossy Oak Break-Up	Most Pumps and Autos	29¾" to 48¼"	122300129	34.99
Mossy Oak Duck Blind	Most Pumps and Autos	29¾" to 48¼"	122303035	34.99

ILLUSION™ SLING



DESCRIPTION	FITS	STUD DIST.	CODE #	SUGG. RETAIL
Illusion	Rifles & Shotguns	Adjustable	12251	\$29.99

- Comfortable 2" Mil-Spec elastic
- Wide range adjustment fits rifles and shotguns
- Easy to adjust buckle
- Includes metal swivels
- Convenient thumb hole loop

ECLIPSE™ SLINGS



- Padded neoprene shoulder strap
- Easy adjust patented buckle
- Convenient thumb loop gives arm a rest
- Tough Cordura® nylon and neoprene
- Select Black or Mossy Oak® Break-Up®
- Includes metal swivels

DESCRIPTION	FITS	STUD DIST.	CODE #	SUGG. RETAIL
Black	Rifles	25½" to 28"	122320025	\$39.99
Mossy Oak Break-Up	Rifles	25½" to 28"	122320125	39.99

CLINCHER AND CONTOUR CLINCHER SLINGS



DURA-TOUCH®
Armor Coating

CLINCHER

- Quiet Dura-Touch® Armor Coating improves grip in all conditions
- Won't slide or roll off shoulder
- Includes swivels
- Resists cracking and fading

CONTOUR CLINCHER

- Quiet Dura-Touch® Armor Coating improves grip in all conditions
- Has comfort contour fit
- Won't slide or roll off shoulder
- Includes metal sling swivels
- Resists cracking and fading

DESCRIPTION	FITS	STUD DIST.	CODE #	SUGG. RETAIL
Clincher, Black	Rifles and Shotguns	Adjustable	12240	\$34.99
Contour Clincher, Black	Rifles and Shotguns	Adjustable	122920	34.99
Contour Clincher, Green Camo	Rifles and Shotguns	Adjustable	12294009	34.99

NEOPRENE SLINGS

NEW



DESCRIPTION	FITS	STUD DIST.	CODE #	SUGG. RETAIL
NEW MONBU	Rifles	Adjustable	12201318	\$29.99
NEW MODB	Shotguns	Adjustable	12201317	29.99
NEW Black, RMEF	Rifles	Adjustable	12201319	29.99

- Shock-absorbing 6mm neoprene offers superior comfort
- Rubberized backing is textured for a positive, non-slip grip
- Ladder buckle for easy adjustment
- Metal swivels
- RMEF edition available

FLEX FOAM™ SLINGS

FLEX FOAM

- Waterproof, extra-thick molded foam provides the ultimate in comfort
- Back side is textured for a positive, non-slip grip
- Available with cartridge loops or a pocket to fit an extra magazine
- Swivels not included

SWIFTACH

- Waterproof, extra-thick molded foam provides the ultimate in comfort
- Back side is textured for a positive, non-slip grip
- Attaches under magazine cap, neoprene sleeve slips over buttstock
- Shell loops
- Quick release design

FLEX FOAM SPORTER

- Waterproof, extra-thick molded foam provides the ultimate in comfort
- Back side is textured for a positive, non-slip grip
- Includes metal sling swivels

FLEX GRIP

- Molded rubberized pad won't slip off shoulder
- Elastic webbing allows for stretch and comfort
- Adjustable length
- Back side is textured for a positive, non-slip grip
- Three cartridge loops
- Includes metal sling swivels



DESCRIPTION	FITS	STUD DIST.	CODE #	SUGG. RETAIL
Black with Cartridge Loops	Most Rifles	Adjustable	12228	\$24.99
MOBU with Cartridge Loops	Most Rifles	Adjustable	12229	24.99
Black w/ Magazine Case	Most Rifles	Adjustable	12253	39.99
Swiftach	Most Shotguns	Adjustable	122820	49.99
NEW Flex Foam Sporter	Most Rifles	Adjustable	12230	19.99
NEW Flex Grip Sling, Black	Most Rifles	Adjustable	1226799	29.99

Cartridges and magazines shown are not included with slings

HORSEHAIR SLINGS

NEW



Timber Royal Black Driftwood

- New colors and patterns
- Braided horsehair is stylish, comfortable and strong
- Features all-leather reinforcement and a thumb loop
- One size fits most rifles and shotguns
- Swivels not included

DESCRIPTION	CODE #	SUGG. RETAIL
NEW Timber	122294	\$59.99
NEW Royal	122255	59.99
NEW Black	122299	59.99
NEW Driftwood	122298	59.99

BUFFALO NICKEL, SOUTHWESTERN AND BARBED WIRE SLINGS

NEW



Buffalo Nickel

Southwestern

Barbed Wire

BUFFALO NICKEL

- Basketweave design
- Full-grain leather construction with suede backing
- Unique buffalo nickel overlays
- Braided horsehair inlay
- Swivels not included

SOUTHWESTERN

- Jacquard weave pattern in southwestern style
- Full-grain leather construction with suede backing
- Braided horsehair inlay
- Swivels not included

BARBED WIRE

- Twisted leather cord provides a barbed wire look
- Full-grain leather construction with suede backing
- Swivels not included

DESCRIPTION	CODE #	SUGG. RETAIL
NEW Buffalo Nickel	122602	\$69.99
NEW Southwestern	122603	69.99
NEW Barbed Wire	122604	69.99

LEATHER SLINGS



Latigo

Brown Western Stitch

Antique Basket Weave

Handler



NEW
RMEF Handler

- Leather western sling stitch design is sewn freehand
- Latigo is a military-style sling providing greater accuracy by bracing the rifle with a tighter fit against arm and body
- Handler slings have convenient thumb loop
- Metal swivels included with Latigo only

DESCRIPTION	CODE #	SUGG. RETAIL
Latigo Leather, Military Style (Swivels included)	12244	\$49.99
Saddle Brown, Western Stitch Leather (Leather ties included)	1225012	39.99
Antique, Basket Weave Leather	1225098	39.99
Handler Sling (Leather ties included)	12245	49.99
NEW Padded RMEF Handler Sling (Leather ties included)	12255	49.99

SANTA FE AND RIO LOBO SLINGS



- Top-grain, silicone-treated leather is padded for comfort
- Rio Lobo sling has three cartridge loops
- Leather ties are included on Santa Fe (Brown) and Rio Lobo models

- Crazy Horse sling features distressed leather and includes metal swivels
 - Swivels not included on Santa Fe (Brown) and Rio Lobo models
- Cartridges not included with slings*

DESCRIPTION	CODE #	SUGG. RETAIL
Santa Fe, Crazy Horse	122503	\$39.99
Santa Fe, Brown, Padded	12249	44.99
Rio Lobo	12260	49.99

SIX MILE SLING

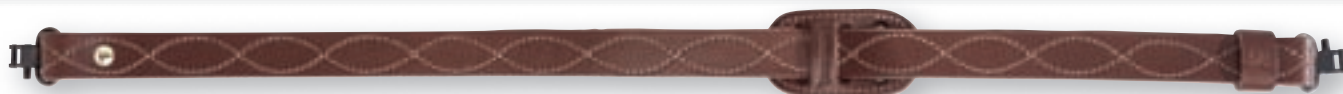

- Durable high-grade leather construction
- Classic western stitch design
- Fast, easy adjustment
- 21"-34" length adjustment
- Metal swivels included

DESCRIPTION	CODE #	SUGG. RETAIL
Six Mile Leather Sling	12243	\$29.99

CARTRIDGE CASES

1 ▶ FLEX FOAM™ CARTRIDGE CASE

- Waterproof, molded foam is lightweight and comfortable
- Holds 10 rifle cartridges
- Quiet hook closure
- Double belt loop

2 ▶ FLEX FOAM™ CARTRIDGE CARRIER

- Durable Flex Foam construction
- Triple stitched nylon-webbed belt loop or clips to hang on belt or pants
- Folding design holds 10 rifle cartridges for easy, quick access
- Hook and loop for easy, quick open/closure

3 ▶ LEATHER CARTRIDGE CASE

- Top-grain leather construction
- Folding design holds 10 rifle cartridges for easy, quick access
- Belt loop

4, 5 ▶ CRAZY HORSE LEATHER CARTRIDGE CASE

- Top-grain leather construction
- Folding design holds 10 rifle cartridges for easy, quick access
- Available in standard and magnum cartridge models
- Belt loop

6, 7 ▶ FLEX FOAM™ MAGAZINE CASE

- Lightweight Flex Foam construction
- Quiet magnetic closure
- Holds magazines for all Browning rifles
- Quick-release buckle belt loop
- Available in Black and Mossy Oak® New Break-Up®

DESCRIPTION	CAPACITY	CODE #	SUGG. RETAIL
1 ▶ Flex Foam Cartridge Case	10 rifle cartridges	12180	\$24.99
2 ▶ Flex Foam Cartridge Carrier	10 rifle cartridges	12191	29.99
3 ▶ Leather Cartridge Case	10 rifle cartridges	12195	34.99
4 ▶ Crazy Horse Leather Cartridge Case	10 rifle cartridges	12198	39.99
5 ▶ Crazy Horse Magnum Cartridge Case	10 rifle cartridges	12199	39.99
6 ▶ Flex Foam Magazine Case, Black	1 rifle magazine	12166	24.99
7 ▶ Flex Foam Magazine Case, MONBU	1 rifle magazine	12167	24.99



Cartridges and magazines shown are not included with cases

STANDARD INVECTOR™ CHOKE TUBES

- Standard Invector™ tubes are available in constrictions ranging from Cylinder to Extra-Full
- Produces excellent patterns with uniform densities
- All Browning tubes are set to industry constriction standards
- Flush fit tubes do not extend beyond end of barrel
- Constructed of highly polished, 17-4 stainless steel for the ultimate in performance and durability



Standard Invector Choke Tube



The T-Wrench allows greater leverage to be applied when tightening a tube.

DESCRIPTION	10 GA. CODE	SUGG. RETAIL	12 GA. CODE #	16 GA. CODE #	20 GA. CODE #	28 GA. CODE #	.410 BORE CODE #	SUGG. RETAIL
STANDARD INVECTOR WRENCHES, CHOKE TUBES								
T-Wrench	—	—	1130013	—	1130035	1130016	1130017	\$19.99
Wrench	1130048	\$9.99	1130048	1130048	1130048	—	—	9.99
Dual Invector Wrench	1130050	12.99	1130050	1130050	1130050	—	—	12.99
X-Full Trap Special	—	—	1130323	—	—	—	—	34.99
X-Full Turkey/Trap Spcl.	1130311	34.99	1130343	—	—	—	—	49.99
Rifled Deer Spcl. Matte	—	—	1130363	—	—	—	—	59.99
Full Choke	1130251	34.99	1130253	1130254	1130255	1130256	1130257	24.99
Improved Modified	—	—	1130263	—	—	—	—	24.99
Modified	1130271	34.99	1130273	1130274	1130275	1130276	1130277	24.99
Improved Cylinder	1130281	34.99	1130283	1130284	1130285	1130286	1130287	24.99
Skeet	—	—	1130293	1130294	1130295	1130296	1130297	24.99
Cylinder	—	—	1130303	1130304	1130305	—	—	24.99

INVECTOR-PLUS™ CHOKE TUBES



The Speed Wrench allows for quick and easy choke removal. Fits most Browning choke tubes.



The T-Wrench allows greater leverage to be applied when tightening a tube.



Invector-Plus Choke Tube

DESCRIPTION	12 GA. CODE #	20 GA. CODE #	SUGG. RETAIL
INVECTOR-PLUS WRENCHES, CHOKE TUBES			
T-Wrench	1130023	1130035	\$19.99
Speed Wrench	1130060	1130070	29.99
Wrench	1130053	—	9.99
Dual Invector Wrench	1130050	1130050	12.99
X-Full Turkey/Trap Spcl.	1130833	—	49.99
Full	1130753	1130755	29.99
Improved Modified	1130763	—	29.99
Modified	1130773	1130775	29.99
Improved Cylinder	1130783	1130785	29.99
Skeet	1130793	1130795	29.99
Cylinder	1130803	1130805	29.99

- Invector-Plus™ tubes are available in constrictions ranging from Cylinder to Extra-Full
- Longer choke taper inside Invector-Plus choke tubes for use with back-bored barrels
- Produces excellent patterns with uniform densities

- All Browning tubes are set to industry constriction standards
- Flush fit tubes do not extend beyond end of barrel
- Constructed of highly polished, 17-4 stainless steel for the ultimate in performance and durability



INVECTOR-PLUS™ EXTENDED CHOKE TUBES



- Invector-Plus™ extended tubes are constructed of highly polished, 17-4 stainless steel for the ultimate in performance and durability
- Available in constrictions ranging from Skeet to Full
- Knurled portion extends beyond the end of the barrel for easy removal and installation
- Longer choke taper inside Invector-Plus choke tubes for use with back-bored barrels
- Produces excellent patterns with uniform densities
- All Browning tubes are set to industry constriction standards

DESCRIPTION	CONSTRICTION (INCHES)	12 GA. CODE #	SUGG. RETAIL
INVECTOR-PLUS EXTENDED CHOKE TUBES			
Full	.035"	1132253	\$39.99
Improved Modified	.025"	1132263	39.99
Modified	.020"	1132273	39.99
Light Modified	.015"	1132233	39.99
Improved Cylinder	.010"	1132283	39.99
Skeet	.005"	1132293	39.99

DIAMOND GRADE CHOKE TUBES

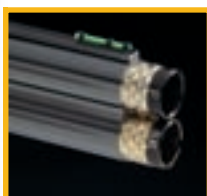

- Longer choke taper inside Invector-Plus™ choke tubes for use with back-bored barrels
- Matching tubes for the Citori 625 Sporting
- 17-4 stainless steel construction
- Absolutely perfect concentricity for superior patterning

- Diamond-cut knurling extends beyond the end of the barrel for easy removal and installation
- Titanium nitride finish with black accent band
- Browning Diamond Grade choke tubes produce tighter patterns than Browning Invector-Plus choke tubes (28 gauge and .410 bore are Standard Invector™ chokes)

DESCRIPTION	CONSTRICTION (INCHES)	12 GA. CODE #	20 GA. CODE #	28 GA. CODE #	.410 BORE CODE #	SUGG. RETAIL
Full	.035"	1134153	1135153	1136153	1137153	\$69.99
Improved Modified	.025"	1134163	1135163	1136163	1137163	69.99
Modified	.020"	1134173	1135173	1136173	1137173	69.99
Light Modified	.015"	1134133	1135133	1136133	1137133	69.99
Improved Cylinder	.010"	1134183	1135183	1136183	1137183	69.99
Skeet	.005"	1134193	1135193	1136193	1137193	69.99
Cylinder	.000"	1134113	1135113	1136113	1137113	69.99
Extended 12 Ga. Choke Tube T-Wrench	—	1130038	—	—	—	19.99

Flat choke tube wrench is not compatible with this choke tube.



DIANA™ GRADE EXTENDED CHOKE TUBES



- Longer choke taper inside Invector-Plus™ choke tubes for back-bored barrels
- Stainless steel barstock is heat treated prior to machining
- Titanium nitride surface 72HRC hardness for excellent wear and reduced plastic buildup
- Absolutely perfect concentricity for superior patterning
- Extends beyond the barrel for easy removal and installation
- Browning Diana™ Grade choke tubes produce tighter patterns than Browning Invector-Plus choke tubes. (28 gauge and .410 bore are Standard Invector™ chokes)



DESCRIPTION	CONSTRICTION (INCHES)	12 GA. CODE #	20 GA. CODE #	28 GA. CODE #	SUGG. RETAIL
Full	.035"	1130553	1131053	1132153	\$59.99
Improved Modified	.025"	1130563	1131063	1132163	59.99
Modified	.020"	1130573	1131073	1132173	59.99
Light Modified	.015"	1130533	1131033	1132133	59.99
Improved Cylinder	.010"	1130583	1131083	1132183	59.99
Skeet	.005"	1130593	1131093	1132193	59.99
Cylinder	.000"	1130513	—	—	59.99
Spreader*	—	1130503	—	—	79.99
Extended 12 Ga. Choke Tube T-Wrench	—	1130038	—	—	19.99

** Helically rifled to spin the shot charge and spread the pattern. Flat choke tube wrench is not compatible with this choke tube.*

MIDAS™ GRADE EXTENDED CHOKE TUBES

INVECTOR-Plus™



- Extends beyond the end of barrel for easy removal and installation
- Stainless steel with black oxide finish
- Laser-etched gold accent band
- Minimum gap geometry plus high-resolution "RMS" finish reduce buildup of plastics in the shotgun bore
- Invector-Plus™ long taper choke tube technology
- Browning Midas™ Grade choke tubes produce tighter patterns than Browning Invector-Plus choke tubes (28 gauge and .410 bore are Standard Invector™ chokes)
- Midas Pre-Pack includes six Midas Grade choke tubes (F, IM, M, LM, IC, SK) and a Speed Wrench in a Hard Case

NEW



DESCRIPTION	CONSTRICTION (INCHES)	12 GA. CODE #	20 GA. CODE #	28 GA. CODE #	.410 BORE CODE #	SUGG. RETAIL
Extra-Full Trap	.040"	1130123	—	—	—	\$49.99
Full	.035"	1130153	1130653	1130953	1131153	49.99
Improved Modified	.025"	1130163	1130663	1130063	1131163	49.99
Modified	.020"	1130173	1130673	1130073	1131173	49.99
Light Modified	.015"	1130133	1130633	1130033	1131133	49.99
Improved Cylinder	.010"	1130183	1130683	1130083	1131183	49.99
Skeet	.005"	1130193	1130693	1130993	1131193	49.99
Cylinder	.000"	1130113	—	—	—	49.99
Spreader*	—	1130103	—	—	—	69.99
Extended 12 Ga. Choke Tube T-Wrench	—	1130038	—	—	—	19.99
NEW Midas Pre-Pack with Hard Case and Speed Wrench (F, IM, M, LM, IC, SK)	—	1130143	—	—	—	299.99

* Helically rifled to spin the shot charge and spread the pattern. Flat choke tube wrench is not compatible with this choke tube.

GOOSE BAND CHOKE TUBES

NEW

- Unique extended design resembles a waterfowl leg band
- 17-4 stainless steel construction
- Superior patterning
- Threaded for 12 gauge Invector-Plus™ back-bored barrels only
- Produces tighter patterns than Browning Invector-Plus choke tubes
- Friction wrench is designed specifically for Goose Band choke tubes

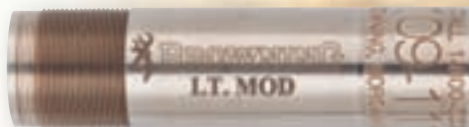

12 Gauge Friction Wrench



Goose Band Detail

DESCRIPTION	CONSTRICTION (INCHES)	12 GA. CODE #	SUGG. RETAIL
NEW Full	.035"	1131853	\$59.99
NEW Improved Modified	.025"	1131863	59.99
NEW Modified	.020"	1131873	59.99
NEW Light Modified	.015"	1131833	59.99
NEW Improved Cylinder	.010"	1131883	59.99
NEW Cylinder	.000"	1131813	59.99
NEW 12 Ga. Choke Tube Friction Wrench	—	1130080	29.99

Flat, T-Wrench, and Speed choke tube wrenches are not compatible with this choke tube.

GRAND PASSAGE™ EXTENDED CHOKE TUBES

- Mossy Oak® Duck Blind® camo band
- Stainless steel with black oxide finish
- Superior patterning
- Threaded for 12 gauge Invector-Plus™ back-bored barrels only
- Browning Grand Passage extended choke tubes produce tighter patterns than Browning Invector-Plus choke tubes
- Timber n' Teal model is helically spun to spin shot, making it excellent for tight timber, teal and close range shooting

DESCRIPTION	CONSTRICTION (INCHES)	12 GA. CODE #	SUGG. RETAIL
Full	.035"	1131453	\$49.99
Improved Modified	.025"	1131463	49.99
Modified	.020"	1131473	49.99
Light Modified	.015"	1131433	49.99
Improved Cylinder	.010"	1131483	49.99
Timber n' Teal*	—	1131493	69.99
Extended 12 Ga. Choke Tube T-Wrench	—	1130038	19.99



* Helically rifled to spin the shot charge and spread the pattern. Flat choke tube wrench is not compatible with this choke tube.

SPECIALTY EXTENDED CHOKE TUBES

FULL STRUT TURKEY TUBE

- Stainless steel with black oxide finish
- Camo band
- Directional porting
- Designed for optimal performance with #4, #5 and #6 shot
- Threaded for 12 gauge Invector-Plus™ back-bored barrels only

EXPRESS SABOT™ RIFLED CHOKE TUBE

- Stainless steel with black oxide finish
- Rifled design is extremely effective with both sabot and Foster slugs
- Threaded for 12 gauge Invector-Plus™ back-bored barrels only



DESCRIPTION	CONstriction (INCHES)	CODE #	SUGG. RETAIL
Full Strut Turkey	.102"	1130500	\$69.99
Express Sabot	—	1130863	79.99
Extended 12 Ga.	—	1130038	19.99
Choke Tube T-Wrench			

Flat choke tube wrench is not compatible with this choke tube.

CHOKE TUBE CASES

1 ▶ CORDURA® NYLON CHOKE TUBE CASE

- Rugged Cordura nylon construction
- Holds three extended choke tubes and a wrench
- Belt loop



2 ▶ FLEX FOAM™ ZIPPERED CHOKE TUBE CASE

- Molded foam with rugged nylon cover
- Holds five extended choke tubes
- Accessory pocket holds small items

3 ▶ FLEX FOAM™ CHOKE TUBE CASE

- Waterproof, molded foam is lightweight and comfortable
- Holds four extended choke tubes
- Belt loop



4 ▶ LEATHER CHOKE TUBE CASE

- Accommodates four flush choke tubes and a wrench
- Belt loop

5 ▶ CRAZY HORSE LEATHER CHOKE TUBE CASE

- Accommodates four extended choke tubes and a wrench
- Belt loop



6 ▶ HARD CASE

- Accommodates six extended choke tubes and a wrench
- Hinged lid

DESCRIPTION	CAPACITY	CODE #	SUGG. RETAIL
1 ▶ Cordura, Black	3 Invector tubes and wrench	1210120	\$19.99
2 ▶ NEW Flex Foam Zippered, Black	5 Invector tubes and pocket	1211130	29.99
3 ▶ Flex Foam, Black	4 Invector tubes and wrench	12170	24.99
4 ▶ Leather	4 Invector tubes and wrench	12163	29.99
5 ▶ Crazy Horse Leather	4 Invector tubes and wrench	12165	34.99
6 ▶ NEW Hard Case	6 Invector tubes and wrench	1211135	9.99

SNAP CAPS



- Precisely matches the dimensions of live 12 gauge shells
- A safe way to practice trigger pull
- Withstands repeated dry-firing practice
- Will not harm firing pins or chambers
- Sold in pairs



DESCRIPTION	CODE #	SUGG. RETAIL
Snap Caps — 12 Ga.	12465	\$29.99



INTEGRATED SCOPE MOUNT SYSTEM

- Integrated Scope Mounts utilize the ring and base into a single, ultra-rigid unit
- Machined from 7000 series aluminum
- Eliminates alignment problems and the possibility of a loose connection between bases and rings



DESCRIPTION	FINISH	CODE #	SUGG. RETAIL
INTEGRATED SCOPE MOUNT SYSTEM (AT LEFT)			
A-Bolt Standard Height	Gloss Finish	12390	\$49.99
A-Bolt Standard Height	Matte Finish	12391	49.99
A-Bolt Intermediate Height	Gloss Finish	12392	49.99
A-Bolt Intermediate Height	Matte Finish	12393	49.99
A-Bolt WSSM Standard Height	Matte Finish	12380	49.99
A-Bolt WSSM Intermediate Height	Matte Finish	12381	49.99
A-Bolt Mountain Ti Standard Height	Matte Finish	12382	49.99
A-Bolt Mountain Ti Intermediate Height	Matte Finish	12349	49.99
A-Bolt Mountain Ti Standard Height	Silver Finish	12387	49.99
A-Bolt Mountain Ti Intermediate Height	Silver Finish	12388	49.99
BAR, BLR Standard Height	Gloss Finish	12394	49.99
BAR, BLR Standard Height	Matte Finish	12377	49.99
BAR, BLR Intermediate Height	Gloss Finish	12395	49.99
BAR, BLR Intermediate Height	Matte Finish	12376	49.99
T-Bolt Standard Height	Matte Finish	12338	49.99

SCOPE BASES

- Browning Scope Bases are machined from solid steel
- Double recoil shoulder design holds rings securely, even under magnum recoil
- Compatible only with Browning Scope Rings below
- T-Bolt two-piece and SA-22 one-piece base designs are alloy and only compatible with Browning rimfire rings (Code 12365)
- Gold, Silver, BPS and Buck Mark bases are Weaver-type bases and are not compatible with Browning rings
- BLR Takedown bases are Weaver-type, one-piece scout-style bases for a long eye-relief scope, and are not compatible with Browning rings

DESCRIPTION	FINISH	CODE #	SUGG. RETAIL
SCOPE BASES (BELOW)			
A-Bolt (two-piece)	Matte Finish	12331	\$29.99
A-Bolt Mountain Ti (two-piece)	Matte Finish	12339	29.99
A-Bolt (two-piece)	High Lustre Finish	12330	29.99
BAR, BLR (two-piece)	High Lustre Finish	12332	29.99
BLR Takedown Short Action (one-piece)	Matte Finish	12327	69.99
BLR Takedown WSM/LA/Mag (one-piece)	Matte Finish	12326	69.99
BLR Takedown 450 Marlin (one-piece)	Matte Finish	12325	69.99
Gold/Silver/BPS 10 and 12 ga (one-piece)	Matte Finish	12360	34.99
Buck Mark (one-piece)	Matte Finish	12328	34.99
T-Bolt (two-piece)	Matte Finish	12389	29.99
SA-22 (one-piece)	Matte Finish	12333	54.99



SCOPE RINGS



DESCRIPTION	FINISH	CODE #	SUGG. RETAIL
SCOPE RINGS (AT LEFT)			
1" Standard Height — per pair	Matte Finish	12343	\$84.99
1" Intermediate Height — per pair	Matte Finish	12344	84.99
1" High Height — per pair	Matte Finish	12345	84.99
1" Standard Height — per pair	High Lustre Finish	12340	84.99
1" Intermediate Height — per pair	High Lustre Finish	12341	84.99
1" High Height — per pair	High Lustre Finish	12342	84.99
30mm Standard Height — per pair	Matte Finish	12346	84.99
30mm Intermediate Height — per pair	Matte Finish	12347	84.99
30mm High Height — per pair	Matte Finish	12348	84.99
1" Rimfire Standard Height — per pair	Matte Finish	12365	49.99

- Ultra-rigid vertically split rings use oversize hardware for extra strength and ease of installation
- Standard, Intermediate and High rings are available for both 1" and 30mm diameter scopes
- Compatible with the two-piece Scope Bases for A-Bolt, BAR, BLR shown above and the X-Lock bases for X-Bolt rifles shown on page 129

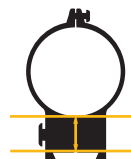

THE HEIGHT IS DETERMINED BY MEASURING FROM THE TOP OF THE BASE TO THE BOTTOM OF THE SCOPE RING.*

STANDARD (.300")

For scopes with an objective up to 44mm and a standard barrel contour

INTERMEDIATE (.400")

For scopes with an objective up to 50mm and a standard barrel contour

HIGH (.500")

For scopes with an objective up to 56mm and a standard barrel contour

* Barrel contour, optic size and preferred eye relief all affect the fit of the scope on a rifle.



X-LOCK™ MOUNTING SYSTEM SCOPE RINGS AND BASES FOR X-BOLT™ RIFLES



- Integrated Scope Mounts unitize the ring and base into a single unit
- Machined from 7000 series aluminum
- Eliminates alignment problems and loose connections between bases and rings
- Choose from integrated mounts in Standard, Intermediate and High rings
- Will accommodate both 1" and 30mm diameter scopes in gloss, matte and nickel finishes
- X-LOCK™ bases also use standard Browning rings (See page 128)

DESCRIPTION	FINISH	CODE #	SUGG. RETAIL
X-LOCK INTEGRATED 1" MOUNTS			
Matte Standard Integrated	Matte Finish	12501	\$59.99
Matte Intermediate Integrated	Matte Finish	12502	59.99
Matte High Integrated	Matte Finish	12503	59.99
Gloss Standard Integrated	Gloss Finish	12504	59.99
Gloss Intermediate Integrated	Gloss Finish	12505	59.99
Gloss High Integrated	Gloss Finish	12506	59.99
Nickel Standard Integrated	Nickel Finish	12507	59.99
Nickel Intermediate Integrated	Nickel Finish	12508	59.99
Nickel High Integrated	Nickel Finish	12509	59.99
X-LOCK INTEGRATED 30mm MOUNTS			
Matte Standard Integrated, 30mm	Matte Finish	12510	\$59.99
Matte Intermediate Integrated, 30mm	Matte Finish	12511	59.99
Matte High Integrated, 30mm	Matte Finish	12512	59.99
Gloss Standard Integrated, 30mm	Gloss Finish	12513	59.99
Gloss Intermediate Integrated, 30mm	Gloss Finish	12514	59.99
Gloss High Integrated, 30mm	Gloss Finish	12515	59.99
Nickel Standard Integrated, 30mm	Nickel Finish	12516	59.99
Nickel Intermediate Integrated, 30mm	Nickel Finish	12517	59.99
Nickel High Integrated, 30mm	Nickel Finish	12518	59.99
X-LOCK BASES (A LIST OF COMPATIBLE SCOPE RINGS CAN BE FOUND ON PAGE 128)			
Matte, Base	Matte Finish	12334	\$39.99
Gloss, Base	Gloss Finish	12362	39.99

SOLID X-LOCK™ MOUNTS

Securely mounted optics are essential to the accuracy and precision of any rifle. To ensure the X-Bolt has the most stable mount possible, it features the X-Lock scope mounting system that uses four screws per base, replacing the traditional two-screw standard. The benefits mean the scope bases are secured at all four corners rather than only held at the center of the base, and more accurate placement of the bases on the receiver. The revolutionary X-Lock system holds the base tighter to the rifle than any other system.

X-BOLT EXTRA MAGAZINES



The X-Bolt uses a detachable rotary magazine constructed from a durable lightweight polymer. The magazine is designed to feed cartridges directly in line with the bolt, instead of offset as with traditional leaf-spring magazines, for a straight path right into the chamber. An ergonomic magazine-mounted release lets the magazine rotate directly downward and into the hand. The magazine sits flush with the bottom of the rifle for a sleeker appearance. Additional magazines can be kept loaded and carried in your pocket or pack for easy, safe access.

DESCRIPTION	CODE #	SUGG. RETAIL
Long Action Magnum: 338 Win. Mag., 300 Win. Mag., 7mm Rem. Mag.	112044601	\$49.99
Long Action Standard: 30-06 Sprg., 280 Rem., 270 Win., 25-06 Rem.	112044602	49.99
Short Action Magnum: 325 WSM, 300 WSM, 7mm WSM, 270 WSM	112044603	49.99
Short Action Standard: 308 Win., 7mm-08 Rem., 243 Win.	112044604	49.99
Super Short Action Standard: 223 Rem.	112044008	49.99
Super Short Action Standard: 22-250 Rem.	112044009	49.99
Large Magnum: 375 H&H Magnum	112044606	49.99



BOSS®-CR ACCESSORY

The BOSS-CR accessory offers all the accuracy and tunable advantages of the original BOSS device without the muzzle brake feature. By simply replacing the original BOSS forward weight and recoil reduction components with the one-piece, no-hole BOSS-CR accessory, only the reduced recoil of the original BOSS is sacrificed. The BOSS-CR accessory is designed to fit only BAR Mark II and A-Bolt centerfire rifles previously factory-fitted with the BOSS.

GLOSS	MATTE	STAINLESS
BAR SAFARI AND THE FOLLOWING A-BOLT MODELS: MEDALLION GOLD MEDALLION	A-BOLT MODELS: COMPOSITE STALKER HUNTER EURO-BOLT VARMINT ECLIPSE HUNTER M-1000 ECLIPSE	A-BOLT MODELS: STAINLESS STALKER WHITE GOLD MEDALLION M-1000 ECLIPSE

CALIBER	CODE #	CODE #	CODE #
223 Rem.	1140011	1140012	1140013
223 Varmint	1140061	1140062	—
223 WSSM	1140011	1140012	1140013
243 WSSM	1140011	1140012	1140013
25 WSSM	1140011	1140012	1140013
22-250 Rem.	1140011	1140012	1140013
22-250 Varmint	1140061	1140062	—
22-250 Varmint (M1000)	—	1140062	1140063
243 Win.	1140011	1140012	1140013
7mm-08 Rem.	1140011	1140012	1140013
308 Win.	1140021	1140022	1140023
308 Varmint	1140061	1140062	—
308 Varmint (M1000)	—	1140062	1140063
25-06 Rem.	1140011	1140012	1140013
260 Rem.	1140011	1140012	1140013
270 WSM	1140021	1140022	1140023
270 Win.	1140011	1140012	1140013
280 Rem.	1140011	1140012	1140013
30-06 Sprg.	1140031	1140032	1140033
7mm WSM	1140021	1140022	1140023
7mm Rem. Mag.	1140021	1140022	1140023
300 WSM	1140041	1140042	1140043
300 WSM (M1000)	—	1140092	1140093
300 Win. Mag.	1140041	1140042	1140043
300 Win. Mag. (M1000)	—	1140092	—
325 WSM	1140051	1140052	1140053
338 Win. Mag.	1140051	1140052	1140053
375 H&H Mag.	1140071	—	1140073

It is important that the correct BOSS-CR be selected for a specific caliber and model of rifle.

MODEL	SUGG. RETAIL
BOSS-CR, matte blue	\$29.00
BOSS-CR, gloss blue	29.00
BOSS-CR, stainless	39.00



A-BOLT® EXTRA MAGAZINES

CALIBER	CODE NUMBER	SUGG. RETAIL
EXTRA MAGAZINES (ALL MODELS EXCEPT MICRO HUNTER)		
222 Rem.	112022007	\$69.99
204 Ruger	112022066	69.99
22-250 Rem.	112022009	69.99
223 Rem.	112022008	69.99
223 WSSM	112022044	69.99
223 Rem. SSA	112022060	69.99
243 Win.	112022011	69.99
243 WSSM	112022045	69.99
270 WSM	112022035	69.99
7mm-08 Rem.	112022016	69.99
7mm WSM	112022036	69.99
308 Win.	112022018	69.99
300 WSM	112022034	69.99
25 WSSM	112022049	69.99
25-06 Rem.	112022023	69.99
270 Win.	112022024	69.99
280 Rem.	112022025	69.99
30-06 Sprg.	112022026	69.99
7mm Rem. Mag.	112022027	69.99
300 Win. Mag.	112022029	69.99
300 Ultra Mag.	112022030	69.99
325 WSM	112022065	69.99
338 Win. Mag.	112022031	69.99
375 H&H Mag.	112022032	69.99
338 Ultra Mag.	112022038	69.99
EXTRA MAGAZINES (MICRO HUNTER)		
22 Hornet	112023006	\$69.99
22-250 Rem.	112023009	69.99
243 Win.	112023011	69.99
270 WSM	112023041	69.99
7mm WSM	112023042	69.99
7mm-08 Rem.	112023016	69.99
308 Win.	112023018	69.99
300 WSM	112023040	69.99
325 WSM	11202304	69.99

NOTE: Magazines that are not listed above may be available only through the Browning Parts Department at (800) 322-4626.



BLR® EXTRA MAGAZINES

CALIBER	CODE NUMBER	SUGG. RETAIL
EXTRA MAGAZINES, SHORT ACTION CALIBERS		
NEW 223 Rem.	112026008	\$69.99
243 Win.	112026011	69.99
308 Win.	112026012	69.99
22-250 Rem.	112026009	69.99
7mm-08 Rem.	112026016	69.99
270 WSM	112026030	69.99
300 WSM	112026041	69.99
7mm WSM	112026031	69.99
EXTRA MAGAZINES, LONG ACTION CALIBERS		
270 Win.	112026024	\$69.99
30-06 Sprg.	112026026	69.99
7mm Rem. Mag.	112026027	69.99
300 Win. Mag.	112026029	69.99
325 WSM	112022067	69.99
358 Win.	112026042	69.99
450 Marlin	112026043	69.99

EXTRA MAGAZINES.

It makes good sense to always carry an extra magazine in your pocket or pack for fast reloading.

BAR® EXTRA MAGAZINES

CALIBER	CODE NUMBER	SUGG. RETAIL
EXTRA MAGAZINES, BAR MARK II AND LIGHTWEIGHT STALKER		
243 Win. and 308 Win.	112025011	\$69.99
270 WSM	112025041	69.99
7mm WSM	112025042	69.99
300 WSM	112025030	69.99
EXTRA MAGAZINES, BAR LONGTRAC, BAR MARK II, SAFARI AND LIGHTWEIGHT STALKER		
270 Win., 25-06 Rem., 30-06 Sprg.	112025024	\$69.99
300 Win. Mag.	112025029	69.99
338 Win. Mag.	112025031	69.99
7mm Rem. Mag.	112025027	69.99
EXTRA MAGAZINES, BAR SHORTTRAC		
243 Win. and 308 Win.	112025050	\$69.99
7mm-08 Rem.	112025051	69.99
270 WSM	112025055	69.99
7mm WSM	112025055	69.99
300 WSM	112025055	69.99
325 WSM	112025052	69.99

DOUBLE HELIX® MAGAZINES FOR T-BOLT™ RIFLES

CALIBER	CODE NUMBER	SUGG. RETAIL
22 L.R.	112055290	\$49.99
17 HMR/22 WMR	112055291	49.99



Patent pending Double Helix® rotary box magazine · Torsion spring driven interlocking gears provide added reliability plus easy loading and unloading · 10-round capacity.



.22 Long Rifle

17 HMR/22 WMR

HI POWER EXTRA MAGAZINES

CALIBER	CODE NUMBER	SUGG. RETAIL	CALIBER	CODE NUMBER	SUGG. RETAIL
EXTRA HI POWER PISTOL MAGAZINES (10-SHOT CAPACITY)			EXTRA HI POWER MAGAZINES (13-SHOT CAPACITY)		
9mm, S.A., H.P., Standard	112050193	\$59.99	9mm, S.A., H.P., Standard	112050293	\$69.99
9mm, S.A., H.P., Pachmayr	112051193	59.99	9mm, S.A., H.P., Pachmayr	112051293	69.99
40 S&W, S.A., H.P., Standard	112050194	59.99			
40 S&W, S.A., H.P., Pachmayr	112051194	59.99			



Hi Power Magazine



Buck Mark Magazine



Buck Mark Magazine, .22 Long Rifle

BUCK MARK® PISTOL AND RIFLE EXTRA MAGAZINES

CALIBER	CODE NUMBER	SUGG. RETAIL
EXTRA BUCK MARK MAGAZINES		
22 L.R.	112055190	\$29.99

HEARING PROTECTION.

Sustained or sharp, loud sounds can damage your hearing. Rifle or shotgun blasts (impulse noises) affect the delicate nerve endings in the inner ear and are cumulative, meaning that increased damage to hearing can be sustained over a period of time. In the early days of competitive shooting, hearing protection was not worn. Shooters did not know that the sharp report or muzzle blast could affect their hearing, since it was only temporary, and any damage sustained would dissipate, given the time between shoots. Many old-time shooters now wish they had worn hearing protection during their days of active competition.

All of today's hearing protection devices come with a noise reduction rating (NRR). The higher the number, the greater amount of protection. The NRR scale runs from 0 to about 34.

Sound is measured in decibels (dB) and most commonly in A-weighted decibels (dBA) that measure sound as it is heard by the human ear. Here are some examples of decibel levels: Rainfall is about 50 dBA. A rock concert measures 120 dBA. A power lawn mower is 90 dBA, and a 22 Short cartridge report is 143.5 dBA, with a 458 Win. Mag. at 174.4 dBA. Exposure to sustained levels above 85 dBA can damage hearing. Browning offers several models of comfortable, high-quality hearing protection and strongly recommends that shooters always wear hearing protection; preferably, doubling up with earplugs in the outer ear canal and earmuffs over the ears.



BUCKMARK HEARING PROTECTOR

NEW

- Unobtrusive low-profile design
- Soft, comfortable foam ear cups
- Foldable padded headband
- NRR 34dB



COMPACT HEARING PROTECTOR

- Ultimate in lightweight comfort
- Weighs nearly 50% less than standard hearing protectors
- Can be folded for easy storage
- NRR 21dB



MIDAS™ ELECTRONIC HEARING PROTECTOR

- Sharp noises are reduced while normal speech and sounds are amplified
- On/off volume controls
- Fast reaction time: 6 milliseconds
- Operates on two AA batteries (not included)
- 100-120 hours per set of batteries with LED battery life indicator
- NRR 33dB



Runs on 2 AA Batteries

DESCRIPTION	CODE #	SUGG. RETAIL
NEW Buckmark Hearing Protector	12680	\$19.99
Compact Hearing Protector	12631	24.99
Midas Electronic Hearing Protector	12627	69.99

DELUXE HEARING PROTECTOR



- Comfortable, extra-wide padded headband
- Adjustable stainless steel wires
- NRR 22dB

DESCRIPTION	CODE #	SUGG. RETAIL
Deluxe Hearing Protector	12632	\$29.99

DUAL SHELL HEARING PROTECTOR



- One of the highest noise reduction ratings of any earmuff
- Unique dual shell design minimizes resonance
- NRR 29dB

DESCRIPTION	CODE #	SUGG. RETAIL
Dual Shell Hearing Protector	12633	\$34.99

BROWNING DUO EARPLUGS



- Insert yellow end for variable level protection, such as at outdoor ranges
- Use olive end for a constant NRR of 22dB for indoor ranges
- Selected for use by U.S. military and NATO

DESCRIPTION	CODE #	SUGG. RETAIL
Browning Duo Earplugs	12640	\$19.99

LOW PROFILE HEARING PROTECTOR



- Lightweight and compact
- Fits comfortably behind the head for use with a hat
- NRR 19dB

DESCRIPTION	CODE #	SUGG. RETAIL
Low Profile Hearing Protector	12630	\$24.99

RANGE KIT



INCLUDES:

- Shooting glasses with orange tinted polycarbonate lenses offer both eye protection and enhanced target visibility
- Soft foam earplugs provide noise reduction up to 31dB and come with a plastic storage case (shown)
- Adjustable-fit earmuffs with padded headband have a noise reduction rating of 27dB

DESCRIPTION	CODE #	SUGG. RETAIL
Range Kit	126368	\$29.99

MAXUS® POLARIZED HUNTING GLASSES

NEW

- Tri-Acetate Cellulose (TAC) polarized lenses reduce glare and minimize distortion to eliminate eye strain and improve vision
- Grilamid frame is durable and flexible for all-day comfort and feature a buoyant foam core that keeps glasses afloat to prevent loss when fishing or hunting
- Megol nose and temple pads provide a secure fit and resist slipping caused by perspiration or sunscreen



Black/Smoke Lens



Mossy Oak® Duck Blind®/Copper Lens

DESCRIPTION	CODE #	SUGG. RETAIL
NEW Maxus Glasses, Black/Smoke	12731	\$39.99
NEW Maxus Glasses, Black/Copper	12732	39.99
NEW Maxus Glasses, MODB/Smoke	12741	39.99
NEW Maxus Glasses, MODB/Copper	12742	39.99

CLAYMASTER™ SHOOTING GLASSES

- High-grade polycarbonate lenses offer 99% UV protection
- Interchangeable orange, yellow, clear, smoke and blue colored lenses included
- Fully adjustable frames include ratcheted pitch adjustment, expandable temple length and height adjustable nose pads
- Padded case and microfiber bag are included (not shown)

DESCRIPTION	CODE #	SUGG. RETAIL
Claymaster Shooting Glasses	12715	\$39.99



ACE SHOOTING GLASSES

- High-grade polycarbonate lenses offer 99% UV protection
- Interchangeable vermilion, orange and yellow colored lenses included
- Lightweight frames
- Rubberized nose and temple pads
- Microfiber bag is included (not shown)

DESCRIPTION	CODE #	SUGG. RETAIL
Ace Shooting Glasses	12717	\$29.99

BUCK MARK® SHOOTING GLASSES



- Suspended lens offers an unobstructed view, maximum protection, stylish looks and 99% UV protection
- Wrap-around polycarbonate lens offers side protection
- Frames include ratcheted pitch adjustment
- Non-slip three position adjustable nose piece
- Rugged polycarbonate frame with non-slip temples
- Microfiber bag included (not shown)
- Available with choice of clear, orange or smoke lenses

DESCRIPTION	CODE #	SUGG. RETAIL
Buck Mark Shooting Glasses, Clear	12718	\$19.99
Buck Mark Shooting Glasses, Smoke	12719	19.99
Buck Mark Shooting Glasses, Orange	12720	19.99

HIVIZ® BUCK MARK® PISTOL SIGHT



- A great performance upgrade for the Buck Mark Pistol
- Speeds target acquisition
- Fits Browning Buck Mark Plus, Camper, Standard and Micro models
- Easy single screw installation, replaces factory sight
- Includes six LitePipes, three green and three red

HIVIZ® SIGHTS. Ultra bright HiViz sights are designed to improve accuracy and speed target acquisition. Fiber optic LitePipes gather and focus light to make picking up the sight faster than ever.

DESCRIPTION	CODE #	SUGG. RETAIL
Buck Mark Pistol Sight	12875	\$39.99

HIVIZ® 4-IN-1 GAME SIGHT



- Includes both front and rear sights, making the 4-in-1 perfect for deer, turkey, waterfowl and upland hunting
- Injection-molded optical-grade resin sight construction
- Rear sight is fully adjustable for windage and elevation
- Light-gathering LitePipes make low-light shooting effortless
- Mounts easily with no gunsmithing required

DESCRIPTION	CODE #	SUGG. RETAIL
4-in-1 Game Sight	12893	\$39.99

HIVIZ® MAGNI-OPTIC AND MAGNI-SPORT SIGHTS



MAGNI-OPTIC SIGHT



MAGNI-SPORT MAGNETIC SIGHT

- Patent pending technology solves cross-eye dominance by making the sight visible only with the shooting eye, enabling you to shoot with both eyes open for improved target acquisition and better hand/eye coordination
- Improves shooters of all levels by refining shooting form, head-to-rib alignment and correct head position on the stock
- Includes one green and one red LitePipe
- Magni-Sport includes two sizes of magnetic bases to fit the rib of most shotguns and two green and two red LitePipes
- Magni-Optic includes five screw sizes, 3/56, 3x.5, 3x.6, 5/40 and 6/48 to fit most shotguns

DESCRIPTION	CODE #	SUGG. RETAIL
Magni-Optic Sight	12854	\$39.99
Magni-Sport Magnetic Sight	12870	24.99

HIVIZ® BIRD BUSTER MAGNETIC SHOTGUN SIGHTS



- All HiViz® Bird Buster magnetic sights come with four interchangeable LitePipes of different diameters for different light conditions
- Includes three sizes of magnetic bases to fit the rib on any shotgun
- Fits all Browning shotguns

DESCRIPTION	CODE #	SUGG. RETAIL
Bird Buster Sight	12859	\$19.99

HIVIZ® COMP SIGHT



- Metal base threads directly into the bead of shotguns for a more permanent sight picture
- Interchangeable LitePipes allow shooter to match light pipe diameter and color to shooting conditions
- Includes one white, four green and three red LitePipes
- Used by some of the top pro shooters in the U.S.

- Allows the shooter to know exactly where the barrel is in relation to the target
- Metal base
- Five screw sizes, 3/56, 3x.5, 3x.6, 5/40 and 6/48 to fit most shotguns
- Key and custom carrying case included (not shown)

DESCRIPTION	CODE #	SUGG. RETAIL
Comp Sight	12850	\$39.99

GUN CLEANING MAT



- The safe way to protect both firearms and furniture
- Soft, felt-like fabric won't damage firearms
- Waterproof Zorb Tech™ backing stops spills from migrating and inhibits the soak-through of cleaners
- Mat measures 16" x 54" for plenty of room while keeping small parts in their places and organized
- Washable, dryable, highly stain resistant

DESCRIPTION	DIMENSIONS	CODE #	SUGG. RETAIL
Gun Cleaning Mat	16" x 54"	12420	\$19.99

UNIVERSAL CLEANING KIT

35-piece kit is packaged in a fitted aluminum frame carry case with handle and contains two sets of solid brass cleaning rods: One for small caliber rifles and pistols (.17-.280) and one for large caliber rifles, pistols (.30 and larger) and shotguns · Ten wire brushes, .17-.45 cal. including three shotgun brushes 12 ga., 20 ga., and .410 bore · Six wool mops from .17 cal. -12 gauge · Includes six jags, two slotted patch holders, brush adaptors, one PSH handle, handle adaptor and 50 cleaning patches



DESCRIPTION	CODE #	SUGG. RETAIL
Universal Cleaning Kit	12444	\$49.99

CARBON REMOVER, BORE POLISH, SOLVENT AND DEGREASER, GUN OIL

1 ▶ STEP 1 CARBON REMOVER

- Proprietary formula quickly removes carbon build up
- Evaporates quickly
- Contains no ammonia, pH neutral
- Pinpoint applicator
- 4 oz. bottle

2 ▶ STEP 2 BORE POLISH

- Proprietary formula improves bore condition while safely removing accuracy-harming copper build up
- Removes copper, lead and powder residue
- Evaporates quickly
- Contains no ammonia, pH neutral
- Pinpoint applicator
- 4 oz. bottle

3 ▶ STEP 3 SOLVENT AND DEGREASER

- Safely removes residue from Carbon and Bore Polish cleaners
- Fast-drying solvent displaces water
- Contains no chlorine, ozone safe
- Rapidly cuts through oil and grease
- Leaves no residue
- 19 oz. aerosol can

4 ▶ STEP 4 GUN OIL

- Proprietary formula passes strict military requirements
- Low surface tension provides excellent lubrication and corrosion protection
- Contains no synthetics
- Pinpoint applicator on 2 oz. bottle
- 6 oz. aerosol can

5 ▶ PRE-PACKAGED 4-STEP GUN CLEANER

- Includes Carbon Cleaner, Bore Polish, 10 oz. Solvent Degreaser and Gun Oil



DESCRIPTION	SIZE	CODE #	SUGG. RETAIL
1 ▶ Step 1 Carbon Remover, 4 oz. Applicator	4 oz.	124023	\$9.99
2 ▶ Step 2 Bore Polish, 4 oz. Applicator	4 oz.	124024	12.99
3 ▶ Step 3 Solvent and Degreaser, 19 oz. Aerosol	19 oz.	124025	9.99
4 ▶ Step 4 Gun Oil, 2 oz. Applicator	2 oz.	124032	7.99
5 ▶ Step 4 Gun Oil, 6 oz. Aerosol	6 oz.	124040	12.99
6 ▶ Prepack 4-Step Gun Cleaner	—	123400	39.99

BUCK MARK PISTOL HOLSTERS

NEW



Buck Mark Pistol Holster

Oversized Buck Mark Pistol Holster

- Tough ballistic nylon construction
- Closed cell padding
- Fits most Buck Mark pistols
- Oversized model available will accommodate a small scope or holographic sight
- Belt loop
- Rubberized Buckmark logo

DESCRIPTION	CODE #	SUGG. RETAIL
NEW Buck Mark Holster	12902010	\$19.99
NEW Oversized Buck Mark Holster (fits small optics)	12902011	19.99

BUCK MARK MAGAZINE HOLDER

NEW



- Molded Flex Foam case with neoprene cover
- Holds two Buck Mark magazines
- Belt loop
- Rubberized Buckmark logo

DESCRIPTION	CODE #	SUGG. RETAIL
NEW Buck Mark Magazine Holder	12902020	\$19.99

BUCK MARK HOLOGRAPHIC SIGHT

NEW



Buck Mark Scope Base

- Four reticle patterns: Circle-Dot-Cross Reticle, 3 MOA Dot Reticle, Cross-Dot Reticle, Circle-Dot Reticle
- Seven-position brightness rheostat
- Field-of view: 15.7m/100m, unlimited eye relief
- Powered by one #2032 lithium battery
- Mounts to a standard Weaver-style base
- Rugged aluminum housing with matte black finish

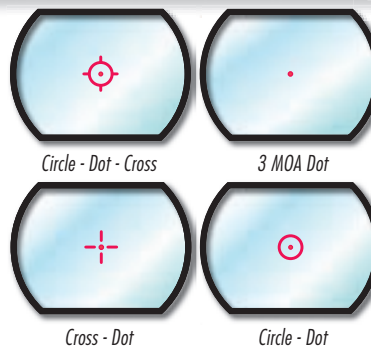

Circle - Dot - Cross

3 MOA Dot

Cross - Dot

Circle - Dot

DESCRIPTION	FINISH	CODE #	SUGG. RETAIL
NEW Buck Mark Holographic Sight	Matte Finish	1290230	\$49.99
Buck Mark Scope Base (one-piece)	Matte Finish	12328	34.99

BUCK MARK HI-VIZ® PISTOL SIGHT

- A great performance upgrade for the Buck Mark Pistol
- Speeds target acquisition
- Fits Browning Buck Mark Plus, Camper, Standard and Micro models
- Easy single screw installation, replaces factory sight
- Includes six LitePipes, three green and three red

DESCRIPTION	CODE #	SUGG. RETAIL
Buck Mark Pistol Sight	12875	\$39.99

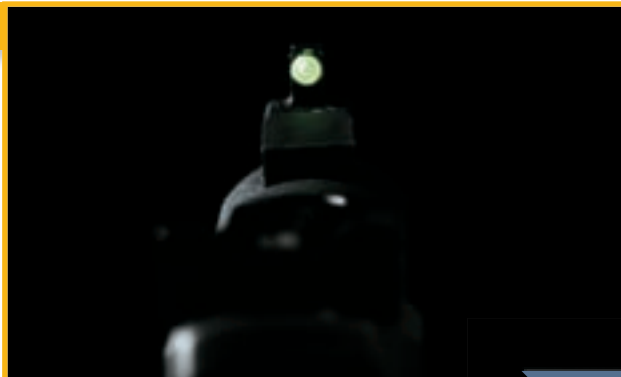



RIFLEMAN'S KIT

NEW

SPORTER SLING - Features waterproof, extra-thick molded foam for the ultimate in comfort · Back side is textured for a positive, non-slip grip · Swivels not included

TWO-PIECE NEOPRENE SCOPE COVER - Stays attached to the scope · End caps offer full protection · Fits up to 40mm scopes

NEOPRENE BUTTSTOCK COVER - Slips over buttstock · Elastic loops hold rifle cartridges · Textured molded foam recoil pad for additional comfort



Rifle, scope, mounts and cartridges not included

DESCRIPTION	CODE #	SUGG. RETAIL
NEW Rifleman's Kit	129240	\$49.99

HUNTER'S KIT

NEW

SPORTER SLING - Features waterproof, extra-thick molded foam for the ultimate in comfort · Back side is textured for a positive, non-slip grip · Swivels not included

BINOCULAR HARNESS - Keeps binoculars accessible and holds them securely on the chest to prevent bouncing · Elastic straps allow the binoculars to slide up and down the harness · Accommodates most binoculars

NEOPRENE BUTTSTOCK COVER - Slips over buttstock · Elastic loops hold rifle cartridges · Textured molded foam recoil pad for additional comfort



Rifle, scope, mounts, binoculars and cartridges not included

DESCRIPTION	CODE #	SUGG. RETAIL
NEW Hunter's Kit	129250	\$49.99





Camo Red/White/Blue Flame (3-D only) Black White Red Silver Pink Hot Pink 3-D Decals

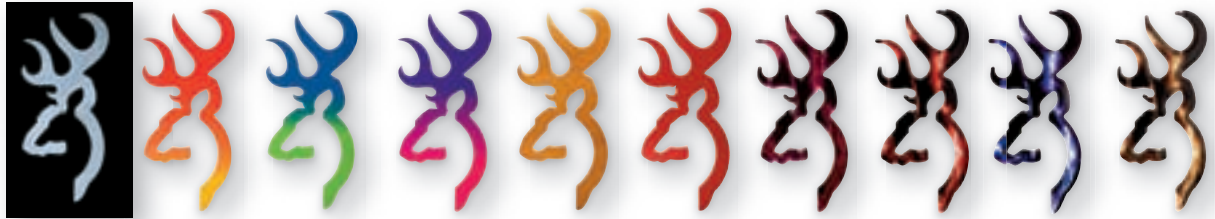

Dusted Red/Yellow Royal/Lime Purple/Pink Amber (Reflective) Red (Reflective) Black/Pink Black/Red Black/Blue Black/Gold

BUCKMARK DECALS

- High-quality vinyl resists cracking and fading
- Easy to apply and remove
- Wide variety of colors and styles
- Three sizes



Claymaster

Buckmark Decal Family • Camo/Pink



DESCRIPTION	SIZE	COLOR	CODE #	SUGG. RETAIL
-------------	------	-------	--------	--------------

FLAT DECALS

Buckmark Decal	4"	Red/White/Blue	3922003114	\$2.95
Buckmark Decal	4"	Camo	3922001914	2.95
Buckmark Decal	4"	White	3922004714	2.95
Buckmark Decal	4"	Black	3922009914	2.95
Buckmark Decal	4"	Gold	3922007314	2.95
Buckmark Decal	4"	Red	3922007114	2.95
Buckmark Decal	4"	Silver	3922005914	2.95
Buckmark Decal	6"	Red/White/Blue	3922003116	4.95
Buckmark Decal	6"	Camo	3922002916	4.95
Buckmark Decal	6"	White	3922004716	4.95
Buckmark Decal	6"	Black	3922009916	4.95
Buckmark Decal	6"	Gold	3922007316	4.95
Buckmark Decal	6"	Red	3922007116	4.95
Buckmark Decal	6"	Silver	3922005916	4.95
Buckmark Decal	6"	Pink	3922004116	4.95
Buckmark Decal	6"	Hot Pink	3922005116	4.95
Dusted Buckmark Decal	6"	Dusted	39229538	4.95
Buckmark Decal	12"	Red/Blue	3922003111	14.95
Buckmark Decal	12"	Camo	3922002911	14.95
Buckmark Decal	12"	White	3922004711	14.95
Buckmark Decal	12"	Gold	3922007311	14.95
Buckmark Decal Gradient	6"	Red/Yellow	3922050631	5.45
Buckmark Decal Gradient	6"	Royal/Lime	3922050635	5.45
Buckmark Decal Gradient	6"	Purple/Pink	3922050636	5.45
Buckmark Decal Reflective	4"	Amber	3922070442	5.45
Buckmark Decal Reflective	4"	Red	3922070461	5.45
Buckmark Decal Reflective	6"	Amber	3922070642	5.45
Buckmark Decal Reflective	6"	Red	3922070661	5.45
Buckmark Decal Family 10 pc.	Various	Camo (5)/ Pink (5)	3922100014	19.95

3-D DECALS

Buckmark Decal	6"	Red/White/Blue	3922013116	\$14.95
Buckmark Decal	6"	Camo	3922012916	14.95
Buckmark Decal	6"	Silver	3922015916	14.95
Buckmark Decal	6"	Black	3922019916	14.95
Buckmark Decal	6"	Gold	3922017316	14.95
Buckmark Decal	6"	Flame	3922019016	14.95
Claymaster Decal	3.5"	Orange	3922054	9.95
Buckmark Decal Lightning	6"	Black/Pink	3922060651	14.95
Buckmark Decal Lightning	6"	Black/Red	3922060661	14.95
Buckmark Decal Lightning	6"	Black/Blue	3922060665	14.95
Buckmark Decal Lightning	6"	Black/Gold	3922060673	14.95

KNIVES INDEX**CAMPING KNIVES**

Backcountry Camp Knife	155
Campmate Knife	158
Camp Saws	158

COLLECTIBLE KNIVES

Crowell/Barker Competition	155
Presentation Lockback	156
Scrimshaw	142
Whitetail Legacy	141

HUNTING AND FISHING KNIVES

Backtrack Folder	152
Big Game Featherweight	147
Big Game Stag	147
Browning 111 Folders	152
Escalade	144
Extreme Mountain Hunters	148
Hard Core Hunter Combos	143
Kodiak F.D.T.	151
Lil' Bit	149
Micarta Big Game Series	146
Obsession Hunting	151
Outdoorsman Fillet	145
Packer	150
Woodsmen Bird and Trout	145

KITCHEN KNIVES

Gauche Knife	157
Outdoorsman Steak Knives	157
Outdoorsman Kitchen Cutlery Set	157

POCKET KNIVES

Aztec Knife	156
Backdraft Assisted Opening	142
Chinook	156
Classic Folders	153
Eclipse Classic	153
Mountain Ti	154
Prism	154
Silvertip Folders	146

Backcountry Camp Knife, page 155

KNIVES

KNIVES — THE MOST ESSENTIAL OF GEAR

A solid knife is the most basic of tools and an essential part of your outdoor gear. From knives that are ideal for working on the ranch and dressing out a trophy buck to historic commemoratives and limited edition models that will add sparkle to any collection, we offer a wide selection of blades.

WHITETAIL LEGACY KNIVES

No deer species in North America is more respected or sought after than the whitetail. This special Whitetail Legacy Limited Edition knife honors this cagey deer and makes an excellent gift for those dedicated hunters who pursue them. The handsome handles are shaped from exquisite mesquite burl and feature finger grooves for a more secure feel. The highly polished, hollow ground fixed blade is carefully

crafted from high-quality Swedish Sandvik® steel with a tapered tang and dovetailed bolsters. A beautiful whitetail deer lithograph is included and suitable for framing. This deluxe limited edition knife includes a felt-lined, hand-crafted walnut presentation box for display. Only 3,000 of the Whitetail Legacy Limited Editions will be made. This knife is sure to be very popular, so be sure to get yours early.



Frame not included

247



WHITETAIL LEGACY LIMITED EDITION KNIFE

MODEL	DESCRIPTION	BLADE	CODE #	SUGG. RETAIL
247	Whitetail Legacy Limited Edition	3 3/4"	322247	\$250.00

SERIES FEATURES

TYPE - Fixed blade
 BLADE - Swedish Sandvik® 12C27 stainless steel
 HANDLE - Mesquite burl
 FEATURES - Limited Edition knife includes walnut presentation box and lithograph



248



249

Honoring the most popular deer in North America, Whitetail Legacy Series Knives can be relied upon to complete a variety of outdoor chores. They have been tested by Alaskan guides and Midwestern bowhunters and used for every task imaginable. The unique mesquite burl handles offer natural beauty with a warm, rich texture and exceptional durability. All blades are carefully hollow ground for a razor sharp edge and are the ideal length for field dressing game.

WHITETAIL LEGACY KNIVES

SERIES FEATURES

TYPE - Fixed blade or folding locking liner
 BLADE - Fixed blade: Swedish Sandvik® 12C27 stainless steel · Folder: 440C stainless steel
 HANDLE - Mesquite burl
 FEATURES - Fixed blade model includes a top-grain deluxe leather sheath · Folder comes with a pocket clip

MODEL	DESCRIPTION	BLADE	CODE #	SUGG. RETAIL
248	Whitetail Fixed Blade	3 3/4"	322248	\$99.95
249	Whitetail Folder	3 3/4"	322249	99.95

BACKDRAFT ASSISTED OPENING KNIVES

A sharp blade is always fast at hand with an assisted opening Backdraft Knife. These two knives feature a manual locking system that locks the blade in the closed position with no danger of inadvertently releasing the assisted opening blade. Backdraft knives feature 6061 T6 aircraft grade anodized aluminum scales, which make them look and feel rock solid. Carry a Backdraft Knife for a ready and reliable blade.



MADE IN THE USA

MODEL	DESCRIPTION	COLOR	BLADE LENGTH	CODE #	SUGG. RETAIL
355	Backdraft Assisted Opening	Silver/Blue	3 1/4"	322355	\$99.95
356	Backdraft Assisted Opening	Silver/Black	3 1/4"	322356	99.95

SERIES FEATURES

TYPE - Folding locking liner · Assisted opening

BLADES - 420 stainless steel

HANDLES - 6061 T6 aircraft grade anodized aluminum

SCRIMSHAW KNIVES



When ships with sails ruled the waves, ivory carving was a popular pastime for sailors who spent months at sea with little to do. While not cut from actual ivory, Browning Scrimshaw Knives harken back to the days of yore with finely wrought game scenes skillfully crafted into replica handles.

MODEL	DESCRIPTION	BLADE LENGTH	CODE #	SUGG. RETAIL
540	Scrimshaw Whitetail	2 7/8"	322540	\$59.95
541	Scrimshaw Mule Deer	2 7/8"	322541	59.95
542	Scrimshaw Elk	2 7/8"	322542	59.95
543	Scrimshaw Mallard	2 7/8"	322543	59.95
544	Scrimshaw Pheasant	2 7/8"	322544	59.95
545	Scrimshaw Turkey	2 7/8"	322545	59.95
547	Scrimshaw Lab	2 7/8"	322547	59.95

SERIES FEATURES

TYPE - Folding lockbacks

BLADES - Hollow ground, satin-finished Z420-J2 stainless steel
· Laser-engraved Buckmark logo

HANDLES - Finely polished zinc casting for left and balance · Laser-engraved Buckmark logo
· Adorned with scrimshaw wildlife artwork

FEATURES - Brush finished back with Browning logo

HARD CORE HUNTER COMBOS

NEW



437
Black Combo



Hard Core Hunter Series
designed by Russ Kommer



438
Mossy Oak®
New Break-Up® Combo



Hard Core Hunter — The name says it all. After years of extensive research we have the ultimate three-piece hunting set for demanding hunters. The 4¾" hand saw features a comfortable handle shape that minimizes hand fatigue. The push/pull design of the high carbon steel blade makes fast work of sawing wood or dressing game. The knife has a drop point main blade and a unique handle shape with Dura-Touch® Armor Coating for complete comfort and control. A small caping knife offers the precision for delicate field chores from caping a hide to peeling an apple. All blades fit into a slim, compact carry system with a unique swivel belt clip that makes the saw and knives easily accessible.

SERIES FEATURES

TYPE - Fixed blades

BLADES - German X50CrMoV15 steel

HANDLES - Contour-molded composite

FEATURES - Nylon sheath that easily fits all three pieces

MODEL	DESCRIPTION	BLADE LENGTH	CODE #	SUGG. RETAIL
437	NEW Hard Core Hunter Combo, Black	Drop Point: 3½" Caper: 2¾" Saw: 4¾"	322437	\$69.95
438	NEW Hard Core Hunter Combo, MONBU	Drop Point: 3½" Caper: 2¾" Saw: 4¾"	322438	79.95

ESCALADE SERIES KNIVES

Escalade Series Knives are built with rugged, edge-holding Sandvik® 12C27 or 440-C stainless steel blades in either a functional skinner type or versatile drop point style. Excellent balance and extremely functional blade shapes make quick work of field dressing and skinning game. If you prefer the warmth and beauty of wood, a fine box elder burl has been selected to perfectly offset the polished steel blade and mirror-like bolsters. If function is chosen ahead of form, models with durable Krayton® rubber handles ensure a positive grip. Fixed blades include a heavy leather sheath.

For nearly 30 years Russ Kommer has earned his living as a highly respected big game hunting guide in Idaho and the wilds of Alaska. The work of a guide doesn't end with leading clients to trophy game animals, it starts there. Once the animal is on the ground the real work begins. Over the years Russ used many knives to dress and skin countless animals, yet found each knife lacking in performance. He drew upon his wealth of hands-on experience and started designing and producing his own knives. It turns out that Russ has a knack for this art and has become a talented, award-winning knifemaker. What started as a hobby and the search for a better blade has led to numerous best-in-show awards. Russ creates and personally field tests his designs to ensure they meet the toughest standards — his own. Browning is honored to team with Russ to produce many of the knives throughout this catalog.

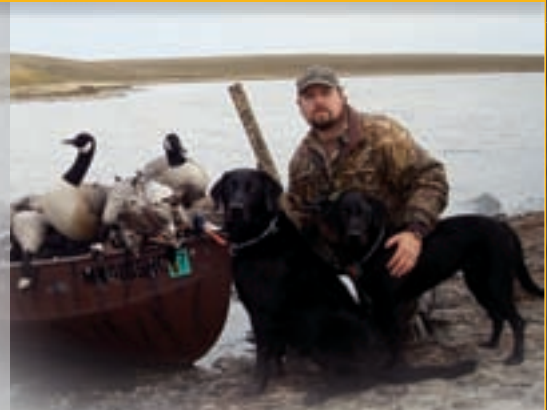

Russ Kommer

Escalade Series Knives designed by Russ Kommer



662



663



664



665



666



667



668



Each wood handle Escalade Knife comes with a heavy duty, top-grain leather sheath.



Escalade Knives with Krayton® handles include a tough Cordura® nylon sheath.

SERIES FEATURES

TYPE - Fixed, folding blades

BLADES - Swedish Sandvik® 12C27 stainless steel on fixed blades · 440-C stainless steel on folders

HANDLES - Box elder burl or Krayton® rubber

FEATURES - Wood handled fixed-blade models include a top-grain leather sheath · Krayton rubber handled models include a Cordura® nylon sheath

MODEL	DESCRIPTION	BLADE LENGTH	CODE #	SUGG. RETAIL	UNIQUE FEATURES
662	Escalade Series, Fixed Blade Skinner, Brown Box Elder Burl	2½"	322662	\$69.95	Top-grain leather sheath
663	Escalade Series, Fixed Blade Drop Point, Gray Box Elder Burl	3½"	322663	79.95	Top-grain leather sheath
664	Escalade Series, Fixed Blade Drop Point, Brown Box Elder Burl	3¼"	322664	79.95	Top-grain leather sheath
665	Escalade Series, Fixed Blade Skinner, Krayton Rubber	2½"	322665	39.95	Cordura sheath
666	Escalade Series, Fixed Blade Drop Point, Krayton Rubber	3½"	322666	49.95	Cordura sheath
667	Escalade Series, Large Folding Skinner, Brown Box Elder Burl	3"	322667	89.95	Pocket clip
668	Escalade Series, Medium Folding Skinner, Red/Black Box Elder Burl	2¾"	322668	79.95	Pocket clip

OUTDOORSMAN FILLET KNIVES

NEW

While a truly skilled individual can properly fillet a fish with a dull hatchet, most folks require the aid of a sharp, properly flexible fillet knife. The new Outdoorsman Fillet Knives fill the bill. The blade easily fillets both small and larger fish with equal ease. The razor-

sharp German X50CrMoV15 steel blade provides just the amount of flex and feedback needed to glide over bones and carve perfect fillets every time. Tough molded handles provide a non-slip grip even with a handful of wet scales.

SERIES FEATURES
TYPE - Fixed blade fillet
BLADES - German X50CrMoV15 steel
HANDLES - Durable injection molded handles with inlaid metal Buckmark
FEATURES - Nylon sheath included



MODEL	DESCRIPTION	BLADE LENGTH	CODE #	SUGG. RETAIL
483	NEW Outdoorsman Fillet Knife, Black	7¼"	322483	\$29.95
484	NEW Outdoorsman Fillet Knife, Yellow	7¼"	322484	29.95

WOODSMAN BIRD AND TROUT KNIVES



MODEL	DESCRIPTION	BLADE LENGTH	CODE #	SUGG. RETAIL
326	Woodsmen Bird and Trout, Micarta	3½"	322326	\$79.95
327	Woodsmen Bird and Trout, Micarta MODB	3½"	322327	59.95

SERIES FEATURES
TYPE - Fixed blade
BLADES - Swedish Sandvik® 12C27 stainless steel
HANDLES - 326: Micarta® black · 327: MODB camo
FEATURES - 326: Top-grain leather sheath · 327: Ballistic Cloth™ nylon sheath

The bird and trout knife is a time-tested, century-old design used by wingshooters and fishermen alike. It has endured because of the unique blade and ease of handling, enabling intricate cuts in tight places. Browning's Woodsmen Bird and Trout Knives carry on this

tradition with a choice of a Micarta® handle with mirror-polished blade or a Mossy Oak® Duck Blind® handle with satin finished blade for comfort and sure control. Sandvik® 12C27 stainless steel is used in the blade production.

SILVERTIP FOLDER SERIES KNIVES



Carrying a specially designed Silvertip folder is good thinking. This series is compact, lightweight and built tough, featuring carbon fiber or G-10 handles with blades of 440-C stainless steel. The unique blade design has an anti-skid thumb ramp and a hollow ground blade with a big belly to make fast work out of skinning game with minimal hand fatigue. Adorned with anodized colored bolsters, these are handsome knives suitable for most any skinning chore.

SERIES FEATURES

- TYPE - Folding locking liner
- BLADES - 440-C stainless steel
- HANDLES - G-10 or Carbon Fiber
- FEATURES - Locking liner · Thumbstud · Belt clip

MODEL	DESCRIPTION	BLADE LENGTH	CODE #	SUGG. RETAIL	UNIQUE FEATURES
646	Silvertip G-10 Folder	2¾"	322646	\$89.95	Type: Folding locking liner with anti-skid thumb ramp Blade: Hollow ground modified drop point
647	Silvertip Carbon-Fiber Folder	2¾"	322647	99.95	Type: Folding locking liner with anti-skid thumb ramp Blade: Hollow ground modified drop point

MICARTA® BIG GAME SERIES KNIVES

Micarta® Big Game Knives are designed with special features unlike any other. The extreme drop point and big belly, hollow ground blades are designed to prevent fatigue from creeping into hands and lower arms when skinning large big game animals such as elk and moose. The guthook design funnels the skin into the cutting edge without bunching up the hide and will make field dressing large animals without puncturing the paunch a breeze. The maintenance

free, mirror polished 440-C stainless steel blades mean there are no jobs these knives can't handle. With finger grooves for safety and comfort, rugged Micarta handles for durability, and tapered tangs for balance, these knives will easily take care of any heavy duty task requiring a sharp knife. The high-quality leather sheath features a uniquely simple lock that helps prevent the knife from falling out of the sheath.



SERIES FEATURES

- TYPE - Fixed blade
- BLADES - Drop point, 440-C stainless steel
- HANDLES - Black linen Micarta®
- FEATURES - Handsome leather sheaths (the guthook model comes with a unique locking feature)

MODEL	DESCRIPTION	BLADE LENGTH	CODE #	SUGG. RETAIL	UNIQUE FEATURES
642	Micarta Big Game, Fixed Blade	3¾"	322642	\$124.95	Type: Fixed blade Blade: Special design of extreme drop point minimizes hand fatigue during dressing, skinning
643	Micarta Big Game, Fixed Blade w/ Guthook	3¾"	322643	124.95	Type: Fixed blade Blade: Extreme drop point with guthook minimizes hand fatigue during dressing, skinning

BIG GAME STAG HUNTING KNIFE



525

When it comes to pure hunting knives, no material speaks tradition more than the warm feel of stag, which is why we offer this finely-crafted knife. In addition to the stag handle, this knife features a finely crafted blade forged from edge-holding, razor-sharp 440-A stainless steel. A high-polished bolster features a laser-etched Buckmark. Top grain leather tie and sheath included.

SERIES FEATURES

- TYPE** - Fixed blade
- BLADE** - 440-A stainless steel
- HANDLE** - Stag
- FEATURES** - Includes a top-grain leather sheath



525 with Leather Sheath

MODEL	DESCRIPTION	BLADE LENGTH	CODE #	SUGG. RETAIL	UNIQUE FEATURES
525	Stag Fixed Blade	4¼"	322525	\$119.95	Steel: 440-A Sheath: Top-grain leather Type: Fixed blade Bolster: Stainless steel

BIG GAME SERIES KNIVES

The Browning Big Game Series is one of the most popular ever for both practicality and beauty. These high-quality, three-blade models are invaluable with an edge-holding stainless steel main blade, push/pull hide cutter blade and saw blades. The 828 features laminated wood inset into durable Zytel® handles. The 524 is genuine stag. The Big Game Series has the knife you need.



SERIES FEATURES

- TYPE** - Folding lockback
- BLADES** - AUS-8A stainless steel
 - Versatile push/pull hide-cutter blade
 - Serrated saw blade
- HANDLES** - 828 has Zytel® with laminated wood inserts · 524 has stag
- FEATURES** - 828 includes Ballistic Cloth™ nylon sheath · 524 includes a top-grain leather sheath



524



828

MODEL	DESCRIPTION	BLADE LENGTH	CODE #	SUGG. RETAIL	UNIQUE FEATURES
828	Featherweight Big Game II	3¾"	322828	\$79.95	Type: Folding lockback, serrated, push/pull hide-cutter blade Sheath: Ballistic Cloth
524	Stag Big Game II	3¾"	322524	149.95	Steel: AUS-8A Sheath: Top-grain leather Type: Folding lockback (main blade only) Bolster: Brass



EXTREME MOUNTAIN HUNTERS

The next level of hunting knives is here. Extreme Mountain Hunters are designed to perform in extreme climates — from Alaskan tundra to New Mexico deserts — for those who push themselves and their gear to the limit. The handles provide a secure grip with comfortable, rounded edges and are easy to clean after dressing game. Four models include two different sized drop point blades, one with a modified

drop point and one with a deep belly, semi-skinner shape. Each blade is tough Sandvik® 12C27 stainless steel with a Rockwell hardness of 58c-59c for the edge-holding ability hunters demand. Each knife comes complete with a lightweight, injection molded sheath that complements the knives' rugged, no-nonsense construction.



465



466



467



468

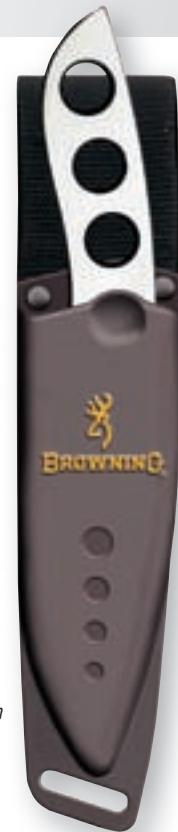

466 With Molded Sheath

Extreme Mountain Hunters designed by Russ Kommer

MODEL	DESCRIPTION	BLADE LENGTH	CODE #	SUGG. RETAIL
465	Large Drop Point	2¾"	322465	\$49.95
466	Medium Drop Point	2½"	322466	49.95
467	Modified Drop Point	2½"	322467	49.95
468	Semi-Skinner	2½"	322468	49.95

SERIES FEATURES

- TYPE** - Fixed blade extreme
- BLADES** - Teflon® coated Sandvik® 12C27 stainless steel
- HANDLES** - Stainless steel skeleton frame
- FEATURES** - Injection molded quick release sheath with Ballistic Cloth® nylon backing

LIL' BIT KNIVES

NEW

Lil' Bit Knives
designed by Russ Kommer

SERIES FEATURES

TYPE - Fixed blade and folding lockback

BLADES - Sandvik® 12C27 stainless steel

HANDLES - Genuine stag or exotic
desert ironwoodFEATURES - Top grain leather sheath
included · Leather tie

New Lil' Bit Series Knives are a tried and true drop point design with Swedish Sandvik® 12C27 stainless steel blades ensuring superior edge holding ability. Lil' Bit fixed blades are available with genuine stag or desert ironwood, a rare and beautiful exotic wood that wears like iron and has a unique grain. All of the Lil' Bit knives come with a top grain leather tie and sheath (shown at right).

MODEL	DESCRIPTION	BLADE LENGTH	CODE #	SUGG. RETAIL
790	NEW Lil' Bit Stag Small	2¾"	322790	\$49.95
791	NEW Lil' Bit Desert Ironwood Small	2¾"	322791	49.95
792	NEW Lil' Bit Stag Large	3¼"	322792	59.95
793	NEW Lil' Bit Desert Ironwood Large	3¼"	322793	59.95
794	NEW Lil' Bit Folder Stag	2⅞"	322794	44.95
795	NEW Lil' Bit Folder Desert Ironwood	2⅞"	322795	44.95

Fixed Blade
Leather Sheath

PACKER SERIES KNIVES

NEW

SERIES FEATURES

TYPE - Fixed blade

BLADES - Sandvik® 12C27 stainless steel

HANDLES - Genuine stag or highly grained burl wood

ACCESSORIES - Top-grain sheath included (stag models) · Nylon sheath included (burl)

Designed by experienced guide Russ Kommer, the new Packer Series knives were born on the rugged frontier of Alaska. The unique handle design and modified drop point blade are designed to maximize the blade cut to reduce wrist fatigue. The Packer series comes in three different blade designs: The multi-use modified drop point, the big belly semi-skinner and a modified drop point with a guthook. The knives feature genuine stag handles and a beautiful leather sheath. Browning has also teamed up with the Rocky Mountain Elk Foundation to offer knives with highly figured burl handles and a laser engraved RMEF logo on the bolsters.



Packer Series
designed by Russ Kommer

MODEL	DESCRIPTION	BLADE LENGTH	CODE #	SUGG. RETAIL
783	NEW Packer Stag	2 $\frac{7}{8}$ "	322783	\$69.95
784	NEW Packer Stag Semi Skinner	3 $\frac{1}{8}$ "	322784	69.95
785	NEW Packer Stag with Guthook	3 $\frac{1}{8}$ "	322785	69.95
780	NEW Packer RMEF Burl Wood	2 $\frac{7}{8}$ "	322780	39.95
781	NEW Packer RMEF Burl Wood Semi Skinner	3 $\frac{1}{8}$ "	322781	39.95
782	NEW Packer RMEF Burl Wood with Guthook	3 $\frac{1}{8}$ "	322782	39.95

OBSESSION SERIES KNIVES

NEW

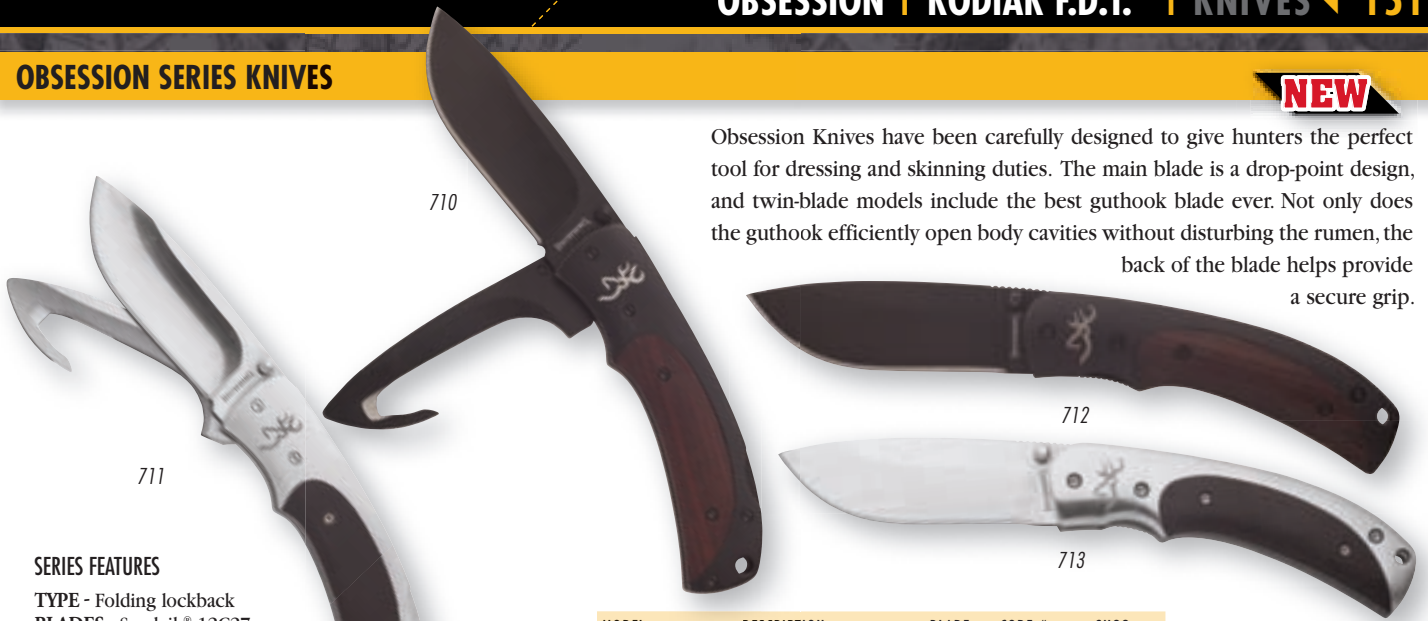

Obsession Knives have been carefully designed to give hunters the perfect tool for dressing and skinning duties. The main blade is a drop-point design, and twin-blade models include the best guthook blade ever. Not only does the guthook efficiently open body cavities without disturbing the rumen, the back of the blade helps provide a secure grip.

SERIES FEATURES

- TYPE** - Folding lockback
- BLADES** - Sandvik® 12C27 stainless steel
- HANDLES** - Stainless steel with G-10 or wood inserts
- ACCESSORIES** - Nylon sheath included (two blade models)
- Pocket clip (single blade models)

MODEL	DESCRIPTION	BLADE LENGTH	CODE #	SUGG. RETAIL
710	NEW Obsession 2-Blade Wood	3¼"	322710	\$39.95
711	NEW Obsession 2-Blade G-10	3¼"	322711	39.95
712	NEW Obsession 1-Blade Wood	3¼"	322712	29.95
713	NEW Obsession 1-Blade G-10	3¼"	322713	29.95

KODIAK F.D.T. KNIVES (FIELD DRESSING TOOLS)



The name Kodiak speaks volumes about toughness and durability, and like their namesake, these knives also know how to take game apart. These ultimate field dressing tools are available in a variety of styles with one designed to please every hunter. All feature heavy-duty Zytel® handles with non-slip rubber inlays and edge-holding AUS-8A stainless blades. Main blades open quickly with one hand and saw blades can easily be replaced.

MODEL	DESCRIPTION	BLADE LENGTH	CODE #	SUGG. RETAIL	UNIQUE FEATURES
600	Kodiak F.D.T., Black, Drop Point/Saw/Hide-Cutter	3½"	322600	\$79.95	Type: Folding lockback (all three blades lock) Blades: Drop point, saw, hide-cutter. Saw blade is replaceable
640	Kodiak F.D.T., MOBU, Drop Point/Saw/Hide-Cutter	3½"	322640	89.95	Type: Folding lockback (all three blades lock) Blades: Drop point, saw, hide-cutter. Saw blade is replaceable
645	Kodiak F.D.T., MOBU, Drop Point w/ Guthook/Saw	3½"	322645	79.95	Type: Folding lockback (both blades lock) Blades: Drop point w/ guthook and saw. Saw blade is replaceable
676	Kodiak F.D.T., Black, Drop Point/Hide-Cutter	2¾"	322676	49.95	Type: Folding lockback (both blades lock) Blades: Drop point and hide-cutter
60B	Kodiak F.D.T. Blade	3½"	32360B	17.75	Replacement saw blade for Models 600, 640, 645 (Not shown)

The push/pull hide-cutter blade reduces the risk of puncturing the rumen or other organs during field dressing.



SERIES FEATURES

- TYPE** - Folding lockback
- BLADES** - AUS-8A stainless steel
- HANDLES** - Impact-resistant Zytel® with checkered rubber inlays
- ACCESSORIES** - Ballistic Cloth™ nylon sheath included (not shown)

BROWNING 111 FOLDING KNIVES

The Buck stops here! Designed by Russ Kommer, new Browning 111 lockbacks improve upon a popular folding design. The grooved handles are constructed from rugged G-10 or walnut and contoured for a comfortable grip. The bolsters add to the beauty and balance. Modern materials and design ensure the Model 111 knives are one up on the competition.



NEW

Browning 111 Knives designed by Russ Kommer

SERIES FEATURES

TYPE - Folding lockback
BLADES - Sandvik® 12C27 stainless steel
HANDLES - 111D has G-10 scales · 111C has walnut scales
FEATURES - Ultra-thin construction slides easily into pocket without adding excess bulk · Unique blade etching with Buckmark sets these blades apart · Nylon sheath included (not shown)

MODEL	DESCRIPTION	BLADE LENGTH	CODE #	SUGG. RETAIL
111D	NEW Black G-10	3¼"	322111D	\$34.95
111C	NEW Walnut	3¼"	322111C	39.95

BACKTRACK FOLDERS

NEW

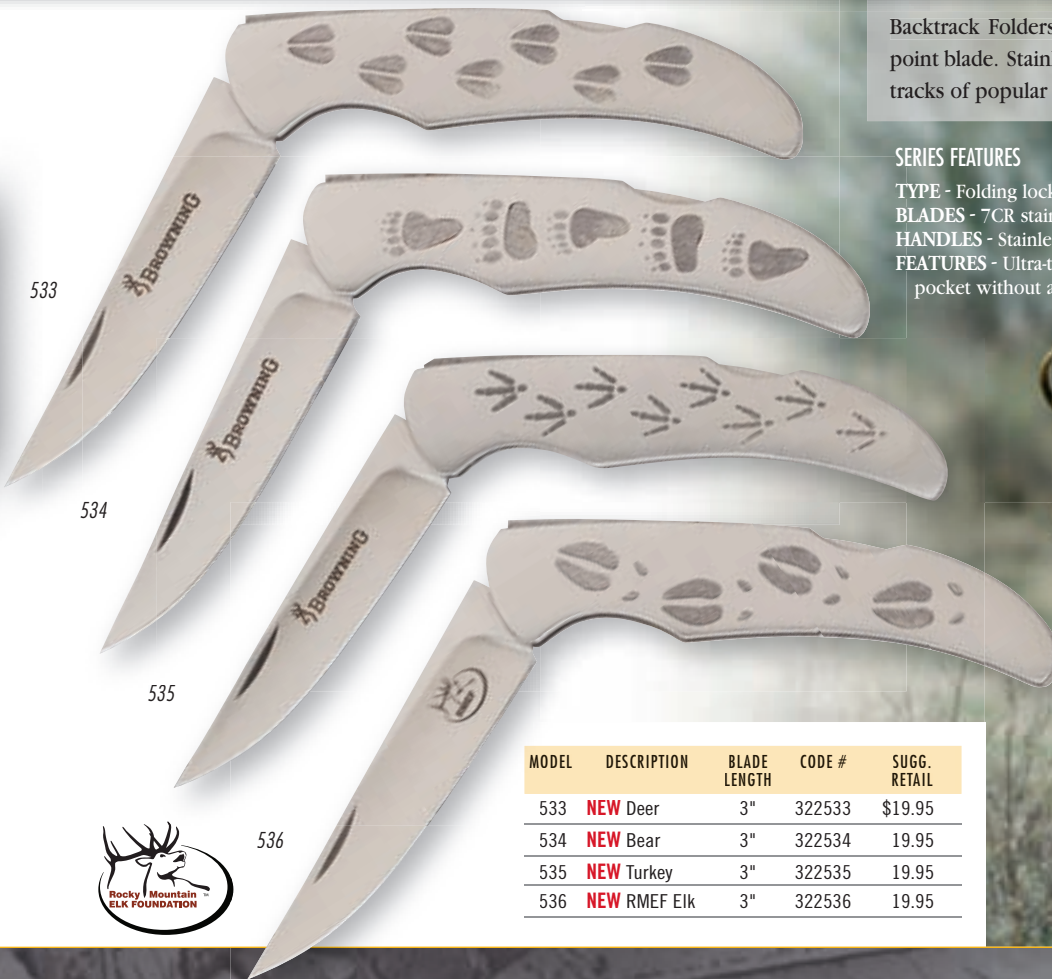

Backtrack Folders feature a versatile stainless steel clip point blade. Stainless steel handles are engraved with the tracks of popular game animals.

SERIES FEATURES

TYPE - Folding lockback
BLADES - 7CR stainless steel
HANDLES - Stainless steel with game track engraving
FEATURES - Ultra-thin construction slides easily into pocket without adding excess bulk

MODEL	DESCRIPTION	BLADE LENGTH	CODE #	SUGG. RETAIL
533	NEW Deer	3"	322533	\$19.95
534	NEW Bear	3"	322534	19.95
535	NEW Turkey	3"	322535	19.95
536	NEW RMEF Elk	3"	322536	19.95

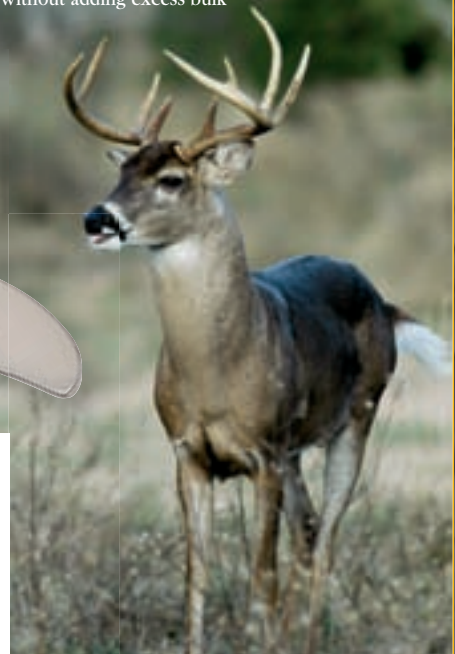

CLASSIC FOLDER KNIVES

High quality knives similar to the Classic Folder Series first appeared in the 1969 Browning catalog. The Classic Folders include all the features and more that made the originals so popular, including fancy scroll etching on the handy single blade embellished with a gold Buckmark. Each blade locks open with a snap. Thin enough to hardly notice in a pocket or purse, they make excellent gifts. Select from a variety of handle materials including stainless, wood, stag or mother-of-pearl scales.



Shown actual size

SERIES FEATURES

TYPE - Folding locking liner

BLADES - 3CR13 stainless steel with engraving

HANDLES - Stainless, Wood, Stag or Mother-of-Pearl

FEATURES - Ultra-thin construction slides easily into pocket without adding excess bulk · Unique blade etching with Buckmark sets these knives apart

MODEL	DESCRIPTION	BLADE LENGTH	CODE #	SUGG. RETAIL
334	Stainless	1¾"	322334	\$14.95
335	Wood	1¾"	322335	14.95
336	Stag	1¾"	322336	19.95
337	Mother-of-Pearl	1¾"	322337	19.95

ECLIPSE CLASSIC SERIES KNIVES

The Eclipse Classic Series features stylish handles carved from rich wood or traditional stag. These liner-lock knives open smoothly with one hand to reveal a sleek modified drop point blade with a corrosion-resistant Teflon® coating. The signature of John M. Browning is laser etched into the blade. A top-grain leather sheath is included (not shown).



SERIES FEATURES

TYPE - Folding locking liner

BLADES - 3½" Scratch-resistant Teflon® coated 440-C stainless steel · Laser engraved signature

HANDLES - Olive wood or genuine stag

FEATURES - Leather sheath included

MODEL	DESCRIPTION	BLADE LENGTH	CODE #	SUGG. RETAIL	UNIQUE FEATURES
91	Olive Wood	3½"	322091	\$89.95	Handle: Olive
92	Stag	3½"	322092	99.95	Handle: European stag

PRISM KNIVES



There is no reason to own a boring knife. Lightweight Prism folders open easily with one hand to reveal a razor-sharp drop point blade. Colorful anodized handles with laser-cut Buckmarks are durable and look great.

SERIES FEATURES

- TYPE - Folding frame lock
- BLADES - 440-A stainless steel
- HANDLES - Machined 420II stainless · Two-tone anodized
- FEATURES - Pocket clip
· Ambidextrous thumbstud

MODEL	DESCRIPTION	BLADE LENGTH	CODE #	SUGG. RETAIL
562	Pink Prism	2¼"	322562	\$14.95
563	Orange Prism	2¼"	322563	14.95
564	Blue Prism	2¼"	322564	14.95
565	Green Prism	2¼"	322565	14.95
566	Turquoise Prism	2¼"	322566	14.95

MOUNTAIN Ti KNIVES



SERIES FEATURES

- TYPE - Folding frame lock
- BLADES - 440-A stainless steel · Titanium coated
- HANDLES - Two-tone gray machined 420II stainless · Titanium coated
- FEATURES - Pocket clip
· Ambidextrous thumbstud

Lightweight and rugged, Mountain Ti Knives feature a razor-sharp, highly versatile drop point style folding blade design. The contrasting finish on the stainless steel handles is striking, while the titanium-coating on the blade adds to corrosion resistance. Easy one-hand opening puts the knife quickly into action. The frame lock offers excellent security.

MODEL	DESCRIPTION	BLADE LENGTH	CODE #	SUGG. RETAIL
560	Mountain Ti, Medium	3"	322560	\$19.95
561	Mountain Ti, Small	2¼"	322561	14.95

BACKCOUNTRY CAMP KNIFE

NEW

A solid camp knife can take care of the chores of several knives. Whether it's chopping limbs for a fire, clearing brush to make space for a tent, cleaning a trout or dressing a grouse, our new Backcountry Camp Knife is a handy addition to your pack.



SERIES FEATURES

- TYPE - Fixed blade
- BLADE - Sandvik® 12C27 stainless steel
- HANDLE - Brown linen Micarta®
- FEATURES - Top-grain leather sheath
· Sharpening stone

Leather sheath with sharpening stone

MODEL	DESCRIPTION	BLADE	CODE #	SUGG. RETAIL
975	NEW Backcountry Camp Knife	6¼"	322975	\$109.95

CROWELL/BARKER COMPETITION KNIFE



James Crowell

This unique knife is a joint design effort between James Crowell and Reggie Barker, the only two men to have won an American Bladesmith Society (ABS) World Cutting Championship. Jim Crowell is well known in the knife industry and the first to win the ABS World Championship. Reggie Barker is known as "The Sharpest Man in Texas," and won the ABS World Champion title for the third time at the 2007 BLADE Show. He's also won the 2004 and 2005 ABS World Championship Cutting Competition. The Browning Crowell/Barker Competition Knife includes a top-grain leather sheath and a Certificate of Authenticity, signed by both Jim Crowell and Reggie Barker.



Reggie Barker

This knife is approved for select International Cutting Competition Trail (ICCT) events. To learn more about this exciting new action sport, visit cuttingcompetition.com.



- TYPE - Fixed blade competition
- BLADE - Heavy drop point, made from high-carbon steel with a .142 satin finish · Laser-etched on one side
- HANDLE - Micarta® laminate with three rivets and wrist lanyard
- FEATURES - Custom-made top-grain leather sheath



Master Bladesmiths are trained professionals. Caution should be heeded when using sharp objects. Browning assumes no responsibility for misuse of its products.

MODEL	DESCRIPTION	BLADE	CODE #	SUGG. RETAIL
580	Crowell/Barker Comp.	10"	322580	\$149.95

AZTEC POCKET KNIVES

SERIES FEATURES

TYPE - Folding pocket knives
BLADES - 420 stainless steel
HANDLES - Zebra wood with stag and Buckmark inlay



MODEL	DESCRIPTION	BLADE LENGTH	CODE #	SUGG. RETAIL
215	Aztec Congress	2"	322215	\$34.95
216	Aztec Trapper	3½"	322216	34.95
217	Aztec Stockman	2¾"	322217	29.95

Aztec Pocket Knives put a twist on tradition by combining two favorite handle materials, wood and stag. The unique grain of zebra wood perfectly complements the traditional stag and Buckmark medallion.

PRESENTATION LOCKBACK KNIVES

A Browning Presentation Lockback Knife makes the perfect gift. A variety of handle materials ensures there is a knife that suits every taste. All feature a high-quality stainless steel blade, excellent fit and finish and satin-finished bolsters with a polished stripe. Presentation Lockbacks are ideal for having names, initials or company logos engraved on the bolsters.



MODEL	DESCRIPTION	BLADE LENGTH	CODE #	SUGG. RETAIL	UNIQUE FEATURES
305	Cocobolo, Lockback	2¾"	322305	\$39.95	Handle: Cocobolo
306	Quince, Lockback	2¾"	322306	49.95	Handle: Quince
307	Stag, Lockback	2¾"	322307	69.95	Handle: Stag
316	Stainless, Lockback	2¾"	322316	39.95	Handle: Stainless steel

SERIES FEATURES

TYPE - Folding lockback
BLADES - AUS-8A stainless steel
HANDLES - Cocobolo, quince, stag or stainless steel
FEATURES - Presentation case with gold Browning logo

CHINOOK KNIVES



Versatile, rugged and razor sharp, Chinook Knives are designed to be clipped to a pocket or belt so they are always at the ready. The handle shape comfortably fits in your hand and the contrasting finish on the handle and bolster offers lasting good looks. The liner lock adds excellent security and is easy to operate with your thumb.

MODEL	DESCRIPTION	BLADE LENGTH	CODE #	SUGG. RETAIL
590	Chinook, Charcoal	2¾"	322590	\$39.95
591	Chinook, Titanium	2¾"	322591	39.95



SERIES FEATURES

TYPE - Folding liner lock
BLADES - 440-A stainless steel, 590 is half-serrated
HANDLES - 590: Aluminum handle with titanium electroplated steel bolster · 591: Titanium electroplated steel handle with aluminum bolster
FEATURES - Pocket clip · Thumbstud · Available only from Browning Full Line and Medallion Dealers

OUTDOORSMAN STEAK KNIVES AND KITCHEN CUTLERY SET

Nothing is used more in the kitchen than a good set of sharp knives. Kitchen knives must be durable, have a variety of blade shapes for specific tasks and remain sharp, especially when used for processing wild game. The 14-piece Outdoorsman Kitchen Cutlery set has everything necessary for the home, cabin or camp, including a hollow-ground boning knife that holds a razor edge, game shears and a sharpening steel. The set also includes standard kitchen cutlery and a uniquely designed carving fork with a pigtail twist so it won't bend when taking a 10-pound roast from the pan. The set has a standard chef's knife with an innovative scalloped blade to reduce friction for carving meat, and six elegant steak knives for table use. Another favorite will be the bread knife, with large serrations, to make slicing warm homemade bread easy. The knives are made from quality German steel to ensure the Outdoorsman Set will last. A metal Browning Buckmark is set in the durable injection molded handles.

Part of the enjoyment of cutting into a hot, juicy steak is doing so slowly with a sharp, well-balanced steak knife. Being a savored ritual, fine dining cannot be appreciated without sharp table knives. The Outdoorsman Steak Knife set is one worthy of display and complements every dining experience. Imagine this set as elegant wedding or anniversary gift. The set includes a sleek black wood storage block enhanced with the Buckmark logo.



480

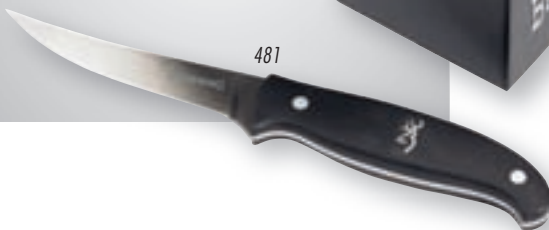

481

SERIES FEATURES

TYPE - Steak knives/Kitchen cutlery
BLADES - German X50CrMoV15 steel
HANDLES - Durable injection molded handles with inlaid metal Buckmark



MODEL	DESCRIPTION	BLADE LENGTH	CODE #	SUGG. RETAIL
480	Kitchen Cutlery Set	N/A	322480	\$324.95
481	Six Steak Knife Set	4 3/4"	322481	139.95

GAUCHO KNIFE



495

SERIES FEATURES

TYPE - Fixed blade
BLADE - 440-A stainless steel · Drop point blade design
HANDLE - Ebony with stag
FEATURES - Leather sheath

MODEL	DESCRIPTION	BLADE LENGTH	CODE #	SUGG. RETAIL
495	Gaicho Knife	4 3/4"	322495	\$29.95

A good steak is tough to beat, but never tough to cut with a Gaicho knife. This top-quality knife features an attractive combination of ebony and stag that lends a high degree of elegance. The unique sheath is designed to fit between the belt and the pants, with the flap on the sheath over the belt to prevent the knife from slipping.

CAMPMATE KNIFE

NEW

SERIES FEATURES

- TYPE - Folding with liner lock knife
- BLADES - AUS-8A stainless steel
- HANDLES - Injection-molded composite
- FEATURES - Nylon sheath included



971



970

MODEL	DESCRIPTION	CODE #	SUGG. RETAIL
970	NEW Campmate Knife, Black	322970	\$19.95
971	NEW Campmate Knife, MONBU	322971	24.95

CAMP SAWS

NEW



922

924



923

925

Camp Saws designed by Russ Kommer

There are many folding camp saws on the market, but none can match a Browning. The rubber handle is grooved and has a large tail radius to ensure a rock solid grip and comfort in your hand. The high-carbon stainless steel push/pull blade maximizes cutting efficiency on both wood and when dressing game. The unique sheath can be worn in both horizontal and vertical positions. Compact, lightweight and durable, this saw is the ultimate at a price that can't be beat. The Camp Saw Combos include a folding knife with a secure liner lock and thumbstud.

MODEL	DESCRIPTION	CODE #	SUGG. RETAIL
922	NEW Camp Saw (5¾" blade), Black	322922	\$19.95
924	NEW Camp Saw (5¾" blade) and Knife (3½" blade), Black	322923	29.95
923	NEW Camp Saw (5¾" blade), MONBU	322924	29.95
925	NEW Camp Saw (5¾" blade) and Knife (3½" blade), MONBU	322925	39.95

SERIES FEATURES

- TYPE - Folding saw and folding saw/knife combo
- BLADES - 4116 stainless steel saw · 7CR stainless steel knife
- HANDLES - Saw: Injection molded composite with rubber inlay · Knife: Anodized aluminum
- FEATURES - Nylon sheath included with saw · Knife includes pocket clip

LIGHTS

HOW TO CHOOSE A FLASHLIGHT

Browning is a leading manufacturer of portable battery-powered lighting. For 2010, there are over 50 different styles. So, how do you choose the light that best meets your individual needs?

SIZE, WEIGHT AND POWER

Smaller and lighter is better. New high-output LEDs from manufacturers like Luxeon® and Cree® are incredibly powerful and efficient, and don't require the size and weight of the old C and D battery lights to achieve the same output. Our Alpha and Alpha Max flashlights, with a single AA battery, are brighter than the flashlights of the past and are no bigger than a shotgun shell.

LED VS. XENON BULBS

LEDs are now preferred over Xenon and other types of filament bulbs for most uses. LEDs use batteries more efficiently, illuminate at equal distance, emit a clean white versus a dull yellow beam and will not burn out under normal use. LEDs are also nearly unbreakable.

HAND-HELD OR HANDS-FREE

Headlamps and cap lights allow the use of both hands for other tasks like dressing a deer, fixing the truck or finding a path through the woods. With modern technology many headlamps are as powerful as a larger hand-held flashlight. Several Browning headlamps, such as MicroBlast, Phantom, and Summit, can be worn either as a headlamp or clipped to the brim of a hat.

BATTERIES

Lithium batteries are used in many of our highest-performing lights, such as the Catalyst, Hunt Master and Nitro. Lithium batteries pack about twice the power of alkaline batteries for their weight, and operate at very cold temperatures. Convenient AA and AAA alkaline batteries are also used extensively because they cost less than lithium and are more readily available. The latest integrated circuit designs in our Hi Power, Zeta and Alpha Max flashlights boost the performance of alkaline batteries to approach the performance of lithium batteries.

SWITCH SETTINGS

Single-action switches (on/off) are preferred for self-defense and tactical applications. Multiple switch settings (high, low and in-between) preserve battery life and allow selecting between colors and flashing options. Lock-out switches on all Tactical Hunter lights keep the light from accidentally turning on.

RED, GREEN AND BLUE

Colored LEDs help preserve night vision, are great for map reading and are less obvious than white light to many types of game animals when walking to a tree stand in the dark.

LIGHTS INDEX

ACCESSORIES	171-172
FLASHLIGHTS	
Alpha and Alpha Max	162
Black Ice	166
Catalyst	163
Hi Power	160
Hunt Master	163
MicroBlast	164
Pro Hunter	165
Spitfire	165
Tactical Hunter	161
TNT	163
Zeta	162
HEADLAMPS/CAPLIGHTS	
Dakota Headlamps	170
MicroBlast Headlamp	164
Night Seeker Cap Lights	167
Night Seeker Pro Cap Lights	167
Knife/Light Combos	168
Nitro Headlamp	162
Phantom Headlamps	170
Renegade Headlamps	169
Summit Headlamps	169
KEYCHAIN LIGHTS	
Black Ice	170
Duck Call Lanyard Light	168
Echo	171
LANTERNS	171
PEN LIGHTS	164

BROWNING ENDORSES ANSI FL-1 PERFORMANCE STANDARDS

Beginning in 2010, many top flashlight manufacturers have agreed to use the same standards (ANSI-FL1) for measuring performance, so you can make an apples-to-apples comparison between models. We are proud to endorse and participate in these new standards for portable lighting.*



Lumens = Brightness. A traditional 2D flashlight is approximately 15 - 20 lumens.



Battery Life (Run Time) is defined as the time elapsed when the batteries are new to when the light reaches 10% of the original brightness.

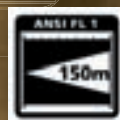

Maximum Distance is measured as the distance in meters from the light to where it decreases in brightness to 0.25 lux — about the brightness of the full moon on a clear night.

* For Browning lights with multiple settings, the Lumens, Battery Life, and Distance are stated in the specifications at the highest setting (100% power), unless indicated otherwise.

HI POWER FLASHLIGHTS

NEW

With fantastic new looks and the ability to squeeze every last drop of energy from a pair of AA alkaline batteries, the powerful new Hi Power Flashlights blend innovative technology with a striking appearance. Hi Power Flashlights feature the very latest circuitry to provide the brightest AA-powered LED flashlight available. Protecting this leading-edge technology is a precision-machined aluminum housing available with

tough resin inlays or the same American walnut used for our firearms set into the grip for a great new look. The push-button switch is fast, easy to operate and includes a lock-out to keep the switch from accidentally turning on. One thing is for certain, when it comes to looks, battery life and sheer light output the new Hi Power light is sure to be the first light you reach for.

- All-aluminum construction with walnut or black resin handle inlays
- Latest generation Cree® XPE LED is rated for 50,000 hours use
- High-low electronic switch with lock-out
- O-ring sealed for water-resistance
- Includes lanyard and two AA batteries
- Length: 5.25"
- Brightness: 145 lumens
- Effective distance: 150 meters



5303, Matte Silver with Walnut

5304, Desert Metallic with Black

5302, Mossy Oak® New Break-Up® with Black

5301, Black with Walnut

5305, Black with Walnut, RMEF



HI POWER

MODEL	DESCRIPTION	BULB	CODE #	SUGG. RETAIL	BATTERIES	BATTERY LIFE	BRIGHTNESS
5303	NEW Hi Power, Gun Finish Matte Silver with American Walnut	Cree XPE LED	3715303	\$74.99	(2) AA Alkaline	1.5 hours	145 Lumens
5304	NEW Hi Power, Matte Finish Desert Metallic with Black Resin	Cree XPE LED	3715304	74.99	(2) AA Alkaline	1.5 hours	145 Lumens
5302	NEW Hi Power, MONBU with Black Resin and Dura-Touch Armor Coating	Cree XPE LED	3715302	74.99	(2) AA Alkaline	1.5 hours	145 Lumens
5301	NEW Hi Power, Gun Finish Matte Black with American Walnut	Cree XPE LED	3715301	74.99	(2) AA Alkaline	1.5 hours	145 Lumens
5305	NEW Hi Power, Gun Finish Matte Black with American Walnut with RMEF logo	Cree XPE LED	3715305	74.99	(2) AA Alkaline	1.5 hours	145 Lumens

TACTICAL HUNTER FLASHPOINT FLASHLIGHTS

NEW

The new Browning Flashpoint is the most powerful two battery flashlight we've ever offered. This wonder combines the latest Luxeon® LED with a pair of 3V Lithium batteries and advanced electronics, for a flashlight that outperforms all others.

Aside from tremendous light output and great battery life, what really stands out are the three brightness levels available (high [100%], medium

[60%], low [10%]) and two flashing modes (fast strobe and S.O.S.). A rotating selector switch on the tailcap controls the electronics and a tactical, push button on-off switch on the end of the light makes it easy to turn the light on in a momentary function. Try a new Flashpoint and it is easy to see why this light will outshine the rest of the contenders in the portable lighting market.



1240, Black

L = LIGHT
High-Medium-Low

O = OFF

F = FLASHING
Fast strobe or SOS

M = MOMENTARY

Flashpoint Rotating Selector Switch



1241,
Mossy Oak® New Break-Up®

- All-aluminum construction and O-ring sealed for water-resistance
- Advanced digital circuitry delivers maximum power
- Rugged Tactical Hunter design with lock-out switch and Deep Pocket™ carry clip
- Length: 5.6"
- Brightness: 175 lumens
- Effective distance: 150 meters

MODEL	DESCRIPTION	BULB	CODE #	SUGG. RETAIL	BATTERIES	BATTERY LIFE	BRIGHTNESS
1240	NEW Tactical Hunter Flashpoint, Black	Luxeon Rebel LED	3711240	\$74.99	(2) CR123A Lithium	High: 2.5 hours	175 Lumens
1241	NEW Tactical Hunter Flashpoint, MONBU and Dura-Touch Armor Coating	Luxeon Rebel LED	3711241	79.99	(2) CR123A Lithium	High: 2.5 hours	175 Lumens

NITRO HEADLAMP

Our brightest, most-powerful headlamp
 · Luxeon® Rebel LED shines 100 meters on high setting; plus two red and two green LEDs
 · Lock-out switch with settings for high and low
 · LEDs are unbreakable and are rated for 100,000 hours use
 · CR123A battery operates to -40° F
 · Includes headstrap, or use with hat clip
 · Glass-fiber reinforced polycarbonate housing with aluminum lens ring
 · Silent Hinge™ for stealth
 · Brightness: 110 lumens
 · Effective distance: 100 meters

Martin Buser and his Happy Trails Kennels sled dog teams have won the grueling 1,161 mile Iditarod Trail Sled Dog Race an impressive four times. Their 1997 victory still holds the course record for the fastest finish time. During the 2008 and 2009 race, Martin relied on the Browning Nitro headlamp to steer his team through the darkest Alaskan nights. "I am always searching for durable, unique products to give me an edge. The long-reaching, focused beam of the Nitro stretches past 80 feet of the sled team and makes finding trail markers easier. The lithium batteries are great because they last longer and are less affected by the cold than alkaline batteries."

— MARTIN BUSER

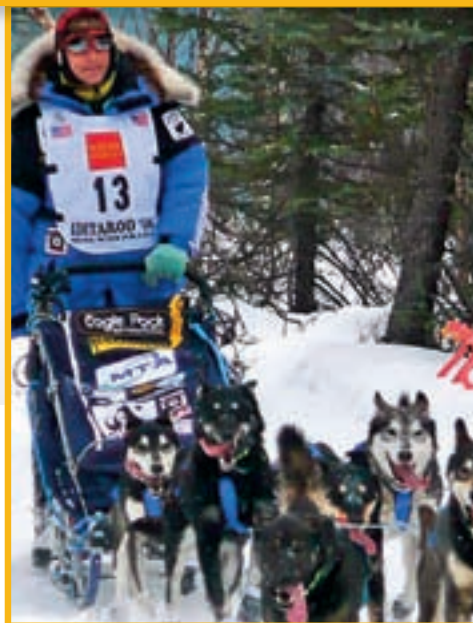

8620

NEW
20% BRIGHTER LED

NITRO

MODEL	DESCRIPTION	BULB	CODE #	SUGG. RETAIL	BATTERIES	BATTERY LIFE	BRIGHTNESS
8620	Nitro Max Output Headlamp, MONBU	135 Lumen Luxeon Rebel LED + (2) Red, (2) Blue LED	3718620	\$49.99	(1) CR123A Lithium	High: 3 hours; Low: 8 hours Red, Blue LEDs: 15 hours	110 Lumens

ALPHA, ALPHA MAX AND ZETA FLASHLIGHTS

Browning flashlights are more powerful for 2010 with innovative new LED bulbs that provide more illumination. Compact and powerful, these flashlights use standard AA alkaline batteries and fit easily in a pocket. A lock-out tailcap switch features a momentary function, and single-action on-off for simplicity and maximum control. Rugged

aircraft aluminum construction protects the high-tech circuitry and the unbreakable LEDs. The Deep Pocket™ carry clip holds the light securely in your pocket where it's easy to find. The Deep Pocket carry clip is removable when it's not needed. Check out the latest innovations in handheld lighting technology, available from Browning.

NEW
BRIGHTER LED



1242

TACTICAL HUNTER

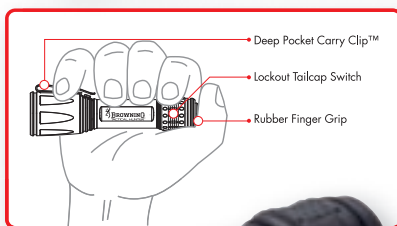

- Alpha delivers 75 lumens; Alpha Max delivers 100 lumens, shines over 100 meters, and is no bigger than a shotgun shell
- Digital circuitry delivers maximum power using only one battery
- Rugged Tactical Hunter design with lock-out switch and Deep Pocket™ carry clip
- Mossy Oak® New Break-Up® flashlights feature Dura-Touch® Armor Coating
- Length - Alpha: 3.75" · Alpha Max: 3.9" · Zeta: 5.9"
- Brightness - Alpha: 75 lumens · Alpha Max: 100 lumens · Zeta: 120 lumens
- Effective distance - Alpha: 60 meters · Alpha Max: 100 meters · Zeta: 120 meters



1231

NEW
25% BRIGHTER LED



NEW

1239

1232

NEW
10% BRIGHTER LED

MODEL	DESCRIPTION	BULB	CODE #	SUGG. RETAIL	BATTERIES	BATTERY LIFE	BRIGHTNESS
1231	Tactical Hunter Alpha, Black	Luxeon Rebel LED	3711231	\$39.99	(1) AA Alkaline	1.5 hours	75 Lumens
1239	NEW Tactical Hunter Alpha Max, Black	Cree XR-E LED	3711239	49.99	(1) AA Alkaline	1.5 hours	100 Lumens
1232	Tactical Hunter Alpha Max, MONBU	Cree XR-E LED	3711232	54.99	(1) AA Alkaline	1.5 hours	100 Lumens
1242	NEW Tactical Hunter Zeta	Cree XR-E LED	3711242	59.99	(2) AA Alkaline	3 hours	120 Lumens

TNT AND CATALYST FLASHLIGHTS

NEW



1243

NEW

- Rugged, tactical-style thumb switch with lock-out switch
- TNT and Catalyst MONBU models have a single-action on-off switch, while Catalyst (Olive Drab and Digi Camo models) have an electronic high-low switch and a rapid strobe function
- Features the brightest available LEDs for maximum distance and lumens
- Deep Pocket™ carry clip keeps the light secure in your pocket
- Three colored filters (red, blue, green) for maximum stealth and night vision
- All-aluminum construction with unbreakable lens
- Mossy Oak® New Break-Up® flashlights feature Dura-Touch® Armor Coating
- Length - Catalyst: 5" · TNT: 4.15"
- Brightness - TNT: 135 lumens · Catalyst: 175 lumens
- Effective distance - TNT: 125 meters · Catalyst: 150 meters



1230

NEW
20% BRIGHTER LED



1229

NEW
20% BRIGHTER LED



NEW
20% BRIGHTER LED

1235

TACTICAL HUNTER

HUNT MASTER



1236

NEW
50% BRIGHTER LED

- The brightest light in our line-up with an incredible 300 lumens
- Focusable lens for flawless spot beam
- Small, lightweight, easy to carry and smaller than a 2D flashlight
- CR123A batteries operate to -40° F
- All-aluminum construction with unbreakable lens
- High-power LEDs are rated for 100,000 hours use
- Length: 6.6"
- Brightness: 300 lumens
- Effective distance: 150 meters

MODEL	DESCRIPTION	BULB	CODE #	SUGG. RETAIL	BATTERIES	BATTERY LIFE	BRIGHTNESS
1229	TNT, MONBU	Luxeon Rebel LED	3711229	\$59.99	(1) CR123A Lithium	2 hours	135 Lumens, 125 meters
1243	NEW Catalyst, Digital Camo	Luxeon Rebel LED	3711243	69.99	(2) CR123A Lithium	2.5 hours	175 Lumens, 150 meters
1230	Catalyst, MONBU	Luxeon Rebel LED	3711230	69.99	(2) CR123A Lithium	High: 2.5 hours; Low: 12 hours	175 Lumens, 150 meters
1235	Catalyst, Olive Drab	Luxeon Rebel LED	3711235	64.99	(2) CR123A Lithium	High: 2.5 hours; Low: 12 hours	175 Lumens, 150 meters
1236	Hunt Master, Olive Drab	(3) Luxeon Rebel LEDs	3711236	99.99	(3) CR123A Lithium	High: 3.5 hours; Low: 8 hours	300 Lumens, 150 meters

MICROBLAST HEADLAMP

MICROBLAST

- Ultra-light headlamp is super bright and so small it goes unnoticed when wearing it
- Two Nichia® white LEDs for distance and general-purpose use, one green LED for stealth, safety and night vision
- Rugged polymer construction with Silent Hinge™
- Includes headstrap for use as a headlamp, or hat clip to attach to a cap
- Brightness: 10 lumens
- Effective distance: 15 meters



2121



2121



2121

MICROBLAST FLASHLIGHTS



2114

2115

- Use as flashlight or cap light
- 0.5W LED is brighter than most AAA flashlights
- Digital circuitry delivers maximum power using only one battery
- All aluminum construction with unbreakable lens

- O-ring sealed for water-resistance
- Length: 2.9"
- Effective distance: 35 meters
- Brightness: 20 lumens



2114

MICROBLAST PEN LIGHTS WITH BORE ADAPTERS

- Superbright Nichia® 5mm LED shines at 15 lumens, 3X brighter than most other pen lights
- Two Bore Light Adapters included with AAA MicroBlast: red for map reading and white for firearm inspection and cleaning
- Covert Cover™ (AAAA models) slides up for spot beam, making the light unseen from the side

- Rugged all-aluminum construction with heavy-duty pocket clip
- Unbreakable LED lasts for 100,000 hours
- Two sizes: Ultra-slim with three AAAA batteries
- Standard with two AAA batteries and for general use
- Brightness: 15 lumens
- Effective distance: 20 meters



2120

2123

NEW

MODEL	DESCRIPTION	BULB	CODE #	SUGG. RETAIL	BATTERIES	BATTERY LIFE	BRIGHTNESS
2121	MicroBlast Headlamp with hat clip	(2) 5mm Nichia White LEDs, (1) Green LED	3712121	\$14.99	(2) 2032 Lithium	White LEDs: 5 hours; Green LED: 33 hours	10 Lumens
2114	MicroBlast, Black	0.5 Watt White Luxeon LED	3712114	19.99	(1) AAA Alkaline	Up to 1.5 hours	20 Lumens
2115	MicroBlast, MONBU	0.5 Watt White Luxeon LED	3712115	24.99	(1) AAA Alkaline	Up to 1.5 hours	20 Lumens
2120	MicroBlast Pen Light w/ Bore Adapter, Titanium	(1) 5mm Nichia White LED	3712120	14.99	(3) AAAA Alkaline	30 hours	15 Lumens
2123	NEW MicroBlast Pen Light w/ 2 Bore Adapters, Charcoal	(1) 5mm Nichia White LED	3712123	14.99	(2) AAA Alkaline	10 hours	15 Lumens

PRO HUNTER LED FLASHLIGHTS

Lightweight Pro Hunter Flashlights are constructed from a rugged polymer and are topped off with a machined aluminum lens cap for added durability. Powered by AAA batteries, Pro Hunter LED lights feature the combination of a 0.5 watt LED for long-distance illumination and 5mm LEDs for close-up distances and extended run times. New Pro Hunter RGB features a red/green/blue LED, 2 white LEDs for long distance, and 1 white LED for up close flood beam.

- Combination long-distance, long run-time flashlights with colored LEDs for maximum stealth, safety and night vision
- All-LED for ultimate reliability
- 100,000 hour LEDs never need replacement
- Ultra-light, ultra-tough polymer construction with rugged aluminum lens ring
- Textured non-slip body for secure grip in wet weather
- O-ring sealed for water-resistance
- Length - 5.1"
- Pro Hunter - Brightness: 25 lumens · Effective distance: 50 meters
- Pro Hunter RGB - Brightness: 30 lumens · Effective distance: 25 meters

PRO HUNTER

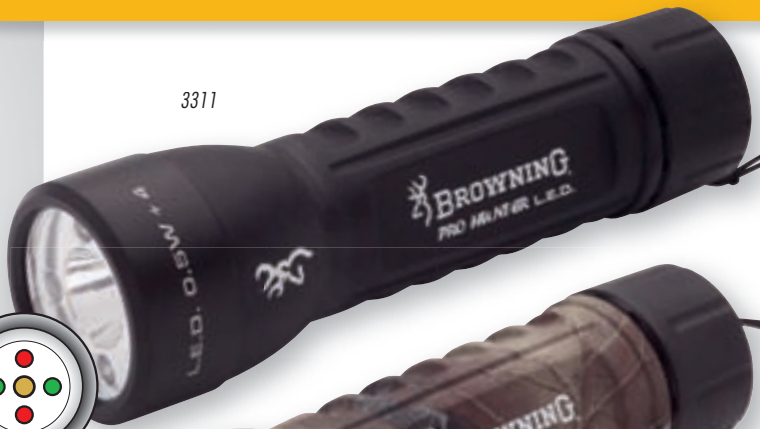

3311



3312



3314



MODEL	DESCRIPTION	BULB	CODE #	SUGG. RETAIL	BATTERIES	BATTERY LIFE	BRIGHTNESS
3311	Pro Hunter LED, Black	Nichia 0.5 Watt LED + (2) 5mm Green, (2) Red LEDs	3713311	\$24.99	(3) AAA Alkaline	0.5 watt: 6 hours; 5mm: 30 hours	25 Lumens
3312	Pro Hunter LED, MOBU	Nichia 0.5 Watt LED + (2) 5mm Green, (2) Red LEDs	3713312	29.99	(3) AAA Alkaline	0.5 watt: 6 hours; 5mm: 30 hours	25 Lumens
3314	NEW Pro Hunter RGB	Nichia wide beam white LED + (2) 5mm White, (1) RGB LED	3713314	19.99	(3) AAA Alkaline	5mm white: 30h; wide beam LED: 40 hours	30 Lumens

SPITFIRE FLASHLIGHT

The rugged, super bright LED Spitfire Flashlight operates on 2 AA batteries. A great value, this tough, reliable flashlight is water-resistant and easily passes demanding "drop-tests" onto concrete from a height of 1 meter and higher. The highly-focused LED beam is tuned for long distances and shines out to 120 meters. A tactical-style tailcap switch is easy to operate and features a momentary on-off or lock-on.



4120

NEW

- Powerful Cree® LED for bright, reliable illumination
- LEDs are rated for 50,000 hours and will never need to be replaced
- Ultra-light, ultra-tough machined aluminum construction repeated passed a one-meter drop test onto concrete
- Textured non-slip body for secure grip in wet weather
- O-ring sealed for water-resistance
- Length - 5.1"
- Brightness: 80 lumens
- Effective distance: 120 meters

MODEL	DESCRIPTION	BULB	CODE #	SUGG. RETAIL	BATTERIES	BATTERY LIFE	BRIGHTNESS
4120	NEW Spitfire	Cree XR-C LED	3714120	\$29.99	(2) AA Alkaline	1.75 hours	80 Lumens

BLACK ICE FLASHLIGHTS



5151



CALIBER



5061



MAGNUM

- Black Ice Caliber and Magnum combination long-distance and long-run time flashlights are Browning customer favorites
- Powerful distance beams use the latest Xenon bulb technology
- Multiple LED colors for stealth, improved night vision, and maximum battery life

- All-aluminum construction with Mossy Oak® camouflage and rugged Dura-Touch® Armor Coating for a secure grip in wet weather
- Smart Switch™ for maximum control and ease-of-use
- Length - Caliber: 5.9" · Magnum 8"
- Caliber - Brightness: 80 lumens
- Effective distance: 100 meters
- Magnum - Brightness: 120 lumens
- Effective distance: 150 meters



Browning's unique Smart Switch allows the user to select either a brightness setting or the LED color, and retain this setting each time the flashlight is turned on or off. After selecting the desired setting, just hold the switch down for one second and the light will turn off. Push again to instantly return to that setting.



5191



EXO



5221



AVALANCHE

- Xenon bulbs and CR123A lithium batteries make an unbeatable team for long-distance flashlights
- Spot-to-Flood adjustment allows for distance and up-close lighting
- Black Ice lights are the answer for hunters when finding a deer stand, looking for the trail or seeing what's moving in the dark
- Rugged all-aluminum construction with Mossy Oak® camouflage and Dura-Touch® Armor Coating for a secure grip in wet weather
- Lightweight lithium batteries don't dim as their capacity is used up and operate to -40° F

- O-ring sealed for water-resistance
- Length - Exo: 5.9" · Avalanche: 5.5"
- Avalanche - Brightness: 85 lumens
- Effective distance: 100 meters
- EXO - Brightness: 100 lumens
- Effective distance: 125 meters



MODEL	DESCRIPTION	BULB	CODE #	SUGG. RETAIL	BATTERIES	BATTERY LIFE	BRIGHTNESS
5151	Caliber MONBU, 6V Xenon + 6 LED	(1) Xenon + LEDs: (2) Red, (2) White, (2) Blue	3715151	\$59.99	(2) CR123A Lithium	Xenon: 1.5 hours; LEDs: 24 hours	80 Lumens
5061	Magnum, Xenon + 8 LED, MONBU	Xenon + (2) Red, (2) White, (2) Blue, (2) Green LEDs	3715061	79.99	(3) CR123A Lithium	Xenon: 2 hours; LEDs: 36 hours	120 Lumens
5191	EXO 9V Xenon, MONBU	(1) 7.2V 0.75A High Pressure Xenon	3715191	49.99	(3) CR123A Lithium	Up to 2 hours	100 Lumens
5221	Avalanche 6V Xenon, MONBU	(1) 4.8V 0.9A High Pressure Xenon	3715221	39.99	(2) CR123A Lithium	Up to 1.5 hours	85 Lumens

NIGHT SEEKER RGB CAP LIGHT

NEW

The new Night Seeker™ RGB Cap Light features 2 white LEDs plus a cool RGB LED, which shines first red, then green, then blue — all from a single LED — just by pushing the switch. Like other Night Seeker Lights, the RGB is made from lightweight polymer with an integrated clip that swivels to allow the light to be directed easily.



5100

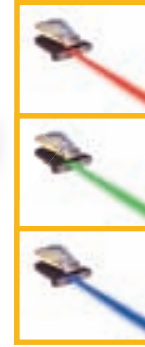

- Adjustable tilt allows the light to pivot up and down to aim the light where it is needed
- Two white LEDs for all-purpose use
- One RGB LED offers night vision, safety and stealth
- Wear on the brim of a cap, as a pocket light or on a pack strap
- LEDs are rated for 100,000 hours use
- Water-resistant
- Brightness: 15 lumens
- Effective distance: 20 meters

MODEL	DESCRIPTION	BULB	CODE #	SUGG. RETAIL	BATTERIES	BATTERY LIFE / BRIGHTNESS
5100	NEW Night Seeker RGB, MONBU	(2) Nichia 5mm LEDs + (1) 5mm RGB LED	3715100	\$11.99	(2) 2032 Lithium	White LEDs: 6.5 hours / 15 Lumens



Free Standing

Cap Light

Pocket Light

NIGHT SEEKER PRO CAP LIGHT



5099

- Adjustable tilt allows the light to pivot up and down to aim the light where it is needed
- One Nichia® 0.5 Watt LED for distance illumination
- Two green LEDs for night vision, safety and stealth
- Wear on the brim of a cap, as a pocket light or on a pack strap
- LEDs are rated for 100,000 hours use
- Water-resistant
- Brightness: 20 lumens
- Effective distance: 35 meters



5081



NIGHT SEEKER CAP LIGHT

- Adjustable tilt allows the light to pivot up and down to aim the light where it is needed
- Two white LEDs are ideal for all-purpose use; one red LED for night vision and stealth
- Wear on the brim of a cap, as a pocket light or on a pack strap
- LEDs are rated for 100,000 hours use
- Water-resistant
- Brightness: 15 lumens
- Effective distance: 20 meters

Night Seeker™
PRO Cap Light

Cap lights are one of the best ideas ever, and we have the best executed designs available. Night Seeker™ Cap lights are durably constructed from a lightweight polymer to keep weight to a minimum. An integrated clip swivels to allow the light to be directed easily. The unique clip is also highly versatile. In addition to attaching to the brim of a cap, the clip can be attached to your shirt pocket, backpack strap or folded out to allow the light to stand on its own.

Night Seeker™

MODEL	DESCRIPTION	BULB	CODE #	SUGG. RETAIL	BATTERIES	BATTERY LIFE / BRIGHTNESS
5099	Night Seeker Pro, Black	Nichia 0.5 Watt LED + (2) 5mm Green LEDs	3715099	\$14.99	(1) AAA Alkaline	0.5W LED: 1.5 hours / 20 Lumens
5081	Night Seeker Cap Light, Black	(2) 5mm White LEDs, (1) Red LED	3715081	9.99	(2) 2032 Lithium	White LEDs: 6.5 hours / 15 Lumens

KNIFE AND LIGHT COMBOS

NIGHT SEEKER CAP LIGHT

- Adjustable tilt allows the light to pivot up and down to aim the light precisely where you need it
- Two white LEDs are ideal for all-purpose use
- One red LED for night vision and stealth
- Wear on the brim of a cap, as a pocket light or on a pack strap
- LEDs are rated for 100,000 hours use
- Brightness: 15 lumens
- Effective distance: 20 meters

Night Seeker™



NIGHT SEEKER KNIFE

- Folding knife with durable frame lock
- 2½" stainless steel blade holds a sharp edge
- Thumb stud and pocket clip

MICROBLAST LIGHT

- Use as flashlight or cap light
- 5mm LED is brighter than many 2AA flashlights
- Digital circuitry delivers maximum power using only one battery
- All aluminum construction with unbreakable lens
- O-ring sealed for water-resistance
- Length - 2.9"
- Brightness: 15 lumens
- Effective distance: 20 meters

MICROBLAST



MICROBLAST KNIFE

- Folding knife with durable frame lock
- 2" stainless steel blade holds a sharp edge

MODEL	DESCRIPTION	BULB	CODE #	SUGG. RETAIL	BATTERIES	BATTERY LIFE / BRIGHTNESS
5082	Night Seeker Light/Knife Combo, Black	(2) 5mm White LEDs, (1) Red LED	3715082	\$17.99	(2) 2032 Lithium	White LEDs 6.5 hours / 15 Lumens
5083	Night Seeker Light/Knife Combo, MOBU	(2) 5mm White LEDs, (1) Red LED	3715083	19.99	(2) 2032 Lithium	White LEDs 6.5 hours / 15 Lumens
2118	NEW MicroBlast Knife/Light Combo, Pink	5mm White LED	3712118	19.99	(1) AAA Alkaline	Up to 7 hours / 15 Lumens
2219	NEW MicroBlast Knife/Light Combo, Charcoal	5mm White LED	3712219	19.99	(1) AAA Alkaline	Up to 7 hours / 15 Lumens

DUCK CALL LANYARD LIGHT

NEW



- Designed to clip to a call lanyard
- Nichia® 0.5 Watt LED is brighter than many larger flashlights
- Digital circuitry delivers maximum power using a single AAA battery
- Twist-switch prevents accidental activation
- Rugged aircraft aluminum housing with unbreakable LED and lens
- Extra-strong metal lanyard with spring clip
- Effective distance: 35 meters

MODEL	DESCRIPTION	BULB	CODE #	SUGG. RETAIL	BATTERIES	BATTERY LIFE / BRIGHTNESS
2122	NEW Duck Call Lanyard Light	Nichia 0.5 Watt LED	3712122	\$19.99	(1) AAA Alkaline	1.5 hours / 20 Lumens



BLACK ICE HEADLAMPS

When it comes to portable lighting, there is no more versatile choice than a good headlamp. We offer a wide selection of compact, durable headlamps ready to tackle virtually any task. All headlamps feature powerful, unbreakable LEDs connected to advanced circuitry that maximizes light output and battery life. Our headlamps utilize the highest quality LEDs to ensure long-lasting reliability. All headlamps include a comfortable, fully-adjustable headband, and three models also have a handy clip to attach the light to the brim of your cap.



8161

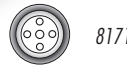

8171





Hat Clip



8141



- Ultra-light, ultra-bright headlamps with powerful distance beams and colored LEDs for long battery life, stealth and improved night vision
- New Nichia® white LEDs are twice as bright as the previous generation of LEDs
- White, red or green LEDs, plus flashing mode
- Wear as a headlamp or clip to your hat
- Brightness: 50 lumens, WRG (white, red, green) LED: 25 lumens
- Effective distance: 40 meters, WRG (white, red, green) LED: 30 meters

MODEL	DESCRIPTION	BULB	CODE #	SUGG. RETAIL	BATTERIES	BATTERY LIFE	BRIGHTNESS
 8141	Renegade 5 LED Headlamp, MONBU	5mm LEDs (2) White (2) Red, (1) Green	3718141	\$39.99	(3) AAA Alkaline	(2) Red, (2) White: 18h; (1) Green: 50h	25 Lumens
 8161	Renegade 5 LED Headlamp, Black	(5) 5mm White LEDs	3718161	34.99	(3) AAA Alkaline	(5) LEDs: 8h; (3) LEDs: 14h; (1) LED: 32h	50 Lumens
 8171	Renegade 5 LED Headlamp, MONBU	(5) 5mm White LEDs	3718171	39.99	(3) AAA Alkaline	(5) LEDs: 8h; (3) LEDs: 14h; (1) LED: 32h	50 Lumens





8501

The Summit is our most rugged AAA battery headlamp. This compact wonder weighs an incredible 2.6 ounces with two batteries. The 0.5 watt LED provides far-reaching light and a pair of red 5mm LEDs provide night vision saving illumination. A comfortable elastic headstrap is included, plus a clip that allows the Summit to attach to the brim of your cap.



8502

- Ultra-light, ultra-bright headlamps with powerful distance beams and colored LEDs for long battery life, stealth and improved night vision
- Nichia 0.5 watt white LED for distance plus two red LEDs
- Wear as a headlamp or clip to a hat
- Brightness: 20 lumens
- Effective distance: 35 meters

MODEL	DESCRIPTION	BULB	CODE #	SUGG. RETAIL	BATTERIES	BATTERY LIFE	BRIGHTNESS
 8501	Summit, Black	(1) 0.5 Watt LED + (2) Red, LEDs	3718501	\$19.99	(2) AAA Alkaline	0.5W LED: 4 hours; LEDs: 15 hours	20 Lumens
 8502	Summit, MONBU	(1) 0.5 Watt LED + (2) Red, LEDs	3718502	24.99	(2) AAA Alkaline	0.5W LED: 4 hours; LEDs: 15 hours	20 Lumens

PHANTOM 70 HEADLAMPS

PHANTOM



8343



Hat Clip

- Our brightest, lightest weight headlamp
- Only 2.4 oz. including single AA battery
- Choose between red, green, or blue LEDs, plus a powerful Luxeon® white LED for distance
- Pivoting optical diffuser for flood lighting
- Clips to a cap or use with headstrap
- Brightness: 50 lumens
- Effective distance: 70 meters

The Phantom headlamp is the smallest, most powerful AA headlamp in our line-up. It is lightweight and compact, featuring a flip-down diffuser that softens light into a flood beam for up close tasks. A comfortable elastic headstrap and easy-to-use hat clip are included.

MODEL	DESCRIPTION	BULB	CODE #	SUGG. RETAIL	BATTERIES	BATTERY LIFE	BRIGHTNESS
8343	Phantom, MOBU	Luxeon Rebel LED + (1) Red, (1) Green, (1) Blue 5mm LEDs	3718343	\$44.99	(1) AA Alkaline	Rebel LED: 1.5 hours; 5mm LEDs: 25 hours	50 Lumens

DAKOTA HEADLAMPS

Lightweight 3 AAA battery-powered Dakota combination headlamps are built from a durable polymer for strength. LEDs and a far-reaching Xenon bulb provide perfect lighting.



8201

8241

DAKOTA

- Combination Xenon bulb for distance plus three LEDs for long-battery life
- Choose between 3 Nichia® white LEDs, or white, blue and red LEDs
- Up to 32 hours battery run time
- Brightness: 17 lumens
- Effective distance: 40 meters

MODEL	DESCRIPTION	BULB	CODE #	SUGG. RETAIL	BATTERIES	BATTERY LIFE	BRIGHTNESS
8201	Dakota MONBU	(1) Xenon + (3) White LEDs	3718201	\$39.99	(3) AAA Alkaline	Xenon: 3 hours; 3 LEDs: 14 hours; 1 LED: 32 hours	17 Lumens
8241	Dakota MONBU	(1) Xenon + (1) White (1) Red (1) Blue LEDs	3718241	39.99	(3) AAA Alkaline	Xenon: 3 hours; Red, Blue, White LED: 32 hours	17 Lumens

BLACK ICE KEYCHAIN LIGHTS

- Nichia® 5mm white LEDs are twice as bright as previous generation LEDs
- Rugged aluminum construction with unbreakable lens
- Twist-style, lock-out switch
- Length - 2.6"
- Brightness: 11 lumens
- Effective distance: 16 meters



3341



3351

BLACK ICE

A convenient Browning Keychain Light can always be at the ready. These high quality lights are built to last with rugged aluminum construction and a single long-lasting LED.

MODEL	DESCRIPTION	BULB	CODE #	SUGG. RETAIL	BATTERIES	BATTERY LIFE	LAMP HRS.	BRIGHTNESS
3341	Black	(1) 5mm White LED	3713341	\$11.99	(3) S736S	Up to 7 hours	100,000 hours	11 Lumens
3351	MONBU	(1) 5mm White LED	3713351	14.99	(3) S736S	Up to 7 hours	100,000 hours	11 Lumens

ECHO KEYCHAIN LIGHTS

NEW

The bright, easy to carry Echo Keychain Light lights clip to a keychain and feature a long-lasting LED plus momentary and lock-on functions.

- Nichia® 5mm white LED
- Ultralight ½ oz. weight
- (2) replaceable 2016 lithium batteries included
- Rugged polymer construction with rubber side grips and push-button
- Brightness: 12 lumens
- Effective distance: 18 meters



MODEL	DESCRIPTION	BULB	CODE #	SUGG. RETAIL	BATTERIES	BATTERY LIFE	LAMP HRS.
3389	NEW Black	(1) 5mm White LED	3713389	\$7.99	(2) 2016 Lithium	Up to 9 hours	100,000 hours
3390	NEW MONBU	(1) 5mm White LED	3713390	9.99	(2) 2016 Lithium	Up to 9 hours	100,000 hours

BUCKMARK 6D LANTERN

NEW



There isn't a better camp lantern than the new Buckmark 6D. The primary light source is a replaceable fluorescent bulb which puts out 350 lumens for 12 hours, perfect for use around camp and general purpose lighting. The second light source is a 0.5 watt white LED that will run for 168 hours (7 days) when long-term lighting, such as in an emergency situation, is needed. The third light source is a pair of 5mm red LEDs that will run for 264 hours (11 days) for stealth lighting or reading a map and long-term use as a marker, a night light, or hanging in the tent. The red LEDs can also be set to blinking mode in an emergency.

- Bright fluorescent and LED lantern
- Steady on and flashing modes
- Durable polymer and metal construction with rubber accents for durability
- Brightness: 350 lumens (Fluorescent)
- Height: 9.25"

7204

FLASHLIGHT POUCHES

MODEL	DESCRIPTION	CODE #	SUGG. RETAIL
9100	Small Flashlight Pouch, MONBU	3749100	\$9.99
9200	Small Flashlight Pouch, Black	3749200	9.99
9000	Large Flashlight Pouch, MONBU	3749000	11.99
9300	Large Flashlight Pouch, Black	3749300	11.99

- Rugged Cordura® nylon in black and Mossy Oak® New Break-Up® camo (Lights not included)
- Full range of adjustments using hook and loop fasteners and a polymer snap buckle
- Large pouches fit flashlights up to 6.6"
- Small pouches fit flashlights up to 5"



9200

9100

9000

9300

MODEL	DESCRIPTION	BULB	CODE #	SUGG. RETAIL	BATTERIES	BATTERY LIFE
7204	NEW Buckmark Lantern	Fluorescent; 0.5 Watt LED; (2) Red 5mm LEDs	3717204	\$79.99	(6) D Alkaline (not included)	F: 12h; 0.5W: 168 hours; (2) Red LEDs: 264 hours

BROWNING ALL-TEMPERATURE LITHIUM BATTERIES



CR123A Batteries



2032 Lithium Batteries

- Lithium batteries deliver about twice the power per gram as alkaline batteries, and don't decline in power output as the batteries are consumed like alkaline
- CR123A Batteries operate from -40° F to 140° F
- 10-year shelf life

DESCRIPTION	CODE #	SUGG. RETAIL
CR123A Batteries (2-pack)	3742000	\$5.99
2032 Batteries (4-Pack)	3742100	4.99

REPLACEMENT BULBS

MODEL	DESCRIPTION	BULB	CODE #	SUGG. RETAIL
3000	Avalanche, Caliber 6V Flashlights	Xenon 4.8V, 0.9A	3743000	\$7.99
5000	EXO 9V Flashlight	Xenon 7.2V, 0.75A	3745000	7.99
5510	Magnum 9V Flashlights	Xenon 8.4V, 1A	3745510	7.99
8000	Dakota 4.5V Headlamp	Xenon 3V, 0.3A	3748000	7.99
7200	Buckmark Lantern	13 Watt Fluorescent	3747200	22.49



CLOTHING SIZING CHART

FOR HER SIZES



	S		M		L		XL		2XL
Size	4	6	8	10	12	14	16	18	20
Neck	11½"	12½"	12½"	13½"	13½"	14½"	14½"	15½"	15½"
Sleeve	30"	30"	31"	31"	32"	32"	33"	33"	34"
Bust	33½"	34½"	35½"	36½"	38"	39½"	41"	43"	45"
Waist	25½"	26½"	27½"	28½"	30"	31½"	33"	35"	37"
Hip	35½"	36½"	37½"	38½"	40"	41½"	43"	45"	47"
Inseam	30"	30"	30"	30"	32"	32"	32"	32"	32"

JUNIOR SIZES



	S		M		L		XL	
Size	6	8	10	12	14	16	18	20
Height	45-48"	49-52"	53"	58"	59"	63"	66½"	68½"
Chest	26"	27"	28"	30"	31"	33"	35"	36½"
Waist	22½"	23½"	24"	25"	26"	27"	29"	30"
Hip	27"	28"	30"	32"	33"	34"	34"	35½"

Kid's caps: 6½", fits ages 18 months to 3 years old
 Youth caps: 6⅞", fits ages 4-9

MEN'S SIZES

MEN'S APPAREL

Every garment is designed and built to the specifications on the charts below. Offered in 3XL sizes in many styles, which are cut larger throughout.

Size	Chest	Waist	Neck	Arm
S	37-39"	28-31"	14-14½"	32-33"
M	40-42"	32-35"	15-15½"	33-34"
L	43-45"	36-39"	16-16½"	34-35"
XL	46-48"	40-43"	17-17½"	35-36"
2XL	49-51"	44-46"	18-18½"	36-37"
3XL	52-54"	47-49"	18-19"	36-37"

MEN'S GLOVES

Measure around the flat of the hand just below the knuckles, excluding the thumb. Number of inches around hand equals glove size.

XS	7-7½"
S	8-8½"
M	9-9½"
L	10-10½"
XL	11-11½"

CLOTHING



CLOTHING INDEX

ADDHEAT	
Extra Battery	189
Hell's Canyon Jacket	193
Power Pack	189
Vehicle Charger	189
Vest	189
XPO Big Game Insulated Parka	190
BLAZE	
Big Country Vest	214
Caps	232
Hell's Canyon	193-194
Hooded Sweatshirt and Vest	214
Safety Vest	214
BIG GAME	
650 Down	205
700 Fill Power Down	178
Blaze	193-194, 214
Dry-Lite	201
Full Curl Wool	206-207
Hell's Canyon	193-195
Highlands II Wool	208-209
TF-300 Fleece	202-203
Transitions Series	175-182
Tri-Vent/Illusion	213
Wasatch	210-212
XPO Big Game	190-192
CAPS AND HATS	
Camo	231-232
Casual	233-234
Felt Hats	234
Safety	232
Wax Fabric	233
DOWN	
650 Down	205
700 Fill Power Down	178, 186
Junior Down Jackets	203
Santa Fe Down Jacket	204
FIELDWEAR	
Illusion	213
Tri-Vent	213
Wasatch	210-212
FOR HER	
Sporter Double Action Shooting Vest	227
Trapper Creek Mesh Back Shooting Gloves	230
XPO Big Game	192
JUNIOR	
Blaze Safety Vest	214
Down Jacket	203
Sporter Double Action Shooting Vest	227
TF-300 Fleece	203
XPO Big Game	192



CLOTHING INDEX

SHOOTING CLOTHING	
Badger Creek Shirts	229
Ballistic Insulated Shooting Jacket	225
Broken Birds Vest	226
Deluxe Mesh Vest	228
Leather Tac-Pro Gloves	230
Mesh Back Shooting Gloves	230
Mahave S/S NTS Shirts	229
REACTAR Pads and Harnesses	230
Santa Fe Vest	228
Shooting Towel	230
Sporter Double Action Vest	227
SXS Vest	226
Trapper Creek Half Vest	228
Trapper Creek Mesh Gloves	230
SIZING CHART	
	172



TRANSITIONS SERIES

4X Microfleece	177, 185
700 Fill Power Down	178, 186
NTS and Endurance Fleece	176, 184
Escape Windstopper	181
Gore-Tex Paclite	188
Maxus Gore-Tex Jacket	187
Pursuit	180
Quest Gore-Tex	179
Zero Gravity Paclite	182

TRANSITIONS: BASE LAYER

NTS Base Layer	176
Endurance / Comfort Fleece	184

TRANSITIONS: INSULATION LAYER

4X Microfleece	177, 185
700 Fill Power Down	178, 186

TRANSITIONS: PROTECTION LAYER

Escape Windstopper	181
Gore-Tex Paclite	188
Maxus Gore-Tex Jacket	187
Pursuit	180
Quest Gore-Tex	179
Zero Gravity Paclite	182

UPLAND CLOTHING

Cross Country	218
Game Vests/Bags	218, 220-221
Gore-Tex Upland	219
Lyons Hunt Gear	220
Pheasants Forever	215-217
Prairielands Shirts	222-223
Sweatshirts and Sweaters	223-224
Tri-Vent	222

WATERFOWL

650 Down	205
700 Fill Power Down	186
Transitions	183-188
Warm Front	200
Wasatch	210-212
Windcutter Waterfowl	199
Wing-Set Jacket	196
XPO Grand Passage	197-198

WOOL

Full Curl	206-207
Highlands II	208-209

BOOKS

ARS MECHANICA	225
JOHN M. BROWNING BIOGRAPHY	225

HATE BEING SWEATY, STINKY, WET AND COLD?



TRANSITIONS®
base · insulation · protection

The innovative Transitions® Series is the solution!

Look for the tags shown on the opposite page to identify Browning Transitions Series clothing, and the specific layers of protection you need to optimize comfort in the conditions you hunt in.





«NTS»
NEXT TO SKIN



BASE layer

Base layers like the NTS Pro Shirt shown utilize fabrics to wick perspiration away from the skin and keep you warm and dry, not cold and clammy, even when moving. Antimicrobial technology is added to Big Game garments to control the growth of odor-causing bacteria to reduce human scent.

LOOK FOR THESE BASE LAYER MODELS:

NTS (NEXT TO SKIN) | ENDURANCE FLEECE | COMFORT FLEECE



700
FILL POWER



INSULATION layer

A variety of insulation layers are available to meet specific needs based on weather conditions and activity level. In dry weather all of these Layer 2 garments make excellent outer pieces. A variety of insulation layers ranging from proven goose down to fleece fabrications like the 4X Microfleece™ Vest shown are offered.

LOOK FOR THESE INSULATION LAYER MODELS:

4X MICROFLEECE™ | 700 FILL POWER™ DOWN



PROTECTION layer

The Protection layer is the first line of defense against driving wind, rain and snow. Layer 3 garments are specifically designed to maximize protection with minimal bulk. Choose the water- and wind-resistant Pursuit™ soft shell parka to stay warm and dry or one of several other styles featuring Gore-Tex® and Windstopper®.

PURSUIT™

LOOK FOR THESE PROTECTION LAYER MODELS:

QUEST | PURSUIT | ESCAPE | ZERO GRAVITY |
MAXUS GORE-TEX® PARKA | GORE-TEX® PACLITE® PULLOVER



TRANSITIONS®
base · insulation · protection



NTS™ BASE LAYER — THE FOUNDATION OF COMFORT.

Featuring VisaEndurance® antimicrobial fabric, NTS (Next To Skin) Base Layer gear with OdorSmart™ technology is designed to provide you with advanced scent control. OdorSmart features patented encapsulated silver ion technology that inhibits the growth of odor-causing bacteria to eliminate body odors. The encapsulated silver ions work for the life of the garment, with no loss of effectiveness even after repeated washings. The wicking fabric effectively transports moisture away from the body where it quickly evaporates to keep you dry and comfortable. A lighter weight fabric under the arm enhances breathability. NTS is a solid foundation for controlling human odor and maintaining comfort on your next hunting adventure.



NTS PRO SHIRT

Midweight 100% microdenier polyester fabric · Trim fabric under the arms and down the sides is constructed of bird's-eye mesh for added breathability · OdorSmart™ technology featuring VisaEndurance® silver ion anti-microbial fabric that kills odor-causing bacteria to control human odor · Perfect when odor control is a must · Excellent moisture transfer · Dries quickly · Loose fit · Double-stitch neck for comfort · Sizes: S-2XL

NUMBER	DESCRIPTION	SUGG. RETAIL
30116920	NEW Mossy Oak Break-Up Infinity	S-2XL \$50.50
A ▶ 30116914	NEW Mossy Oak New Break-Up	S-2XL 50.50

NTS PRO PANT

Midweight 100% microdenier polyester fabric · OdorSmart™ technology featuring VisaEndurance® silver ion anti-microbial fabric that kills odor-causing bacteria to control human odor · Perfect where odor control is a must · Excellent moisture transfer · Dries quickly · Loose fit · Fly · Elastic waist · Sizes: S-2XL

NUMBER	DESCRIPTION	SUGG. RETAIL
30216920	NEW Mossy Oak Break-Up Infinity	S-2XL \$50.50
B ▶ 30216914	NEW Mossy Oak New Break-Up	S-2XL 50.50

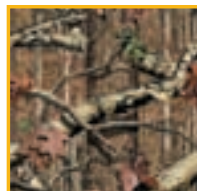

NEW FOR 2010
All items on this page are also available in Mossy Oak Break-Up Infinity camo.

NEW



A ▶ NTS Pro Shirt
New Break-Up®

«NTS»
NEXT TO SKIN



B ▶ NTS Pro Pant
New Break-Up®

NEW

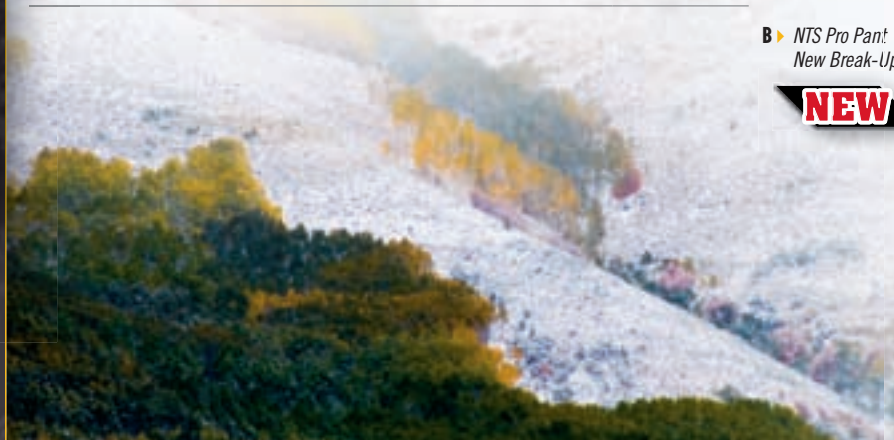

D ▶ Vest
Treestand®



4X MICROFLEECE JACKET

Highly constructed microfiber fleece is wind-resistant and extremely quiet · Backpack friendly design eliminates bulk and weight and provides easy access to pockets · Duplex handwarmer pockets feature upper and lower section separated by internal zipper · Set-in sleeves are fully lined for easy on / off and feature Lycra® cuff opening · Two zippered handwarmer pockets and internal zippered security pocket · Contrasting side stripe Sizes: S-3XL · Weight: 1 lb. 4 oz. · Center Back Length (L) 28"

NUMBER	DESCRIPTION	SUGG. RETAIL
30479020	NEW Mossy Oak Break-Up Infinity	S-XL \$112.00 2XL-3XL 125.00
C ▶ 30479014	Mossy Oak New Break-Up	S-XL 112.00 2XL-3XL 125.00
30479018	Mossy Oak Treestand	S-XL 112.00 2XL-3XL 125.00

4X MICROFLEECE VEST

Highly constructed microfiber fleece is wind-resistant and extremely quiet · Backpack friendly design eliminates bulk and weight and provides easy access to pockets · Duplex handwarmer pockets feature upper and lower sections separated by internal zipper · Two zippered handwarmer pockets and internal zippered security pocket · Contrasting side stripe · Sizes: S-3XL · Weight: 1 lb. · Center Back Length (L) 28"

NUMBER	DESCRIPTION	SUGG. RETAIL
30579120	NEW Mossy Oak Break-Up Infinity	S-XL \$87.00 2XL-3XL 100.00
30579114	Mossy Oak New Break-Up	S-XL 87.00 2XL-3XL 100.00
D ▶ 30579118	Mossy Oak Treestand	S-XL 87.00 2XL-3XL 100.00

4X MICROFLEECE PANT

Highly constructed microfiber fleece is wind-resistant and extremely quiet · Elasticized drawcord waist · Belt loops · Knee-length zippers · One rear zippered pocket · Zippered fly · Sizes: S-3XL

NUMBER	DESCRIPTION	SUGG. RETAIL
30279220	NEW Mossy Oak Break-Up Infinity	S-XL \$87.00 2XL-3XL 100.00
E ▶ 30279214	Mossy Oak New Break-Up	S-XL 87.00 2XL-3XL 100.00
30279218	Mossy Oak Treestand	S-XL 87.00 2XL-3XL 100.00

4X MICROFLEECE GLOVES

Highly constructed microfiber fleece is wind-resistant and extremely quiet · Form fitting design with textured palm and thumb overlay · Sizes: S-XL

NUMBER	DESCRIPTION	SUGG. RETAIL
30785620	NEW Mossy Oak Break-Up Infinity	S-XL \$26.00
F ▶ 30785614	NEW Mossy Oak New Break-Up	S-XL 26.00
30785618	NEW Mossy Oak Treestand	S-XL 26.00



TRANSITIONS®
base · insulation · protection



C ▶ Jacket
New Break-Up®



E ▶ Pant
New Break-Up®



F ▶ Gloves
New Break-Up®

NEW

NEW

NEW FOR 2010
All items on this page are also available in Mossy Oak Break-Up Infinity camo.



MICRO FLEECE™



TRANSITIONS®
base · insulation · protection



700 FILL POWER DOWN — LIGHT-WEIGHT WITH SUPERIOR WARMTH.

Generations of hunters have relied on Goose down to keep them warm in the coldest conditions. The reason is simple, Goose down has the highest warmth-to-weight ratio of any insulation — natural or synthetic. Our Transitions® 700 fill power goose down is specially selected for optimum loft and maximum warmth with minimal weight. The high thread count, down-proof nylon fabric features additional baffles to maintain loft and prevent down migration. Extremely breathable, layer 700 Fill Power down under any Transition outer shell for maximum protection from the elements or wear them alone as outerwear in cold, windy, dry weather.



A ► Jacket Tan

B ► Jacket Olive



700 FILL POWER DOWN JACKET

700 fill power goose down insulation provides maximum warmth with the least weight and bulk · Backpack friendly design provides easy access to pockets · Lycra® cuff and hem · Contrasting side stripe · Stuffs into internal pocket · Sizes: S-3XL · Weight: 1 lb. 4 oz. · Center Back Length (L) 28"

NUMBER	DESCRIPTION	SUGG. RETAIL
30476620	NEW Mossy Oak Break-Up Infinity	S-XL \$148.00 2XL-3XL 160.00
30476614	Mossy Oak New Break-Up	S-XL 148.00 2XL-3XL 160.00
30476618	Mossy Oak Treestand	S-XL 148.00 2XL-3XL 160.00
A ► 30476632	Tan	S-XL 140.00 2XL-3XL 148.00
B ► 30476642	Olive	S-XL 140.00 2XL-3XL 148.00

700 FILL POWER DOWN VEST

700 fill power goose down insulation provides maximum warmth with the least weight and bulk · Backpack friendly design provides access to pockets · Lycra® hem · Contrasting side stripe · Stuffs into internal pocket · Sizes: S-3XL · Weight: 15 oz. · Center Back Length (L) 28" · Weight: 1 lb. · Center Back Length (L) 28"

NUMBER	DESCRIPTION	SUGG. RETAIL
30576720	NEW Mossy Oak Break-Up Infinity	S-XL \$123.00 2XL-3XL 134.00
C ► 30576714	Mossy Oak New Break-Up	S-XL 123.00 2XL-3XL 134.00
30576718	Mossy Oak Treestand	S-XL 123.00 2XL-3XL 134.00
30576732	Tan	S-XL 117.00 2XL-3XL 123.00
30576742	Olive	S-XL 117.00 2XL-3XL 123.00



C ► Vest New Break-Up®

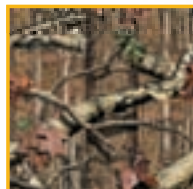

NEW
NEW FOR 2010

All items on this page are also available in Mossy Oak Break-Up Infinity camo.



D ▶ Jacket
Treestand®



E ▶ Pant
New Break-Up®



F ▶ Gloves
New Break-Up®



TRANSITIONS®
base · insulation · protection

Quest™

GORE-TEX® SOFT SHELL TECHNOLOGY

QUEST™ — MAXIMUM PROTECTION FROM THE ELEMENTS.

Quest Gore-Tex® Soft Shell garments are the ultimate all-weather protection in the field. Unlike most soft shell garments, even those that claim to be waterproof, every seam is sealed using a patented taping process that makes these garments totally waterproof, honoring the famous Gore “Guaranteed to Keep You Dry” promise. With Quest as the Protection layer, you’ll stay warm and dry in driving rain and high winds. Only bitter cold requires the addition of another insulating layer. Prepare for whatever weather comes with Quest.

QUEST GORE-TEX® SOFT SHELL JACKET

Famous waterproof Gore-Tex® soft shell three-layer fabric with patented fully taped seams provide waterproof, windproof, breathable performance · Backpack friendly design eliminates bulk and weight and provides easy access to pockets · Duplex handwarmer pockets feature upper and lower sections separated by internal zipper · Lightweight laminated tricot cuffs with molded hook and loop adjustment tabs · Roll-away hood is constructed from Gore-Tex Paclite® fabric for compact protection · Zip side vents · Water-resistant zippers · Inside security pocket with zipper closure · Bottom drawcord adjusts from inside pockets · Contrasting side stripe · Sizes: S-3XL · Weight: 2 lb. · Center Back Length (L) 30"

NUMBER	DESCRIPTION		SUGG. RETAIL
30498814	Mossy Oak New Break-Up	S-XL	\$374.00
		2XL-3XL	402.00

D ▶ 30498818	Mossy Oak Treestand	S-XL	374.00
		2XL-3XL	402.00

QUEST GORE-TEX® SOFT SHELL PANT

Famous waterproof Gore-Tex® soft shell three-layer fabric with patented fully taped seams provide waterproof, windproof, breathable performance · Differential cut waistband is higher in the back to prevent drafts when sitting · Belt loops · Zippered fly · Two front pockets, two zippered cargo pockets and one rear pocket · Zip-to-knee cuff openings · Padded, articulated knees · Sizes: S-3XL · Weight: 1 lb. · Center Back Length (L) 28"

NUMBER	DESCRIPTION		SUGG. RETAIL
E ▶ 30298914	Mossy Oak New Break-Up	S-XL	\$337.00
		2XL-3XL	362.00

30298918	Mossy Oak Treestand	S-XL	337.00
		2XL-3XL	362.00

QUEST GORE-TEX® GLOVES WITH X-TRAFIT PRODUCT TECHNOLOGY

100% waterproof, windproof, breathable Gore-Tex® fabric · X-TraFit® Product Technology provides unmatched feel, uncompromising grip and dexterity · Waterproof leather/synthetic palm · Articulated fingers · Sensi-Flex Technology trigger finger for unequalled feel · Sizes: S-XL

NUMBER	DESCRIPTION		SUGG. RETAIL
F ▶ 30787314	Mossy Oak New Break-Up	S-XL	\$74.00

30787318	Mossy Oak Treestand	S-XL	74.00
----------	---------------------	------	-------



TRANSITIONS®
base · insulation · protection



PURSUIT™ — PURSUING PERFECTION.

Pursuit combines the water and wind resistance, unsurpassed breathability and four-way stretch of soft shell fabric with a warm Sherpa™ fleece lining. This remarkable fabrication provides rugged durability and protection in most conditions you hunt in. OdorSmart™ anti-microbial treatment keeps human scent to a minimum. The form-fitting jacket minimizes bulk and weight and is backpack friendly, allowing you to access the pockets when wearing a pack. Padded, articulated knees on the pant make it ideal for stalking game.



NEW LOWER PRICE FOR 2010

A ► Jacket
New Break-Up®



C ► Gloves
New Break-Up®



NEW LOWER PRICE FOR 2010

B ► Pant
Treestand®

PURSUIT™

PURSUIT SOFT SHELL JACKET

Bonded two-layer soft shell fabric is rugged, water- and wind-resistant · Backpack friendly design eliminates bulk and weight and provides easy access to pockets · Warm Sherpa lining with OdorSmart™ anti-bacterial treatment · Fully lined sleeves · Internal cuffs · Duplex handwarmer pockets · Detachable hood · Water-resistant zippers · Inside security pocket with zipper closure · Bottom drawcord adjusts inside pockets · Contrasting side stripe · Sizes: S-3XL · Weight: 2 lb. 2 oz. · Center Back Length (L) 28"

NUMBER	DESCRIPTION	SUGG. RETAIL
A ► 30499014	Mossy Oak New Break-Up	S-XL \$180.00
		2XL-3XL 192.00
30499018	Mossy Oak Treestand	S-XL 180.00
		2XL-3XL 192.00

PURSUIT SOFT SHELL PANT

Bonded two-layer soft shell fabric is rugged, water- and wind-resistant and highly stretchable · Differential cut waistband is higher in the back to prevent drafts when sitting · Warm Sherpa lining with OdorSmart™ anti-bacterial treatment · Belt loops · Zippered fly · Two front pockets, two zippered cargo pockets and one rear pocket · Padded, articulated knees · Zip-to-knee cuff openings with zippered storm flaps · Sizes: S-3XL

NUMBER	DESCRIPTION	SUGG. RETAIL
30299114	Mossy Oak New Break-Up	S-XL \$148.00
		2XL-3XL 158.00
B ► 30299118	Mossy Oak Treestand	S-XL 148.00
		2XL-3XL 158.00

PURSUIT SOFT SHELL GLOVES

Lycra® trigger finger · Bonded two-layer soft shell fabric is rugged, water- and wind-resistant · No-slip palm · Sizes: S-XL

NUMBER	DESCRIPTION	SUGG. RETAIL
C ► 30789214	Mossy Oak New Break-Up	S-XL \$36.00
		30789218 Mossy Oak Treestand S-XL 36.00

ESCAPE™



TRANSITIONS®
base · insulation · protection

ESCAPE™ — PROVEN PROTECTION FROM THE ELEMENTS.

A chill wind steals away your body heat fast, and being damp from perspiration compounds the problem. The Escape Windstopper® technical fleece jacket and pant solve both problems by being totally windproof and extremely breathable, keeping you dry and warm. This remarkable three-layer fabric features a Windstopper membrane between an outer layer of quiet but rugged knit, and an insulating fleece layer on the inside.



F ▶ *Gloves
New Break-Up®*



D ▶ *Jacket
Treestand®*



E ▶ *Pant
New Break-Up®*

ESCAPE WINDSTOPPER JACKET

Windstopper® fabric offers 100% windproof, breathable protection · Fleece lining provides warmth · Backpack friendly design eliminates bulk and weight and provides access to pockets · Fully lined sleeves · Duplex handwarmer pockets · Inside security pocket with zipper closure · Bottom drawcord adjusts inside pockets · Contrasting side stripe · Sizes: S-3XL · Weight: 1 lb. 6 oz. · Center Back Length (L) 29"

NUMBER	DESCRIPTION	SUGG. RETAIL
30499214	Mossy Oak New Break-Up	S-XL \$218.00
		2XL-3XL 234.00
D ▶ 30499218	Mossy Oak Treestand	S-XL 218.00
		2XL-3XL 234.00

ESCAPE WINDSTOPPER PANT

Windstopper® fabric offers 100% windproof, breathable protection · Fleece lining provides warmth · Padded articulated knees · Elasticized waist with belt loops, drawcord and zippered fly · Two front pockets with internal pocket bag · Open cuff with zip-to-knee cuff zippers · Sizes: S-3XL

NUMBER	DESCRIPTION	SUGG. RETAIL
E ▶ 30299314	Mossy Oak New Break-Up	S-XL \$176.00
		2XL-3XL 190.00
30299318	Mossy Oak Treestand	S-XL 176.00
		2XL-3XL 190.00

ESCAPE WINDSTOPPER GLOVES

Windproof, breathable Gore-Tex® Windstopper® insert · Lycra® trigger finger · Bonded two-layer soft-shell fabric is rugged, water- and wind-resistant · No-slip palm · Sizes: S-XL

NUMBER	DESCRIPTION	SUGG. RETAIL
F ▶ 30789314	Mossy Oak New Break-Up	S-XL \$46.00
		30789318 Mossy Oak Treestand S-XL 46.00



TRANSITIONS®
base · insulation · protection



ZERO GRAVITY™ — ULTRALIGHT PACKABLE PROTECTION.

Zero Gravity rainwear features amazingly lightweight Gore-Tex® Paclite® 2.5 layer fabric, the most breathable of Gore-Tex's technologies. Zero Gravity is so light and compact, you can take it along everywhere, and is perfect for layering over any of the Transitions® Series insulation layers or worn alone in warm, wet weather. Never be caught out in the storm without Zero Gravity.



B ▶ Pant
Treestand®

**GORE-TEX® PACLITE®
SHELL TECHNOLOGY**



A ▶ Jacket
New Break-Up®



ZERO GRAVITY PACLITE JACKET

Famous Gore-Tex® waterproof, windproof, breathable fabric featuring 2.5 layer construction · Backpack friendly design eliminates bulk and weight and provides easy access to pockets · Set-in sleeve design with adjustable, watertight hook and loop cuffs · Adjustable attached hood with drawcord closure and molded brim · Full front closure with WaterGuard™ zipper and chin guard · Two handwarmer pockets with WaterGuard zipper · License tab · Drawcord bottom · Stuffs into included bag · Sizes: S-3XL · Weight: 1 lb. 3 oz. · Center Back Length (L) 29"

NUMBER	DESCRIPTION	SUGG. RETAIL
A ▶ 30499414	Mossy Oak New Break-Up	S-XL \$227.00
		2XL-3XL 248.00
30499418	Mossy Oak Treestand	S-XL 227.00
		2XL-3XL 248.00

ZERO GRAVITY PACLITE PANT

Famous Gore-Tex® waterproof, windproof, breathable fabric featuring 2.5 layer construction · Zip-to-knee cuff with WaterGuard™ waterproof zippers · Elasticized cuffs · Elasticized waist with drawcord and belt loops · One rear security pocket with hook and loop closure · Stuffs into included bag · Sizes: S-3XL

NUMBER	DESCRIPTION	SUGG. RETAIL
30299514	Mossy Oak New Break-Up	S-XL \$167.00
		2XL-3XL 186.00
B ▶ 30299518	Mossy Oak Treestand	S-XL 167.00
		2XL-3XL 186.00

TRANSITIONS WATERFOWL. THE ULTIMATE SYSTEM FOR WATERFOWL HUNTERS.



TRANSITIONS®
base · insulation · protection



The TRANSITIONS Waterfowl Series is the best way to stay dry and comfortable in the coldest, nastiest weather you hunt in. Transitions' easy to understand, three-tier layering system makes it easy to get the most out of this time-honored idea, and is tailored to the specific needs of waterfowl hunters.

Unlike other manufacturers, we do more than simply put a marsh-style camo pattern on a big game jacket and market it to waterfowlers. We take advantage of the very latest fabric technology and our own testers to maximize the performance of technical outerwear. From the generous fit, to the seam locations, to the fabrics themselves, Browning waterfowl gear is built to allow an unrestricted swing on fast-moving birds. Gone are bulky insulating layers and stiff, heavy fabrics, all replaced with modern fabrics that offer the ultimate performance with the least amount of weight. Trusted Gore-Tex® fabrications are guaranteed to keep you warm and dry in the coldest, wettest environments.

No matter what the weather: Warm and humid, cold and rainy or anything in between, Transitions will get the job done.

**THIS MAXUS GORE-TEX® JACKET (SEE PAGE 187)
FEATURING REVOLUTIONARY COMFORT MAPPING TECHNOLOGY
IS JUST ONE OF MANY TRANSITIONS SERIES GARMENTS
AVAILABLE IN MOSSY OAK® DUCK BLIND®**





TRANSITIONS®
base · insulation · protection



ENDURANCE FLEECE™. COMFORT OVER THE LONG HAUL.

Comfort and warmth starts with the right foundation. Base Layer fleece garments maximize warmth with minimum bulk for superior freedom of movement even under a heavier, weather-resistant shell. Endurance Fleece fits this description perfectly. The stretchy material moves easily for unrestricted mobility and protection from the cold. Comfort Fleece uses a traditional 200 gram fleece for a familiar feel and trusted performance.



A ▶ Pullover Duck Blind®

B ▶ Pant Duck Blind®

Brownstone



C ▶ Shirt Duck Blind®

D ▶ Pant Duck Blind®

ENDURANCE FLEECE ¼ ZIP PULLOVER

Flexible polyester fleece fabric offers wide range of stretch and comfort · Warm, soft fleece inside, with a smooth jersey face outer · Quarter-zip front with stand-up collar and chin guard · Lycra® binding cuffs and waistband · Welded front pocket with zippered opening · Sizes: S-3XL

NUMBER	DESCRIPTION	SUGG. RETAIL
A ▶ 30118917	Mossy Oak Duck Blind	S-XL \$61.00 2XL-3XL 68.00
30118928	Brownstone	S-XL 49.00 2XL-3XL 55.00

ENDURANCE FLEECE WADER PANT

Flexible polyester fleece fabric offers wide range of stretch and comfort · Warm, soft fleece inside with a smooth jersey face outer · Generous cut · Elastic waistband · Zippered fly · Tapered leg · Elastic stirrups prevent riding up under waders · Sizes: S-3XL

NUMBER	DESCRIPTION	SUGG. RETAIL
B ▶ 30218917	Mossy Oak Duck Blind	S-XL \$61.00 2XL-3XL 68.00

COMFORT FLEECE SHIRT

Lightweight 200 gram fleece is brushed on both sides for additional warmth and comfort · Generous cut · Mock neck design · Sizes: S-3XL

NUMBER	DESCRIPTION	SUGG. RETAIL
C ▶ 30111817	Mossy Oak Duck Blind	S-XL \$38.00 2XL-3XL 45.00

COMFORT FLEECE PANT

Lightweight 200 gram fleece is brushed on both sides for additional warmth and comfort · Generous cut · Tapered leg · Elastic waistband · Elastic stirrups · Zippered fly · Sizes: S-3XL

NUMBER	DESCRIPTION	SUGG. RETAIL
D ▶ 30211817	Mossy Oak Duck Blind	S-XL \$45.00 2XL-3XL 51.00



E ▶ Jacket
Duck Blind®



TRANSITIONS®
base · insulation · protection

4X MICROFLEECE™ — THE RIGHT FLEECE.

4X Microfleece is ideal for nearly all hunting situations. Under fair skies, in warmer temperatures, 4X adds just the right amount of insulation and wind protection. When layered underneath a waterproof parka, it offers excellent insulating performance with minimum bulk that won't affect your range of motion when swinging on fast-moving birds.



F ▶ Vest
Duck Blind®



4X MICROFLEECE JACKET

Highly constructed microfiber fabric is wind-resistant and extremely quiet · Backpack friendly design eliminates bulk and weight and provides easy access to pockets · Duplex handwarmer pockets feature upper and lower sections separated by internal zipper · Set-in sleeves are fully lined for easy on/off and feature Lycra® cuff opening · Two zippered handwarmer pockets and internal zippered security pocket · Contrasting side stripe · Sizes: S-3XL · Weight: 1 lb. 4 oz. · Center Back Length (L) 28"

NUMBER	DESCRIPTION	SUGG. RETAIL
E ▶ 30479017	Mossy Oak Duck Blind	S-XL \$112.00 2XL-3XL 125.00

4X MICROFLEECE VEST

Highly constructed microfiber fabric is wind-resistant and extremely quiet · Duplex handwarmer pockets feature upper and lower sections separated by internal zipper · Two zippered handwarmer pockets and internal zippered security pocket · Contrasting side stripe · Sizes: S-3XL · Weight: 1 lb. · Center Back Length (L) 28"

NUMBER	DESCRIPTION	SUGG. RETAIL
F ▶ 30579117	Mossy Oak Duck Blind	S-XL \$87.00 2XL-3XL 100.00





TRANSITIONS®
base · insulation · protection



A ► Jacket
Duck Blind®



700
FILL POWER™



B ► Vest
Duck Blind®

700 FILL POWER DOWN JACKET

700 fill power goose down insulation provides maximum warmth with minimal weight and bulk · Backpack friendly design provides easy access to pockets · Lycra® cuff and hem · Contrasting side stripe · Stuffs into internal pocket · Sizes: S-3XL · Weight: 1 lb. 4 oz. · Center Back Length (L) 28"

NUMBER	DESCRIPTION		SUGG. RETAIL
A ► 30476617	Mossy Oak Duck Blind	S-XL	\$148.00
		2XL-3XL	160.00

700 FILL POWER DOWN VEST

700 fill power goose down insulation provides maximum warmth with minimal weight and bulk · Backpack friendly design provides easy access to pockets · Lycra® hem · Contrasting side stripe · Stuffs into internal pocket · Sizes: S-3XL · Weight: 15 oz. · Center Back Length (LG) 28"

NUMBER	DESCRIPTION		SUGG. RETAIL
B ► 30576717	Mossy Oak Duck Blind	S-XL	\$123.00
		2XL-3XL	134.00

700 FILL POWER DOWN — NATURE'S INSULATION.

For pure warmth nothing beats goose down. We select only the finest 700 fill power goose down because it provides optimum loft and warmth with minimal weight. The shell is a high thread count, down-proof fabric that maintains both loft and compactness. No coatings or laminations are added for maximum breathability. Down garments function well as insulation layer garments, easily compressing to comfortably wear under a waterproof parka for maximum warmth and protection, and are great when used alone as outerwear in cold, windy, dry weather.

MAXUS®



TRANSITIONS®
base · insulation · protection



MAXUS™ GORE-TEX® JACKET WITH COMFORT MAPPING TECHNOLOGY.

The Maxus Jacket is the most advanced waterfowl protection available. It brings the latest developments in design and technology to satisfy demanding waterfowl hunters. Utilizing Gore-Tex® "Comfort Mapping" technology to break-down the human body into different climatic zones, the Maxus Jacket greatly improves comfort and performance by strategically placing different Gore-Tex fabrics in specific locations to maximize mobility, breathability and protection from the elements. Rugged, warm Gore-Tex soft shell fabric is placed in areas requiring more protection such as the shoulders. Lightweight Paclite® fabric is used in the lower torso and under the arms where less weight and bulk are preferred and flexibility must be maximized. Both soft shell and Paclite are constructed from a revolutionary low shine nylon fabric for more realistic camo print quality and improved concealment. Add a host of extra features and the end result is a garment that revolutionizes comfort and protection in the marsh.

GORE-TEX® PERFORMANCE SHELL TECHNOLOGY

▶ Jacket Duck Blind®

○ DETACHABLE HOOD

○ CALL POCKET

○ UPPER HAND WARMER POCKETS

○ "COMFORT MAPPING" CONSTRUCTION

○ FREEDOM SLEEVE DESIGN

○ LAMINATED WATERTIGHT CUFF

○ BOTTOM DRAWCORD

○ OVER-SIZED LOWER POCKETS WITH HOOK AND LOOP SECURED FLAPS

MAXUS GORE-TEX® JACKET

Gore-Tex® fabric is 100% waterproof, windproof and breathable · Comfort Mapping construction utilizes Gore-Tex three-layer soft shell fabric in the upper body and Gore-Tex Paclite® fabric in the lower body and under the sleeves to maximize comfort and mobility · Detachable hood · Bottom drawcord adjusts from inside lower handwarmer pockets · Call pocket on the left chest with zipper closure · Articulated elbow and freedom sleeve design · Two upper hand warmer pockets with zipper closures · Two lower bellows pockets with hook and loop secured pocket flaps · Inside security pocket with zipper closure · License tab · Sizes: S-3XL · Weight: 1 lb. 13 oz. · Center Back Length (L) 30"

NUMBER	DESCRIPTION	SUGG. RETAIL
▶ 30453717	Mossy Oak Duck Blind	S-XL \$388.00 2XL-3XL 415.00



TRANSITIONS®
base · insulation · protection



**GORE-TEX® PACLITE®
LIGHTWEIGHT, HEAVY PROTECTION.**

Waterfowl weather can turn nasty at the drop of a hat, but you will be ready with an ultralight Gore-Tex® Paclite® Pullover. Utilizing a new lightweight nylon with low shine for better print quality and improved concealment, Gore-Tex Paclite provides protection that is so light it goes unnoticed until needed, yet it still carries the famous Gore-Tex “Guaranteed To Keep You Dry” promise. The half-zip pullover design with attached hood is cut full to layer over heavy insulated clothing. It slips on fast and comes off just as easily when the storm passes.

**GORE-TEX® PACLITE®
SHELL TECHNOLOGY**



The Paclite® pullover stuffs into an included bag.



A ► Half-Zip Pullover Duck Blind®



B ► X-traFit® Gloves Duck Blind®



C ► Decoy Gloves Duck Blind®



GORE-TEX® PACLITE® HALF-ZIP PULLOVER

Gore-Tex® Paclite® fabric · Half-zip pullover design · Upper call pocket with zipper closure · Adjustable attached hood with drawcord closure and molded brim · Half front closure with WaterGuard™ zipper and chin guard · Zippered, double entry lower pouch pocket keeps hands dry, warm and ready for fast action · Elasticized call holder keeps calls available yet out of the way · WaterGuard zipper · License tab · Drawcord bottom · Stuffs into included bag · Sizes: S-3XL · Weight: 1 lb. 4 oz. · Center Back Length (L) 32"

NUMBER	DESCRIPTION	SUGG. RETAIL
A ► 30456517	Mossy Oak Duck Blind	S-XL \$228.00 2XL-3XL 248.00

GORE-TEX® GLOVES WITH X-TRAFIT® PRODUCT TECHNOLOGY

100% waterproof, windproof, breathable Gore-Tex® fabric gloves · X-TraFit® Product Technology provides unmatched feel, uncompromising grip and dexterity · Hook and loop wrist adjustment tab · Dual waterproof leather/synthetic palm · Articulated fingers · Sensi-Flex Technology trigger finger offers unequalled feel · Sizes: S-XL

NUMBER	DESCRIPTION	SUGG. RETAIL
B ► 30787217	Mossy Oak Duck Blind	S-XL \$74.00

GORE-TEX® DECOY GLOVES

100% waterproof, windproof, breathable Gore-Tex® fabric · Extended elbow-length gauntlet is ideal for setting and picking-up decoys · One-hand adjustable forearm closure · Hook and loop wrist adjustment tab · Dual waterproof leather/synthetic palm provides uncompromising grip and dexterity · Articulated fingers · Sensi-Flex Technology trigger finger for unequalled feel · Sizes: S-XL

NUMBER	DESCRIPTION	SUGG. RETAIL
C ► 30787117	Mossy Oak Duck Blind	S-XL \$74.00



Heating System

ADDHEAT.™

The days of heavy battery packs, clumsy controllers and short battery life are over. Heated clothing technology for avid hunters has come of age with the AddHeat system.

The AddHeat system is available in four different Browning garments. In the vest, the heating element is strategically placed in the upper back where it maintains core body temperature. In the jacket and parkas, the heating elements are located in the lower handwarmer pockets to provide warmth to your hands and fingers.

The AddHeat system is made up of a flexible, lightweight, washable heating element found in the garment and the AddHeat Power Pack. The Power Pack includes a compact, rechargeable Li-ion battery that provides up to 5.5 hours of continuous body-warming heat, a simple to use "intelligent" Micro-CPU controller and 110-220V AC charger. The system is conveniently recharged with either a 110-220V AC charger or with an optional 12V DC vehicle charger. Additional batteries are available for longer stays afield. The battery weighs a mere 4.23 ounces and can be recharged up to 500 times.

Care of an AddHeat garment is simple. Just remove the battery and controller, hand wash and line dry the garment as often as necessary. No worries and no hassle.

Note that the Power Pack is not included with AddHeat garments and must be purchased separately. This allows you to purchase a single Power Pack to use with multiple AddHeat garments without having a separate AddHeat System for each. Long waits in tree stands and duck blinds just became more bearable with the added comfort and convenience of AddHeat.

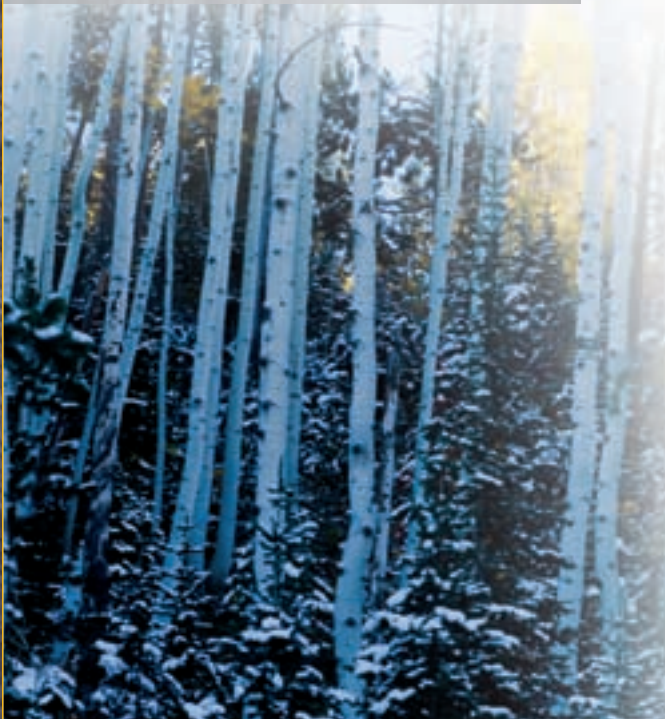

A ▶ Vest, Olive

THE HEATING ELEMENT IS LOCATED IN THE UPPER BACK AREA OF THE VEST TO MAINTAIN CORE BODY TEMPERATURE (THE HEATING ELEMENTS IN THE JACKET AND PARKAS ARE LOCATED IN THE LOWER HANDWARMER POCKETS)

LOOK FOR THESE ADDHEAT MODELS:

XPO BIG GAME INSULATED PARKA, PAGE 190

HELL'S CANYON JACKET, PAGE 193



B ▶ Power Pack



C ▶ 12 Volt Charger (optional)



ADDHEAT VEST

Soft, quiet fleece outer shell · Brushed tricot inner lining · Bottom drawcord · Flexible heating elements can be washed · Stand-up, zip-through collar · **AddHeat Power Pack sold separately, See below** · Sizes: S-3XL · Weight: 2 lb. · Center Back Length (L) 30"

NUMBER	DESCRIPTION	SUGG. RETAIL
A ▶ 30576942	AddHeat Vest, Olive	S-XL \$100.00 2XL-3XL 114.00

ADDHEAT POWER PACK

Power Pack consists of rechargeable Li-ion battery · Intelligent micro-CPU controller maximizes battery life · Four temperature settings (preheat, low, medium, high) · 110-220V AC charger · **Not included with AddHeat garments**

NUMBER	DESCRIPTION	SUGG. RETAIL
B ▶ 121016	AddHeat Power Pack	\$85.00

ADDHEAT 12 VOLT VEHICLE CHARGER

Allows the battery to be charged from a vehicle

NUMBER	DESCRIPTION	SUGG. RETAIL
C ▶ 121017	AddHeat 12 Volt Charger	\$16.00

ADDHEAT EXTRA BATTERY

Compact, long-lasting 7.4V Li-ion battery · Lightweight at only 4.23 ounces · Lasts over 500 recharging cycles

NUMBER	DESCRIPTION	SUGG. RETAIL
121018	AddHeat Battery (not shown)	\$50.00

XPO BIG GAME 4-IN-1 PARKA

Shell: XPO Big Game fabric with Pre-Vent® waterproof, windproof, breathable laminate · Lining has mesh in upper body and nylon taffeta in lower body and arms · Set-in sleeves with one piece, no-seam construction · Articulated elbow for ease of movement · Watertight neoprene cuff with hook and loop tab · Two bellows pockets with the Pocket Expander System and handwarmer pockets · Pocket on left chest to accommodate Browning's Gear "Trievers" System · One inside security pocket with zipper closure · Internal waist drawcord · Detachable hood with molded visor, height adjustment drawcord and two button front closure · Two-way front closure with inner and outer storm flaps secured by five snaps · License tab in back · X-Change System compatible. **Liner:** Quiet camo shell fabric · Thermolite® insulation · Solid color nylon taffeta lining · Reversible design · Set-in sleeves · Two pockets on each side · Elasticized waist · Rib knit cuffs · Sizes: S-3XL

NUMBER	DESCRIPTION	SUGG. RETAIL
30369220	NEW Mossy Oak Break-Up Infinity	S-XL \$263.00 2XL-3XL 291.00
A ▶ 30369214	Mossy Oak New Break-Up	S-XL 263.00 2XL-3XL 291.00
30369218	Mossy Oak Treestand	S-XL 263.00 2XL-3XL 291.00



A ▶ 4-in-1 Parka
New Break-Up®



NEW

NEW FOR 2010

All items on this page are also available in Mossy Oak Break-Up Infinity camo.

B ▶ Insulated Parka
Treestand®



XPO BIG GAME INSULATED PARKA

XPO Big Game fabric with Pre-Vent® waterproof, windproof, breathable laminate · Warm Thermolite® insulation throughout · Brushed tricot lining · Set-in sleeves with one piece, no-seam construction · Articulated elbow for ease of movement · Watertight neoprene cuffs with hook and loop closure · Two bellows pockets with the Pocket Expander System and handwarmer pockets · Pocket on left chest to accommodate Browning's Gear "Trievers" System · One inside security pocket with zipper closure · Adjustable internal bottom drawcord · Detachable hood with molded visor, height adjustment drawcord and two button front closure · Two-way front zipper closure with inner and outer storm flaps secured by five snaps · License tab in back · Sizes: S-3XL · AddHeat electric heating system compatible models available (AddHeat Power Pack sold separately, see page 189)

NUMBER	DESCRIPTION	SUGG. RETAIL
30368820	NEW Mossy Oak Break-Up Infinity	S-XL \$207.00 2XL-3XL 230.00
30368814	Mossy Oak New Break-Up	S-XL 207.00 2XL-3XL 230.00
30368816	Mossy Oak Brush	S-XL 207.00 2XL-3XL 230.00
B ▶ 30368818	Mossy Oak Treestand	S-XL 207.00 2XL-3XL 230.00
30368814H	AddHeat System New Break-Up	S-XL 264.00 2XL-3XL 290.00
30368818H	AddHeat System Treestand	S-XL 264.00 2XL-3XL 290.00

XPO BIG GAME X-CHANGE JACKET

XPO Big Game fabric with Pre-Vent® waterproof, windproof, breathable laminate · Lining has mesh in upper body and brushed tricot in lower body and sleeves · Set-in sleeves with one piece, no-seam construction · Articulated elbow for ease of movement · Watertight neoprene cuffs with hook and loop closure · Two handwarmer pockets with zippered closure · Pocket on left chest to accommodate Browning's Gear "Trievers" System · One inside security pocket with zipper closure · Bottom drawcord that adjusts from inside handwarmer pockets · Detachable hood with molded visor, height adjustment drawcord and two button front closure · Two-way front zipper closure with inner and outer storm flaps secured by five snaps · License tab in back · X-Change System compatible · Sizes: S-3XL

NUMBER	DESCRIPTION	SUGG. RETAIL
30469320	NEW Mossy Oak Break-Up Infinity	S-XL \$180.00 2XL-3XL 200.00
30469314	Mossy Oak New Break-Up	S-XL 180.00 2XL-3XL 200.00
C ▶ 30469316	Mossy Oak Brush	S-XL 180.00 2XL-3XL 200.00
30469318	Mossy Oak Treestand	S-XL 180.00 2XL-3XL 200.00

C ▶ X-Change Jacket
Brush®



XPO BIG GAME PANT

XPO Big Game fabric with Pre-Vent® waterproof, windproof, breathable laminate
 · Brushed tricot lining · Differential cut waistband is higher in the back to prevent drafts when sitting · Grip strip waistband with suspender buttons · Belt loops · Zippered fly
 · Two front pockets, two zippered cargo pockets and one rear pocket · Zip-to-knee cuff openings with storm flaps · Sizes: S-3XL

NUMBER	DESCRIPTION	SUGG. RETAIL
30269620	NEW Mossy Oak Break-Up Infinity	S-XL \$127.00 2XL-3XL 140.00
30269614	Mossy Oak New Break-Up	S-XL 127.00 2XL-3XL 140.00
D ▶ 30269616	Mossy Oak Brush	S-XL 127.00 2XL-3XL 140.00
30269618	Mossy Oak Treestand	S-XL 127.00 2XL-3XL 140.00

XPO BIG GAME INSULATED BIB

XPO Big Game fabric with Pre-Vent® waterproof, windproof, breathable laminate
 · Brushed tricot lining · Full-length, side seam two-way zippers with storm flaps · Rib knit side vent gussets · Elasticized suspenders with cam lock buckle · Rear zippered pocket
 · Zippered front opening with two-way zipper and storm flap · Thermolite® insulation
 · Sizes: S-3XL

NUMBER	DESCRIPTION	SUGG. RETAIL
30669420	NEW Mossy Oak Break-Up Infinity	S-XL \$168.00 2XL-3XL 188.00
30669414	Mossy Oak New Break-Up	S-XL 168.00 2XL-3XL 188.00
E ▶ 30669418	Mossy Oak Treestand	S-XL 168.00 2XL-3XL 188.00

XPO BIG GAME GLOVES

XPO Big Game fabric with Pre-Vent® insert · No-slip palm · Fully insulated · Sizes: S-XL

NUMBER	DESCRIPTION	SUGG. RETAIL
30787020	NEW Mossy Oak Break-Up Infinity	S-XL \$46.00
F ▶ 30787014	Mossy Oak New Break-Up	S-XL 46.00
30787018	Mossy Oak Treestand	S-XL 46.00

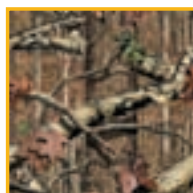

NEW
NEW FOR 2010
 All items on this page are also available in Mossy Oak Break-Up Infinity camo.



D ▶ Pant Brush®



E ▶ Insulated Bib Treestand®



F ▶ Gloves New Break-Up®



XPO™ — EXCEPTIONAL COMFORT AND PERFORMANCE.

Rely on Browning XPO (eXtended Performance Outerwear). It is designed to be tough, comfortable and functional in all types of weather conditions. XPO features Pre-Vent®, a waterproof, windproof, breathable laminate that ensures protection from the most severe conditions Mother Nature can send, yet remains breathable to let perspiration escape. Importantly, Pre-Vent does all this at a very competitive price, without skimping on other features that matter like abundant pockets, quality zippers and rugged construction.



NEW

NEW FOR 2010

All items on this page are also available in Mossy Oak Break-Up Infinity camo.



XPO™ FOR HER/XPO™ JUNIOR OUTDOOR WEAR FOR YOUR WHOLE FAMILY.

Now every member of your family can enjoy the same warm, dry experience in the field with XPO For Her and XPO Junior outerwear. XPO For Her and XPO Junior addresses the distinct size differences between men, women and kids to maximize comfort, warmth and mobility without the performance downgrades common in the other makers' hunting clothes. Make the outdoors more comfortable and more fun for everyone with XPO For Her and XPO Junior.

B ► For Her Bib
New Break-Up®

XPO FOR HER BIG GAME JACKET

XPO Big Game fabric with Pre-Vent® waterproof, windproof, breathable laminate · Specifically cut and designed for women · Insulated for warmth without bulk · Adjustable hood · Differential cut · Front wind flap · Two zippered bellows pockets plus inside security pocket · Adjustable Lycra® cuffs · Drawcord waist · Quiet, direct-attach zipper pulls · Sizes: S-XL

NUMBER	DESCRIPTION	SUGG. RETAIL
30460720	NEW Mossy Oak Break-Up Infinity	S-XL \$172.00

A ►	30460714 Mossy Oak New Break-Up	S-XL 172.00
------------	---------------------------------	-------------

XPO FOR HER BIG GAME BIB

XPO Big Game fabric with Pre-Vent® waterproof, windproof, breathable laminate · Specifically cut and designed for women · Insulated for warmth without bulk · Two handwarmer pockets · Knit side gussets · Full-length front zipper Full-length leg zippers · Zippered rear pocket · Sizes: S-XL

NUMBER	DESCRIPTION	SUGG. RETAIL
30660820	NEW Mossy Oak Break-Up Infinity	S-XL \$132.00

B ►	30660814 Mossy Oak New Break-Up	S-XL 132.00
------------	---------------------------------	-------------

XPO JUNIOR BIG GAME PARKA

XPO Big Game fabric with Pre-Vent® waterproof, windproof, breathable laminate · Cut specifically for junior builds · Insulated for superior warmth · Adjustable hood · Differential cut is longer in the back to prevent drafts when sitting · Front wind flap · Two zippered bellows pockets plus inside security pocket · Adjustable cuffs · Quiet, direct-attach zipper pulls · Sizes: S (6-8), M (10-12), L (14-16), XL (18-20)

NUMBER	DESCRIPTION	SUGG. RETAIL
30367320	NEW Mossy Oak Break-Up Infinity	S-XL \$110.00

C ►	30367314 Mossy Oak New Break-Up	S-XL 110.00
------------	---------------------------------	-------------

XPO JUNIOR BIG GAME PANT

XPO Big Game fabric with Pre-Vent® waterproof, windproof, breathable laminate · Cut specifically for junior builds · Insulated for superior warmth · Two handwarmer pockets · Knit side gussets · Full-length front zipper · Knee-length leg zippers · Rear pocket · Sizes: S (6-8), M (10-12), L (14-16), XL (18-20)

NUMBER	DESCRIPTION	SUGG. RETAIL
30667420	NEW Mossy Oak Break-Up Infinity	S-XL \$92.00

D ►	30667414 Mossy Oak New Break-Up	S-XL 92.00
------------	---------------------------------	------------

A ► For Her Jacket
New Break-Up®

PRE-VENT

C ► Junior Parka
New Break-Up®

D ► Junior Pant
New Break-Up®



**HELL'S CANYON™
RUGGED OUTERWEAR THE TOUGHEST HUNTS.**

When the going gets tough, the tough reach for Hell's Canyon outerwear. Once you try it on, you'll understand why this rugged line of gear has quickly become a best seller, appreciated for its comfort, features and durability. The three-layer construction starts with an abrasion-resistant fleece outer shell that is almost silent in the brush. Next is a windproof, breathable and highly water-resistant membrane to combat the elements. Finally, a soft OdorSmart™ fleece lining provides warmth, controls human odor and wicks away perspiration. This three-layer fabric covers all the bases in a single lightweight, comfortable garment that easily goes the distance.



E ▶ Parka
New Break-Up®



F ▶ Jacket
Treestand®

HELL'S CANYON PARKA

Rugged three-layer fabric is silent in brush, windproof, breathable and highly water-resistant · OdorSmart™ anti-microbial, moisture wicking fleece lining · Full-length front zipper with internal storm flap · Zippered cargo pockets and ventilator pockets with storm flaps · Bottom drawcord · Adjustable neoprene cuffs · Sizes: S-3XL

NUMBER	DESCRIPTION	SUGG. RETAIL
E ▶ 30381314	Mossy Oak New Break-Up	S-XL \$150.00 2XL-3XL 162.00
30381318	Mossy Oak Treestand	S-XL 150.00 2XL-3XL 162.00

HELL'S CANYON JACKET

Rugged three-layer fabric is silent in brush, windproof, breathable and highly water-resistant · OdorSmart™ anti-microbial, moisture wicking fleece lining · Full-length front zipper with internal storm flap · Zippered handwarmer pockets · Zippered ventilator chest pockets · Bottom drawcord · Adjustable neoprene cuffs · Sizes: S-3XL · AddHeat electric heating system compatible models available (AddHeat Power Pack sold separately, see page 189)

NUMBER	DESCRIPTION	SUGG. RETAIL
30481420	NEW Mossy Oak Break-Up Infinity	S-XL \$125.00 2XL-3XL 136.00
30481414	Mossy Oak New Break-Up	S-XL 125.00 2XL-3XL 136.00
F ▶ 30481418	Mossy Oak Treestand	S-XL 125.00 2XL-3XL 136.00
30481401	NEW Blaze	S-XL 112.00 2XL-3XL 123.00
30481420R	NEW RMEF Mossy Oak Break-Up Infinity	S-XL 125.00 2XL-3XL 136.00
30481414R	NEW RMEF Mossy Oak New Break-Up	S-XL 125.00 2XL-3XL 136.00
30481418R	NEW RMEF Mossy Oak Treestand	S-XL 125.00 2XL-3XL 136.00
30481401R	NEW RMEF Blaze	S-XL 112.00 2XL-3XL 123.00
30481414H	AddHeat System New Break-Up	S-XL 168.00 2XL-3XL 188.00
30481418H	AddHeat System Treestand	S-XL 168.00 2XL-3XL 188.00



NEW FOR 2010
Also available in Mossy Oak Break-Up Infinity camo.



HELL'S CANYON™ AND THE RMEF.

Elk are incredibly adaptable creatures, able to not only survive, but thrive in rugged, seemingly inhospitable country. Still, without help from conservation organizations like the Rocky Mountain Elk Foundation, these majestic animals and their habitat might face a more uncertain future. With every purchase of Hell's Canyon RMEF clothing, Browning is proud to donate a portion of the proceeds to this noble organization.

HELL'S CANYON VEST

Rugged three-layer fabric is silent in brush, windproof, breathable and highly water-resistant · OdorSmart™ anti-microbial, moisture wicking fleece lining · Full-length front zipper with internal storm flap · Zippered cargo pockets and ventilator pockets with storm flaps · Bottom drawcord · Sizes: S-3XL

NUMBER	DESCRIPTION	SUGG. RETAIL
30581420	NEW Mossy Oak Break-Up Infinity	S-XL \$96.00
		2XL-3XL 108.00
30581414	NEW Mossy Oak New Break-Up	S-XL 96.00
		2XL-3XL 108.00
30581418	NEW Mossy Oak Treestand	S-XL 96.00
		2XL-3XL 108.00
A ▶ 30581401	NEW Blaze	S-XL 88.00 2XL-3XL 98.00
30581420R	NEW RMEF Mossy Oak Break-Up Infinity	S-XL 96.00
		2XL-3XL 108.00
30581414R	NEW RMEF Mossy Oak New Break-Up	S-XL 96.00
		2XL-3XL 108.00
30581418R	NEW RMEF Mossy Oak Treestand	S-XL 96.00
		2XL-3XL 108.00
30581401R	NEW RMEF Blaze	S-XL 88.00
		2XL-3XL 98.00



NEW A ▶ Vest Blaze



HELL'S CANYON PANT

Rugged three-layer fabric is silent in brush, windproof, breathable and highly water-resistant · OdorSmart™ anti-microbial, moisture wicking fleece lining · Differential cut waistband is higher in the back to prevent drafts when sitting · Grip strip waistband with suspender buttons · Belt loops · Zippered fly · Two front pockets, two zippered cargo pockets and one rear pocket · Neoprene cuffs · Sizes: S-3XL

NUMBER	DESCRIPTION	SUGG. RETAIL
30281520	NEW Mossy Oak Break-Up Infinity	S-XL \$136.00
		2XL-3XL 150.00
B ▶ 30281514	NEW Mossy Oak New Break-Up	S-XL 136.00 2XL-3XL 150.00
30281518	NEW Mossy Oak Treestand	S-XL 136.00
		2XL-3XL 150.00
30281501	NEW Blaze	S-XL 123.00
		2XL-3XL 135.00
30281520R	NEW RMEF Mossy Oak Break-Up Infinity	S-XL 136.00
		2XL-3XL 150.00
30281514R	NEW RMEF Mossy Oak New Break-Up	S-XL 136.00
		2XL-3XL 150.00
30281518R	NEW RMEF Mossy Oak Treestand	S-XL 136.00
		2XL-3XL 150.00
30281501R	NEW RMEF Blaze	S-XL 123.00
		2XL-3XL 135.00



B ▶ Pant New Break-Up®

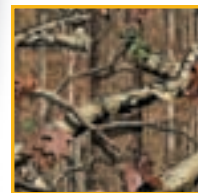

NEW

NEW FOR 2010
All items on this page are also available in Mossy Oak Break-Up Infinity camo.

HELL'S CANYON GLOVES

Rugged three-layer fabric is silent in brush, windproof, extremely breathable and water-resistant · Textured palm and finger overlays · Sizes: S-XL

NUMBER	DESCRIPTION	SUGG. RETAIL
30788820	NEW Mossy Oak Break-Up Infinity	S-XL \$36.00
C ▶ 30788814	NEW Mossy Oak New Break-Up	S-XL 36.00
30788818	NEW Mossy Oak Treestand	S-XL 36.00



C ▶ Glove New Break-Up®

D ▶ Beanie New Break-Up®

NEW

NEW

HELL'S CANYON BEANIE

Power Stretch fabric provides a perfect fit · Stuffs away easily when not in use · Sizes: One size fits most

NUMBER	DESCRIPTION	SUGG. RETAIL
30894120	NEW Mossy Oak Break-Up Infinity	one size \$30.00
D ▶ 30894114	NEW Mossy Oak New Break-Up	one size 30.00



HELL'S CANYON™ FULL THROTTLE.

Lighter weight Full Throttle gear brings a new level of performance to the Hell's Canyon line-up. The new fabric is a two-layer construction featuring a rugged water- and wind-resistant woven outer shell bonded to moisture-wicking OdorSmart™ featherweight fleece on the inside. Because there is no lamination layer, there is less resistance to airflow through the fabric for increased breathability. You will stay dry and comfortable in warmer weather and higher activity levels as perspiration is quickly moved away from your body. Crank up the intensity of your next hunt with Hell's Canyon Full Throttle.

LIGHTWEIGHT 2-LAYER BONDED FABRIC



DRAWCORD BOTTOM

NEW

E ▶ Full Throttle Jacket
New Break-Up®

INTERNAL LYCRA CUFF



HELL'S CANYON FULL THROTTLE JACKET

Woven two-layer bonded fabric is highly water- and wind-resistant and extremely breathable · Lightweight moisture wicking fleece lining with OdorSmart™ anti-microbial technology · Differential cut (longer in the back) · Stand-up, zip-through collar with double-pull closure · On-seam handwarmer pockets · Extra large zippered chest pockets · Bottom drawcord · Sizes: S-3XL

NUMBER	DESCRIPTION	SUGG. RETAIL
30497720	NEW Mossy Oak Break-Up Infinity	S-XL \$107.00 2XL-3XL 118.00
E ▶ 30497714	NEW Mossy Oak New Break-Up	S-XL 107.00 2XL-3XL 118.00
30497718	NEW Mossy Oak Treestand	S-XL 107.00 2XL-3XL 118.00

HELL'S CANYON FULL THROTTLE PANT

Woven two-layer fabric is highly water- and wind-resistant and extremely breathable · Lightweight moisture wicking fleece lining with OdorSmart™ anti-microbial technology · Zip-to-knee cuff openings · Elasticized waist with drawcord and belt loops · Zippered fly · Two front pockets, one zippered rear security pocket · Articulated knee for extra mobility · Sizes: S-3XL

NUMBER	DESCRIPTION	SUGG. RETAIL
30297720	NEW Mossy Oak Break-Up Infinity	S-XL \$107.00 2XL-3XL 118.00
F ▶ 30297714	NEW Mossy Oak New Break-Up	S-XL 107.00 2XL-3XL 118.00
30297718	NEW Mossy Oak Treestand	S-XL 107.00 2XL-3XL 118.00

NEW
F ▶ Full Throttle Pant
New Break-Up®

NEW

NEW FOR 2010
All items on this page are also available in Mossy Oak Break-Up Infinity camo.



WING-SET JACKET.
SOFT SHELL PERFORMANCE FOR THE MARSH.

Weighing in at an ultralight 26 oz., the Wing-Set Soft Shell Jacket provides heavyweight protection. The three-layer fabric combines a rugged nylon outer shell, waterproof, windproof and breathable Pre-Vent® lamination plus a soft inner fleece layer to provide warmth and protection over a broad temperature range. Unlike other soft shell jackets that claim to be waterproof, the Wing-Set jacket truly is, with external taping on every seam. Freedom sleeve construction and articulated elbows allow unrestricted movement to swing and follow through on fast flying birds. Discover how comfortable hunting can be with the light weight, minimal bulk and mega protection of the Wing-Set Jacket.



FREEDOM SHOULDER
 AND ARTICULATED
 ELBOW DESIGN

CALL POCKETS
 ON CHEST

DETACHABLE,
 ADJUSTABLE HOOD

EXTERNALLY TAPED
 SEAMS FOR 100%
 WATERPROOF
 PERFORMANCE

► Wing-Set Jacket
 Duck Blind®

ADJUSTABLE DRAWCORD
 BOTTOM

ADJUSTABLE
 WATER-RESISTANT
 CUFFS



WING-SET JACKET

Lightweight soft shell three-layer fabric features Browning Pre-Vent® waterproof, windproof and breathable laminate · Fully-taped seams · Water-resistant laminated cuffs with hook and loop closures · Freedom shoulder design and articulated elbow for unrestricted movement · Two upper call pockets with zipper closures · Two lower pockets with zipper closures · Detachable hood with drawcord adjustment · Full length front zipper with inner and outer storm flaps · Drawcord bottom adjusts from inside lower pockets · Sizes: S-3XL · Weight: 1 lb. 10 oz. · Center Back Length (L) 30"

NUMBER	DESCRIPTION	SUGG. RETAIL
► 30479417	Mossy Oak Duck Blind	S-XL \$225.00 2XL-3XL 250.00



DETACHABLE, INSULATED, HEIGHT-ADJUSTABLE HOOD

MOLDED SHOULDER STRIPS

ZIP-OUT, REVERSABLE, INSULATED LINER JACKET

XCHANGE SYSTEM

B ▶ 4-in-1 Parka Duck Blind®

TWO-WAY FRONT ZIPPER WITH INTERNAL AND EXTERNAL STORM FLAPS

GEAR 'TRIEVER' SYSTEM POCKETS

SELECTWEIGHT INSULATION SYSTEM

SHELL POCKETS WITH POCKET EXPANDER SYSTEM

NEOPRENE CUFFS

C ▶ Gloves Duck Blind®



XPO GRAND PASSAGE 4-IN-1 PARKA

Shell: XPO Grand Passage fabric with Pre-Vent® waterproof, windproof, breathable laminate · Mesh moisture barrier strip between shell and lining · Set-in sleeves with one-piece, no-seam construction · Articulated elbow for ease of movement · Detachable, insulated, height-adjustable hood · Two oversize, spill-proof bellows pockets with magnetic closures and handwarmer pockets · Shell pockets with the Pocket Expander System · Two Gear 'Trievers'™ System pockets · Two chest handwarmer pockets · Inside security pocket · Two-way front zipper with internal and external storm flaps · Adjustable, watertight neoprene cuffs with hook and loop closure · Molded shoulder strips protect fabric wear from heavy bags · Internal waist drawcord · X-Change System compatible
Liner: Camo fleece reverses to solid-color woven fabric · SelectWeight™ insulation system maximizes warmth and freedom of movement · Set-in sleeves · Elasticized bottom and knit cuffs · Two slash pockets on each side · X-Change System compatible · Sizes: S-3XL

XPO™
XTENDED PERFORMANCE OUTERWEAR



D ▶ Gear 'Trievers'® (calls not included)

NUMBER	DESCRIPTION	SUGG. RETAIL
B ▶ 30398217	Mossy Oak Duck Blind	S-XL \$308.00
		2XL-3XL 330.00

XPO GRAND PASSAGE GLOVES

XPO Grand Passage fabric with Pre-Vent® waterproof, windproof, breathable insert · Improved no-slip palm · Fully insulated · Sizes: S-XL

NUMBER	DESCRIPTION	SUGG. RETAIL
C ▶ 30786917	Mossy Oak Duck Blind	S-XL \$46.00

GEAR 'TRIEVER

No more hanging or dropping calls and accessories · Attaches to jackets, webbing, belts or straps · Retractable cable keeps calls and gear at hand and out of the elements · Call Lanyard model holds up to four calls · Accessory model with a split-ring is ideal for e-collar and decoy remotes, flashlights, etc. · Fits in the chest pockets of some Browning jackets and parkas

NUMBER	DESCRIPTION	SUGG. RETAIL
D ▶	121011 Gear 'Trievers' Duck Call Lanyard	\$29.99
	121012 Gear 'Trievers' Accessory with Split Ring	21.50
	121013 Gear 'Trievers' Lanyard Only	14.00

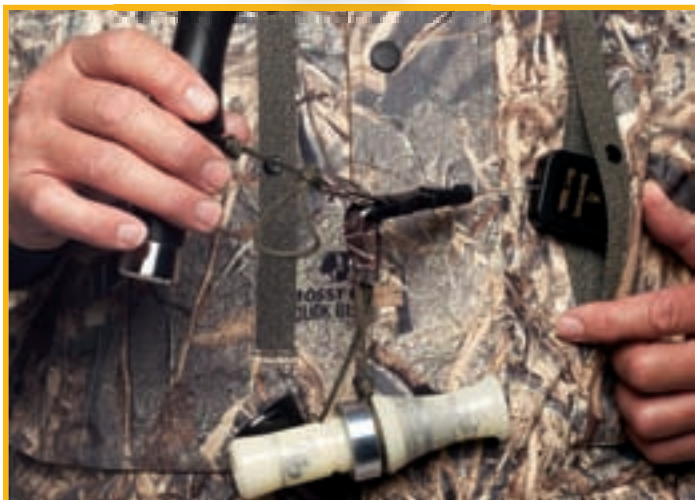



A ▶ Insulated Jacket
Duck Blind®



B ▶ Insulated Bib
Duck Blind®



C ▶ Layout Bib
Duck Blind®

XPO GRAND PASSAGE INSULATED JACKET

XPO Grand Passage fabric with Pre-Vent® waterproof, windproof, breathable laminate · SelectWeight™ insulation system maximizes warmth and freedom of movement · Mesh moisture barrier strip between shell and lining · Soft and warm brushed tricot lining, reversed in sleeves · Set-in sleeves with one-piece, no-seam construction · Articulated elbow for ease of movement · Detachable, insulated, height-adjustable hood · Two oversize, spill-proof bellows pockets with magnetic closures and handwarmer pockets · Shell pockets with the Pocket Expander System · Two Gear “Trierer”™ System pockets · Two chest handwarmer pockets · Inside security pocket · Two-way front zipper with internal and external storm flaps · Adjustable, watertight neoprene cuffs with hook and loop closure · Molded shoulder strips protect fabric wear from heavy bags · Internal waist drawcord · Removable neoprene skirt helps seal out water · Short length is ideal for wading · Sizes: S-3XL

NUMBER	DESCRIPTION	SUGG. RETAIL
A ▶ 30498417	Mossy Oak Duck Blind	S-XL \$227.00 2XL-3XL 252.00

XPO GRAND PASSAGE INSULATED BIB

XPO Grand Passage fabric with Pre-Vent® waterproof, windproof, breathable laminate · Brushed tricot lining · Thermore® insulation · Full-length, two-way side seam zippers with storm flaps · Rib knit side vent gussets · Elasticized suspenders with cam lock buckles · One zippered rear pocket · Two-way zippered front opening storm flap · Sizes: S-3XL

NUMBER	DESCRIPTION	SUGG. RETAIL
B ▶ 30698617	Mossy Oak Duck Blind	S-XL \$170.00 2XL-3XL 190.00

XPO GRAND PASSAGE LAYOUT BIB

XPO Grand Passage fabric with Pre-Vent® waterproof, windproof, breathable laminate · Brushed tricot lining · Non-insulated construction for year around comfort · Double-padded torso area for comfort and warmth while on the ground · Full-length, two-way side seam zippers with storm flaps · Rib knit side vent gussets · Elasticized suspenders with cam lock buckles · Kangaroo-style bellows chest pocket with pass-through handwarmer pocket · Sizes: S-3XL

NUMBER	DESCRIPTION	SUGG. RETAIL
C ▶ 30697417	NEW Mossy Oak Duck Blind	S-XL \$160.00 2XL-3XL 170.00

NEW XPO™ GRAND PASSAGE™ LAYOUT BIB.

The highly-specialized Grand Passage Layout Bib has features specially designed to maximize your comfort in the layout blind. The bib is highlighted by a waterproof, breathable Pre-Vent® laminate and is uninsulated, yet easily layered, for multi-season versatility. The back of the bib is double-padded to increase comfort and protection from ice-cold ground. An oversize bellows pocket on the chest keeps oft needed gear at the ready and a pass-through handwarmer pocket keeps your hands warm and dry.



D ▶ Pullover Duck Blind®



E ▶ Hooded Pullover Duck Blind®



F ▶ Vest Duck Blind®



G ▶ Hooded Vest Duck Blind®

WINDCUTTER WATERFOWL PULLOVER

Waterfowl soft shell 3-layer, 4-way stretch laminated fabric with an abrasion-resistant and highly water-resistant polyester outer face, middle layer is a Windcutter™ laminate that blocks wind and provides water-resistance in all but the most extreme weather, inner layer is a soft fleece · Two chest pockets: one zippered, one magnetic closure · Upper handwarmer pockets are positioned above the wader line · Side panel construction features breathable tricot for a comfortable fit inside waders · Half-length zipper · Stand-up collar · Sizes: S-3XL

NUMBER	DESCRIPTION	SUGG. RETAIL
D ▶ 30022517 Mossy Oak Duck Blind		S-XL \$111.00
		2XL-3XL 123.00

WINDCUTTER WATERFOWL HOODED PULLOVER

Waterfowl soft shell 3-layer, 4-way stretch laminated fabric with an abrasion-resistant and highly water-resistant polyester outer face, middle layer is a Windcutter™ laminate that blocks wind and provides water-resistance in all but the most extreme weather, inner layer is a soft fleece · Two chest pockets: one zippered, one magnetic closure · Upper handwarmer pockets are positioned above the wader line · Side panel construction features breathable tricot for a comfortable fit inside waders · Half-length zipper · Three-piece hood with drawcord · Stand-up collar · Sizes: S-3XL

NUMBER	DESCRIPTION	SUGG. RETAIL
E ▶ 30022617 Mossy Oak Duck Blind		S-XL \$123.00
		2XL-3XL 135.00

WINDCUTTER WATERFOWL VEST

Waterfowl soft shell 3-layer, 4-way stretch laminated fabric with an abrasion-resistant and highly water-resistant polyester outer face, middle layer is a Windcutter™ laminate that blocks wind and provides water-resistance in all but the most extreme weather, inner layer is a soft fleece · Two chest pockets: one zippered, one magnetic closure · Upper handwarmer pockets are positioned above wader line · Side panel construction features breathable tricot for a comfortable fit inside waders · Full-length zipper · Stand-up collar · Sizes: S-3XL

NUMBER	DESCRIPTION	SUGG. RETAIL
F ▶ 30522517 Mossy Oak Duck Blind		S-XL \$85.00
		2XL-3XL 99.00

WINDCUTTER WATERFOWL HOODED VEST

Waterfowl soft shell 3-layer, 4-way stretch laminated fabric with an abrasion-resistant and highly water-resistant polyester outer face, middle layer is a Windcutter™ laminate that blocks wind and provides water-resistance in all but the most extreme weather, inner layer is a soft fleece · Two chest pockets: one zippered, one magnetic closure · Upper handwarmer pockets are positioned above wader line · Side panel construction features breathable tricot for a comfortable fit inside waders · Full-length zipper · Three-piece hood with drawcord · Stand-up collar · Sizes: S-3XL

NUMBER	DESCRIPTION	SUGG. RETAIL
G ▶ 30522617 Mossy Oak Duck Blind		S-XL \$99.00
		2XL-3XL 111.00

A ► Half-Zip Pullover
Duck Blind®



B ► Shirt
Duck Blind®



WARM FRONT™ — WARM WEATHER COMFORT.

Warm Front offers just the right amount of protection when hunting in warmer climates or when temperatures rise in the afternoon. You can depend on Warm Front garments instead of a heavy waterproof shell, even in colder, drier weather by wearing it over insulating layers to stave off the wind.

WARM FRONT HALF-ZIP PULLOVER

Highly breathable, water-resistant polyester fabric offers lightweight protection for warm, clear weather · Stand-up, zip through fleece-lined collar · Low bulk pullover design is comfortable under waders · Small front pocket · Lanyard tab keeps calls out of the way · Warm fleece lining · Sizes: S-3XL

NUMBER	DESCRIPTION	SUGG. RETAIL
A ► 30012617	Mossy Oak Duck Blind	S-3XL \$61.00

WARM FRONT SHIRT

Highly breathable, water-resistant polyester fabric offers lightweight protection for warm, clear weather · Lightweight tricot lining adds warmth without bulk for comfort under waders · Button down collar · Longer sleeve plackets for easy sleeve roll-up · Two chest pockets: one zippered, one magnetic closure · Two upper handwarmer pockets are positioned above the wader line · Sizes: S-3XL

NUMBER	DESCRIPTION	SUGG. RETAIL
B ► 30118717	Mossy Oak Duck Blind	S-XL \$86.00 2XL-3XL 98.00

WARM FRONT WADER PANT

Highly breathable, water-resistant polyester fabric offers lightweight warmth under waders · Lightweight fleece lining adds just the right amount of warmth · Elasticized waist with belt loops · Four pocket style · Leg zippers let pants fit easily over boots and zip down snug against the ankles · Elastic foot stirrups · Sizes: S-2XL

NUMBER	DESCRIPTION	SUGG. RETAIL
C ► 30013017	Mossy Oak Duck Blind	S-2XL \$64.00



C ► Wader Pant
Duck Blind®

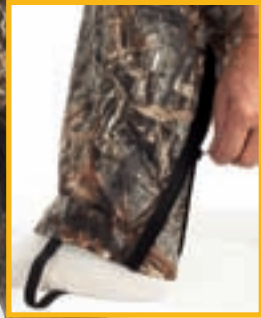



D ▶ Jacket
New Break-Up®

DRY-LITE® — STAY DRY.

Dry-Lite has proven its worth time and again in the field when the weather takes a sudden turn for the worse. Ultra lightweight Pre-Vent® fabric and the simple design make Dry-Lite easy to stow and carry in a pack, golf bag or vehicle and go completely unnoticed until the rain starts to fall or a chill wind starts to blow. Dry-Lite is always ready to provide complete protection.



DRYlite®



E ▶ Pant
Treestand®



DRY-LITE JACKET

High-density tricot with Pre-Vent® waterproof, windproof, breathable fabric · Raglan sleeve construction with adjustable, watertight hook and loop cuffs · Adjustable attached hood with drawcord closure and molded brim · Full front closure with WaterGuard™ zipper and chin guard · Two handwarmer pockets with WaterGuard zipper · License tab · Drawcord bottom · Stuffs into included bag · Dry-Lite Jacket and Pant weigh a combined 1.2 lbs. · Sizes: S-3XL

NUMBER	DESCRIPTION	SUGG. RETAIL	
D ▶ 30467114	Mossy Oak New Break-Up	S-XL	\$150.00
		2XL-3XL	162.00
30467118	Mossy Oak Treestand	S-XL	150.00
		2XL-3XL	162.00

DRY-LITE PANT

High-density tricot with Pre-Vent® waterproof, windproof, breathable fabric · Zip-to-knee cuff with WaterGuard™ waterproof zippers · Elasticized cuffs · Elasticized waist with drawcord and belt loops · One rear security pocket with hook and loop closure · Stuffs into included bag · Dry-Lite Jacket and Pant weigh a combined 1.2 lbs. · Sizes: S-3XL

NUMBER	DESCRIPTION	SUGG. RETAIL	
30267214	Mossy Oak New Break-Up	S-XL	\$100.00
		2XL-3XL	112.00
E ▶ 30267218	Mossy Oak Treestand	S-XL	100.00
		2XL-3XL	112.00





A ▶ Jacket
New Break-Up®



B ▶ Vest
New Break-Up®



C ▶ Pant
New Break-Up®

TF-300 FLEECE JACKET

Midweight fleece with durable, water-repellent Teflon® finish · Full-length front zipper closure · Elasticized cuffs and bottom · Stand-up, zip-through collar · Nylon reinforced collar · Two on-seam handwarmer pockets · X-Change System compatible · Sizes: S-3XL

NUMBER	DESCRIPTION	SUGG. RETAIL
A ▶ 30473014	Mossy Oak New Break-Up	S-XL \$80.00 2XL-3XL 87.00

TF-300 FLEECE VEST

Midweight fleece with durable, water-repellent Teflon® finish · Full-length front zipper closure · Elasticized bottom · Stand-up, zip-through collar · Nylon reinforced collar · Two on-seam handwarmer pockets · X-Change System compatible · Sizes: S-3XL

NUMBER	DESCRIPTION	SUGG. RETAIL
B ▶ 30573114	Mossy Oak New Break-Up	S-XL \$67.00 2XL-3XL 74.00

TF-300 FLEECE PANT

Midweight fleece with durable, water-repellent Teflon® finish · Adjustable elasticized waist · Knit cuffs with side seam leg zippers · Two on-seam pockets · Zippered rear pocket · Sizes: S-3XL

NUMBER	DESCRIPTION	SUGG. RETAIL
C ▶ 30273214	Mossy Oak New Break-Up	S-XL \$67.00 2XL-3XL 74.00

JUNIOR — BIG-TIME WARMTH IN A SMALL SIZE.

Now your little ones can enjoy the warmth and quality of Browning outerwear with stylish TF-300 Fleece and Down Jackets and Vests designed to keep them warm in cold conditions. Kids are the ultimate product testers and tougher on clothes than anyone. Whether sitting in a cold duck blind or waiting at the bus stop, Browning Junior is ready to provide warm, comfortable protection for your little hunting partners.



D ▶ Junior Fleece Jacket
New Break-Up®



E ▶ Junior Fleece Vest
New Break-Up®



F ▶ Junior Down Jacket
New Break-Up®

JUNIOR TF-300 FLEECE JACKET

Midweight fleece with durable, water-repellent Teflon® finish · Cut specifically for junior builds · Full-length front zipper closure · Elasticized cuffs and waist · Stand-up, zip-through collar · Nylon reinforced collar · Two on-seam handwarmer pockets · Sizes: S (6-8), M (10-12), L (14-16), XL (18-20)

NUMBER	DESCRIPTION	SUGG. RETAIL
D ▶ 30466214	Mossy Oak New Break-Up	S-XL \$66.00

JUNIOR TF-300 FLEECE VEST

Midweight fleece with durable, water-repellent Teflon® finish · Cut specifically for junior builds · Full-length front zipper closure · Elasticized waist · Stand-up, zip-through collar · Nylon reinforced collar · Two on-seam handwarmer pockets · Sizes: S (6-8), M (10-12), L (14-16), XL (18-20)

NUMBER	DESCRIPTION	SUGG. RETAIL
E ▶ 30566314	Mossy Oak New Break-Up	S-XL \$53.00

JUNIOR DOWN JACKET

Downproof shell · 650 fill-power goose down insulation · Taffeta lining · Reflective safety patch · Stand-up, zip-through collar · Cut specifically for junior builds · Elasticized cuffs · Two cargo pockets · Sizes: S (6-8), M (10-12), L (14-16), XL (18-20)

NUMBER	DESCRIPTION	SUGG. RETAIL
F ▶ 30476514	Mossy Oak New Break-Up	S-XL \$92.00
G ▶ 30476545	Navy	S-XL 78.00
H ▶ 30476540	Loden	S-XL 78.00



G ▶ Junior Down Jacket, Navy



H ▶ Junior Down Jacket, Loden



A ▶ Jacket
Tan



B ▶ Jacket
Forest



SANTA FE DOWN — HEAVY DUTY WARMTH.

Santa Fe down jackets are designed to withstand the use and abuse that might destroy a lesser down garment. The heavy-duty, highly-constructed Repel-Text™ fabric is treated with a revolutionary new wax finish that sheds water and makes Santa Fe jackets extremely water-resistant. This new treatment adheres to the jacket significantly better than traditional waxing and remains unchanged over time and multiple washings. Santa Fe jackets are also cut longer to give you additional protection from the cold. Knit cuffs seal out drafts. Check out the next generation of down with new Santa Fe jackets.



NEW C ▶ Jacket
Duck Blind®

SANTA FE DOWN JACKET

Water- and wind-resistant Repel-Text shell fabric · 650 fill-power goose down insulation · Down-proof nylon lining · Full-length front zipper flap · Fleece lined, down-filled zip-through collar · Drawcord adjustable bottom · Two lower slash pockets and single inside pocket with zippered closure · Knit cuffs · Sizes: S-3XL

NUMBER	DESCRIPTION	SUGG. RETAIL
A ▶ 30479332	Tan	
	S-XL	\$191.00
		2XL-3XL 210.00
B ▶ 30479341	Forest	
	S-XL	191.00
		2XL-3XL 210.00
C ▶ 30479317	NEW Mossy Oak Duck Blind	
	S-XL	204.00
		2XL-3XL 216.00

THE STAPLE FOR EVERY HUNTER — 650 DOWN.

Down is the ultimate insulator. It is light, compact and extremely warm. For these reasons you should have down as a staple in your gear collection, and you need look no further than Browning. 650 Down jackets and vests make ideal layering garments in frigid, damp conditions and are excellent as a stand-alone piece as well. Their stylish look also makes them suitable to wear around town when the temperatures drop.



NEW
NEW FOR 2010
 All items on this page are also available in Mossy Oak Break-Up Infinity camo.



D ▶ Jacket
 New Break-Up®



E ▶ Jacket
 Duck Blind®



650 DOWN JACKET

Downproof microfiber shell · 650 fill-power goose down insulation · Taffeta lining · Full-length front zipper closure · Stand-up, zip-through collar · Drawcord adjustable bottom · Elasticized cuffs with hook and loop closure · Two lower slash pockets and single inside pocket with zippered closure · Stuffs into included bag · X-Change System compatible · Sizes: S-3XL · Weight: 1 lb. · Center Back Length (L) 28"

NUMBER	DESCRIPTION	SUGG. RETAIL
30475320	NEW Mossy Oak Break-Up Infinity	S-XL \$140.00 2XL-3XL 153.00
D ▶ 30475314	Mossy Oak New Break-Up	S-XL 140.00 2XL-3XL 153.00
E ▶ 30475317	Mossy Oak Duck Blind	S-XL 140.00 2XL-3XL 153.00
30475342	Olive	S-XL 127.00 2XL-3XL 143.00
30475332	Tan	S-XL 127.00 2XL-3XL 143.00
30475390	Black	S-XL 127.00 2XL-3XL 143.00

650 DOWN VEST

Downproof microfiber shell · 650 fill-power goose down insulation · Taffeta lining · Full-length front zipper closure · Stand-up, zip-through collar · Drawcord adjustable bottom · Two lower slash pockets and single inside pocket with zippered closure · Stuffs into included bag · X-Change System compatible · Sizes: S-3XL

NUMBER	DESCRIPTION	SUGG. RETAIL
30575420	NEW Mossy Oak Break-Up Infinity	S-XL \$106.00 2XL-3XL 112.00
30575414	Mossy Oak New Break-Up	S-XL 106.00 2XL-3XL 112.00
30575417	Mossy Oak Duck Blind	S-XL 106.00 2XL-3XL 112.00
30575442	Olive	S-XL 95.00 2XL-3XL 108.00
F ▶ 30575432	Tan	S-XL 95.00 2XL-3XL 108.00
30575490	Black	S-XL 95.00 2XL-3XL 108.00



F ▶ Vest
 Tan



FULL CURL™ WOOL — THE EVOLUTION OF NATURE'S MOST FUNCTIONAL FABRIC.

First there was wool, supremely versatile yet itchy. Then came non-itch wool blends that were just as versatile but more comfortable to wear. Now, we have taken wool to an even higher level with Full Curl Wool, and this wonder fabric has never been more comfortable and effective against the elements. Full Curl combines a durable 7 oz. wool blend outer fabric with the latest technologies like a proven Windcutter™ windproof and water-resistant lamination and soft tricot liner for the ultimate wool fabrication. Fleece side panels are added to increase breathability. The 3-in-1 Parka relies upon another of nature's wonders, down, to provide insulation in the removable liner. The rugged, time-honored performance of wool makes the new Full Curl ideal for nearly all conditions, terrains and activity levels.

ZIPPERED SLASH POCKETS

WINDCUTTER LAMINATE

BELLOWS POCKETS

FLEECE SIDES

NEW

A ► Parka AllTerrain

DETACHABLE HOOD

REMOVABLE DOWN VEST LINER



B ► Jacket AllTerrain

NEW



FULL CURL WOOL 3-IN-1 PARKA

7 oz. wool blend · Windcutter™ laminate blocks wind and provides water-resistance in all but the most extreme weather · Removable down vest · Soft tricot lining · Breathable fleece side panels · Washable · Two upper zippered slash pockets · Two lower bellows pockets with snap closures · Two handwarmer pockets · Zip-off hood · Zip-through collar · Longer parka length · Adjustable cuffs · External storm flap · Browning AllTerrain camouflage pattern · Sizes: S-2XL

NUMBER	DESCRIPTION	SUGG. RETAIL
A ► 30319829	NEW AllTerrain	S-2XL \$216.50

FULL CURL WOOL JACKET

7 oz. wool blend · Windcutter™ laminate blocks wind and provides water-resistance in all but the most extreme weather · Soft tricot lining · Breathable fleece side panels · Washable · Two upper zippered slash pockets · Two handwarmer pockets · Zip-through collar · Adjustable cuffs · Browning AllTerrain camouflage pattern · Sizes: S-2XL

NUMBER	DESCRIPTION	SUGG. RETAIL
B ► 30419829	NEW AllTerrain	S-2XL \$127.00

NEW

C ▶ Pant
AllTerrain



D ▶ Base Layer Shirt
Loden

NEW



E ▶ Base Layer Pant
Loden

NEW



FULL CURL WOOL PANT

7 oz. wool blend · Windcutter™ laminate blocks wind and provides water-resistance in all but the most extreme weather · Soft tricot liner · Washable · Six pocket design · Drawstring cuffs · Button closures on rear and cargo pockets · Browning AllTerrain camouflage pattern · Sizes: S-2XL

NUMBER	DESCRIPTION	SUGG. RETAIL
C ▶ 30219829	NEW AllTerrain	S-2XL \$127.00

FULL CURL WOOL BASE LAYER SHIRT

Comfortable, no-itch Merino wool blend construction · Breathable polyester side panels · Odor reduction from natural anti-microbial properties of wool · Rib knit neck and cuffs · Sizes: S-2XL

NUMBER	DESCRIPTION	SUGG. RETAIL
D ▶ 30119929	NEW Loden	S-2XL \$50.50

FULL CURL WOOL BASE LAYER PANT

Comfortable, no-itch Merino wool blend construction · Odor reduction from natural anti-microbial properties of wool · Rib knit waist and cuffs · Fly opening · Sizes: S-2XL

NUMBER	DESCRIPTION	SUGG. RETAIL
E ▶ 30219929	NEW Loden	S-2XL \$50.50

HIGHLANDS II™ — THE BEST GETS BETTER.

The insulating advantages of wool in cold, wet weather are well known. For time-proven performance combined with today's technology, look to Browning's new Highlands II wool. Highlands II offers additional versatility by taking a wool blend and adding a soft tricot lining for extra warmth and comfort, without the itch usually associated with wool. These versatile products are also machine washable. For 2010, an 11 oz. wool blend makes up the parka and bib, offering the same rugged performance in cold weather. The shirt and pant feature lighter weight 7 oz. wool blend to increase their versatility in warmer temperatures and as layering pieces. There is no substitute for the performance of Highlands II wool.



NEW
A ► Parka
AllTerrain

NEW
B ► Bib
AllTerrain

HIGHLANDS II™

HIGHLANDS II PARKA

Durable, quiet and breathable 11 oz. wool blend outer · Soft tricot lining · Washable · Two upper zippered slash pockets · Two lower bellows pockets with snap closures · Two handwarmer pockets · Zip-off hood · Zip-through collar · Longer parka length · Adjustable cuffs · External storm flap · Browning AllTerrain camouflage pattern · Sizes: S-2XL

NUMBER	DESCRIPTION	SUGG. RETAIL
A ► 30328029	NEW AllTerrain	S-2XL \$165.50
30328029R	NEW AllTerrain, RMEF Embroidery	S-2XL 165.50

HIGHLANDS II BIB

Durable, quiet and breathable 11 oz. wool blend outer · Soft tricot lining · Washable · Zip-to-knee cuff openings with storm flaps · Elasticized suspenders with cam lock buckles · One front zippered pocket · Zippered front opening with two-way zipper and storm flap · Browning AllTerrain camouflage pattern · Sizes: S-2XL

NUMBER	DESCRIPTION	SUGG. RETAIL
B ► 30628029	NEW AllTerrain	S-2XL \$178.00
30628029R	NEW AllTerrain, RMEF Embroidery	S-2XL 178.00



HIGHLANDS II AND THE RMEF.

Elk hunters know what it takes to track down and harvest a big bull. It takes scouting, planning, solid gear and a little luck. Of course, it also takes the help of the Rocky Mountain Elk Foundation. Thanks to the efforts of the RMEF, millions of acres of elk habitat remain viable to sustain these magnificent creatures. As a non-profit organization, the RMEF relies on donations for operation, and Browning is proud to be counted among the companies that support their cause. With each RMEF version of Highlands II wool sold, Browning proudly donates a portion of the proceeds to the RMEF and the mission of supporting the majestic elk.

NEW

C ▶ *Shirt*
AllTerrain



D ▶ *Pant*
AllTerrain

NEW



HIGHLANDS II SHIRT

Durable, quiet and breathable 7 oz. wool blend · Tricot lining provides easy on/off and features OdorSmart™ anti-microbial technology kills odor-causing bacteria to control human odor · Moisture moving treatment wicks away perspiration · Washable · Generously cut, button-up design · Large chest pockets · Button-down collar · Browning AllTerrain camouflage pattern · Sizes: S-2XL

NUMBER	DESCRIPTION	SUGG. RETAIL
C ▶ 30128029	NEW AllTerrain	S-2XL \$101.50
30128029R	NEW AllTerrain, RMEF Embroidery	S-2XL 101.50

HIGHLANDS II PANT

Durable, quiet and breathable 7 oz. wool blend · Tricot lining provides easy on/off and features OdorSmart™ anti-microbial technology kills odor-causing bacteria to control human odor · Moisture moving treatment wicks away perspiration · Washable · Six pocket design · Drawstring cuffs · Button closures on rear and cargo pockets · Browning AllTerrain camouflage pattern · Sizes: S-2XL

NUMBER	DESCRIPTION	SUGG. RETAIL
D ▶ 30228029	NEW AllTerrain	S-2XL \$114.50
30228029R	NEW AllTerrain, RMEF Embroidery	S-2XL 114.50



NEW
NEW FOR 2010
 All items on this page are also available in Mossy Oak Break-Up Infinity camo.



REACTAR

B ▶ Shirt Brush®



C ▶ Shirt Duck Blind®



NEW

D ▶ Shirt Bottomland™



A ▶ Shirt New Break-Up®



WASATCH SHIRT

7 oz., 55% cotton, 45% polyester twill fabric · Seven-button front with long tails · Action back · REACTAR™ pad pocket behind right shoulder (pad sold separately) · Button-down collar · Double-needle side seam construction · Mossy Oak® camo patterns · Adjustable button cuffs and longer sleeve plackets for easier roll-up · Sizes: S-3XL

NUMBER	DESCRIPTION	SUGG. RETAIL
30113520	NEW Mossy Oak Break-Up Infinity	S-XL \$35.00 2XL-3XL 40.00
A ▶ 30113514	Mossy Oak New Break-Up	S-XL 35.00 2XL-3XL 40.00
B ▶ 30113516	Mossy Oak Brush	S-XL 35.00 2XL-3XL 40.00
C ▶ 30113517	Mossy Oak Duck Blind	S-XL 35.00 2XL-3XL 40.00
30113518	Mossy Oak Treestand	S-XL 35.00 2XL-3XL 40.00
D ▶ 30113519	NEW Mossy Oak Bottomland	S-XL 35.00 2XL-3XL 40.00

WASATCH PANT

7 oz., 55% cotton, 45% polyester twill · Deep front pockets · Oversize side cargo pockets with flap and button closure · Drawcord cuffs for snug fit around boots · Adjustable waist tabs for comfortable fit · Rear flap button-through pockets · Sizes: S-3XL, Inseam lengths: S-L 32½", XL-3XL 33½"

NUMBER	DESCRIPTION	SUGG. RETAIL
30213520	NEW Mossy Oak Break-Up Infinity	S-XL \$36.00 2XL-3XL 42.00
30213514	Mossy Oak New Break-Up	S-XL 36.00 2XL-3XL 42.00
30213516	Mossy Oak Brush	S-XL 36.00 2XL-3XL 42.00
30213517	Mossy Oak Duck Blind	S-XL 36.00 2XL-3XL 42.00
E ▶ 30213518	Mossy Oak Treestand	S-XL 36.00 2XL-3XL 42.00
F ▶ 30213519	NEW Mossy Oak Bottomland	S-XL 36.00 2XL-3XL 42.00



E ▶ Pant Treestand®

NEW
F ▶ Pant Bottomland™



G ▶ Long Sleeve T-Shirt
New Break-Up®



NEW

NEW FOR 2010
Also available in Mossy Oak
Break-Up Infinity camo.



H ▶ Short Sleeve T-Shirt
New Break-Up®

NEW

I ▶ 2-Fer T-Shirt
New Break-Up/Black

NEW

NEW FOR 2010
Also available in Mossy Oak
Break-Up Infinity camo.



WASATCH LONG SLEEVE T-SHIRT

100% cotton jersey · Buckmark embroidery · Crew neck design · Mossy Oak® camo patterns · Sizes: S-3XL

NUMBER	DESCRIPTION	SUGG. RETAIL
30112020	NEW Mossy Oak Break-Up Infinity	S-XL \$18.00 2XL-3XL 23.00
G ▶ 30112014	Mossy Oak New Break-Up	S-XL 18.00 2XL-3XL 23.00
30112016	Mossy Oak Brush	S-XL 18.00 2XL-3XL 23.00
30112017	Mossy Oak Duck Blind	S-XL 18.00 2XL-3XL 23.00
30112018	Mossy Oak Treestand	S-XL 18.00 2XL-3XL 23.00

WASATCH SHORT SLEEVE T-SHIRT

100% cotton jersey · Crew neck design · Chest pocket with Buckmark embroidery · Mossy Oak® camo patterns · Sizes: S-3XL

NUMBER	DESCRIPTION	SUGG. RETAIL
30111920	NEW Mossy Oak Break-Up Infinity	S-XL \$15.00 2XL-3XL 18.00
H ▶ 30111914	Mossy Oak New Break-Up	S-XL 15.00 2XL-3XL 18.00
30111916	Mossy Oak Brush	S-XL 15.00 2XL-3XL 18.00
30111917	Mossy Oak Duck Blind	S-XL 15.00 2XL-3XL 18.00
30111918	Mossy Oak Treestand	S-XL 15.00 2XL-3XL 18.00

NEW

J ▶ 2-Fer T-Shirt
New Break-Up/Loden



2-FER T-SHIRT

100% cotton jersey · Crew neck design · Heavyweight body, with lighter weight sleeves · Tribal design logo · Sizes: S-3XL

NUMBER	DESCRIPTION	SUGG. RETAIL
I ▶ 30114799	NEW MONBU/Black	S-XL \$44.50 2XL-3XL 50.50
J ▶ 30114740	NEW MONBU/Loden	S-XL 44.50 2XL-3XL 50.50
K ▶ 30114758	NEW MONBU/Khaki	S-XL 44.50 2XL-3XL 50.50

NEW

K ▶ 2-Fer T-Shirt
New Break-Up/Khaki



WASATCH HOODED SWEATSHIRT

9 oz., 80% cotton, 20% poly fleece · Rib knit cuffs and waistband · Drawcord adjustable hood · Buckmark embroidery · Sizes: S-3XL

NUMBER	DESCRIPTION	SUGG. RETAIL
30143020	NEW Mossy Oak Break-Up Infinity	S-XL \$49.50 2XL-3XL 53.50
30143014	Mossy Oak New Break-Up	S-XL 49.50 2XL-3XL 53.50
30143016	Mossy Oak Brush	S-XL 49.50 2XL-3XL 53.50
A ▶ 30143017	Mossy Oak Duck Blind	S-XL 49.50 2XL-3XL 53.50
30143018	Mossy Oak Treestand	S-XL 49.50 2XL-3XL 53.50

WASATCH HOODED ZIPPERED SWEATSHIRT

9 oz., 80% cotton, 20% poly fleece · Rib knit cuffs and waistband · Full-length front zipper · Drawcord adjustable hood · Buckmark embroidery · Front handwarmer pockets · Sizes: S-3XL

NUMBER	DESCRIPTION	SUGG. RETAIL
30413620	NEW Mossy Oak Break-Up Infinity	S-XL \$53.50 2XL-3XL 58.00
30413614	Mossy Oak New Break-Up	S-XL 53.50 2XL-3XL 58.00
30413616	Mossy Oak Brush	S-XL 53.50 2XL-3XL 58.00
30413617	Mossy Oak Duck Blind	S-XL 53.50 2XL-3XL 58.00
B ▶ 30413618	Mossy Oak Treestand	S-XL 53.50 2XL-3XL 58.00

WASATCH™ CHAMOIS FOR PURE COMFORT.

Soft, breathable and extremely comfortable, Wasatch Chamois is sure to become the first thing hunters reach for. The 9 oz. cotton chamois fabric is rugged and quiet to allow silent stalking in tough conditions and includes the great fit and unique features that have made Wasatch Fieldwear so popular.



NEW

C ▶ Chamois Shirt New Break-Up®

NEW

D ▶ Chamois Pant New Break-Up®

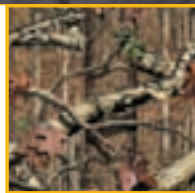

NEW

NEW FOR 2010
All items on this page are also available in Mossy Oak Break-Up Infinity camo.

A ▶ Hooded Sweatshirt Duck Blind®



B ▶ Hooded Zippered Sweatshirt Treestand®



WASATCH CHAMOIS SHIRT

9 oz., 100% cotton chamois · Seven-button front with long tails · Action back · Button-down collar · Double-needle side seam construction · Adjustable button cuffs and longer sleeve plackets for easier roll-up · Sizes: S-3XL

NUMBER	DESCRIPTION	SUGG. RETAIL
30113420	NEW Mossy Oak Break-Up Infinity	S-XL \$50.50 2XL-3XL 57.00
C ▶ 30113414	NEW Mossy Oak New Break-Up	S-XL 50.50 2XL-3XL 57.00

WASATCH CHAMOIS PANT

9 oz., 100% cotton chamois · Deep front pockets · Oversize side cargo pockets with flap and button closure · Drawcord cuffs for snug fit around boots · Adjustable waist tabs for comfortable fit · Rear flap button-through pockets · Sizes: S-3XL, Inseam lengths: S-L 32½", XL-3XL 33½"

NUMBER	DESCRIPTION	SUGG. RETAIL
30213420	NEW Mossy Oak Break-Up Infinity	S-XL \$50.50 2XL-3XL 57.00
D ▶ 30213414	NEW Mossy Oak New Break-Up	S-XL 50.50 2XL-3XL 57.00

REACTAR

REACTAR

E ▶ Long Sleeve Shirt
New Break-Up®

G ▶ T-Shirt
Treestand®

F ▶ Short Sleeve Shirt
New Break-Up®

TRIVENT™



TRI-VENT LONG AND SHORT SLEEVE SHIRTS

Lightweight 3.8 oz., 100% cotton sheeting fabric is perfect for hot weather · Mesh-lined Tri-Vent back allows increased air circulation · Mossy Oak® camo patterns · REACTAR™ pad pocket (pad sold separately) · Padded shoulder patch · Button-down collar · Sizes: S-3XL

NUMBER	DESCRIPTION	SUGG. RETAIL
E ▶ 30114814	Mossy Oak New Break-Up/Long Sleeve	S-XL \$43.00 2XL-3XL 49.00
30114818	Mossy Oak Treestand/Long Sleeve	S-XL 43.00 2XL-3XL 49.00
F ▶ 30114914	Mossy Oak New Break-Up/Short Sleeve	S-XL 38.00 2XL-3XL 43.00
30114918	Mossy Oak Treestand/Short Sleeve	S-XL 38.00 2XL-3XL 43.00

ILLUSION LONG AND SHORT SLEEVE T-SHIRTS

Quick-drying 100% polyester fabric is perfect in hot weather or heavy exertion situations · Moisture-moving fabric moves perspiration away from the body for quick evaporation · Chest pocket · Crew neck · Tagless neck · Sizes: S-3XL

NUMBER	DESCRIPTION	SUGG. RETAIL
30118714	Mossy Oak New Break-Up/Long Sleeve	S-XL \$36.00 2XL-3XL 42.00
G ▶ 30118718	Mossy Oak Treestand/Long Sleeve	S-XL 36.00 2XL-3XL 42.00
30118614	Mossy Oak New Break-Up/Short Sleeve	S-XL 30.00 2XL-3XL 36.00
30118618	Mossy Oak Treestand/Short Sleeve	S-XL 30.00 2XL-3XL 36.00



A ► Big Country Vest
Blaze



BIG COUNTRY VEST

100% polyester fabric · Quiet and durable construction · Reinforced outer seams for durability · Quilted shoulder overlays · Advanced pocket design for carrying accessories · Includes Gear 'Trievers'™ pocket · License tab · Large rear storage area · Sizes: S-3XL

NUMBER	DESCRIPTION		SUGG. RETAIL
A ► 30541501	Blaze	S-3XL	\$64.00

SAFETY VEST

100% polyester Oxford · Zip front · Back license loop · Large snap flap shell pockets · Buckmark embroidery on front and back · Sizes: S-3XL

NUMBER	DESCRIPTION		SUGG. RETAIL
B ► 30510001	Blaze	S-3XL	\$20.00

JUNIOR SAFETY VEST



Cut specifically for junior builds · Sizes: S (6-8), M (10-12), L (14-16), XL (18-20)

NUMBER	DESCRIPTION		SUGG. RETAIL
30550001	Blaze	S-XL	\$18.00

B ► Safety Vest
Blaze



HOODED VEST

100% polyester fabric · Inner side is fleeced for warmth and comfort · Generous cut to fit over heavier clothing · Larger arm openings · Kangaroo pockets · Full-length zipper · Drawcord hood · Rib knit waistband · Sizes: S-3XL

NUMBER	DESCRIPTION		SUGG. RETAIL
C ► 30114201	Blaze	S-XL 2XL-3XL	\$50.00 54.00

HOODED SWEATSHIRT

100% polyester fabric · Inner side is fleeced for warmth and comfort · Generous cut to fit over heavier clothing · Kangaroo pockets · Full-length zipper · Drawcord hood · Rib knit waistband and cuffs · Sizes: S-3XL

NUMBER	DESCRIPTION		SUGG. RETAIL
D ► 30114101	Blaze	S-XL 2XL-3XL	\$58.00 64.00

C ► Hooded Vest
Blaze



D ► Hooded
Sweatshirt
Blaze





E ▶ Zip-Off Sleeve Jacket
Field Tan



BELLOWS POCKETS WITH
EXPANDER SYSTEM



ZIP-OFF SLEEVES



PHEASANTS FOREVER ZIP-OFF SLEEVE JACKET

12 oz., 100% cotton canvas · 100% polyester blaze overlay — over 400 square inches · Zip-off sleeves convert jacket into a vest · Pheasants Forever embroidery · Large bloodproof front load game bag with zip opening for easy cleaning · Shell pockets with the Pocket Expander System for easy conversion to exposed shell loops · Hook and loop pocket flap for easy shell pocket access · D-rings for dog training accessories · Corduroy lined collar · Two zippered front pockets · Two-way front zipper with snap storm flap · Adjustable cuffs · REACTAR™ pad pockets behind each shoulder patch (pad sold separately) · Sizes: S-3XL

NUMBER	DESCRIPTION		SUGG. RETAIL
30411632	Field Tan, with Pheasants Forever logo embroidery	S-XL	\$105.00
		2XL-3XL	117.00
E ▶ 30411932	Field Tan, without embroidery	S-XL	105.00
		2XL-3XL	117.00

PHEASANTS FOREVER® — JOIN THE CAUSE.

Without the conservation efforts of Pheasants Forever, millions of acres of prime pheasant habitat would be lost. Pheasants Forever chapters all over the United States work to protect, restore and enhance wildlife habitat by establishing and maintaining local and regional projects. From encouraging farmers to leave longer wheat stubble, to the purchase of upland habitat land, Pheasants Forever continues to work to preserve America's favorite game bird. To become a member or volunteer, please call toll free (877) 773-2070. With every purchase of a Browning Pheasants Forever product, Browning proudly makes a contribution to this most worthy conservation organization.



A ▶ Vest
Field Tan



REACTAR

B ▶ Bibs
Field Tan



B ▶ Back of bibs
with bloodproof
game bag



C ▶ Pant
Field Tan



PHEASANTS FOREVER VEST

12 oz., 100% cotton canvas · Bloodproof game bag with zip opening · Pheasants Forever embroidery · Shell pockets with the Pocket Expander System for easy conversion to exposed shell loops · Two zippered front pockets · Zipper front · D-rings for dog training accessories · REACTAR™ pad pockets behind each shoulder patch (pad sold separately) · Sizes: S-3XL

NUMBER	DESCRIPTION	SUGG. RETAIL
30511632	Field Tan, with Pheasants Forever logo embroidery	S-XL \$71.00
		2XL-3XL 77.00
A ▶ 30511932	Field Tan, without embroidery	S-XL 71.00
		2XL-3XL 77.00

PHEASANTS FOREVER BIBS

12 oz., 100% cotton canvas · Briar-resistant overlay · Detachable, bloodproof game bag · Pheasants Forever embroidery · Two large front shell pockets with the Pocket Expander System for easy conversion to exposed shell loops · Zipper fly · Waist tabs for size adjustment · Flap rear pockets · Adjustable shoulder straps · Sizes: S-3XL

NUMBER	DESCRIPTION	SUGG. RETAIL
B ▶ 30611632	Field Tan, with Pheasants Forever logo embroidery	S-XL \$101.00
		2XL-3XL 115.00
30611932	Field Tan, without embroidery	S-XL 101.00
		2XL-3XL 115.00

PHEASANTS FOREVER PANT

12 oz., 100% cotton canvas · Briar-resistant overlay · Comfortable, work pant style fit · Deep front pockets · Tool pockets on legs · Zipper fly · Flap rear pockets · Pheasants Forever embroidery · Sizes: Inseam lengths: 30", 32", Waist sizes: 32"-44"

NUMBER	DESCRIPTION	SUGG. RETAIL
C ▶ 30211632	Field Tan, with Pheasants Forever logo embroidery	30" Inseam \$63.00
		32" Inseam 63.00
30211932	Field Tan, without embroidery	30" Inseam 63.00
		32" Inseam 63.00



D ▶ Chaps
Field Tan

F ▶ Strap Vest
Field Tan

NEW

E ▶ Waterproof Chaps
Field Tan



PHEASANTS FOREVER CHAPS

12 oz., 100% cotton canvas · Briar-resistant overlay · Double sized adjustment loops with hook and loop closures · Snap side opening for easy on and off · Pheasants Forever embroidery · Waterproof chaps feature a nylon shell fabric with a breathable, waterproof laminate that prevents water from soaking through the fabric · Sizes: Inseam lengths: 28" Regular, 31" Tall

NUMBER	DESCRIPTION		SUGG. RETAIL
D ▶ 30011632	Field Tan, with Pheasants Forever logo embroidery	28" Inseam	\$51.00
		31" Inseam	63.00
30011932	Field Tan, without embroidery	28" Inseam	51.00
		31" Inseam	63.00
30018432	NEW Field Tan, Waterproof, with Pheasants Forever logo embroidery	28" Inseam	76.00
		31" Inseam	88.00
E ▶ 30018532	NEW Field Tan, Waterproof, without embroidery	28" Inseam	76.00
		31" Inseam	88.00

PHEASANTS FOREVER STRAP VEST

Mesh-back game bag with a breathable, bloodproof laminate in the game bag · Shell pockets with the Pocket Expander System for easy conversion to exposed shell loops · Adjustable shoulder straps · Adjustable front belt with speed buckle · Side adjustment straps · Pheasants Forever embroidery · Front load version allows convenient loading of birds from the front · Sizes: One size fits most on Strap Vest, M/L and XL/2XL on Front Load Strap Vest

NUMBER	DESCRIPTION		SUGG. RETAIL
30511732	Field Tan, with Pheasants Forever logo embroidery	one size	\$63.00
F ▶ 30512032	Field Tan, without embroidery	one size	63.00
30518432	NEW Field Tan, Front Load, with Pheasants Forever logo embroidery	M/L	76.00
		XL/2XL	88.00
G ▶ 30518532	NEW Field Tan, Front Load, without embroidery	M/L	76.00
		XL/2XL	88.00



G ▶ Front Load Strap Vest
Field Tan

NEW



A ► Jacket
Khaki/Loden



B ► Gloves
Khaki/Loden



CROSS COUNTRY WINDCUTTER JACKET

3-layer, 4-way stretch fabric features a hard-faced, abrasion-resistant nylon shell, windproof and water-repellent Windcutter™ laminate middle layer, and soft fleece lining · Highly breathable · Underarm ventilation zippers regulate heat · Two slash pockets, two chest pockets · Drawcord waist · Full-length zipper · Stand-up collar · Sizes: S-3XL

NUMBER	DESCRIPTION	SUGG. RETAIL
A ► 30413040	Khaki/Loden	S-XL \$127.00 2XL-3XL 140.00

CROSS COUNTRY WINDCUTTER GLOVES

Windproof, breathable Windcutter lamination · Dual waterproof leather/synthetic palm provides uncompromising grip and dexterity · Articulated fingers · Sensi-Flex Technology trigger finger for superior feel and articulation · Pull on fit · Sizes: S-2XL

NUMBER	DESCRIPTION	SUGG. RETAIL
B ► 30710358	Khaki/Loden	S-2XL \$38.00



D ► Upland Shirt
Khaki/Blaze

CROSS COUNTRY TECHNICAL PACK VEST

Designed exclusively for Browning by MOTHER™ · Technical backpack-style fit is perfect for long walks with heavier loads · Padded shoulder straps with padded, ventilated waist belt evenly distributes weight · Oversized shell pockets with magnetic closures · Oversized bloodproof game bag · Multiple pockets and pouches organize gear · Rugged 600 denier construction · Sizes: M/L, XL/2XL

NUMBER	DESCRIPTION	SUGG. RETAIL
C ► 30512558	Khaki/Blaze	M/L \$115.00 XL/2XL

CROSS COUNTRY UPLAND SHIRT

100% polyester fabric moves moisture away from the body · Blaze or Loden overlays and shoulder patch · REACTAR™ pad pocket (pad sold separately) · Angled front pocket · Sizes: S-3XL

NUMBER	DESCRIPTION	SUGG. RETAIL
D ► 30119358	Khaki/Blaze	S-XL \$53.00 2XL-3XL 58.00
E ► 30119340	NEW Khaki/Loden	S-XL 53.00 2XL-3XL 58.00

E ► Upland Shirt
Khaki/Loden

NEW

C ► Technical
Pack Vest



Pack Vest, Front



Pack Vest, Shell Pockets



Pack Vest, Side Pockets and Game Bag





GORE-TEX® UPLAND — GET OUT AND HUNT.

Now upland hunters can rely on the waterproof, windproof and breathable protection of Gore-Tex® outerwear. The Gore-Tex Upland Jacket and Pant are designed to keep hardcore hunters in the field and in total comfort, regardless of the weather conditions. The lightweight shell fabric is far from light duty, easily resisting the briars and tugging branches encountered in the field, yet it remains comfortable and flexible to maximize mobility when shouldering a shotgun. The pants feature rugged overlays that make them impervious to the snags that can ruin other waterproof gear. Serious clothing for serious hunters, only from The Best There Is®.



G ▶ Upland Pant
Khaki/Loden



F ▶ Upland Jacket
Khaki/Loden

GORE-TEX® UPLAND JACKET

Highly constructed nylon shell resists abrasions and briars · 100% waterproof Gore-Tex® lining · Full-length zipper with external storm flap · Quilted shoulder pads · Abrasion-resistant sleeve panels · Microfleece inner collar · Two oversized spill-proof bellows pockets and handwarmer pockets · Pocket Expander System · Water-resistant laminated cuffs · Internal game bag with front load access · Sizes: S-3XL

NUMBER	DESCRIPTION	SUGG. RETAIL
F ▶ 30414458	Khaki/Loden	S-XL \$306.00 2XL-3XL 331.00

GORE-TEX® UPLAND PANT

Highly constructed nylon shell resists abrasions and briars · 100% waterproof Gore-Tex® lining · Fully constructed waistband with grip strip waistband and suspender buttons · Differential cut waistband is higher in the back · Waterproof zip to knee cuff · Belt loops · Two front pockets, one rear pocket · Zippered fly · Sizes: S-3XL

NUMBER	DESCRIPTION	SUGG. RETAIL
G ▶ 30214458	Khaki/Loden	S-XL \$229.00 2XL-3XL 255.00

A ► Jacket
Sage/Wheat



C ► Strap Vest
Sage/Wheat



B ► Shirt
Sage/Wheat



D ► Pant
Sage



LYONS HUNT GEAR JACKET

Heavy-duty cotton canvas fabric · Caped front and back yokes for ventilation · Full-length Brass zipper with button-down storm flap · Wool lining · Elastic cuffs with snap adjustment · Sizes: S-2XL

NUMBER	DESCRIPTION	SUGG. RETAIL
A ► 30419558	Sage/Wheat	S-2XL \$109.00

LYONS HUNT GEAR SHIRT

Rugged 100% cotton canvas construction · Shooting patch with REACTAR™ pad pocket (pad sold separately) · Longer sleeve placket for easy roll-up · Patch front pocket with button-down flap · Sizes: S-2XL

NUMBER	DESCRIPTION	SUGG. RETAIL
B ► 30119558	Sage/Wheat	S-2XL \$51.00

LYONS HUNT GEAR STRAP VEST

Rugged 100% cotton canvas construction · Large bloodproof game bag · Two large shell Pockets with flaps · Fully adjustable shoulder straps with brass fasteners · Brass belt buckle · One size fits most

NUMBER	DESCRIPTION	SUGG. RETAIL
C ► 30519558	Sage/Wheat	one size \$61.00

LYONS HUNT GEAR PANT

Heavy-duty cotton canvas fabric · Comfortable carpenter-style cut · Large boot cuff opening · Canvas overlay with rivet reinforcement · Sizes: Inseam lengths: 30", 32", Waist sizes: 32"-42"

NUMBER	DESCRIPTION	SUGG. RETAIL
D ► 30219558	Sage	30" Inseam \$58.00 32" Inseam 58.00



E ▶ Belted Game Bag
Acorn

NEW
G ▶ Game Vest
Blaze



NEW
F ▶ Game Vest
New Break-up®



NEW
NEW FOR 2010
Also available in Mossy Oak
Break-Up Infinity camo.

PRAIRIELANDS BELTED GAME BAG

100% cotton canvas with rubberized mesh pocket to cool game · Extra pockets for choke tubes, sunglasses or dog training transmitter · Pocket for optional 1.5 liter hydration bladder · Game bag has bloodproof lining and mesh sides · Leather belt with brass buckle · Sizes: M (34"-38"), L (38"-43"), XL (44"-49")

NUMBER	DESCRIPTION	SUGG. RETAIL
E ▶ 30910583	Acorn	M-XL \$80.00

BROWNING GAME VEST

100% poly oxford · Front load bloodproof game bag · Elasticized shell loops · Large bellows pockets · Mesh sides and back for lightweight and ventilation · Sizes: S-3XL

NUMBER	DESCRIPTION	SUGG. RETAIL
30517020	NEW Mossy Oak Break-Up Infinity	S-XL \$44.50 2XL-3XL 50.50
F ▶ 30517014	NEW New Break-Up	S-XL 44.50 2XL-3XL 50.50
G ▶ 30517001	NEW Blaze	S-XL 38.00 2XL-3XL 44.50
30517058	NEW Tan	S-XL 38.00 2XL-3XL 44.50





C ▶ Upland Shirt
Light Sage/Loden



Tri-Vent back for
increased air circulation

UPLAND SHIRTS COMFORTABLE FIT FOR DAY-LONG PERFORMANCE.

Countless hours in the field have yielded a line-up of shirts designed to take comfort and durability to the next level. Browning Upland shirts provide you with easy mobility and a bind-free fit when shouldering a shotgun and swinging on game. Of course, these shirts are also stylish enough to look great when worn at your range or club.



A ▶ Overlay Shirt
Dark Khaki/New Break-Up®



B ▶ Overlay Shirt
Dark Khaki/Blaze



D ▶ Upland Shirt
Acorn/Olive



E ▶ Upland Shirt
Olive/Acorn

PRAIRIELANDS CANVAS OVERLAY SHIRT

100% cotton sandwashed canvas · Bi-swing action back for comfort and mobility · Flap-closure pleated chest pocket · 100% cotton Mossy Oak® camo overlays · REACTAR™ pad pocket (pad sold separately) · Antique brass logo snaps · Spread collar · Sizes: S-3XL

NUMBER	DESCRIPTION	SUGG. RETAIL
A ▶ 30111214	Dark Khaki/New Break-Up	S-3XL \$61.00
B ▶ 30112483	Dark Khaki/Blaze	S-3XL 61.00

TRI-VENT UPLAND SHIRT

Lightweight 3.8 oz. sheeting fabric · Mesh lined Tri-Vent back allows increased air circulation · Bi-swing action back for comfort and mobility · REACTAR™ pad pocket (pad sold separately) · Padded shoulder patch · Longer sleeve placket for easy roll-up · Button-down collar · Sizes: S-3XL

NUMBER	DESCRIPTION	SUGG. RETAIL
C ▶ 30111663	Light Sage/Loden	S-XL \$49.00 2XL-3XL 55.00

PRAIRIELANDS UPLAND SHIRT

100% cotton canvas · Contrasting sleeve and shoulder · Bi-swing action back for comfort and mobility · Chest pocket · REACTAR™ pad pocket (pad sold separately) · Padded shoulder patch · Longer sleeve placket for easy roll-up · Button-down collar · Sizes: S-3XL

NUMBER	DESCRIPTION	SUGG. RETAIL
D ▶ 30113742	Acorn/Olive	S-XL \$38.00 2XL-3XL 45.00
E ▶ 30115042	Olive/Acorn	S-XL 38.00 2XL-3XL 45.00

F ▶ Short Sleeve Sand/Olive

NEW



PRAIRIELANDS T-SHIRTS

100% cotton jersey · Cotton twill shoulder patches and sleeve overlays · Crewneck · Rib knit cuffs · Sizes: S-3XL · Short Sleeve, Long Sleeve and Henley styles available

NUMBER	DESCRIPTION	SUGG. RETAIL
F ▶ 30119848	NEW Short Sleeve, Sand/Olive	S-XL \$31.50 2XL-3XL 38.00
G ▶ 30119648	NEW Long Sleeve, Sand/Olive	S-XL 38.00 2XL-3XL 44.50
H ▶ 30119748	NEW Henley, Sand/Olive	S-XL 38.00 2XL-3XL 44.50

UPLAND QUARTER-ZIP SWEATSHIRT

Cotton sweatshirt fleece · Cotton twill shoulder and sleeve overlays · Quarter-zip front with Stand-up collar · Rib knit cuffs and waistband · Sizes: S-3XL

NUMBER	DESCRIPTION	SUGG. RETAIL
I ▶ 30114340	Sand/Olive	S-XL \$58.00 2XL-3XL 64.00

UPLAND HOODED SWEATSHIRT

Cotton sweatshirt fleece · Cotton twill shoulder and sleeve overlays · Hooded design with drawcord · Rib knit cuffs and waistband · Sizes: S-3XL

NUMBER	DESCRIPTION	SUGG. RETAIL
J ▶ 30114140	Sand/Olive	S-XL \$58.00 2XL-3XL 64.00

G ▶ Long Sleeve Sand/Olive

NEW



NEW

H ▶ Henley Sand/Olive

J ▶ Hooded Sweatshirt Sand/Olive



I ▶ Quarter-Zip Sweatshirt Sand/Olive



UPLAND SWEATERS — TRADITION STARTS HERE.

Along with a fine over and under shotgun, a wool sweater should be an integral part of every upland game hunter's wardrobe. Traditional style aside, wool is still one of the most durable and rugged materials available. It also keeps you warm, even if it gets wet. These sweaters are modern versions of old favorites. High wear areas are protected by tough cotton twill overlays. Soft microfleece is strategically placed in the collar area for itch-free comfort. For additional protection both sweaters are available with a protective Windcutter™ laminate to stave off cold winds.

A ► Zippered Sweater
Deep Green



B ► Quarter-Zip Sweater
Deep Green



UPLAND ZIPPERED SWEATER

Warm 100% wool knit · Available with Windcutter™ windproof and water-resistant laminate · Cotton twill shoulder and sleeve overlays · Rib knit cuffs and stand-up collar · Microfleece collar and pocket trim for added comfort · Full front zipper with zip-through collar · Sizes: S-3XL

NUMBER	DESCRIPTION	SUGG. RETAIL
A ► 30014740	Deep Green/with Windcutter	S-XL \$140.00
		2XL-3XL 153.00
30014640	Deep Green/without Windcutter	S-XL 127.00
		2XL-3XL 140.00

UPLAND QUARTER-ZIP SWEATER

Warm 100% wool knit · Available with Windcutter™ windproof and water-resistant laminate · Cotton twill shoulder and sleeve overlays · Rib knit cuffs and stand-up collar · Microfleece collar and pocket trim for added comfort · ¼-length front zipper with zip-through collar · Sizes: S-3XL

NUMBER	DESCRIPTION	SUGG. RETAIL
B ► 30014540	Deep Green/with Windcutter	S-XL \$140.00
		2XL-3XL 153.00
30014440	Deep Green/without Windcutter	S-XL 127.00
		2XL-3XL 140.00



DOUBLE SHOOTING PATCH WITH REACTAR PAD POCKETS

REACTAR

INSULATED SHOOTING JACKET — GO BALLISTIC.

Stay ahead of your shooting competitors by dusting targets year-round in the new Ballistic Shooting Jacket. The waterproof, windproof, breathable Pre-Vent® fabric keeps hardcore shooters dry and protected from the wind while the Thermolite® insulation adds warmth. Oversized shell pockets feature magnetic closures that hold the pocket flaps open or closed.

ZIP-THROUGH COLLAR

THERMOLITE®

WARM THERMOLITE INSULATION

PRE-VENT

PRE-VENT FABRIC

NEW

▶ Shooting Jacket Black/Green

ADJUSTABLE CUFFS

DRAWCORD BOTTOM

TWO-WAY FRONT ZIPPER

BALLISTIC INSULATED SHOOTING JACKET

Pre-Vent® waterproof, windproof, breathable fabric · Warm Thermolite® insulation · Double shooting patch accommodates both right- and left-hand shooters · REACTAR™ pad pockets (pad sold separately) · Two bellows pockets with magnetic fasteners to hold flaps open or closed · Rib knit cuffs · Stand-up, zip-through collar · Brushed tricot lining · Two-way front zipper · Adjustable cuffs with hook and loop closures · Drawcord bottom · Buckmark and Claymaster embroideries · Sizes: S-3XL

NUMBER	DESCRIPTION	SUGG. RETAIL
▶ 30401399	NEW Black/Green	S-3XL \$119.95

Magnetic fasteners hold pocket flaps open.



JOHN M. BROWNING BIOGRAPHY

The essential biography detailing the life and inventions of the greatest firearms inventor the world has ever known · Includes detailed original patent drawings and photographs · Hardcover · 390 pages

NUMBER	DESCRIPTION	SUGG. RETAIL
▶ 12980	John M. Browning Biography	\$37.95

ARS MECHANICA HISTORY

The ultimate history of Fabrique Nationale, one of the world's greatest gunmakers · Illustrated with hundreds of photos, illustrations and technical drawings of FN, Browning, Winchester guns and other products · Makes the perfect gift · Hardcover · 576 pages

NUMBER	DESCRIPTION	SUGG. RETAIL
▶ 12981	Ars Mechanica Book	\$99.95



Back Embroidery



REACTAR

B ▶ Vest
Brown/Tan



C ▶ Vest
Black/Tan

REACTAR



A ▶ Vest
Pine/Tan

REACTAR



BROKEN BIRDS SHOOTING VEST

Mesh body for ventilation · Full-length twill shooting patch with internal REACTAR™ pad pocket (pad sold separately) · Four large shell pockets · Bar tacks at stress points · Side tab adjustments · Large rear pocket for hulls and other gear · Claymaster logo on back · Sizes: S-3XL

NUMBER	DESCRIPTION	SUGG. RETAIL
A ▶ 30502094	Pine/Tan, Right-Hand	S-3XL \$54.95
B ▶ 30502098	Brown/Tan, Right-Hand	S-3XL 54.95
C ▶ 30502099	Black/Tan, Right-Hand	S-3XL 54.95

SXS SHOOTING VEST

Double shooting patch accommodates both right- and left-hand shooters · REACTAR™ pad pockets (pad sold separately) · Polyester MicroSuede® shooting patches · Easy clip side adjustment · Hull bag in back · Notched shoulders for easy movement · Two-way zipper · 3-D Buckmark embroidery on front, Claymaster logo embroidery on back · Sizes: S-3XL

NUMBER	DESCRIPTION	SUGG. RETAIL
D ▶ 30501984	Olive/Brown	S-3XL \$95.95

REACTAR

D ▶ SXS Vest
Olive/Brown



SPORTER DOUBLE ACTION SHOOTING VEST

Mesh body for ventilation · Full-length twill shooting patch with internal REACTAR™ pad pocket (pad sold separately) · Two large shell pockets · Bar tacks at stress points · Button side tab waist · Claymaster logo on back · Sizes: S-3XL

NUMBER	DESCRIPTION	SUGG. RETAIL
E ▶	30502258 NEW Sage/Khaki	S-2XL \$75.95 3XL 82.95
F ▶	30502299 NEW Black/Brown	S-2XL 75.95 3XL 82.95

SPORTER DOUBLE ACTION SHOOTING VEST FOR HER

Polyester mesh front and back · Polyester and cotton twill trim · Full-length quilted shooting patches On right and left shoulders with sewn-in REACTAR™ pad pockets (pad sold separately) · Button tab waist adjustment · Two-way front zipper · Buckmark embroidered pocket and Claymaster embroidered back yoke · Interior security pocket · Sizes: S-2XL

NUMBER	DESCRIPTION	SUGG. RETAIL
G ▶	30506589 Black/Brown	S-2XL \$71.95
H ▶	30506588 Brown/Pink	S-2XL 71.95

SPORTER DOUBLE ACTION JUNIOR SHOOTING VEST

Same features as For Her version but with junior sizing · Sizes: S (6-8), M (10-12), L (14-16), XL (18-20)

NUMBER	DESCRIPTION	SUGG. RETAIL
I ▶	30505589 Black/Brown	S-XL \$59.95
J ▶	30505558 NEW Sage/Khaki	S-XL 59.95



REACTAR

E ▶ Vest Sage/Khaki

NEW



REACTAR

NEW

F ▶ Vest Black/Brown



REACTAR

G ▶ Vest For Her Black/Brown



REACTAR



I ▶ Junior Vest Black/Brown



REACTAR



H ▶ Vest For Her Brown/Pink



REACTAR



NEW

J ▶ Junior Vest Sage/Khaki

SANTA FE PRO SHOOTING VEST

Crazy Horse Leather full-length shooting patch and trim · Cotton twill and polyester mesh body for ventilation · Two-way front zipper · Four large front shell pockets · Bar tacks at all stress points · Back tab adjustments · Large back pocket for empties or other gear · Built-in REACTAR™ pad system · Split shoulder for ease of movement · 100% polyester mesh · Interior security pocket · Sizes: S-2XL

NUMBER	DESCRIPTION	SUGG. RETAIL
A ▶ 30504154	Sage/Oak, Right-Hand	S-2XL \$155.95

DELUXE MESH SHOOTING VEST

Twill full-length shooting patch · Mesh body for ventilation · Two-way front zipper · Four large front shell pockets · Bar tacks at all stress points · Side tab adjustments · Large back pocket for empties or other gear · Built-in REACTAR™ pad system · Split shoulder for ease of movement · 60% cotton, 40% polyester twill · 100% polyester mesh · Sizes: Right-hand S-3XL, Left-hand M-2XL

NUMBER	DESCRIPTION	SUGG. RETAIL
B ▶ 30501779	Charcoal/Brown, Right-Hand	S-3XL \$95.95
C ▶ 30501784	Olive/Tan, Right-Hand	S-3XL 95.95
30502779	Charcoal/Brown, Left-Hand	M-2XL 95.95
30502784	Olive/Tan, Left-Hand	M-2XL 95.95

TRAPPER CREEK CANVAS HALF VEST

Adjustable polyester web belt · Double, oversized shell pockets · Mesh shell pouch with zip bottom For easy emptying · Sizes: One size fits most

NUMBER	DESCRIPTION	SUGG. RETAIL
D ▶ 30900799	Black/Tan	one size \$34.95



A ▶ Vest Sage/Oak



C ▶ Vest Olive/Tan



B ▶ Vest Charcoal/Brown



D ▶ Canvas Half Vest Black/Tan

E ▶ Short Sleeve NTS T-Shirt Sand

NEW



MOHAVE SHORT SLEEVE NTS SHOOTING T-SHIRT

100% polyester moisture-wicking pique fabric is perfect for hot weather · OdorSmart™ technology kills odor-causing bacteria to control human odor · Excellent moisture transfer · Crew neck · Claymaster and Buckmark logo embroidery · Sizes: S-3XL

NUMBER	DESCRIPTION	SUGG. RETAIL
E ▶ 30104348	NEW Sand	S-3XL \$36.95
F ▶ 30104388	NEW Brown	S-3XL 36.95
G ▶ 30104354	NEW Pine	S-3XL 36.95

NEW

F ▶ Short Sleeve NTS T-Shirt Brown



MOHAVE SHORT SLEEVE NTS POLO

100% polyester moisture-wicking pique fabric is perfect for hot weather · OdorSmart™ technology kills odor-causing bacteria to control human odor · Excellent moisture transfer · Rib knit collar · Claymaster and Buckmark logo embroidery · Sizes: S-3XL

NUMBER	DESCRIPTION	SUGG. RETAIL
H ▶ 30104448	NEW Sand	S-3XL \$44.95
I ▶ 30104488	NEW Brown	S-3XL 44.95
J ▶ 30104454	NEW Pine	S-3XL 44.95

G ▶ Short Sleeve NTS T-Shirt Pine

NEW



BADGER CREEK SHORT SLEEVE WOVEN SHOOTING SHIRT

100% garment-washed cotton · Internal REACTAR™ pad pocket behind shooting patch (pad sold separately) · Mesh-lined turbo vent back for maximum air circulation · Seven-button placket front · Button-down collar · Left front patch chest pocket · Sizes: S-2XL

NUMBER	DESCRIPTION	SUGG. RETAIL
K ▶ 30103448	Sand	S-2XL \$44.95
L ▶ 30103488	Brown	S-2XL 44.95
M ▶ 30103454	Pine	S-2XL 44.95

NEW

H ▶ Short Sleeve NTS Polo Sand



M ▶ Short Sleeve Shirt Pine

K ▶ Short Sleeve Shirt Sand

REACTAR



NEW

I ▶ Short Sleeve NTS Polo Brown

NEW

J ▶ Short Sleeve NTS Polo Pine

L ▶ Short Sleeve Shirt Brown





A ▶ Reactar™ Pad

B ▶ Reactar™ Shooting Harness

REACTAR PAD AND SHOOTING HARNESS

REACTAR Shooting Pad: Browning's exclusive REACTAR™ pad (REcoil ACTION ARrestor) absorbs recoil. On the inside of vest, jacket or shirt without altering appearance or increasing length of pull. Only 8.5mm thick. Lightweight. Flexible to form to the body. Uses patented Beta Gel which reduces peak recoil up to 49%. Dimensions: 3¾" W x 7" L.

Harness: Updated for better fit. Includes REACTAR pad. Heavy-duty 500 denier Cordura®. Reversible for use by right- or left-handed shooters. Elastic strap with buckle size adjustment. Sizes: One size fits most.

NUMBER	DESCRIPTION		SUGG. RETAIL
A ▶ 309012	REACTAR Pad, White	one size	\$24.95
B ▶ 309011	REACTAR Harness, Black	one size	44.95

LEATHER TAC-PRO GLOVES

Unique textured palm enhances grip. Made from water- and perspiration-resistant Pittards® leather. Elasticized knuckles add comfort. Adjustable hook and loop closure with Buckmark embroidery. Washable, dries soft. Sizes: S-2XL.

NUMBER	DESCRIPTION		SUGG. RETAIL
C ▶ 30701290	Black	S-2XL	\$69.95

MESH BACK SHOOTING GLOVES

Lightweight, soft brushed synthetic suede. Stretch-mesh back for comfortable fit and enhanced air circulation. Hook and loop closure tab with Claymaster embroidery allows for adjustable, comfortable fit. Washable. Sizes: S-2XL.

NUMBER	DESCRIPTION		SUGG. RETAIL
D ▶ 30701188	Tan/Black	S-2XL	\$29.95
E ▶ 30701190	Black	S-2XL	29.95

TRAPPER CREEK MESH BACK SHOOTING GLOVES

Lightweight, soft brushed synthetic suede. Stretch-mesh back for comfortable fit and enhanced air circulation. Comfortable pull-on style. Washable. Sizes: S-2XL.

NUMBER	DESCRIPTION		SUGG. RETAIL
F ▶ 30701399	NEW Brown/Black	S-2XL	\$24.95

TRAPPER CREEK MESH BACK SHOOTING GLOVES, FOR HER

Lightweight, soft brushed synthetic suede. Stretch-mesh back for comfortable fit and enhanced air circulation. Comfortable pull-on style. Washable. Sizes: S-2XL.

NUMBER	DESCRIPTION		SUGG. RETAIL
G ▶ 30701488	NEW Brown/Pink	S-2XL	\$24.95

SHOOTING TOWEL

Luxuriously soft 100% cotton terry fabric. Metal eyelet and towel hanger. Buckmark embroidery.

NUMBER	DESCRIPTION		SUGG. RETAIL
H ▶ 30030073	Black		\$13.95



C ▶ Leather Tac-Pro Gloves Black



D ▶ Mesh Back Shooting Gloves Tan/Black



E ▶ Mesh Back Shooting Gloves Black



NEW

G ▶ Trapper Creek Shooting Gloves For Her, Brown/Pink



H ▶ Shooting Towel

NEW

F ▶ Trapper Creek Shooting Gloves Brown/Black

CAPS — THE RIGHT CAP FOR EVERYONE.

You can always use another cap to shade your eyes from the sun, keep you warm in the cold weather or just hide a bad hair day. Our stylish caps are always comfortable, constructed of the finest materials and feature unique and attractive Buckmark logos. We offer a wide selection of Mossy Oak® camo pattern caps, plus lightweight designs to keep you cool and looking great during the summer shooting competition months. Enjoy the comfortable fit and feel of a Browning cap while proudly displaying your favorite brand.



NEW
NEW FOR 2010
 Many items on this page are also available in Mossy Oak Break-Up Infinity camo. See chart for details.



HATS/CAPS

NUMBER	DESCRIPTION	SUGG. RETAIL
BREEZE MESH BACK CAP		
A ▶ 308325141	NEW MONBU/Tan Hook and Loop Back	\$9.95
308325201	NEW MOINF/Tan Hook and Loop Back	9.95
GUNNER CAP		
B ▶ 308129141	NEW MONBU/Black Flex Fit®	17.95
C ▶ 308129142	NEW MONBU/Pink Hook and Loop Back	17.95
RIDGEWAY 2 TONE CAP		
D ▶ 308324141	NEW Black/MONBU Hook and Loop Back	14.95
308324201	NEW Black/MOINF Hook and Loop Back	14.95
EASTFORK CAP		
E ▶ 308125141	MONBU Hook and Loop Back	14.95
308125201	NEW MOINF Hook and Loop Back	14.95
F ▶ 308125181	MOTS Hook and Loop Back	14.95
G ▶ 308125141R	NEW RMEF MONBU Hook and Loop Back	14.95
308125201R	NEW RMEF MOINF Hook and Loop Back	14.95
H ▶ 308125181R	NEW RMEF MOTS Hook and Loop Back	14.95
3-D BUCKMARK LOW PROFILE CAP FOR HER		
I ▶ 308179142	MONBU/Pink Hook and Loop Back	14.95
308179202	NEW MOINF/Pink Hook and Loop Back	14.95
CAMO CAP WITH 3-D ARCH LOGO		
J ▶ 308498141	MONBU Hook and Loop Back	14.95
308498201	NEW MOINF Hook and Loop Back	14.95
CAMO CAP WITH 3-D BUCKMARK		
K ▶ 308479141	MONBU Hook and Loop Back	14.95
308479201	NEW MOINF Hook and Loop Back	14.95
L ▶ 308479161	MOBR Hook and Loop Back	14.95
M ▶ 308479171	MODB Hook and Loop Back	14.95
N ▶ 308479181	MOTS Hook and Loop Back	14.95
CAMO RIFFRAFF CAP WITH BUCKMARK		
O ▶ 308218141	MONBU Leather Strap Buckle Back	14.95
308218201	NEW MOINF Leather Strap Buckle Back	14.95
BIG BUCKMARK AND CAMO CAP		
P ▶ 308204141	MONBU/Black Hook and Loop Back	14.95



QuikCamo



NEW

NEW FOR 2010
Also available in Mossy Oak
Break-Up Infinity camo.



QUIK CAMO™ FACE MASK CAP

Brushed tricot fabric is quiet when moving through brush - Patent pending design features a drop down mesh face mask that hides the face quickly and easily - Face mask uses quick-drying, moisture-wicking breathable fabric - Eyewear compatible - Ear holes for unobstructed hearing - Mouth port for call access - Adjustable back - MODB cap has ear flaps - Buckmark embroidery

NUMBER	DESCRIPTION	SUGG. RETAIL
A ▶ 308128141	NEW MONBU Hook and Loop Back	\$34.95
308128201	NEW MOINF Hook and Loop Back	34.95
B ▶ 308128171	NEW MODB Hook and Loop Back	39.95



HATS/CAPS

NUMBER	DESCRIPTION	SUGG. RETAIL
NEEDLES CAMO A.T. WITH BUCKMARK CAP		
C ▶ 308323241	NEW Pink Hook and Loop Back	\$14.95
D ▶ 308323291	NEW Green Hook and Loop Back	14.95
TATTER ALL TERRAIN CAMO FELT BUCKMARK CAP		
E ▶ 308119241	Pink Plastic Snap Back	9.95
F ▶ 308119291	Green Plastic Snap Back	9.95
WOODLAND CAMO CAP		
G ▶ 308121411	Pink Leather Strap Buckle Back	14.95
H ▶ 308121841	Green Leather Strap Buckle Back	14.95
DIGI CAMO CAP		
I ▶ 308506281	Digi Forest Hook and Loop Back	14.95
J ▶ 308506291	Digi Desert Hook and Loop Back	14.95
EASTFORK BLAZE CAP		
K ▶ 308125011	Blaze/Black Hook and Loop Back	14.95
L ▶ 308125011R	NEW RMEF Blaze/Black Hook and Loop Back	14.95
SAFETY PHEASANTS FOREVER EMBROIDERY CAP		
M ▶ 308126011	Blaze Hook and Loop Back	14.95
SAFETY PLUS WITH 2 STRIPE BRIM CAP		
N ▶ 308117011	Blaze Hook and Loop Back	14.95
SAFETY CAP WITH 3-D BUCKMARK		
O ▶ 30840501	Blaze/Black Hook and Loop Back	14.95
SAFETY PLUS CAP WITH 3-D BUCKMARK		
P ▶ 308461001	Blaze/Yellow Hook and Loop Back	14.95





NEW

Q



NEW

R



NEW

S



NEW

T



NEW

U



V



W



NEW

X

HATS/CAPS

NUMBER	DESCRIPTION	SUGG. RETAIL
GRIZZLY HEAVYWEIGHT DUCK CAP		
Q ▶ 308414381	NEW Olive Hook and Loop Back	\$17.95
R ▶ 308414681	NEW Field Tan Hook and Loop Back	17.95
S ▶ 308414841	NEW Olive/Field Tan Hook and Loop Back	17.95
T ▶ 308414681R	NEW RMEF Field Tan Hook and Loop Back	17.95
LITE WAX CAP WITH CORPORATE LOGO		
U ▶ 308412581	NEW Khaki Hook and Loop Back	17.95
DURA WAX CAP		
V ▶ 3084121	Brown Hook and Loop Back	17.95
W ▶ 308412381	Olive Hook and Loop Back	17.95
X ▶ 308412511	NEW Brown/Pink Hook and Loop Back	17.95
DURA WAX CAP WITH 3-D BUCKMARK		
Y ▶ 308412881	Brown Hook and Loop Back	17.95
REPEL-TEX CLOTH 2 TONE CAP WITH 3-D BUCKMARK		
Z ▶ 308110341	Acorn/Olive Hook and Loop Back	17.95
REPEL-TEX CAP WITH 3-D BUCKMARK		
AA ▶ 308110681	Acorn Hook and Loop Back	17.95
REPEL-TEX CAP 2 TONE WITH DUCKS		
BB ▶ 308122341	Acorn/Olive Hook and Loop Back	17.95
REPEL-TEX CAP 2 TONE WITH WHITETAIL		
CC ▶ 308122941	Olive/Acorn Hook and Loop Back	17.95
WASHED MICRO SUEDE CAP WITH 3-D BUCKMARK		
DD ▶ 308312441	Moss Hook and Loop Back	14.95
EE ▶ 308312681	Tan Hook and Loop Back	14.95
STRAW CAP WITH REPEL-TEX BRIM		
FF ▶ 308106881	Brown Hook and Loop Back	19.95



Y



Z



AA



BB



CC



DD



EE



FF



A



B



C



D



E



F



G



H



I



J



K

HATS/CAPS

NUMBER	DESCRIPTION	SUGG. RETAIL
FLEXFIT TALON PIQUE CAP WITH BUCKMARK		
A ▶	308007991 NEW Black Flex Fit®	\$17.95
TWILL CAP WITH 3-D BUCKMARK AND PIPE BRIM		
B ▶	308304211 Pink/Brown Hook and Loop Back	14.95
C ▶	308304381 Wheat Hook and Loop Back	14.95
D ▶	308304521 Terra Cotta Hook and Loop Back	14.95
E ▶	308304681 Mocha Hook and Loop Back	14.95
F ▶	308304711 Red Hook and Loop Back	14.95
G ▶	308304791 Charcoal Hook and Loop Back	14.95
H ▶	308304841 Olive Hook and Loop Back	14.95
ASPEN MOTTLED CAP		
I ▶	308225541 Sage Hook and Loop Back	14.95
J ▶	308225881 Brown Hook and Loop Back	14.95
FLEX FIT STRETCH LOGO BRIM TIP CAP		
K ▶	308224611 Black/Red Flex Fit®	17.95
L ▶	308224621 Black/Orange Flex Fit®	17.95
M ▶	308224841 Black/Olive Flex Fit®	17.95
N ▶	308224881 Black/Brown Flex Fit®	17.95
WICHITA CONTINUOUS STITCH CAP		
O ▶	308226791 Charcoal Hook and Loop Back	14.95
P ▶	308226841 Pine Hook and Loop Back	14.95
BISMARCK LITE FELT HAT		
Q ▶	308280281 Woods Size: S-M	69.95
Q ▶	308280282 Woods Size: L-XL	69.95
BISMARCK LITE FELT OVERDYE HAT		
R ▶	308280881 Pecan Size: S-M	69.95
R ▶	308280882 Pecan Size: L-XL	69.95



L



M



N



O



P



Q



R

BROWNING PRO STAFF



JOHNNY MEITZEN started shooting competitively in 1987 and is currently a NSCA Level III instructor. He has won a number of shooting titles including: Two-time NSCA Nationals Vet Champion, two-time NSCA Nationals FITASC Vet Champion. Johnny is also a six-time All-American Sporting Team member, two-time Team USA Sporting member and two-time Team USA FITASC member. He also has many state and zone championship titles to his credit. Johnny is a die-hard Citori® man. His current model of choice is the Citori 625 Sporting.



RICK CAMUGLIA is a long-time Browning shooter with multiple sporting clays titles, nearly all won with Browning autoloading shotguns. A short list of his victories includes multiple National and Regional FITASC Championships, nine-time New Mexico State Champion, two-time HOA Arizona State Champion and two-time HOA Colorado State Champion. He is also an eight time NSCA All-American Team member. Rick prefers to shoot the new Maxus® autoloader.

DEEANN MASSEY was introduced to sporting clays shooting by her husband Jeff, who taught her to shoot in their backyard. She shot in her first tournament in the summer of 1996. In 1997, ten days before the Sporting Clays National Championship, she purchased her first 12 gauge Browning Gold. She used the Gold to tie for Ladies High Overall. Since then she has won two National Championships and has been a five-time runner-up. She has been on the 1st All American Team twelve times and Team USA seven times. She has also won the Michigan State Ladies Championship twelve times, the Zone Three Ladies Championship ten times and has numerous other wins in local and regional competition. She has been a member of the Browning Pro Staff Team for eleven years. DeeAnn currently shoots the Cynergy over and under.



BROWNING PRO STAFF



ROBBIE PURSER started shooting skeet at the tender age of six. Over the years he has accumulated an impressive list of shooting titles including: 1980 World Skeet Champion, 1991 and 1998 NSCA Champion, Zone 4 Champion, Quail Unlimited Champion, four-time Ducks Unlimited Champion, 2002 Sportsman Team Challenge Champion and an ESPN Great Outdoor Games gold medalist. He is also a twelve-time All-American Team member, a member of Team USA and a ten-time Georgia State Champion. All told, Robbie has more than 200 tournament wins to his credit — all with Browning autoloaders.



When **ZAC COOPER** was born, his parents decided that instead of giving up hunting for a while, they would take Zac with them. So at four months of age, Zac was on a plane to Iowa for a whitetail hunt. He took his first deer at an early age, accompanied by his father and hunting has since become a way of life for Zac. Now thirteen, Zac has gained national recognition for his speaking ability. He has been a guest speaker at such events as the 2009 QDMA National Convention, the University of Florida's Field Day, the Sportsman's Spectacular, and Florida's National Field Day. Zac is also a leader in school, serving in student government while maintaining straight-A grades. Zac has two long-term goals: To be a positive influence on today's youth and to help get them into the sport of hunting. See him in his debut hunting DVD titled "Little Man, Big Dreams."



Pound for pound, **MATT HUGHES** is the toughest fighter in the Ultimate Fighting Championship® ranks. Since entering the UFC in 1996, Matt has amassed a record of 44 wins with a mere seven defeats, and is a nine-time Welterweight World Champion with the most title defenses in UFC history. He is also a long-time fan of Browning firearms. When he's not in training for his next fight or working on his Illinois farm, you'll find Matt hunting birds and winning shooting competitions with his Citori® or chasing deer and wild hogs with his A-Bolt® and X-Bolt® rifles.



STEPHEN LEBLANC is a man of many talents. He has a degree in wildlife biology, is a master taxidermist, an award-winning wildlife sculptor and an avid hunter. His impressive list of talents, coupled with an easy going, personable demeanor made him the perfect candidate to host our new television program "Browning Expeditions." His impressive hunting résumé includes a North American Grand Slam of sheep and the Africa Big Five that consists of elephant, rhino, cape buffalo, lion and leopard.





WE OUTFIT YOU AND YOUR RIDE



Providing "The Best There Is" with our lines of Casual Apparel, Automotive Accessories, Signature Jewelry and Gifts.



Hoodies • Tees • Jeans • Jackets • Ladies • Youth • Pendants • Wallets • Games • Belt Buckles
Watches • Seat Covers • Floor Mats • Decals • License Plate Frames • Steering Wheel Covers



For Sales Information:
www.browningcs.com
1-888-235-4078



BROWNING
FOOTWEAR

The Best There Is®

1.800.441.4319

www.browningfootwear.com



BROWNING

- Hunting Socks
- Boot Socks
- Casual Socks
- Work Socks
- Western Boot Socks
- Heavy Wool Socks
- Performance Socks
- Ladies Socks
- Kids Socks
- Made in USA

Browning Hosiery Sock Collection



**Comfort and Protection for all Hunting, Hiking,
Work, and Casual Settings**

Carolina Hosiery Mills

tel 336.226.5581 | fax 336.226.9721 | www.browninghosiery.com



BROWNING
EYEWEAR AND ACCESSORIES

*YOU KNOW BROWNING MAKES THE BEST SHOOTING GLASSES.
NOW YOU CAN WEAR BROWNING CASUAL EYEWEAR
AFTER YOU LEAVE THE RANGE.*

(Shooting glasses are found on page 134)



Browning Eyewear and Accessories offer fashionable eyewear styles that allow the wearer to sport the Buckmark around town while protecting their vision from harmful UV rays. ®

The Elite series offer fashion conscious TR90 frames with clear distortion free CR39 lens. The Armour series offers durable Polycarbonate frames with our soft touch finish and TAC lens. The durable frames and polarized lenses offer maximum comfort to minimize eye strain. A line of branded accessories is also available.

See the full line of Browning Eyewear and Accessories at
www.browningeyewear.com
800.416.0866



BROWNING
OUTDOOR COOKWARE

Built on the Browning principal of "The Best There Is" the Smoke Vaults carry that mantra into outdoor cooking equipment. With each Smoke Vault sporting a 20,000 BTU burner, the smoking and cooking options are limitless. Up to five racks can be filled with any food and smoked to perfection. This is one item that will become indispensable no matter the outing, back country or back patio. Ask for it at your local Browning dealer.



BROWNING SMOKERS

SMV245B

- 18" And 24" Sizes To Accommodate Any Size Group
- 20,000 BTU Cast Iron Burner
- Cast Iron Chip Tray
- Numerous Accessories Available
- Built In Igniter



Made Exclusively By:



Smokers, Stoves, Dutch Ovens and Skillets also available at www.BrowningOutdoorCookware.com

Browning Gourmet Kitchens® The Best There Is™
Lifetime Cutting Boards



Bamboo
Wood

Corian®
Solid Surfacing



Order Online:
www.LifetimeCuttingBoards.com



Tow & Stow™ Receiver Hitch

- Multiple Ball Sizes: 2 5/16", 2" & 1 3/8"
- Available in 3 adjustment lengths
- Raise or lower the hitch for a safe level tow
- Manufactured from steel
- Powder coated for a durable and long lasting finish
- 10,000 lbs. Trailer Weight /1,000 lbs. Tongue Weight



BROWNING
HITCHES



www.turnoverball.com
800.248.6564



BROWNING FISHING

Check out the new line of equipment from **Browning Fishing in 2010.**

Topping off the broad range of rods and reels are state-of-the-art models that offer exceptional casting distance and accuracy, second-to-none sensitivity and extreme longevity, all appointed with superior workmanship and finish details. Spinning and baitcast rods and reels serve every skill level and include the species specific **Six Rivers** rod series and multi-piece **Safari** travel rods, as well as balanced combo models, round out this great new line of fishing gear.

BP402429

FEED YOUR FEVER

GET GEAR PERFECT FOR ANY KIND OF FISHING



Browning® Tuto

It's our biggest, most complete fishing bag yet! Features include: Large storage compartment for eight 370 utility boxes (included) • Heavy-duty 1200 denier polyester construction • Finger pull zippers • Zip-down front panel • Rainfly compartment • Leather-reinforced stress points • Visual storage for personal items • Padded strap • 4 non-skid foot pads • Terminal & accessory storage • Color: Green/Gray • Size: 23"x15"x15" • Imported

Browning® Six Rivers Pack Combo

This outfit is ideal for the saddlebag, golf bag, carry-on or canoe. It travels great and has room in the case for a box of your best lures. With just minimum care and lubrication, it will serve you for years. The reel has 6 bearings, Powerlock™ instant anti-reverse, a 5.1:1 gear ratio and holds 160 yds. of 6-lb. line. The 5-pc., 6' 6" graphite rod has 6 Fuji® aluminum oxide guides and is rated for 2-8 lb. line and 1/16-1/8-oz. lures. Takedown length is just under 20".

FOR INFORMATION, PLEASE CALL: 1-800-227-7776
WWW.BROWNINGFISHING.COM

BROWNING ARCHERY INTRODUCES FIELD READY BOWS!



FIELD READY

- All bows are available fully preassembled with the finest accessories including a release aid and a bow case
- There is no specialized equipment or archery expertise required
- Bows are pre-tuned by experienced archery technicians
- All arrows are cut to length with nocking points and inserts installed

WWW.BROWNING-ARCHERY.COM
1.800.477.7789

Browning Archery is distributed in Canada by Porcupine Creek Supply, Calgary, Alberta 403-237-8007 www.archerysupplies.com



BROWNING
ARCHERY
BROWNING TRADemarks LICENSED FROM BROWNING



Browning has a rich tradition of providing exceptional products for the avid outdoorsman, and the Browning Camping line is no exception. Our furniture is wider & stronger, our pads & mats are thicker and more comfortable, and our tents & sleeping bags use larger zippers and better fabric.



The Best There Is®

1.877.459.2825
www.browningcamping.com

Sleeping Bags • Furniture • Tents • Air Pads

800 MAG
700 FPS!



Introducing the Browning 800 MAG. Anti-recoil power system, fiber optic sights, and ambidextrous ergonomic pistol grip make this break barrel pellet pistol a must have. Ask for the Browning 800 MAG.





When going afield, take
The Best There Is...
take Browning.



www.browningbags.com

Cerf Bros. Bag Co. • 2360 Chaffee • St. Louis, MO 63146 • (800) 237-3224

Browning...for the way you live

Browning Outdoor Health and Safety Products incorporate the quality craftsmanship and dependability hunters have come to expect from Browning. Each item is specifically designed to offer performance in extreme conditions.

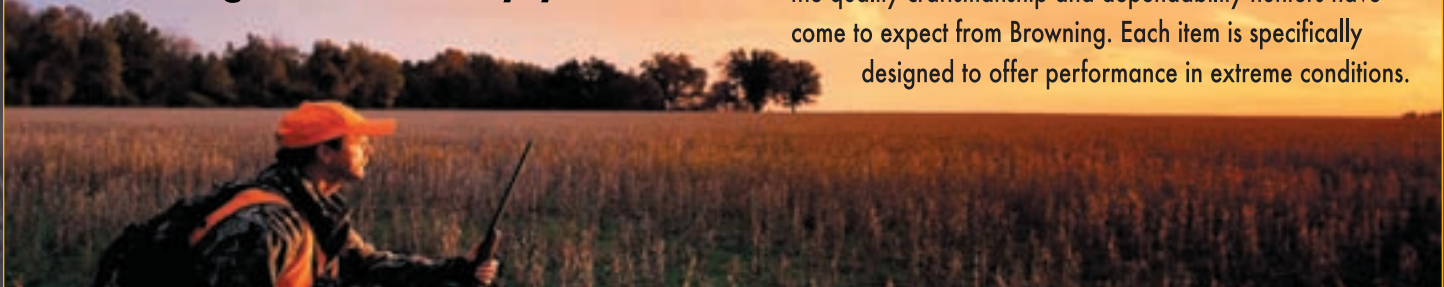

First Aid Kits



Outerwear
Water Repellent



For more information on our complete line of Browning Outdoor Health & Safety Products
call 1-800-558-6614 or online at www.BrowningSupplies.com

OUT HERE
 IT'S WHAT HELPS YOU GO WHERE THE
 GAME GOES.



SPORTSMAN® XP
 BROWNING® LIMITED EDITION

Browning makes The Best There Is® and only partners with the best. Which is why Browning and Polaris® came together to make the Sportsman XP Browning Limited Edition. With hand and thumb warmers, 3.0 winch, and a Lock & Ride® gun scabbard, plus its standard 70 horsepower* and 360-lb. rack capacity, it's built for Xtreme Performance. In other words, it's built like a Sportsman. Visit browningoffroad.com.



Vehicle shown with optional equipment. *850 EFI model. WARNING! ATVs can be hazardous to operate. For your safety, always wear a helmet, eye protection, and protective clothing and never carry passengers unless the adult ATV has been designed by the manufacturer specifically for that purpose. Polaris adult models are for riders aged 16 and older. Be sure to take a safety training course. For safety and training information in the U.S., call the SVIA at (800) 887-2887. You may also contact your Polaris dealer or call Polaris at (800) 342-3764. For safety and training information in Canada, contact your local Polaris dealer. ©2009 Polaris Industries Inc. Browning®, The Best There Is, and BROWNING Design are the registered trademarks of Browning Corporation.

PRSRTP BPM
U.S. POSTAGE PAID
PERMIT 179
OGDEN, UT

BROWNING
ONE BROWNING PLACE
MORGAN, UT 84050

BE A SAFE SHOOTER Read and follow all safety information in the owner's manual provided with each firearm before using the firearm. Additional copies are available for free download on the Browning website. Browning endeavors to make the safest firearms possible, however, firearm safety begins with you. At all times treat any firearm with intense respect for its power and potential danger. Always point the muzzle in a safe direction. There is no excuse for careless or abusive handling of any firearm.



BROWNING IS COMMITTED TO SERVING YOU Every effort has been made to ensure that all product photographs, descriptions and specifications in this workbook are accurate; however, inadvertent errors may occur. Changes in design or materials due to our continual effort to improve products may result in specification changes before subsequent publications are issued. Browning reserves the right to modify or change specifications without notice. If you have any questions regarding Browning products, please write to Browning, One Browning Place, Morgan, UT 84050-9326.



BROWNING[®]

Browning ▶ One Browning Place ▶ Morgan, UT 84050-9326
Distributed in Canada by: Browning Canada Sports Ltd./Ltée
5583 Chemin St-François ▶ St-Laurent, Quebec H4S 1W6

BROWNING.COM **800-333-3288**

©Copyright, Browning, December 2009. No part of this catalog may be reproduced without the written permission of Browning.
Printed in U.S.A. GAC0912200/09482